

TECHNICAL CHARACTERISTICS

MATERIAL  
 INSULATOR: PBT  
 COLOR: WHITE  
 CONTACT MATERIAL: COPPER ALLOYS  
 CONTACT TYPE: STAMPED  
 CONTACT PLATING: SELECTIVE GOLD  
 SHIELDING: BRASS Ni PLATED  
 QUALITY CLASS: 1500 MATING CYCLES

ENVIRONMENTAL  
 OPERATING TEMPERATURE: -40 UP TO 105°C  
 FLAMABILITY RATING: UL94-V0  
 COMPLIANCE: LEAD FREE AND ROHS

ELECTRICAL  
 CURRENT RATING:  
 - PIN 1 & PIN 4 (Vbus & corresponding ground PIN) 1.8A Max  
 - OTHER PINS 0.25 A min  
 WORKING VOLTAGE: 30V  
 INSULATOR RESISTANCE: >1000 MOHM  
 DIELECTRIC WITHSTANDING VOLTAGE: 750V AC/MN  
 CONTACT RESISTANCE: 20 mOHM MAX

STANDARD  
 CERTIFIED: E323964 / MODEL NUMBER 614-x350

SOLDERING  
 WAVE PROCESS ONLY

PACKAGING  
 TRAY

RoHS Compliant

G	22-JUN-11	CURRENT RATING	GG
F	08-JUL-10	PACKAGING	JC
E	19-NOV-09	STANDARD	JP
D	23-JUL-09	NEW DRAW	CH
C	10-DEC-07	MODIFICATIONS	EC
B	13-MAR-07	NEW DRAW	JP
A	03-NOV-06	PDF	JP
REV	DATE	FILE	BY

PROJECTION:

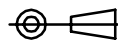

APPROVAL: RJ

GENERAL TOLERANCE

.X = +/- 0.2  
 .XX = +/- 0.15



UNIT: MM

SCALE:

SHEET: 1/2

DRAW: PEARL

DESCRIPTION: USB TYPE A VERTICAL

WERI PART NO: 614 004 135 023

SIZE

**A4**

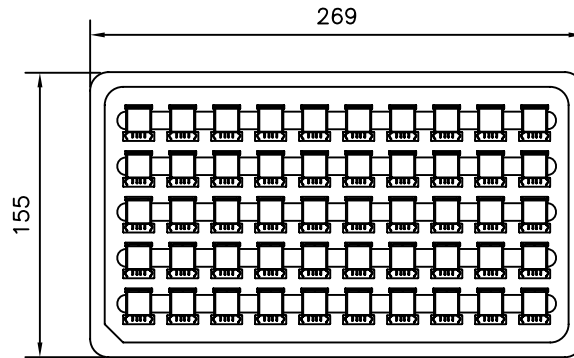
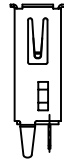
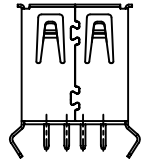
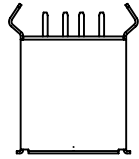
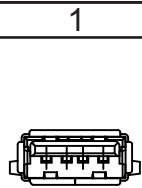

Note:  
 1.Dimension:  
 Tray Size: 269(L)X155(W)X8.0(H) (mm)  
 Carton Size:322X285X350(mm)

Pin.	Pcs/Tray	Tray/Carton	Pcs/Carton
04	50	70	3500

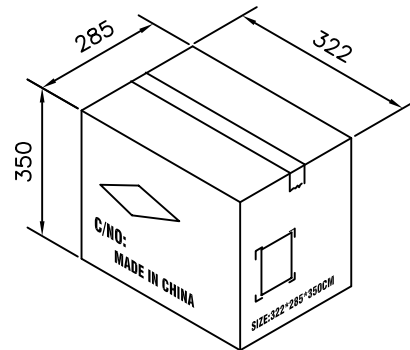
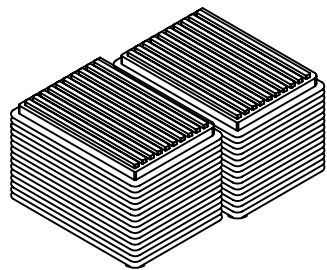

84 Trays

RoHS Compliant			
G			
F			
E			
D			
C			
B			
A			
REV	DATE	FILE	BY

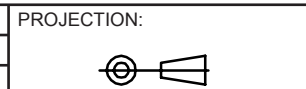

GENERAL TOLERANCE  
 .X = +/- 0.2  
 .XX = +/- 0.15



APPROVAL: RJ

UNIT: MM  
 SCALE:  
 SHEET: 1/2  
 DRAW: PEARL

DESCRIPTION: USB TYPE A VERTICAL  
 WERI PART NO: 614 004 135 023

SIZE  
**A4**