

REVISIONS

DCP #	REV	DESCRIPTION	DRAWN	DATE	CHECKD	DATE	APPRVD	DATE
1891	A	RELEASED	EO	06/27/06	SA	7/25/06	HO	7/25/06

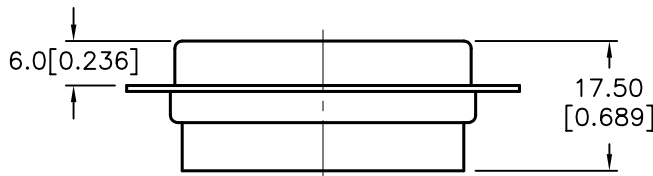

DB25(M)

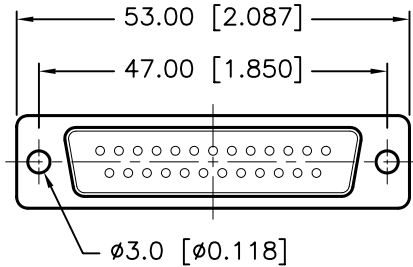
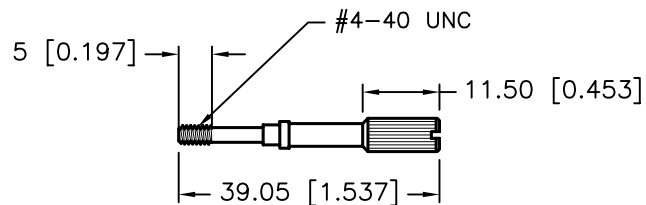
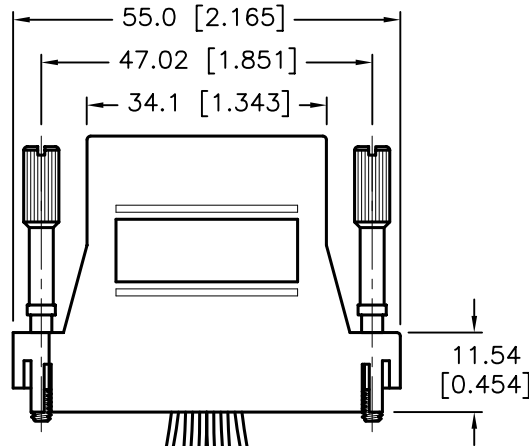
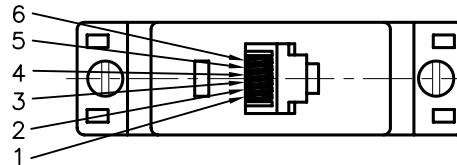

FRONT VIEW OF 8P6C TELEPHONE JACK

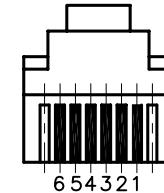

6 5 4 3 2 1
WIRE SYSTEM

1	2	3	4	5	6
WHITE	BLACK	RED	GREEN	YELLOW	BLUE

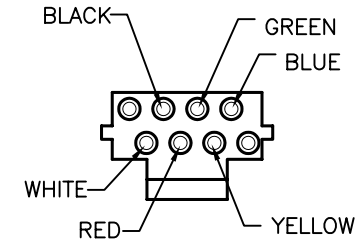
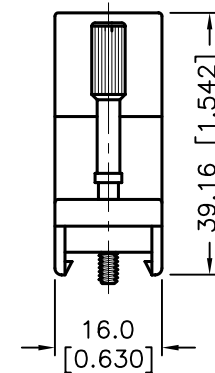

SPECIFICATION:

- D-Sub Connector: Tin-Plated Shell. with Black Color Insulator.
- Contact:
 - D-Sub: Phosphor Brass, Gold-Plated.
 - RJ12: Brass, Gold-Plated.
- Body: ABS, Ivory (Beige) Color.
- Thumb Screw: Steel, Nickel-Plated.
- Electronic Wire: UL1061, 26AWG.

DISCLAIMER:
ALL STATEMENTS AND TECHNICAL INFORMATION CONTAINED HEREIN ARE BASED UPON INFORMATION AND/OR TESTS WE BELIEVE TO BE ACCURATE AND RELIABLE. SINCE CONDITIONS OF USE ARE BEYOND OUR CONTROL, THE USER SHALL DETERMINE THE SUITABILITY OF THE PRODUCT FOR THE INTENDED USE AND ASSUME ALL RISK AND LIABILITY WHATSOEVER IN CONNECTION THEREWITH.

TOLERANCES:

Unless Otherwise Specified

.X	±0.2 [0.008]
.XX	±0.12 [0.005]

DRAWN BY:	DATE:
EKLAS ODISH	06/27/06
CHECKED BY:	DATE:
SAMI ALNADI	7/25/06
APPROVED BY:	DATE:
HISHAM ODISH	7/25/06

DRAWING TITLE: Telephone Adapter, DB25 Male to RJ12, 6 Conductors			
SIZE	DWG. NO.	ELECTRONIC FILE	REV
A	SPC19778	84K8542.DWG	A
SCALE: NTS		U.O.M.: mm [INCHES]	SHEET: 1 OF 1