

## 3.3 V and 2.5 V LVCMOS High-Performance Clock Buffer Family

Check for Samples: [CDCLVC11xx](#)

### FEATURES

- High-Performance 1:2, 1:3, 1:4, 1:6, 1:8, 1:10, 1:12 LVCMOS Clock Buffer Family
- Very Low Pin-to-Pin Skew < 50 ps
- Very Low Additive Jitter < 100 fs
- Supply Voltage: 3.3 V or 2.5 V
- $f_{max} = 250$  MHz for 3.3 V
- $f_{max} = 180$  MHz for 2.5 V

- Operating Temperature Range:  $-40^{\circ}\text{C}$  to  $85^{\circ}\text{C}$
- Available in 8-, 14-, 16-, 20-, 24-Pin TSSOP Package (all pin compatible)

### APPLICATIONS

- General Purpose Communication, Industrial and Consumer Applications

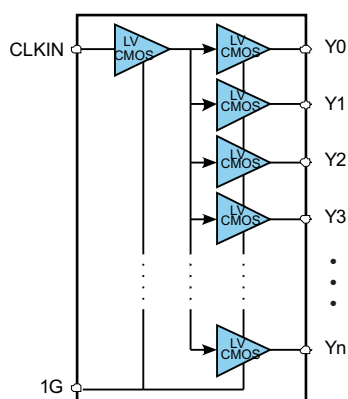

CLKIN	1		24	Y1
1G	2	CDCLVC 1102	23	Y3
Y0	3	CDCLVC 1103	22	VDD
GND	4	CDCLVC 1104	21	Y2
VDD	5		20	GND
Y4	6	CDCLVC 1106	19	Y5
GND	7		18	VDD
Y6	8	CDCLVC 1108	17	Y7
VDD	9		16	Y8
Y9	10	CDCLVC 1110	15	GND
GND	11		14	Y10
Y11	12	CDCLVC 1112	13	VDD

### DESCRIPTION

The CDCLVC11xx is a modular, high-performance, low-skew, general purpose clock buffer family from Texas Instruments.

The whole family is designed with a modular approach in mind. It is intended to round up TI's series of LVCMOS clock generators.

There are 7 different fan-out variations, 1:2 to 1:12, available. All of the devices are pin compatible to each other for easy handling.

All family members share the same high performing characteristics like low additive jitter, low skew, and wide operating temperature range.

The CDCLVC11xx supports an asynchronous output enable control (1G) which switches the outputs into a low state when 1G is low. Also, versions with synchronized enable control for glitch free switching and three-state outputs are planned in future device options.

The CDCLVC11xx operate in a 2.5 V and 3.3 V environment and are characterized for operation from  $-40^{\circ}\text{C}$  to  $85^{\circ}\text{C}$ .



Please be aware that an important notice concerning availability, standard warranty, and use in critical applications of Texas Instruments semiconductor products and disclaimers thereto appears at the end of this data sheet.



These devices have limited built-in ESD protection. The leads should be shorted together or the device placed in conductive foam during storage or handling to prevent electrostatic damage to the MOS gates.

**PACKAGE OPTIONS**

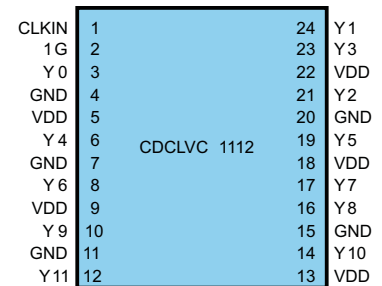
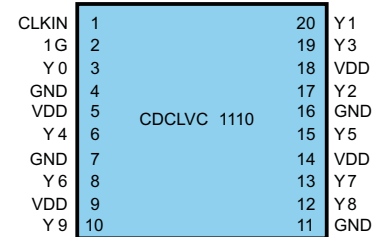
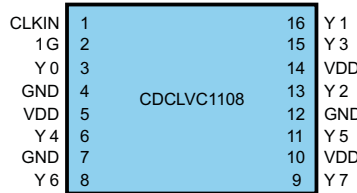
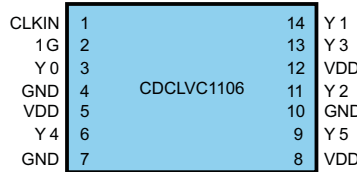
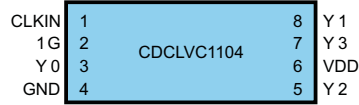
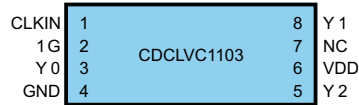
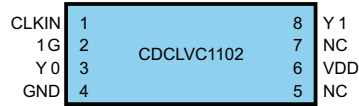

**PIN FUNCTIONS**

DEVICES	LVC MOS CLOCK INPUT	CLOCK OUTPUT ENABLE	LVC MOS CLOCK OUTPUT	SUPPLY VOLTAGE	GROUND
	CLKIN	1G	Y0, Y1, ... Y11	V <sub>DD</sub>	GND
CDCLVC1102	1	2	3, 8	6	4
CDCLVC1103	1	2	3, 8, 5	6	4
CDCLVC1104	1	2	3, 8, 5, 7	6	4
CDCLVC1106	1	2	3, 14, 11, 13, 6, 9	5, 8, 12	4, 7, 10
CDCLVC1108	1	2	3, 16, 13, 15, 6, 11, 8, 9	5, 10, 14	4, 7, 12
CDCLVC1110	1	2	3, 20, 17, 19, 6, 15, 8, 13, 10	5, 9, 14, 18	4, 7, 11, 16
CDCLVC1112	1	2	3, 24, 21, 23, 6, 19, 8, 17, 16, 10, 14, 12	5, 9, 13, 18, 22	4, 7, 11, 15, 20

**OUTPUT LOGIC TABLE**

INPUTS		OUTPUTS
CLKIN	1G	Y <sub>n</sub>
X	L	L
L	H	L
H	H	H

**ABSOLUTE MAXIMUM RATINGS<sup>(1)</sup>**

over operating free-air temperature range (unless otherwise noted)

		VALUE / UNIT
V <sub>DD</sub>	Supply voltage range	–0.5 V to 4.6 V
V <sub>IN</sub>	Input voltage range <sup>(2)</sup>	–0.5 V to V <sub>DD</sub> + 0.5 V
V <sub>O</sub>	Output voltage range <sup>(2)</sup>	–0.5 V to V <sub>DD</sub> + 0.5 V
I <sub>IN</sub>	Input current	±20 mA
I <sub>O</sub>	Continuous output current	±50 mA
T <sub>J</sub>	Maximum junction temperature	125°C
T <sub>ST</sub>	Storage temperature range	–65°C to 150°C

- (1) Stresses beyond those listed under "absolute maximum ratings" may cause permanent damage to the device. These are stress ratings only and functional operation of the device at these or any other conditions beyond those indicated under "recommended operating conditions" is not implied. Exposure to absolute-maximum-rated conditions for extended periods may affect device reliability.
- (2) This value is limited to 4.6 V maximum.

**THERMAL INFORMATION**

THERMAL METRIC <sup>(1)</sup>	DCDLVC1102/03/04	CDCLVC1106	CDCLVC1108	CDCLVC11010	CDCLVC1112	UNITS	
	PW	PW	PW	PW	PW		
	8 PINS	14 PINS	16 PINS	20 PINS	24 PINS		
θ <sub>JA</sub>	Junction-to-ambient thermal resistance <sup>(2)</sup>	149.4	112.6	108.4	83.0	87.9	°C/W
θ <sub>JC(top)</sub>	Junction-to-case(top) thermal resistance <sup>(3)</sup>	69.4	48.0	33.6	32.3	26.5	

- (1) For more information about traditional and new thermal metrics, see the *IC Package Thermal Metrics* application report, [SPRA953](#).
- (2) The junction-to-ambient thermal resistance under natural convection is obtained in a simulation on a JEDEC-standard, high-K board, as specified in JESD51-7, in an environment described in JESD51-2a.
- (3) The junction-to-case (top) thermal resistance is obtained by simulating a cold plate test on the package top. No specific JEDEC-standard test exists, but a close description can be found in the ANSI SEMI standard G30-88.

**RECOMMENDED OPERATING CONDITIONS**

over operating free-air temperature range (unless otherwise noted)

		MIN	NOM	MAX	UNIT	
V <sub>DD</sub>	Supply voltage range	3.3 V supply	3.0	3.3	3.6	V
		2.5 V supply	2.3	2.5	2.7	
V <sub>IL</sub>	Low-level input voltage	V <sub>DD</sub> = 3.0 V to 3.6 V			V <sub>DD</sub> /2 – 600	mV
		V <sub>DD</sub> = 2.3 V to 2.7 V			V <sub>DD</sub> /2 – 400	
V <sub>IH</sub>	High-level input voltage	V <sub>DD</sub> = 3.0 V to 3.6 V	V <sub>DD</sub> /2 + 600		mV	
		V <sub>DD</sub> = 2.3 V to 2.7 V	V <sub>DD</sub> /2 + 400			
V <sub>th</sub>	Input threshold voltage	V <sub>DD</sub> = 2.3 V to 3.6 V	V <sub>DD</sub> /2		mV	
t <sub>r</sub> / t <sub>f</sub>	Input slew rate		1		4	V/ns
t <sub>w</sub>	Minimum pulse width at CLKIN	V <sub>DD</sub> = 3.0 V to 3.6 V	1.8		ns	
		V <sub>DD</sub> = 2.3 V to 2.7 V	2.75			
f <sub>CLK</sub>	LVCMOS clock Input Frequency	V <sub>DD</sub> = 3.0 V to 3.6 V	DC		250	MHz
		V <sub>DD</sub> = 2.3 V to 2.7 V	DC		180	
T <sub>A</sub>	Operating free-air temperature		–40		85	°C

## DEVICE CHARACTERISTICS

over recommended operating free-air temperature range (unless otherwise noted)

PARAMETER		CONDITION	MIN	TYP <sup>(1)</sup>	MAX	UNIT
<b>OVERALL PARAMETERS FOR ALL VERSIONS</b>						
I <sub>DD</sub>	Static device current <sup>(2)</sup>	1G = V <sub>DD</sub> ; CLKIN = 0 V or V <sub>DD</sub> ; I <sub>O</sub> = 0 mA; V <sub>DD</sub> = 3.6 V	6	10		mA
		1G = V <sub>DD</sub> ; CLKIN = 0 V or V <sub>DD</sub> ; I <sub>O</sub> = 0 mA; V <sub>DD</sub> = 2.7 V	3	6		mA
I <sub>PD</sub>	Power down current	1G = 0 V; CLKIN = 0 V or V <sub>DD</sub> ; I <sub>O</sub> = 0 mA; V <sub>DD</sub> = 3.6 V or 2.7 V		60		μA
C <sub>PD</sub>	Power dissipation capacitance per output <sup>(3)</sup>	V <sub>DD</sub> = 3.3 V; f = 10 MHz	6			pF
		V <sub>DD</sub> = 2.5 V; f = 10 MHz	4.5			pF
I <sub>I</sub>	Input leakage current at 1G	V <sub>I</sub> = 0 V or V <sub>DD</sub> , V <sub>DD</sub> = 3.6 V or 2.7 V		± 8		μA
	Input leakage current at CLKIN			± 25		
R <sub>OUT</sub>	Output impedance	V <sub>DD</sub> = 3.3 V	45			Ω
		V <sub>DD</sub> = 2.5 V	60			Ω
f <sub>OUT</sub>	Output frequency	V <sub>DD</sub> = 3.0 V to 3.6 V	DC		250	MHz
		V <sub>DD</sub> = 2.3 V to 2.7 V	DC		180	MHz
<b>OUTPUT PARAMETERS FOR V<sub>DD</sub> = 3.3 V ± 0.3 V</b>						
V <sub>OH</sub>	High-level output voltage	V <sub>DD</sub> = 3 V, I <sub>OH</sub> = -0.1 mA	2.9			V
		V <sub>DD</sub> = 3 V, I <sub>OH</sub> = -8 mA	2.5			
		V <sub>DD</sub> = 3 V, I <sub>OH</sub> = -12 mA	2.2			
V <sub>OL</sub>	Low-level output voltage	V <sub>DD</sub> = 3 V, I <sub>OL</sub> = 0.1 mA			0.1	V
		V <sub>DD</sub> = 3 V, I <sub>OL</sub> = 8 mA			0.5	
		V <sub>DD</sub> = 3 V, I <sub>OL</sub> = 12 mA			0.8	
t <sub>PLH</sub> , t <sub>PHL</sub>	Propagation delay	CLKIN to Yn	0.8		2.0	ns
t <sub>sk(o)</sub>	Output skew	Equal load of each output			50	ps
t <sub>r</sub> /t <sub>f</sub>	Rise and fall time	20%–80% (V <sub>OH</sub> - V <sub>OL</sub> )	0.3		0.8	ns
t <sub>DIS</sub>	Output disable time	1G to Yn			6	ns
t <sub>EN</sub>	Output enable time	1G to Yn			6	ns
t <sub>sk(p)</sub>	Pulse skew ; t <sub>PLH(Yn)</sub> - t <sub>PHL(Yn)</sub> <sup>(4)</sup>	To be measured with input duty cycle of 50%			180	ps
t <sub>sk(pp)</sub>	Part-to-part skew	Under equal operating conditions for two parts			0.5	ns
t <sub>jitter</sub>	Additive jitter rms	12kHz...20 MHz, f <sub>OUT</sub> = 250 MHz			100	fs

(1) All typical values are at respective nominal V<sub>DD</sub>. For switching characteristics, outputs are terminated to 50 Ω to V<sub>DD</sub>/2 (see Figure 1).

(2) For dynamic I<sub>DD</sub> over frequency see Figure 8 and Figure 9.

(3) This is the formula for the power dissipation calculation (see Figure 8 and the Power Consideration section).

$$P_{tot} = P_{stat} + P_{dyn} + P_{Cload} [W]$$

$$P_{stat} = V_{DD} \times I_{DD} [W]$$

$$P_{dyn} = C_{PD} \times V_{DD}^2 \times f [W]$$

$$P_{Cload} = C_{load} \times V_{DD}^2 \times f \times n [W]$$

n = Number of switching output pins

(4) t<sub>sk(p)</sub> depends on output rise- and fall-time (t<sub>r</sub>/t<sub>f</sub>). The output duty-cycle can be calculated: odc = (t<sub>w(OUT)</sub> ± t<sub>sk(p)</sub>)/t<sub>period</sub>; t<sub>w(OUT)</sub> is pulse-width of output waveform and t<sub>period</sub> is 1/f<sub>OUT</sub>.

**DEVICE CHARACTERISTICS (continued)**

over recommended operating free-air temperature range (unless otherwise noted)

PARAMETER	CONDITION	MIN	TYP <sup>(1)</sup>	MAX	UNIT
<b>OUTPUT PARAMETERS FOR <math>V_{DD} = 2.5\text{ V} \pm 0.2\text{ V}</math></b>					
$V_{OH}$ High-level output voltage	$V_{DD} = 2.3\text{ V}, I_{OH} = -0.1\text{ mA}$	2.2			V
	$V_{DD} = 2.3\text{ V}, I_{OH} = -8\text{ mA}$	1.7			
$V_{OL}$ Low-level output voltage	$V_{DD} = 2.3\text{ V}, I_{OL} = 0.1\text{ mA}$			0.1	V
	$V_{DD} = 2.3\text{ V}, I_{OL} = 8\text{ mA}$			0.5	
$t_{PLH}$ , $t_{PHL}$ Propagation delay	CLKIN to Yn	1.0		2.6	ns
$t_{sk(o)}$ Output skew	Equal load of each output			50	ps
$t_r/t_f$ Rise and fall time	20%–80% reference point	0.3		1.2	ns
$t_{DIS}$ Output disable time	1G to Yn			10	ns
$t_{EN}$ Output enable time	1G to Yn			10	ns
$t_{sk(p)}$ Pulse skew ; $t_{PLH(Yn)} - t_{PHL(Yn)}$ <sup>(5)</sup>	To be measured with input duty cycle of 50%			220	ps
$t_{sk(pp)}$ Part-to-part skew	Under equal operating conditions for two parts			1.2	ns
$t_{jitter}$ Additive jitter rms	12kHz...20 MHz, $f_{OUT} = 180\text{ MHz}$			350	fs

(5)  $t_{sk(p)}$  depends on output rise- and fall-time ( $t_r/t_f$ ). The output duty-cycle can be calculated:  $odc = (t_{w(OUT)} \pm t_{sk(p)})/t_{period}$ ;  $t_{w(OUT)}$  is pulse-width of output waveform and  $t_{period}$  is  $1/f_{OUT}$ .

PARAMETERS MEASUREMENT INFORMATION

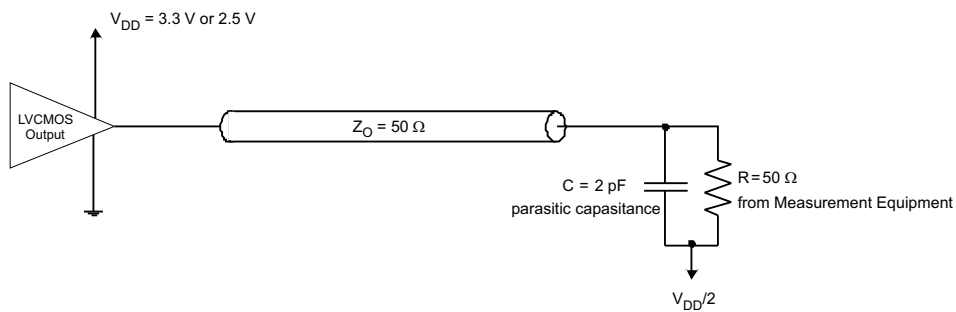

Figure 1. Test Load Circuit

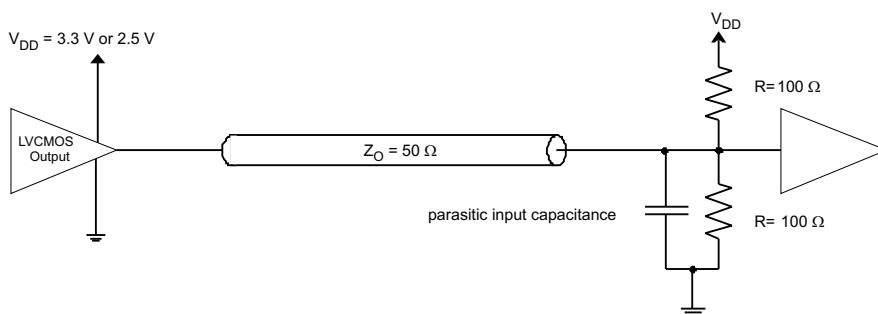

Figure 2. Application Load With 50 Ω Line Termination

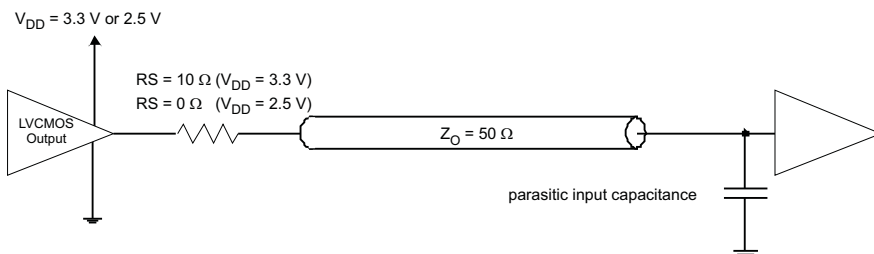

Figure 3. Application Load With Series Line Termination

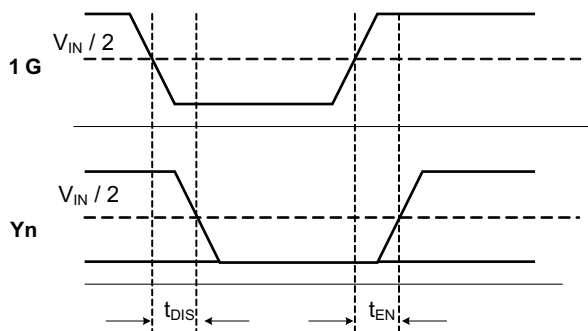

Figure 4.  $t_{DIS}$  and  $t_{EN}$  for Disable Low

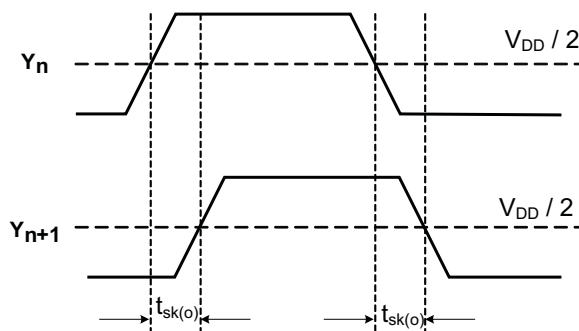
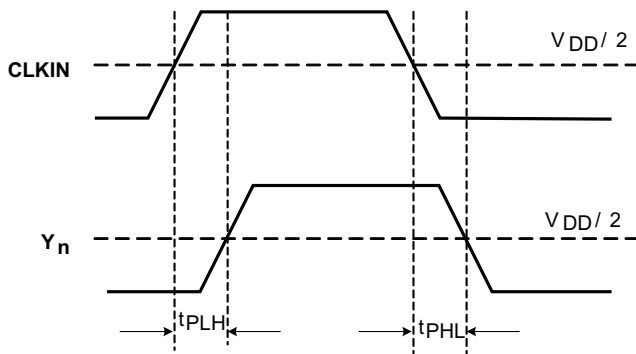

Figure 5. Output Skew  $t_{sk(o)}$

PARAMETERS MEASUREMENT INFORMATION (continued)



Note:  $t_{sk(p)} = |t_{PLH} - t_{PHL}|$

Figure 6. Pulse Skew  $t_{sk(p)}$  and Propagation Delay  $t_{PLH}/t_{PHL}$

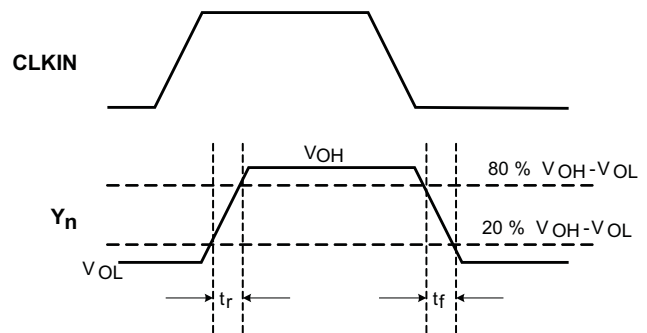

Figure 7. Rise/Fall Times  $t_r/t_f$

TYPICAL CHARACTERISTICS

Power Consideration

The following power consideration refers to the device-consumed power consumption only. The device power consumption is the sum of static power and dynamic power. The dynamic power usage consists of two components:

1. Power used by the device as it switches states.
2. Power required to charge any output load.

The output load can be capacitive only or capacitive and resistive. The following formula and the power graphs in Figure 8 and Figure 9 can be used to obtain the power consumption of the device:

$$P_{dev} = P_{stat} + n (P_{dyn} + P_{Cload})$$

$$P_{stat} = V_{DD} \times I_{DD}$$

$$P_{dyn} + P_{Cload} = \text{see Figure 8 and Figure 9}$$

where:

- $V_{DD}$  = Supply voltage (3.3 V or 2.5 V)
- $I_{DD}$  = Static device current (typ 6 mA for  $V_{DD} = 3.3$  V; typ 3 mA for  $V_{DD} = 2.5$  V)
- $n$  = Number of switching output pins

Example for Device Power Consumption for CDCLVC1104: 4 outputs are switching,  $f = 120$  MHz,  $V_{DD} = 3.3$  V and  $C_{load} = 2$  pF per output:

$$P_{dev} = P_{stat} + n (P_{dyn} + P_{Cload}) = 19.8 \text{ mW} + 40 \text{ mW} = 59.8 \text{ mW}$$

$$P_{stat} = V_{DD} \times I_{DD} = 6 \text{ mA} \times 3.3 \text{ V} = 19.8 \text{ mW}$$

$$n (P_{dyn} + P_{Cload}) = 4 \times 10 \text{ mW} = 40 \text{ mW}$$

NOTE

For dimensioning the power supply, the total power consumption needs to be considered. The total power consumption is the sum of the device power consumption and the power consumption of the load.

TYPICAL CHARACTERISTICS (continued)

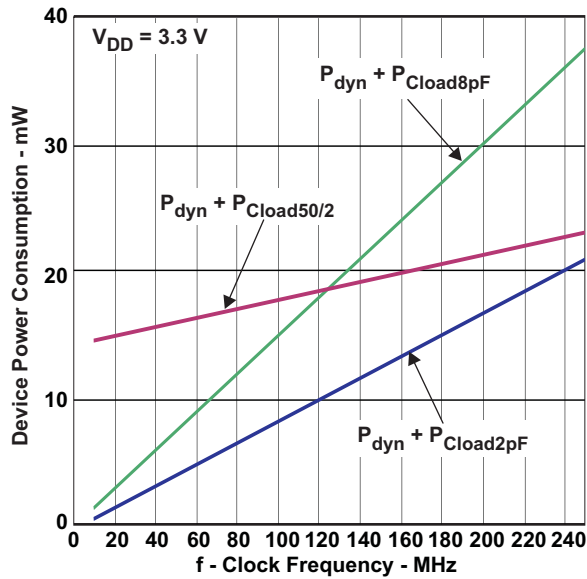

Figure 8. Device Power Consumption vs Clock Frequency (Load 50Ω into  $V_{DD}/2$ . 2pF, 8pF; Per Output)

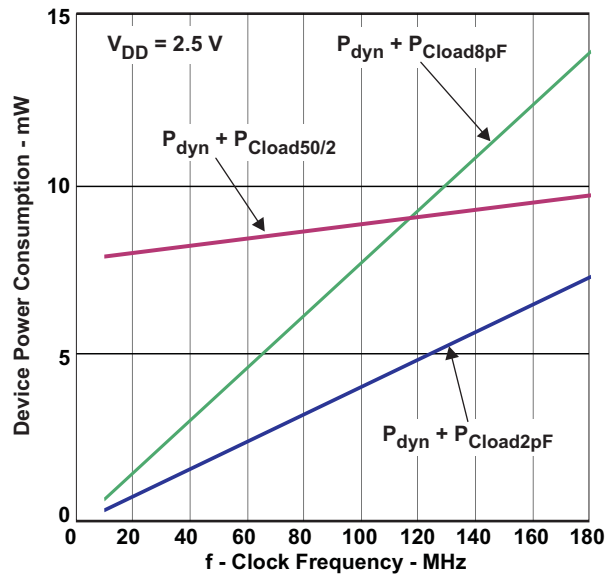

Figure 9. Device Power Consumption vs Clock Frequency (Load 50Ω into  $V_{DD}/2$ . 2pF, 8pF; Per Output)

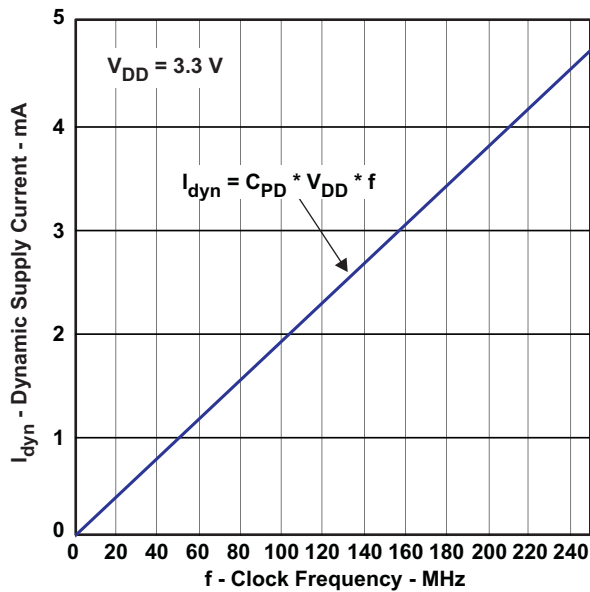

Figure 10. Dynamic Supply Current vs Clock Frequency ( $C_{PD} = 6pF$ , No Load; Per Output)

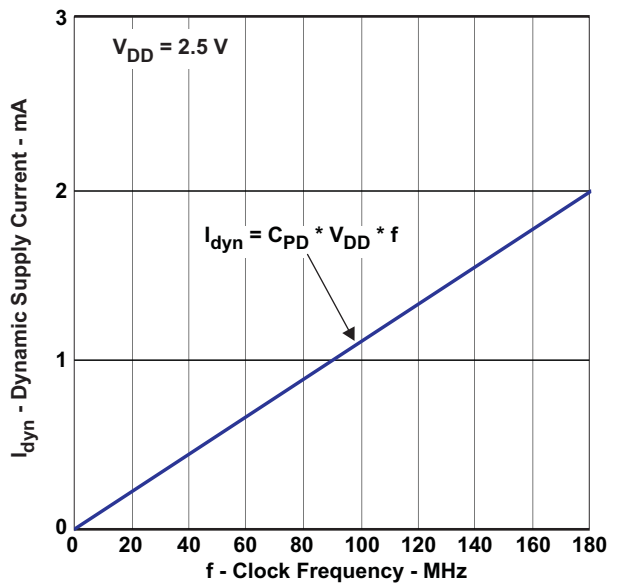

Figure 11. Dynamic Supply Current vs Clock Frequency ( $C_{PD} = 4.5pF$ , No Load; Per Output)



**PACKAGING INFORMATION**

Orderable Device	Status <sup>(1)</sup>	Package Type	Package Drawing	Pins	Package Qty	Eco Plan <sup>(2)</sup>	Lead/ Ball Finish	MSL Peak Temp <sup>(3)</sup>	Samples (Requires Login)
CDCLVC1102PW	ACTIVE	TSSOP	PW	8	150	Green (RoHS & no Sb/Br)	CU NIPDAU	Level-1-260C-UNLIM	<a href="#">Purchase Samples</a>
CDCLVC1102PWR	ACTIVE	TSSOP	PW	8	2000	Green (RoHS & no Sb/Br)	CU NIPDAU	Level-1-260C-UNLIM	<a href="#">Purchase Samples</a>
CDCLVC1103PW	ACTIVE	TSSOP	PW	8	150	Green (RoHS & no Sb/Br)	CU NIPDAU	Level-1-260C-UNLIM	<a href="#">Purchase Samples</a>
CDCLVC1103PWR	ACTIVE	TSSOP	PW	8	2000	Green (RoHS & no Sb/Br)	CU NIPDAU	Level-1-260C-UNLIM	<a href="#">Request Free Samples</a>
CDCLVC1104PW	ACTIVE	TSSOP	PW	8	150	Green (RoHS & no Sb/Br)	CU NIPDAU	Level-1-260C-UNLIM	<a href="#">Purchase Samples</a>
CDCLVC1104PWR	ACTIVE	TSSOP	PW	8	2000	Green (RoHS & no Sb/Br)	CU NIPDAU	Level-1-260C-UNLIM	<a href="#">Request Free Samples</a>
CDCLVC1106PW	ACTIVE	TSSOP	PW	14	90	Green (RoHS & no Sb/Br)	CU NIPDAU	Level-1-260C-UNLIM	<a href="#">Purchase Samples</a>
CDCLVC1106PWR	ACTIVE	TSSOP	PW	14	2000	Green (RoHS & no Sb/Br)	CU NIPDAU	Level-1-260C-UNLIM	<a href="#">Request Free Samples</a>
CDCLVC1108PW	ACTIVE	TSSOP	PW	16	90	Green (RoHS & no Sb/Br)	CU NIPDAU	Level-1-260C-UNLIM	<a href="#">Purchase Samples</a>
CDCLVC1108PWR	ACTIVE	TSSOP	PW	16	2000	Green (RoHS & no Sb/Br)	CU NIPDAU	Level-1-260C-UNLIM	<a href="#">Request Free Samples</a>
CDCLVC1110PW	ACTIVE	TSSOP	PW	20	70	Green (RoHS & no Sb/Br)	CU NIPDAU	Level-1-260C-UNLIM	<a href="#">Purchase Samples</a>
CDCLVC1110PWR	ACTIVE	TSSOP	PW	20	2000	Green (RoHS & no Sb/Br)	CU NIPDAU	Level-1-260C-UNLIM	<a href="#">Request Free Samples</a>
CDCLVC1112PW	ACTIVE	TSSOP	PW	24	60	Green (RoHS & no Sb/Br)	CU NIPDAU	Level-1-260C-UNLIM	<a href="#">Purchase Samples</a>
CDCLVC1112PWR	ACTIVE	TSSOP	PW	24	2000	Green (RoHS & no Sb/Br)	CU NIPDAU	Level-1-260C-UNLIM	<a href="#">Request Free Samples</a>

<sup>(1)</sup> The marketing status values are defined as follows:

**ACTIVE:** Product device recommended for new designs.

**LIFEBUY:** TI has announced that the device will be discontinued, and a lifetime-buy period is in effect.

**NRND:** Not recommended for new designs. Device is in production to support existing customers, but TI does not recommend using this part in a new design.

**PREVIEW:** Device has been announced but is not in production. Samples may or may not be available.

**OBSELETE:** TI has discontinued the production of the device.

<sup>(2)</sup> Eco Plan - The planned eco-friendly classification: Pb-Free (RoHS), Pb-Free (RoHS Exempt), or Green (RoHS & no Sb/Br) - please check <http://www.ti.com/productcontent> for the latest availability information and additional product content details.

**TBD:** The Pb-Free/Green conversion plan has not been defined.

**Pb-Free (RoHS):** TI's terms "Lead-Free" or "Pb-Free" mean semiconductor products that are compatible with the current RoHS requirements for all 6 substances, including the requirement that lead not exceed 0.1% by weight in homogeneous materials. Where designed to be soldered at high temperatures, TI Pb-Free products are suitable for use in specified lead-free processes.

**Pb-Free (RoHS Exempt):** This component has a RoHS exemption for either 1) lead-based flip-chip solder bumps used between the die and package, or 2) lead-based die adhesive used between the die and leadframe. The component is otherwise considered Pb-Free (RoHS compatible) as defined above.

**Green (RoHS & no Sb/Br):** TI defines "Green" to mean Pb-Free (RoHS compatible), and free of Bromine (Br) and Antimony (Sb) based flame retardants (Br or Sb do not exceed 0.1% by weight in homogeneous material)

<sup>(3)</sup> MSL, Peak Temp. -- The Moisture Sensitivity Level rating according to the JEDEC industry standard classifications, and peak solder temperature.

**Important Information and Disclaimer:** The information provided on this page represents TI's knowledge and belief as of the date that it is provided. TI bases its knowledge and belief on information provided by third parties, and makes no representation or warranty as to the accuracy of such information. Efforts are underway to better integrate information from third parties. TI has taken and continues to take reasonable steps to provide representative and accurate information but may not have conducted destructive testing or chemical analysis on incoming materials and chemicals. TI and TI suppliers consider certain information to be proprietary, and thus CAS numbers and other limited information may not be available for release.

In no event shall TI's liability arising out of such information exceed the total purchase price of the TI part(s) at issue in this document sold by TI to Customer on an annual basis.

**TAPE AND REEL INFORMATION**

**QUADRANT ASSIGNMENTS FOR PIN 1 ORIENTATION IN TAPE**

\*All dimensions are nominal

Device	Package Type	Package Drawing	Pins	SPQ	Reel Diameter (mm)	Reel Width W1 (mm)	A0 (mm)	B0 (mm)	K0 (mm)	P1 (mm)	W (mm)	Pin1 Quadrant
CDCLVC1102PWR	TSSOP	PW	8	2000	330.0	12.4	7.0	3.6	1.6	8.0	12.0	Q1
CDCLVC1103PWR	TSSOP	PW	8	2000	330.0	12.4	7.0	3.6	1.6	8.0	12.0	Q1
CDCLVC1104PWR	TSSOP	PW	8	2000	330.0	12.4	7.0	3.6	1.6	8.0	12.0	Q1
CDCLVC1106PWR	TSSOP	PW	14	2000	330.0	12.4	6.9	5.6	1.6	8.0	12.0	Q1
CDCLVC1108PWR	TSSOP	PW	16	2000	330.0	12.4	6.9	5.6	1.6	8.0	12.0	Q1
CDCLVC1110PWR	TSSOP	PW	20	2000	330.0	16.4	6.95	7.1	1.6	8.0	16.0	Q1
CDCLVC1112PWR	TSSOP	PW	24	2000	330.0	16.4	6.95	8.3	1.6	8.0	16.0	Q1

**TAPE AND REEL BOX DIMENSIONS**

\*All dimensions are nominal

Device	Package Type	Package Drawing	Pins	SPQ	Length (mm)	Width (mm)	Height (mm)
CDCLVC1102PWR	TSSOP	PW	8	2000	346.0	346.0	29.0
CDCLVC1103PWR	TSSOP	PW	8	2000	346.0	346.0	29.0
CDCLVC1104PWR	TSSOP	PW	8	2000	346.0	346.0	29.0
CDCLVC1106PWR	TSSOP	PW	14	2000	346.0	346.0	29.0
CDCLVC1108PWR	TSSOP	PW	16	2000	346.0	346.0	29.0
CDCLVC1110PWR	TSSOP	PW	20	2000	346.0	346.0	33.0
CDCLVC1112PWR	TSSOP	PW	24	2000	346.0	346.0	33.0

PW (R-PDSO-G14)

PLASTIC SMALL OUTLINE



- NOTES:
- A. All linear dimensions are in millimeters. Dimensioning and tolerancing per ASME Y14.5M-1994.
  - B. This drawing is subject to change without notice.
  -  Body length does not include mold flash, protrusions, or gate burrs. Mold flash, protrusions, or gate burrs shall not exceed 0,15 each side.
  -  Body width does not include interlead flash. Interlead flash shall not exceed 0,25 each side.
  - E. Falls within JEDEC MO-153

PW (R-PDSO-G14)

PLASTIC SMALL OUTLINE



- NOTES:
- All linear dimensions are in millimeters.
  - This drawing is subject to change without notice.
  - Publication IPC-7351 is recommended for alternate designs.
  - Laser cutting apertures with trapezoidal walls and also rounding corners will offer better paste release. Customers should contact their board assembly site for stencil design recommendations. Refer to IPC-7525 for other stencil recommendations.
  - Customers should contact their board fabrication site for solder mask tolerances between and around signal pads.

PW (R-PDSO-G16)

PLASTIC SMALL OUTLINE



4040064-4/G 02/11

- NOTES:
- A. All linear dimensions are in millimeters. Dimensioning and tolerancing per ASME Y14.5M-1994.
  - B. This drawing is subject to change without notice.
  -  Body length does not include mold flash, protrusions, or gate burrs. Mold flash, protrusions, or gate burrs shall not exceed 0,15 each side.
  -  Body width does not include interlead flash. Interlead flash shall not exceed 0,25 each side.
  - E. Falls within JEDEC MO-153

PW (R-PDSO-G16)

PLASTIC SMALL OUTLINE

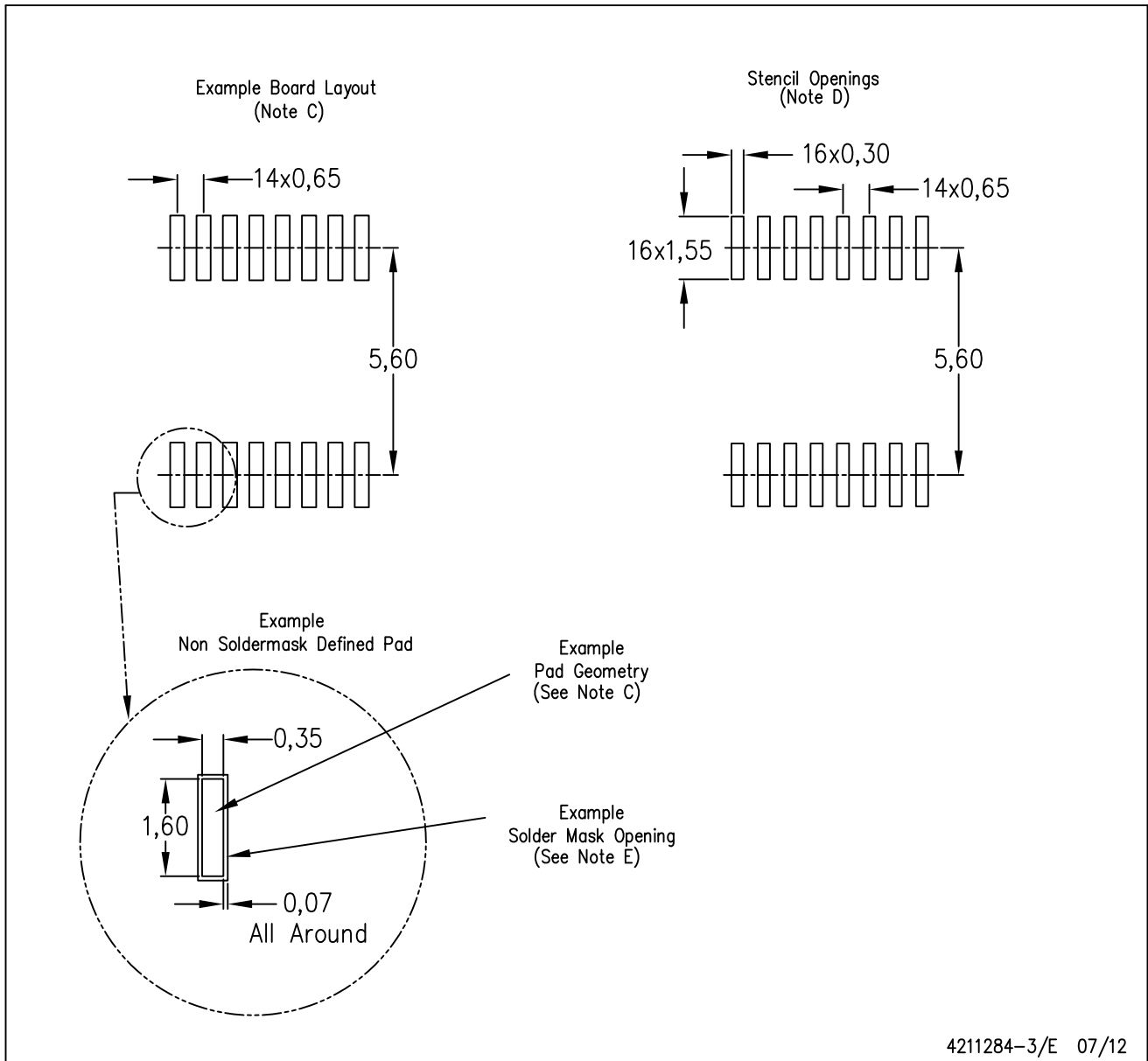

4211284-3/E 07/12

- NOTES:
- All linear dimensions are in millimeters.
  - This drawing is subject to change without notice.
  - Publication IPC-7351 is recommended for alternate designs.
  - Laser cutting apertures with trapezoidal walls and also rounding corners will offer better paste release. Customers should contact their board assembly site for stencil design recommendations. Refer to IPC-7525 for other stencil recommendations.
  - Customers should contact their board fabrication site for solder mask tolerances between and around signal pads.



PW (R-PDSO-G20)

PLASTIC SMALL OUTLINE



4040064-5/G 02/11

- NOTES:
- A. All linear dimensions are in millimeters. Dimensioning and tolerancing per ASME Y14.5M-1994.
  - B. This drawing is subject to change without notice.
  - C. Body length does not include mold flash, protrusions, or gate burrs. Mold flash, protrusions, or gate burrs shall not exceed 0,15 each side.
  - D. Body width does not include interlead flash. Interlead flash shall not exceed 0,25 each side.
  - E. Falls within JEDEC MO-153

PW (R-PDSO-G20)

PLASTIC SMALL OUTLINE



- NOTES:
- A. All linear dimensions are in millimeters.
  - B. This drawing is subject to change without notice.
  - C. Publication IPC-7351 is recommended for alternate design.
  - D. Laser cutting apertures with trapezoidal walls and also rounding corners will offer better paste release. Customers should contact their board assembly site for stencil design recommendations. Refer to IPC-7525 for other stencil recommendations.
  - E. Customers should contact their board fabrication site for solder mask tolerances between and around signal pads.

PW (R-PDSO-G24)

PLASTIC SMALL OUTLINE

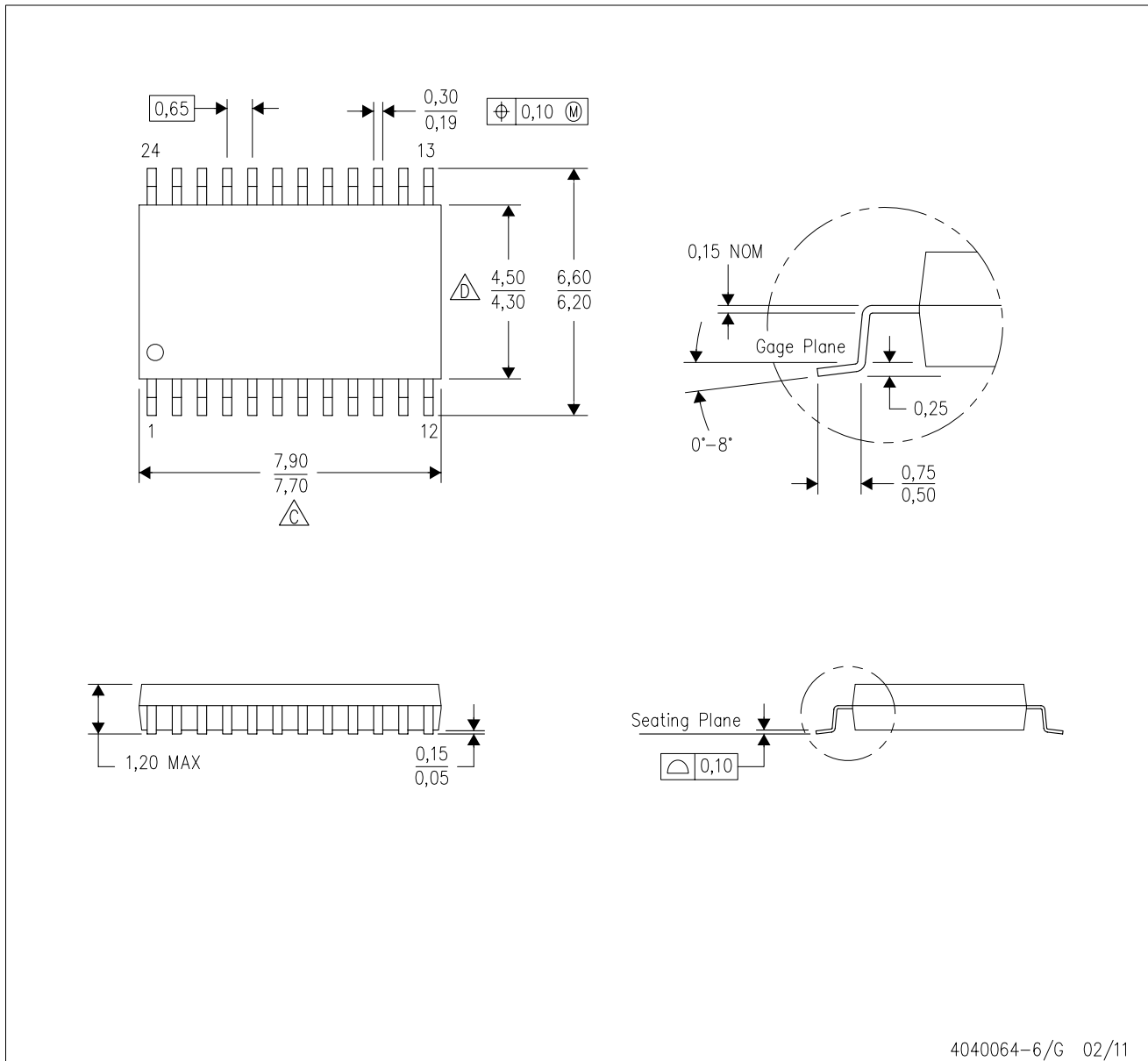

4040064-6/G 02/11

- NOTES:
- A. All linear dimensions are in millimeters. Dimensioning and tolerancing per ASME Y14.5M-1994.
  - B. This drawing is subject to change without notice.
  -  C. Body length does not include mold flash, protrusions, or gate burrs. Mold flash, protrusions, or gate burrs shall not exceed 0,15 each side.
  -  D. Body width does not include interlead flash. Interlead flash shall not exceed 0,25 each side.
  - E. Falls within JEDEC MO-153

PW (R-PDSO-G24)

PLASTIC SMALL OUTLINE

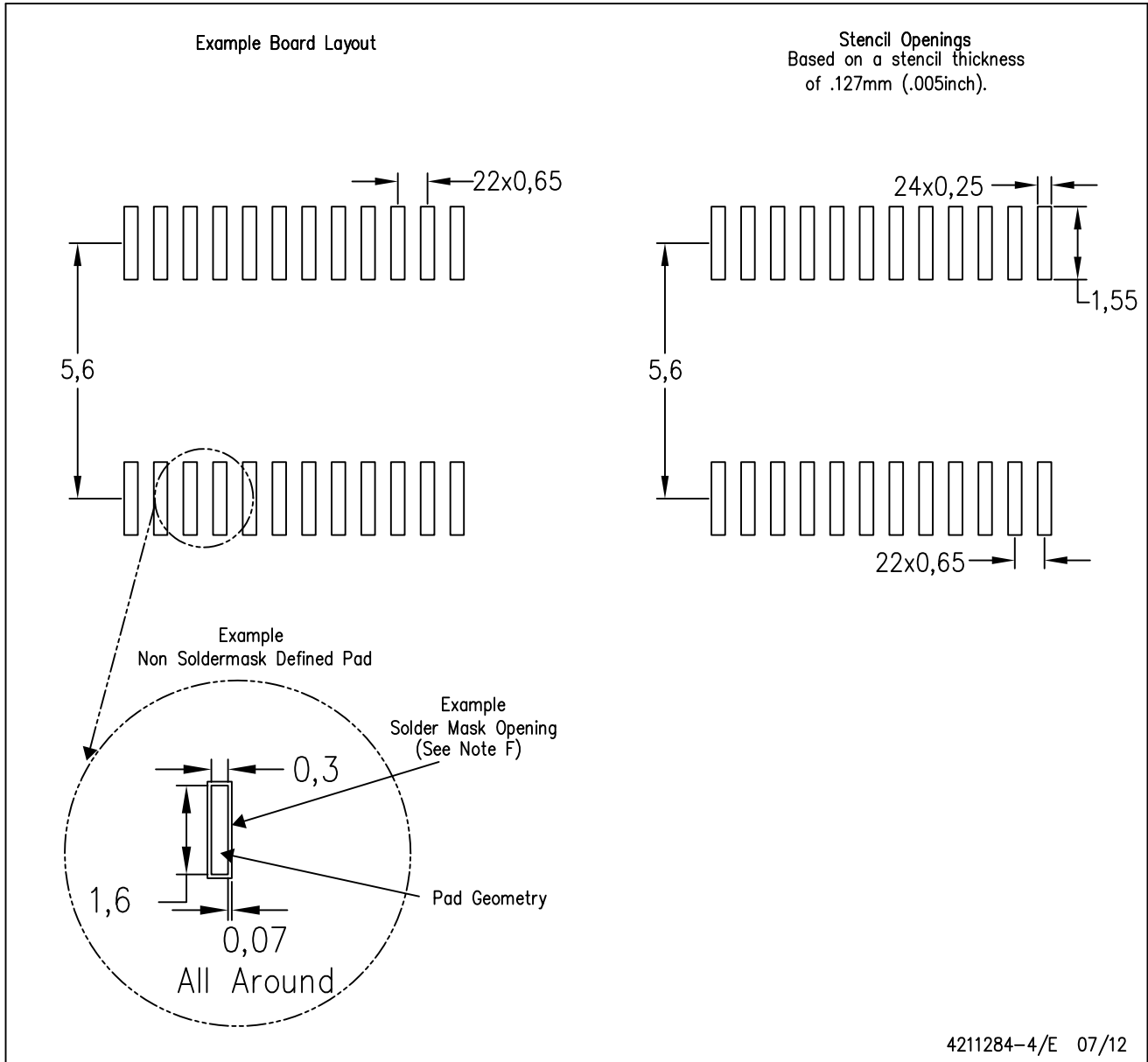

- NOTES:
- All linear dimensions are in millimeters.
  - This drawing is subject to change without notice.
  - Publication IPC-7351 is recommended for alternate design.
  - Laser cutting apertures with trapezoidal walls and also rounding corners will offer better paste release. Customers should contact their board assembly site for stencil design recommendations. Refer to IPC-7525 for other stencil recommendations.
  - Customers should contact their board fabrication site for solder mask tolerances between and around signal pads.

PW (R-PDSO-G28)

PLASTIC SMALL OUTLINE



4040064-7/G 02/11

- NOTES:
- A. All linear dimensions are in millimeters. Dimensioning and tolerancing per ASME Y14.5M-1994.
  - B. This drawing is subject to change without notice.
  - C. Body length does not include mold flash, protrusions, or gate burrs. Mold flash, protrusions, or gate burrs shall not exceed 0,15 each side.
  - D. Body width does not include interlead flash. Interlead flash shall not exceed 0,25 each side.
  - E. Falls within JEDEC MO-153

PW (R-PDSO-G8)

PLASTIC SMALL OUTLINE

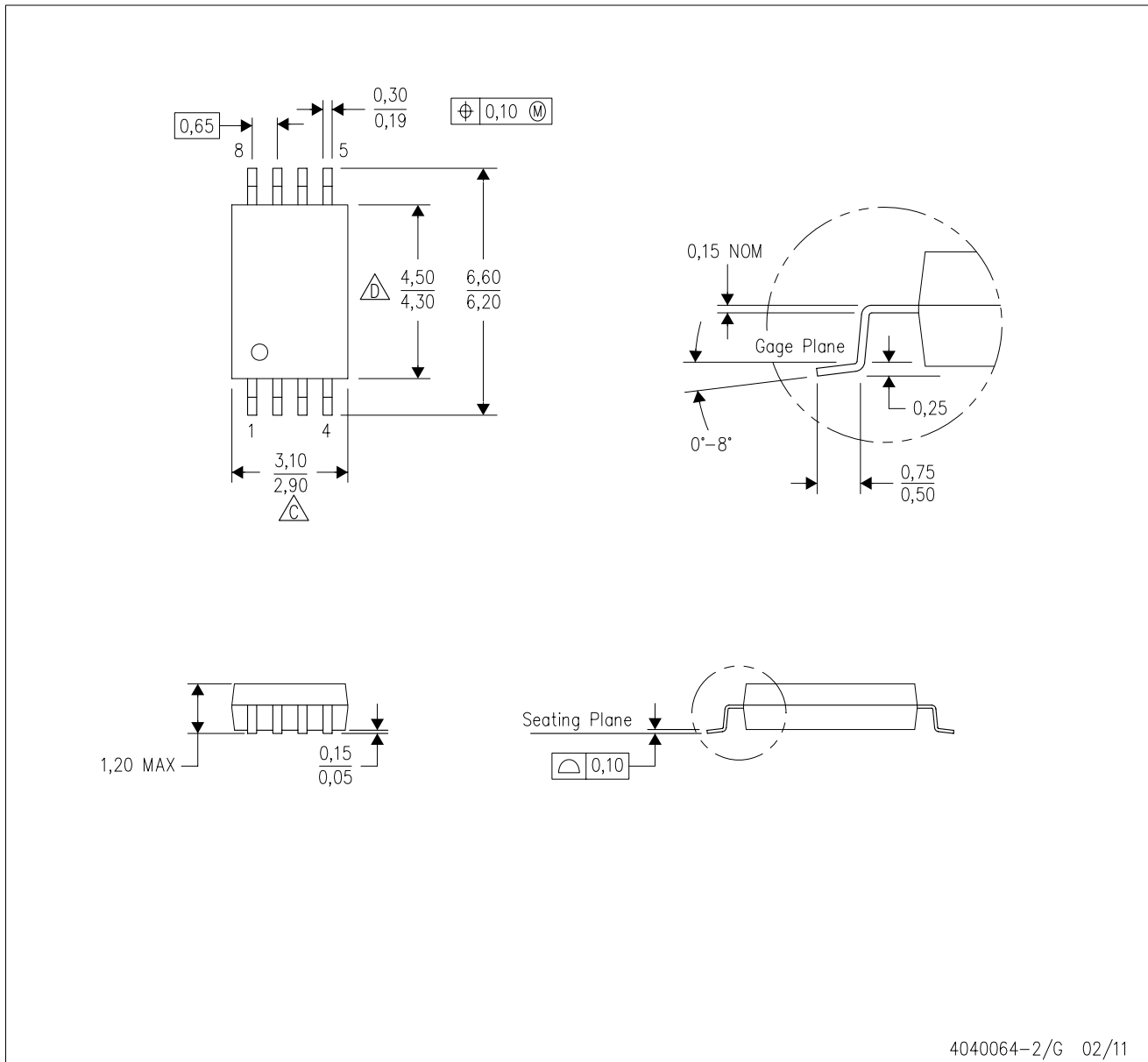

- NOTES:
- A. All linear dimensions are in millimeters. Dimensioning and tolerancing per ASME Y14.5M-1994.
  - B. This drawing is subject to change without notice.
  - C. Body length does not include mold flash, protrusions, or gate burrs. Mold flash, protrusions, or gate burrs shall not exceed 0,15 each side.
  - D. Body width does not include interlead flash. Interlead flash shall not exceed 0,25 each side.
  - E. Falls within JEDEC MO-153

## IMPORTANT NOTICE

Texas Instruments Incorporated and its subsidiaries (TI) reserve the right to make corrections, modifications, enhancements, improvements, and other changes to its products and services at any time and to discontinue any product or service without notice. Customers should obtain the latest relevant information before placing orders and should verify that such information is current and complete. All products are sold subject to TI's terms and conditions of sale supplied at the time of order acknowledgment.

TI warrants performance of its hardware products to the specifications applicable at the time of sale in accordance with TI's standard warranty. Testing and other quality control techniques are used to the extent TI deems necessary to support this warranty. Except where mandated by government requirements, testing of all parameters of each product is not necessarily performed.

TI assumes no liability for applications assistance or customer product design. Customers are responsible for their products and applications using TI components. To minimize the risks associated with customer products and applications, customers should provide adequate design and operating safeguards.

TI does not warrant or represent that any license, either express or implied, is granted under any TI patent right, copyright, mask work right, or other TI intellectual property right relating to any combination, machine, or process in which TI products or services are used. Information published by TI regarding third-party products or services does not constitute a license from TI to use such products or services or a warranty or endorsement thereof. Use of such information may require a license from a third party under the patents or other intellectual property of the third party, or a license from TI under the patents or other intellectual property of TI.

Reproduction of TI information in TI data books or data sheets is permissible only if reproduction is without alteration and is accompanied by all associated warranties, conditions, limitations, and notices. Reproduction of this information with alteration is an unfair and deceptive business practice. TI is not responsible or liable for such altered documentation. Information of third parties may be subject to additional restrictions.

Resale of TI products or services with statements different from or beyond the parameters stated by TI for that product or service voids all express and any implied warranties for the associated TI product or service and is an unfair and deceptive business practice. TI is not responsible or liable for any such statements.

TI products are not authorized for use in safety-critical applications (such as life support) where a failure of the TI product would reasonably be expected to cause severe personal injury or death, unless officers of the parties have executed an agreement specifically governing such use. Buyers represent that they have all necessary expertise in the safety and regulatory ramifications of their applications, and acknowledge and agree that they are solely responsible for all legal, regulatory and safety-related requirements concerning their products and any use of TI products in such safety-critical applications, notwithstanding any applications-related information or support that may be provided by TI. Further, Buyers must fully indemnify TI and its representatives against any damages arising out of the use of TI products in such safety-critical applications.

TI products are neither designed nor intended for use in military/aerospace applications or environments unless the TI products are specifically designated by TI as military-grade or "enhanced plastic." Only products designated by TI as military-grade meet military specifications. Buyers acknowledge and agree that any such use of TI products which TI has not designated as military-grade is solely at the Buyer's risk, and that they are solely responsible for compliance with all legal and regulatory requirements in connection with such use.

TI products are neither designed nor intended for use in automotive applications or environments unless the specific TI products are designated by TI as compliant with ISO/TS 16949 requirements. Buyers acknowledge and agree that, if they use any non-designated products in automotive applications, TI will not be responsible for any failure to meet such requirements.

Following are URLs where you can obtain information on other Texas Instruments products and application solutions:

### Products

Audio	<a href="http://www.ti.com/audio">www.ti.com/audio</a>
Amplifiers	<a href="http://amplifier.ti.com">amplifier.ti.com</a>
Data Converters	<a href="http://dataconverter.ti.com">dataconverter.ti.com</a>
DLP® Products	<a href="http://www.dlp.com">www.dlp.com</a>
DSP	<a href="http://dsp.ti.com">dsp.ti.com</a>
Clocks and Timers	<a href="http://www.ti.com/clocks">www.ti.com/clocks</a>
Interface	<a href="http://interface.ti.com">interface.ti.com</a>
Logic	<a href="http://logic.ti.com">logic.ti.com</a>
Power Mgmt	<a href="http://power.ti.com">power.ti.com</a>
Microcontrollers	<a href="http://microcontroller.ti.com">microcontroller.ti.com</a>
RFID	<a href="http://www.ti-rfid.com">www.ti-rfid.com</a>
OMAP Mobile Processors	<a href="http://www.ti.com/omap">www.ti.com/omap</a>
Wireless Connectivity	<a href="http://www.ti.com/wirelessconnectivity">www.ti.com/wirelessconnectivity</a>

### Applications

Automotive and Transportation	<a href="http://www.ti.com/automotive">www.ti.com/automotive</a>
Communications and Telecom	<a href="http://www.ti.com/communications">www.ti.com/communications</a>
Computers and Peripherals	<a href="http://www.ti.com/computers">www.ti.com/computers</a>
Consumer Electronics	<a href="http://www.ti.com/consumer-apps">www.ti.com/consumer-apps</a>
Energy and Lighting	<a href="http://www.ti.com/energy">www.ti.com/energy</a>
Industrial	<a href="http://www.ti.com/industrial">www.ti.com/industrial</a>
Medical	<a href="http://www.ti.com/medical">www.ti.com/medical</a>
Security	<a href="http://www.ti.com/security">www.ti.com/security</a>
Space, Avionics and Defense	<a href="http://www.ti.com/space-avionics-defense">www.ti.com/space-avionics-defense</a>
Video and Imaging	<a href="http://www.ti.com/video">www.ti.com/video</a>

TI E2E Community Home Page

[e2e.ti.com](http://e2e.ti.com)

Mailing Address: Texas Instruments, Post Office Box 655303, Dallas, Texas 75265  
Copyright © 2012, Texas Instruments Incorporated