

Current-compensated Chokes



- | Rated currents from 0.3 to 10 A
- | DC to 1kHz frequency
- | 100kHz to 3MHz common-mode resonance frequency
- | Dual-choke configurations
- | Multiple PCB-mounting options



Performance indicators

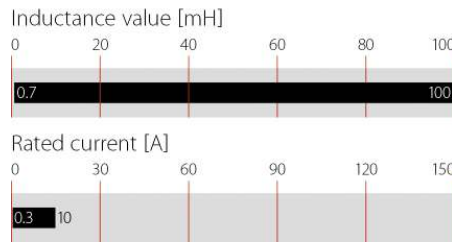

Technical specifications

| | |
|--|--|
| Flammability corresponding to High potential test voltage | UL 94 V-0 |
| winding-to-housing @ 25°C | 4000 VAC, 60 sec, guaranteed |
| winding-to-winding @ 25°C | 1500 VAC, 60 sec, guaranteed 1500 V, 50 Hz, 2 sec, factory test |
| Maximum continuous operating voltage | 250 VAC |
| MTBF @ 40°C/230V (Mil-HB-217F) | > 5,000,000 hours |
| Operating frequency | 50/60 Hz |
| Rated currents | 0.3 to 10 A @ 40 °C max. |
| Surge current @ 10msec | 20 x Inominal @ 25°C |
| Temperature range (operation and storage) | -40 °C to +125 °C (40/125/56) |

Approvals



VDE: excluding RN 102, RN 202

RN chokes are attenuating common-mode or asymmetric (P/N -> E) interference signals, by being connected in series with the phase and neutral lines of an AC powerline input. Symmetrical components of the noise are also attenuated by the leakage inductance of the windings. These chokes are typically used in conjunction with suppression capacitors.

Features and benefits

- | High saturation resistance and excellent thermal behavior
- | Through hole pin connections
- | Dual-choke configuration
- | Small compact design
- | Multiple housing options
- | Custom-specific versions are available on request

Typical applications

- | Phase-angle control circuits in combination with saturating chokes
- | EMI input filters
- | For suppressing equipment with no earth connection
- | Suppressing high interference levels

Typical electrical schematic



Choke selection table

| Choke* | Nominal current @ 40 °C | Inductance L | Resistance R | Choke configuration | Input/Output connections | Type 1 | Weight Type 2 |
|---------------|----------------------------|-----------------|-----------------|------------------------|-----------------------------|--------|------------------|
| | | | | | | | |
| RN x02-0.3-02 | 0.3 | 12 | 1275 | 2 | -02 | 2 | 3 |
| RN x02-0.6-02 | 0.6 | 4.4 | 385 | 2 | -02 | 2 | 3 |
| RN x02-1-02 | 1 | 3 | 205 | 2 | -02 | 2 | 3 |
| RN x02-1.5-02 | 1.5 | 1.6 | 100 | 2 | -02 | 2 | 3 |
| RN x02-2-02 | 2 | 1.1 | 70 | 2 | -02 | 2 | 3 |
| RN x12-0.4-02 | 0.4 | 39 | 1460 | 2 | -02 | 5 | 6 |
| RN x12-0.5-02 | 0.5 | 27 | 1250 | 2 | -02 | 5 | 6 |
| RN x12-0.6-02 | 0.6 | 15 | 465 | 2 | -02 | 5 | 6 |
| RN x12-0.8-02 | 0.8 | 10 | 370 | 2 | -02 | 5 | 6 |
| RN x12-1.2-02 | 1.2 | 6.8 | 245 | 2 | -02 | 5 | 6 |
| RN x12-1.5-02 | 1.5 | 3.3 | 135 | 2 | -02 | 5 | 6 |
| RN x12-2-02 | 2 | 1.8 | 75 | 2 | -02 | 5 | 6 |
| RN x12-4-02 | 4 | 0.7 | 27 | 2 | -02 | 5 | 6 |
| RN x14-0.3-02 | 0.3 | 47 | 1750 | 2 | -02 | 9 | 12 |
| RN x14-0.5-02 | 0.5 | 39 | 810 | 2 | -02 | 9 | 12 |
| RN x14-0.8-02 | 0.8 | 27 | 500 | 2 | -02 | 9 | 12 |
| RN x14-1-02 | 1 | 15 | 375 | 2 | -02 | 9 | 12 |
| RN x14-1.2-02 | 1.2 | 10 | 200 | 2 | -02 | 9 | 12 |
| RN x14-1.5-02 | 1.5 | 6.8 | 130 | 2 | -02 | 9 | 12 |
| RN x14-2-02 | 2 | 4.2 | 102 | 2 | -02 | 9 | 12 |
| RN x14-2.5-02 | 2.5 | 3.3 | 72 | 2 | -02 | 9 | 12 |
| RN x14-3-02 | 3 | 2 | 55 | 2 | -02 | 9 | 12 |
| RN x14-4-02 | 4 | 1.5 | 35 | 2 | -02 | 9 | 12 |
| RN x22-0.6-02 | 0.6 | 47 | 1180 | 2 | -02 | 17 | 21 |
| RN x22-0.8-02 | 0.8 | 39 | 1000 | 2 | -02 | 17 | 21 |
| RN x22-1-02 | 1 | 18 | 610 | 2 | -02 | 17 | 21 |
| RN x22-1.5-02 | 1.5 | 10 | 220 | 2 | -02 | 17 | 21 |
| RN x22-2-02 | 2 | 6.8 | 147 | 2 | -02 | 17 | 21 |
| RN x22-2.5-02 | 2.5 | 5.6 | 105 | 2 | -02 | 17 | 21 |
| RN x22-3-02 | 3 | 4.5 | 80 | 2 | -02 | 17 | 21 |
| RN x22-4-02 | 4 | 3.3 | 45 | 2 | -02 | 17 | 21 |
| RN x42-0.5-02 | 0.5 | 82 | 2700 | 2 | -02 | 32 | 32 |
| RN x42-1-02 | 1 | 33 | 810 | 2 | -02 | 32 | 32 |
| RN x42-1.4-02 | 1.4 | 27 | 500 | 2 | -02 | 32 | 32 |
| RN x42-2-02 | 2 | 6.8 | 190 | 2 | -02 | 32 | 32 |
| RN x42-4-02 | 4 | 3.3 | 66 | 2 | -02 | 32 | 32 |
| RN x42-6-02 | 6 | 1.8 | 20 | 2 | -02 | 32 | 32 |

Choke selection table

| Choke* | Nominal current @ 40 °C | Inductance L | Resistance R | Choke configuration | Input/Output connections | Type 1 [g] | Weight Type 2 [g] |
|----------------------|----------------------------|-----------------|-----------------|------------------------|---|---------------|-------------------------|
| | [A] | [mH/path] | [mΩ/path] | [Qty] |  | | |
| RN 143-0.5-02 | 0.5 | 100 | 2900 | 2 | -02 | 33 | |
| RN 143-1-02 | 1 | 47 | 880 | 2 | -02 | 33 | |
| RN 143-2-02 | 2 | 10 | 230 | 2 | -02 | 33 | |
| RN 143-4-02 | 4 | 3.9 | 58 | 2 | -02 | 33 | |
| RN 143-6-02 | 6 | 1.8 | 20 | 2 | -02 | 33 | |
| RN 152-1-02 | 1 | 68 | 1300 | 2 | -02 | 54 | |
| RN 152-2-02 | 2 | 18 | 350 | 2 | -02 | 54 | |
| RN 152-4-02 | 4 | 6.8 | 87 | 2 | -02 | 54 | |
| RN 152-6-02 | 6 | 3.9 | 41 | 2 | -02 | 54 | |
| RN 152-8-02 | 8 | 2.7 | 22 | 2 | -02 | 54 | |
| RN 152-10-02 | 10 | 1.8 | 14 | 2 | -02 | 54 | |

* Replace the x by the desired housing style type 1 or 2.

1: Choke horizontal

2: Choke vertical

Test conditions:

Measuring frequency: 10 kHz; 50mV

Inductance tolerance: +50%, -30%

Resistance tolerance: max. ±15% @ 25 °C; < 20mΩ, 1 A; > 20mΩ ≤ 200mΩ, 100mA; > 200mΩ ≤ 2Ω, 10mA

Electrical characteristics @ 25 °C: ±2°C

Typical choke attenuation/resonance frequency characteristics

Per CISPR 17; 50 Ω/50 Ω asym

RN x02

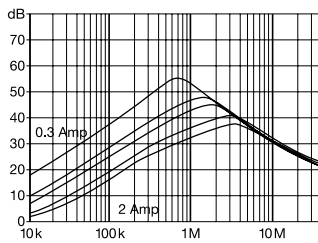

RN x12

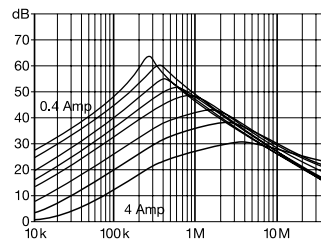

RN x14

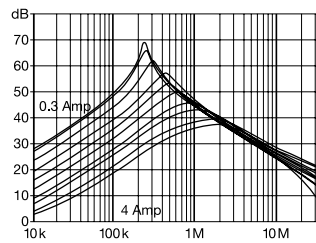

RN x22

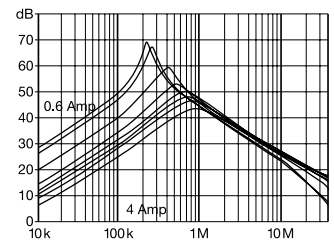

RN x42

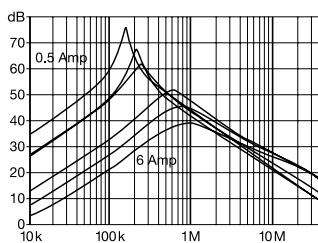

RN 143

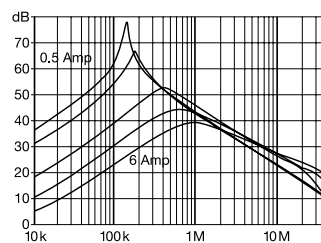

RN 152

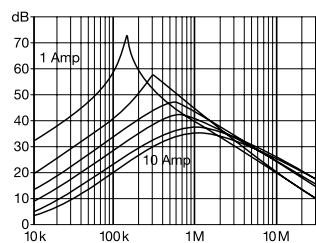

Typical saturation characteristics

Inductance (typical value in %) vs. nominal current (A DC)

RN x02 / RN x12 / RN x14 / RN x22

RN x42 / RN 143 / RN 152

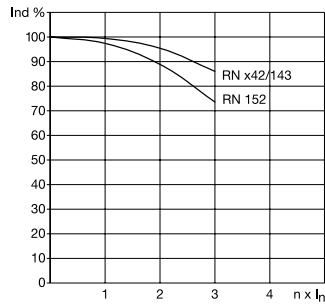
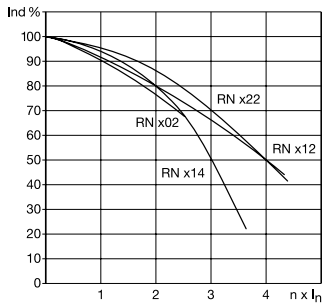

Mechanical data

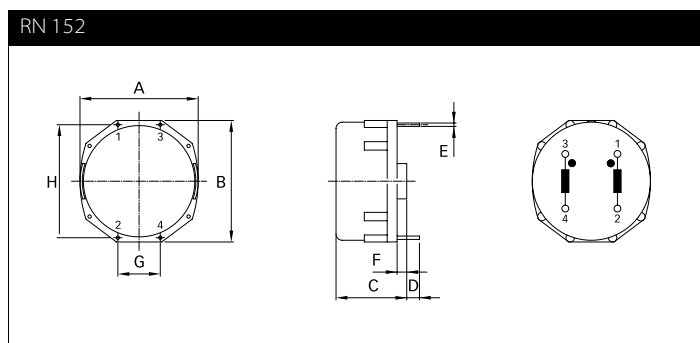
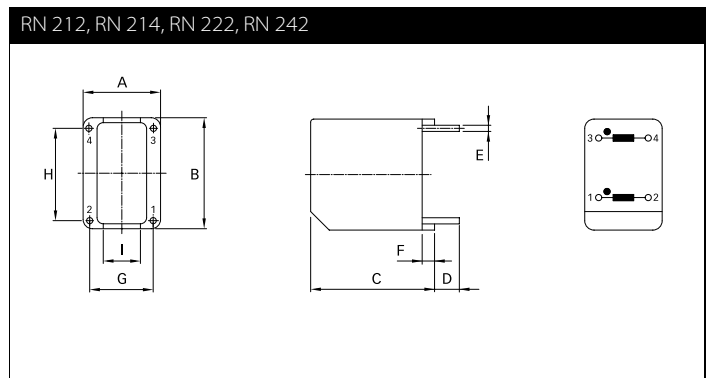
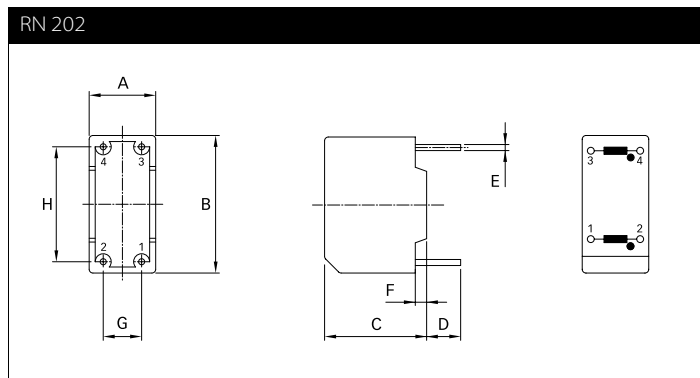
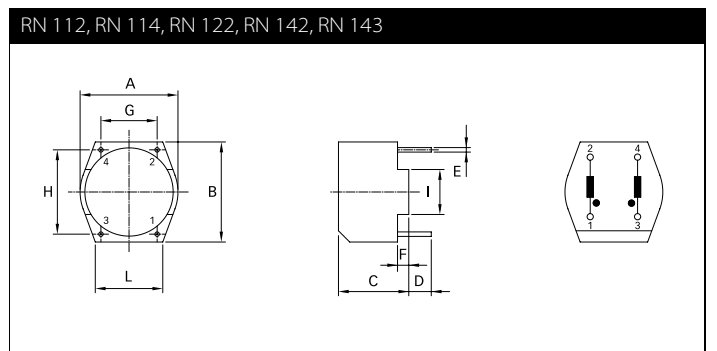
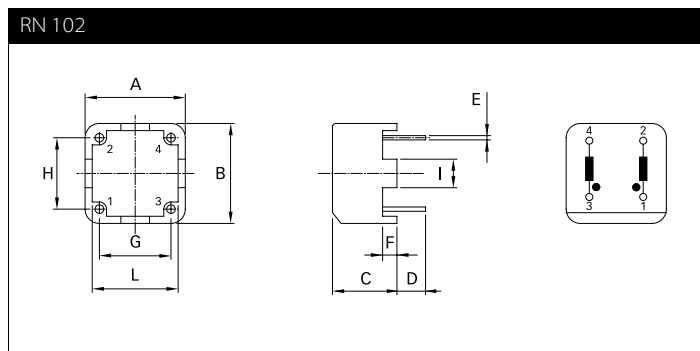

Dimensions

| | RN 102 | RN 112 | RN 114 | RN 122 | RN 202 | RN 212 | RN 214 | RN 222 | RN 142 | RN 143 | RN 242 | RN 152 | ToI. |
|----------|---------------|---------------|---------------|---------------|---------------|---------------|---------------|---------------|---------------|---------------|---------------|---------------|-------------|
| A | 14 | 17.1 | 21.5 | 27 | 8.8 | 12.5 | 15.5 | 18 | 32.5 | 32.5 | 18 | 41.8 | ±0.3 |
| B | 14 | 17.7 | 22.5 | 28 | 18.2 | 18 | 23 | 31 | 33.1 | 33.1 | 31 | 43 | ±0.3 |
| C | 9 | 12.6 | 13.2 | 16.5 | 13.5 | 20 | 25 | 29.3 | 19.7 | 19.7 | 34.3 | 25 | ±0.3 |
| D | 4 | 4 | 4 | 4 | 4.5 | 4 | 4 | 4 | 4.3 | 4.3 | 4.2 | 4.5 | ±0.5 |
| E | 0.6 | 0.8 | 0.8 | 0.8 | 0.8 | 0.8 | 0.8 | 0.8 | 0.8 | 0.8 | 0.8 | 1.2 | ±0.1 |
| F | 2 | 2 | | | 1.5 | 2 | | | | | | | |
| G | 10 | 10 | 12.5 | 15 | 5.08 | 10 | 12.5 | 15 | 20 | 20 | 15 | 15 | ±0.6 |
| H | 10 | 15 | 20.1 | 25 | 15.21 | 15 | 10 | 12.5 | 30 | 30 | 12.5 | 40 | ±0.6 |
| I | 4 | 8 | | | | | | | | | | | |
| L | 12 | 12 | | | | | | | | | | | |

All dimensions in mm; 1 inch = 25.4 mm
Tolerances according: ISO 2768-m / EN 22768-m

Please visit www.schaffner.com to find more details on filter connections.



Headquarters, global innovation and development center

Switzerland

Schaffner Group

Nordstrasse 11
4542 Luterbach
T +41 32 6816 626
F +41 32 6816 630
info@schaffner.com
<http://www.schaffner.com>



Sales and application centers

China

Schaffner EMC Ltd. Shanghai

T20-3, No 565 Chuangye Road
Pudong New Area
201201 Shanghai
T +86 21 3813 9500
F +86 21 3813 9501 / 02
cschina@schaffner.com
<http://www.schaffner.com.cn/>

Finland

Schaffner Oy

Sauvonrinne 19 H
08500 Lohja
T +358 19 35 72 71
finlandsales@schaffner.com

France

Schaffner EMC S.A.S.

112, Quai de Bezons
Boîte postale 133
95103 Argenteuil
T +33 1 34 34 30 60
F +33 1 39 47 02 28
francesales@schaffner.com

Germany

Schaffner Deutschland GmbH

Schoemperlenstrasse 12B
76185 Karlsruhe
T +49 721 56910
F +49 721 569110
germanysales@schaffner.com

Italy

Schaffner EMC S.r.l.

Via Galileo Galilei 47
20092 Cinisello Balsamo (MI)
T +39 02 66 04 30 45/47
F +39 02 61 23 943
italysales@schaffner.com

Japan

Schaffner EMC K.K.

1-32-12, Kamiyama, Setagaya-ku
7F Mitsui-seimei Sangenjaya Bldg.
154-0011 Tokyo
T +81 3 5712 3650
F +81 3 5712 3651
japansales@schaffner.com
<http://www.schaffner.jp>

Singapore

Schaffner EMC Pte Ltd.

Blk 3015A Ubi Road 1
05-09 Kampong Ubi Industrial Estate
408705 Singapore
T +65 6377 3283
F +65 6377 3281
singaporesales@schaffner.com

Spain

Schaffner EMC España

Calle Caléndula 93
Miniparc III, Edificio E
El Soto de la Moraleja
Alcobendas
28109 Madrid
T +34 618 176 133
spainsales@schaffner.com

Sweden

Schaffner EMC AB

Turebergstorg 1, 6
19147 Sollentuna
T +46 8 5792 1121 / 22
F +46 8 92 96 90
swedensales@schaffner.com

Switzerland

Schaffner EMV AG

Nordstrasse 11
4542 Luterbach
T +41 32 6816 626
F +41 32 6816 641
sales@schaffner.ch

Taiwan R.O.C.

Schaffner EMV Ltd.

6 Floor, No. 413
Rui Guang Road
114 Neihu District Taipei City
T +886 2 87525050
F +886 2 87518086
taiwansales@schaffner.com

Thailand

Schaffner EMC Co. Ltd.

Northern Region Industrial Estate
67 Moo 4 Tambon Ban Klang
Amphur Muang P.O. Box 14
51000 Lamphun
T +66 53 58 11 04
F +66 53 58 10 19
thailandsales@schaffner.com

UK

Schaffner Ltd.

5 Ashville Way
Molly Millars Lane
Wokingham
RG41 2PL Berkshire
T +44 118 9770070
F +44 118 9792969
uksales@schaffner.com
<http://www.schaffner.uk.com>

USA

Schaffner EMC Inc.

52 Mayfield Avenue
08837 Edison, New Jersey
T +1 800 367 5566
T +1 732 225 9533
F +1 732 225 4789
usasales@schaffner.com
<http://www.schaffner.com/us>

Schaffner MTC LLC

6722 Thirlane Road
24019 Roanoke, Virginia
T +1 276 228 7943
F +1 276 228 7953
<http://www.schaffner-mtc.com>

Schaffner Trencos LLC

2550 Brookpark Road
44134 Cleveland, Ohio
T +1 216 741 5282
F +1 216 741 4860
www.schaffner-trencos.com

To find your local partner within Schaffner's global network: www.schaffner.com

© 2014 Schaffner Group

The content of this document has been carefully checked and understood. However, neither Schaffner nor its subsidiaries assume any liability whatsoever for any errors or inaccuracies of this document and the consequences thereof. Published specifications are subject to change without notice. Product suitability for any area of application must ultimately be determined by the customer. In all cases, products must never be operated outside their published specifications. Schaffner does not guarantee the availability of all published products. This disclaimer shall be governed by substantive Swiss law and resulting disputes shall be settled by the courts at the place of business of Schaffner Holding AG. Latest publications and a complete disclaimer can be downloaded from the Schaffner website. All trademarks recognized.