

DS2003 High Current/Voltage Darlington Drivers

Check for Samples: [DS2003](#)

FEATURES

- Seven High Gain Darlington Pairs
- High Output Voltage ($V_{CE} = 50V$)
- High Output Current ($I_C = 350\text{ mA}$)
- TTL, PMOS, CMOS Compatible
- Suppression Diodes for Inductive Loads
- Extended Temperature Range

DESCRIPTION

The DS2003 comprises seven high voltage, high current NPN Darlington transistor pairs. All units feature a common emitter and open collector outputs. To maximize their effectiveness, these units contain suppression diodes for inductive loads and appropriate emitter base resistors for leakage.

The DS2003 has a series base resistor to each Darlington pair, thus allowing operation directly with TTL or CMOS operating at supply voltages of 5.0V.

The DS2003 offers solutions to a great many interface needs, including solenoids, relays, lamps, small motors, and LEDs. Applications requiring sink currents beyond the capability of a single output may be accommodated by paralleling the outputs.

Connection Diagram

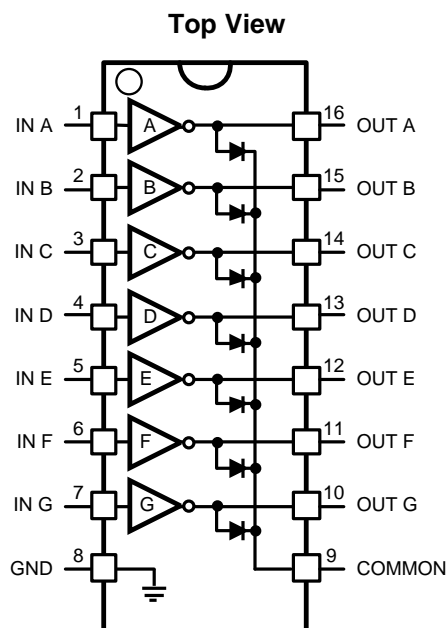

Figure 1.



Please be aware that an important notice concerning availability, standard warranty, and use in critical applications of Texas Instruments semiconductor products and disclaimers thereto appears at the end of this data sheet.

All trademarks are the property of their respective owners.



These devices have limited built-in ESD protection. The leads should be shorted together or the device placed in conductive foam during storage or handling to prevent electrostatic damage to the MOS gates.

Absolute Maximum Ratings⁽¹⁾⁽²⁾

Storage Temperature Range	-65°C to +150°C
Operating Temperature Range, T _A	
DS2003T	-40°C to +125°C
DS2003C	-40°C to +85°C
Junction Temperature Range, T _J	-40°C to +150°C
Lead Temperature	
Soldering, 10 seconds	265°C
ESD Ratings	
Human Body Model	+/-2000V
Machine Model	+/- 200V
Package Thermal Dissipation Ratings	
NFG0016E Package θ _{J-A}	88°C/W
D0016A Package θ _{J-A}	115°C/W
Input Voltage	-0.3V to 30V
Output Voltage	55V
Emitter-Base Voltage	6.0V
Continuous Collector Current	500 mA
Continuous Base Current	25 mA

- (1) "Absolute Maximum Ratings" are those values beyond which the safety of the device cannot be specified. They are not meant to imply that the devices should be operated at these limits. The [Electrical Characteristics](#) provide conditions for actual device operation.
- (2) If Military/Aerospace specified devices are required, please contact the TI Sales Office/Distributors for availability and specifications.

Electrical Characteristics

T_A = 25°C, unless otherwise specified⁽¹⁾

Parameter		Test Conditions	Min	Typ	Max	Units
I _{CEX}	Output Leakage Current	T _A = 25°C, V _{CE} = 50V (Figure 6)			20	μA
		T _A = 85°C, V _{CE} = 50V (Figure 6)			100	
		T _A = 125°C, V _{CE} = 50V (Figure 6) for DS2003T			150	
V _{CE(Sat)}	Collector-Emitter Saturation Voltage	I _C = 350mA, I _B = 500μA (Figure 8) ⁽²⁾		1.25	1.6	V
		I _C = 200mA, I _B = 350μA (Figure 8)		1.1	1.3	
		I _C = 100mA, I _B = 250μA (Figure 8)		0.9	1.1	
I _{I(ON)}	Input Current	V _I = 3.85V (Figure 9)		0.93	1.35	mA
I _{I(OFF)}	Input Current ⁽³⁾	I _C = 500μA (Figure 10)	50	100		μA
		T _A = +25°C	50	100		
		T _A = +85°C	25	50		
		T _A = +125C for DS2003T	10	25		
V _{I(ON)}	Input Voltage ⁽⁴⁾	V _{CE} = 2.0V, I _C = 200mA (Figure 11)			2.4	V
		V _{CE} = 2.0V, I _C = 250mA (Figure 11)			2.7	
		V _{CE} = 2.0V, I _C = 300mA (Figure 11)			3.0	
C _I	Input Capacitance			15	30	pF
t _{PLH}	Turn-On Delay	0.5 V _I to 0.5 V _O			1.0	μs
t _{PHL}	Turn-Off Delay	0.5 V _I to 0.5 V _O			1.0	μs

- (1) All limits apply to the complete Darlington series except as specified for a single device type.
- (2) Under normal operating conditions these units will sustain 350 mA per output with V_{CE(Sat)} = 1.6V at 70°C with a pulse width of 20 ms and a duty cycle of 30%.
- (3) The I_{I(OFF)} current limit ensured against partial turn-on of the output.
- (4) The V_{I(ON)} voltage limit ensures a minimum output sink current per the specified test conditions.

Electrical Characteristics (continued)
 $T_A = 25^\circ\text{C}$, unless otherwise specified ⁽¹⁾

Parameter		Test Conditions	Min	Typ	Max	Units
I_R	Clamp Diode Leakage Current	$V_R = 50\text{V}$ (Figure 12)				μA
		$T_A = 25^\circ\text{C}$		5	10	
		$T_A = 85^\circ\text{C}$		10	50	
		$T_A = 125^\circ\text{C}$ for DS2003T		20	100	
V_F	Clamp Diode Forward Voltage	$I_F = 350\text{mA}$ (Figure 13)		1.7	2.0	V

Typical Performance Characteristics

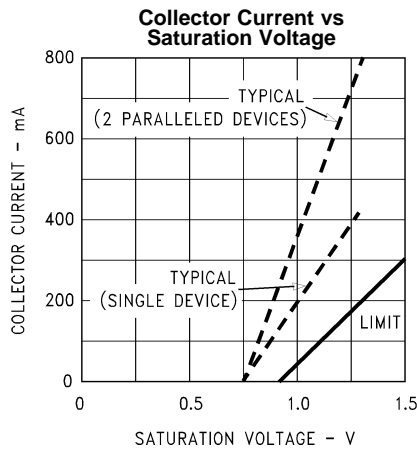

Figure 2.

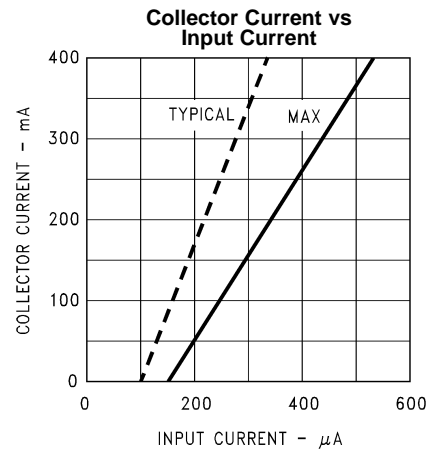

Figure 3.

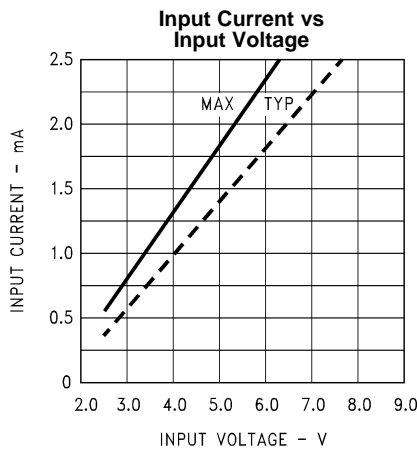

Figure 4.

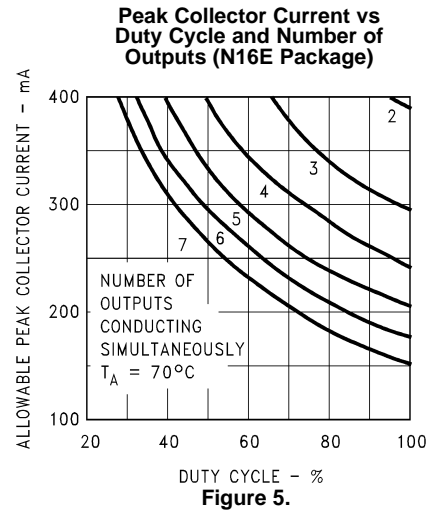
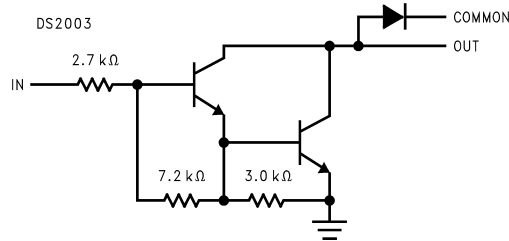

Figure 5.

EQUIVALENT CIRCUITS



Test Circuits

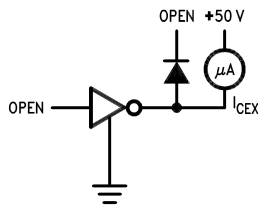

Figure 6.

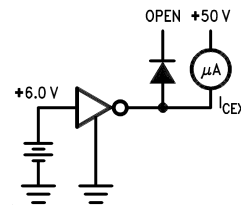

Figure 7.

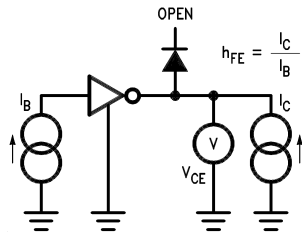

Figure 8.

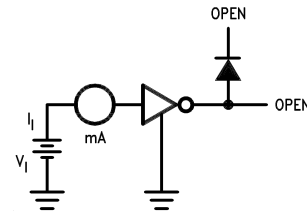

Figure 9.

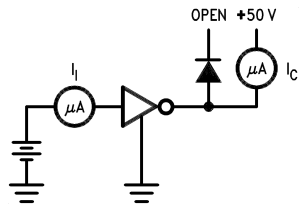

Figure 10.

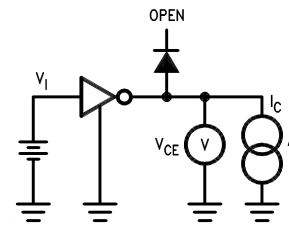

Figure 11.

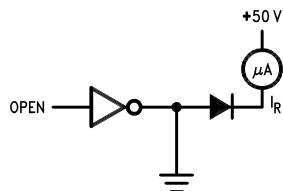

Figure 12.

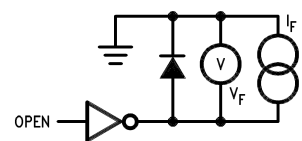

Figure 13.

Typical Applications

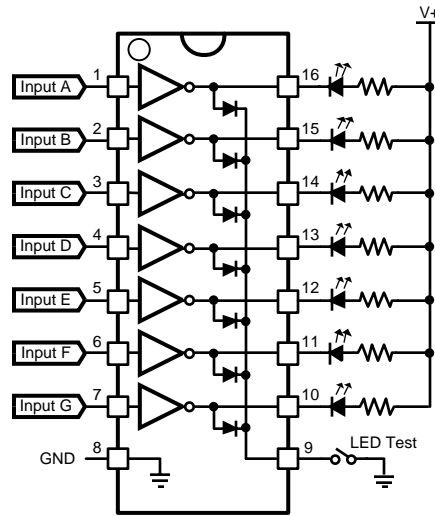

Figure 14. Typical LED Driver

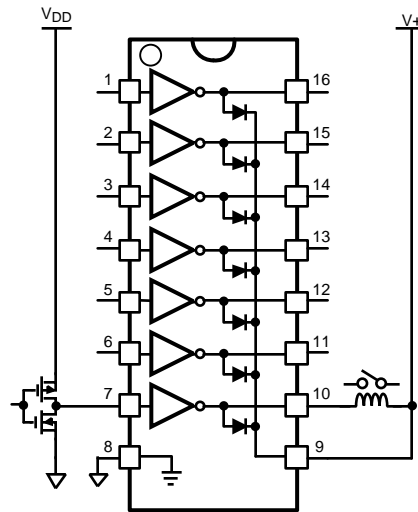





Figure 15. Typical Relay Driver

REVISION HISTORY

Changes from Revision I (April 2013) to Revision J	Page
<hr/> <ul style="list-style-type: none">• Changed layout of National Data Sheet to TI format	6

PACKAGING INFORMATION

Orderable Device	Status (1)	Package Type	Package Drawing	Pins	Package Qty	Eco Plan (2)	Lead/Ball Finish (6)	MSL Peak Temp (3)	Op Temp (°C)	Device Marking (4/5)	Samples
DS2003CM	NRND	SOIC	D	16	48	TBD	Call TI	Call TI	-40 to 125	DS2003CM	
DS2003CM/NOPB	ACTIVE	SOIC	D	16	48	Green (RoHS & no Sb/Br)	CU SN	Level-1-260C-UNLIM	-40 to 125	DS2003CM	
DS2003CMX/NOPB	ACTIVE	SOIC	D	16	2500	Green (RoHS & no Sb/Br)	CU SN	Level-1-260C-UNLIM	-40 to 125	DS2003CM	
DS2003TM	NRND	SOIC	D	16	48	TBD	Call TI	Call TI	-40 to 125	DS2003TM	
DS2003TM/NOPB	ACTIVE	SOIC	D	16	48	Green (RoHS & no Sb/Br)	CU SN	Level-1-260C-UNLIM	-40 to 125	DS2003TM	
DS2003TMX	NRND	SOIC	D	16	2500	TBD	Call TI	Call TI	-40 to 125	DS2003TM	
DS2003TMX/NOPB	ACTIVE	SOIC	D	16	2500	Green (RoHS & no Sb/Br)	CU SN	Level-1-260C-UNLIM	-40 to 125	DS2003TM	

(1) The marketing status values are defined as follows:

ACTIVE: Product device recommended for new designs.

LIFEBUY: TI has announced that the device will be discontinued, and a lifetime-buy period is in effect.

NRND: Not recommended for new designs. Device is in production to support existing customers, but TI does not recommend using this part in a new design.

PREVIEW: Device has been announced but is not in production. Samples may or may not be available.

OBSOLETE: TI has discontinued the production of the device.

(2) Eco Plan - The planned eco-friendly classification: Pb-Free (RoHS), Pb-Free (RoHS Exempt), or Green (RoHS & no Sb/Br) - please check <http://www.ti.com/productcontent> for the latest availability information and additional product content details.

TBD: The Pb-Free/Green conversion plan has not been defined.

Pb-Free (RoHS): TI's terms "Lead-Free" or "Pb-Free" mean semiconductor products that are compatible with the current RoHS requirements for all 6 substances, including the requirement that lead not exceed 0.1% by weight in homogeneous materials. Where designed to be soldered at high temperatures, TI Pb-Free products are suitable for use in specified lead-free processes.

Pb-Free (RoHS Exempt): This component has a RoHS exemption for either 1) lead-based flip-chip solder bumps used between the die and package, or 2) lead-based die adhesive used between the die and leadframe. The component is otherwise considered Pb-Free (RoHS compatible) as defined above.

Green (RoHS & no Sb/Br): TI defines "Green" to mean Pb-Free (RoHS compatible), and free of Bromine (Br) and Antimony (Sb) based flame retardants (Br or Sb do not exceed 0.1% by weight in homogeneous material)

(3) MSL, Peak Temp. - The Moisture Sensitivity Level rating according to the JEDEC industry standard classifications, and peak solder temperature.

(4) There may be additional marking, which relates to the logo, the lot trace code information, or the environmental category on the device.

(5) Multiple Device Markings will be inside parentheses. Only one Device Marking contained in parentheses and separated by a "~" will appear on a device. If a line is indented then it is a continuation of the previous line and the two combined represent the entire Device Marking for that device.

⁽⁶⁾ Lead/Ball Finish - Orderable Devices may have multiple material finish options. Finish options are separated by a vertical ruled line. Lead/Ball Finish values may wrap to two lines if the finish value exceeds the maximum column width.

Important Information and Disclaimer: The information provided on this page represents TI's knowledge and belief as of the date that it is provided. TI bases its knowledge and belief on information provided by third parties, and makes no representation or warranty as to the accuracy of such information. Efforts are underway to better integrate information from third parties. TI has taken and continues to take reasonable steps to provide representative and accurate information but may not have conducted destructive testing or chemical analysis on incoming materials and chemicals. TI and TI suppliers consider certain information to be proprietary, and thus CAS numbers and other limited information may not be available for release.

In no event shall TI's liability arising out of such information exceed the total purchase price of the TI part(s) at issue in this document sold by TI to Customer on an annual basis.

TAPE AND REEL INFORMATION



QUADRANT ASSIGNMENTS FOR PIN 1 ORIENTATION IN TAPE



*All dimensions are nominal

Device	Package Type	Package Drawing	Pins	SPQ	Reel Diameter (mm)	Reel Width W1 (mm)	A0 (mm)	B0 (mm)	K0 (mm)	P1 (mm)	W (mm)	Pin1 Quadrant
DS2003TMX	SOIC	D	16	2500	330.0	16.4	6.5	10.3	2.3	8.0	16.0	Q1
DS2003TMX/NOPB	SOIC	D	16	2500	330.0	16.4	6.5	10.3	2.3	8.0	16.0	Q1

TAPE AND REEL BOX DIMENSIONS

*All dimensions are nominal

Device	Package Type	Package Drawing	Pins	SPQ	Length (mm)	Width (mm)	Height (mm)
DS2003TMX	SOIC	D	16	2500	367.0	367.0	35.0
DS2003TMX/NOPB	SOIC	D	16	2500	367.0	367.0	35.0

D (R-PDSO-G16)

PLASTIC SMALL OUTLINE



- NOTES:
- A. All linear dimensions are in inches (millimeters).
 - B. This drawing is subject to change without notice.
 - C. Body length does not include mold flash, protrusions, or gate burrs. Mold flash, protrusions, or gate burrs shall not exceed 0.006 (0,15) each side.
 - D. Body width does not include interlead flash. Interlead flash shall not exceed 0.017 (0,43) each side.
 - E. Reference JEDEC MS-012 variation AC.

IMPORTANT NOTICE

Texas Instruments Incorporated and its subsidiaries (TI) reserve the right to make corrections, enhancements, improvements and other changes to its semiconductor products and services per JESD46, latest issue, and to discontinue any product or service per JESD48, latest issue. Buyers should obtain the latest relevant information before placing orders and should verify that such information is current and complete. All semiconductor products (also referred to herein as "components") are sold subject to TI's terms and conditions of sale supplied at the time of order acknowledgment.

TI warrants performance of its components to the specifications applicable at the time of sale, in accordance with the warranty in TI's terms and conditions of sale of semiconductor products. Testing and other quality control techniques are used to the extent TI deems necessary to support this warranty. Except where mandated by applicable law, testing of all parameters of each component is not necessarily performed.

TI assumes no liability for applications assistance or the design of Buyers' products. Buyers are responsible for their products and applications using TI components. To minimize the risks associated with Buyers' products and applications, Buyers should provide adequate design and operating safeguards.

TI does not warrant or represent that any license, either express or implied, is granted under any patent right, copyright, mask work right, or other intellectual property right relating to any combination, machine, or process in which TI components or services are used. Information published by TI regarding third-party products or services does not constitute a license to use such products or services or a warranty or endorsement thereof. Use of such information may require a license from a third party under the patents or other intellectual property of the third party, or a license from TI under the patents or other intellectual property of TI.

Reproduction of significant portions of TI information in TI data books or data sheets is permissible only if reproduction is without alteration and is accompanied by all associated warranties, conditions, limitations, and notices. TI is not responsible or liable for such altered documentation. Information of third parties may be subject to additional restrictions.

Resale of TI components or services with statements different from or beyond the parameters stated by TI for that component or service voids all express and any implied warranties for the associated TI component or service and is an unfair and deceptive business practice. TI is not responsible or liable for any such statements.

Buyer acknowledges and agrees that it is solely responsible for compliance with all legal, regulatory and safety-related requirements concerning its products, and any use of TI components in its applications, notwithstanding any applications-related information or support that may be provided by TI. Buyer represents and agrees that it has all the necessary expertise to create and implement safeguards which anticipate dangerous consequences of failures, monitor failures and their consequences, lessen the likelihood of failures that might cause harm and take appropriate remedial actions. Buyer will fully indemnify TI and its representatives against any damages arising out of the use of any TI components in safety-critical applications.

In some cases, TI components may be promoted specifically to facilitate safety-related applications. With such components, TI's goal is to help enable customers to design and create their own end-product solutions that meet applicable functional safety standards and requirements. Nonetheless, such components are subject to these terms.

No TI components are authorized for use in FDA Class III (or similar life-critical medical equipment) unless authorized officers of the parties have executed a special agreement specifically governing such use.

Only those TI components which TI has specifically designated as military grade or "enhanced plastic" are designed and intended for use in military/aerospace applications or environments. Buyer acknowledges and agrees that any military or aerospace use of TI components which have **not** been so designated is solely at the Buyer's risk, and that Buyer is solely responsible for compliance with all legal and regulatory requirements in connection with such use.

TI has specifically designated certain components as meeting ISO/TS16949 requirements, mainly for automotive use. In any case of use of non-designated products, TI will not be responsible for any failure to meet ISO/TS16949.

Products

Audio	www.ti.com/audio
Amplifiers	amplifier.ti.com
Data Converters	dataconverter.ti.com
DLP® Products	www.dlp.com
DSP	dsp.ti.com
Clocks and Timers	www.ti.com/clocks
Interface	interface.ti.com
Logic	logic.ti.com
Power Mgmt	power.ti.com
Microcontrollers	microcontroller.ti.com
RFID	www.ti-rfid.com
OMAP Applications Processors	www.ti.com/omap
Wireless Connectivity	www.ti.com/wirelessconnectivity

Applications

Automotive and Transportation	www.ti.com/automotive
Communications and Telecom	www.ti.com/communications
Computers and Peripherals	www.ti.com/computers
Consumer Electronics	www.ti.com/consumer-apps
Energy and Lighting	www.ti.com/energy
Industrial	www.ti.com/industrial
Medical	www.ti.com/medical
Security	www.ti.com/security
Space, Avionics and Defense	www.ti.com/space-avionics-defense
Video and Imaging	www.ti.com/video

TI E2E Community

e2e.ti.com