

# RF Power Field Effect Transistor

## N-Channel Enhancement-Mode Lateral MOSFET

Designed for pulsed wideband applications operating at frequencies between 3100 and 3500 MHz.

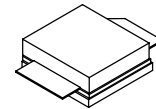
- Typical Pulsed Performance:  $V_{DD} = 32$  Volts,  $I_{DQ} = 50$  mA,  
 $P_{out} = 15$  Watts Peak (3 Watts Avg.), Pulsed Signal,  $f = 3500$  MHz,  
Pulse Width = 100  $\mu$ sec, Duty Cycle = 20%  
Power Gain — 16 dB  
Drain Efficiency — 41%
- Typical WiMAX Performance:  $V_{DD} = 32$  Volts,  $I_{DQ} = 150$  mA,  
 $P_{out} = 1.8$  Watts Avg.,  $f = 3500$  MHz, 802.16d, 64 QAM  $3/4$ , 4 Bursts,  
10 MHz Channel Bandwidth, Input Signal PAR = 9.5 dB @ 0.01%  
Probability on CCDF  
Power Gain — 18 dB  
Drain Efficiency — 16%  
RCE — -33 dB (EVM — 2.2% rms)
- Capable of Handling 10:1 VSWR, @ 32 Vdc, 3300 MHz, 15 Watts Peak Power
- Capable of Handling 3 dB Overdrive @ 32 Vdc

### Features

- Characterized with Series Equivalent Large-Signal Impedance Parameters
- Internally Matched for Ease of Use
- Integrated ESD Protection
- Greater Negative Gate-Source Voltage Range for Improved Class C Operation
- RoHS Compliant
- In Tape and Reel. R3 Suffix = 250 Units, 32 mm Tape Width, 13 inch Reel.

**MRF7S35015HSR3**

**3100-3500 MHz, 15 W PEAK, 32 V  
PULSED  
LATERAL N-CHANNEL  
RF POWER MOSFET**



**CASE 465J-02, STYLE 1  
NI-400S-240**

**Table 1. Maximum Ratings**

Rating	Symbol	Value	Unit
Drain-Source Voltage	$V_{DSS}$	-0.5, +65	Vdc
Gate-Source Voltage	$V_{GS}$	-6.0, +10	Vdc
Operating Voltage	$V_{DD}$	32, +0	Vdc
Storage Temperature Range	$T_{stg}$	- 65 to +150	$^{\circ}$ C
Case Operating Temperature	$T_C$	150	$^{\circ}$ C
Operating Junction Temperature (1,2)	$T_J$	225	$^{\circ}$ C

**Table 2. Thermal Characteristics**

Characteristic	Symbol	Value (2,3)	Unit
Thermal Resistance, Junction to Case Case Temperature 80 $^{\circ}$ C, 15 W Pulsed, 100 $\mu$ sec Pulse Width, 20% Duty Cycle Case Temperature 81 $^{\circ}$ C, 15 W Pulsed, 500 $\mu$ sec Pulse Width, 10% Duty Cycle	$R_{\theta JC}$	0.60 0.73	$^{\circ}$ C/W

1. Continuous use at maximum temperature will affect MTTF.
2. MTTF calculator available at <http://www.freescale.com/rf>. Select Software & Tools/Development Tools/Calculators to access MTTF calculators by product.
3. Refer to AN1955, *Thermal Measurement Methodology of RF Power Amplifiers*. Go to <http://www.freescale.com/rf>. Select Documentation/Application Notes - AN1955.

**Table 3. ESD Protection Characteristics**

Test Methodology	Class
Human Body Model (per JESD22-A114)	1B (Minimum)
Machine Model (per EIA/JESD22-A115)	A (Minimum)
Charge Device Model (per JESD22-C101)	IV (Minimum)

**Table 4. Electrical Characteristics** ( $T_C = 25^\circ\text{C}$  unless otherwise noted)

Characteristic	Symbol	Min	Typ	Max	Unit
----------------	--------	-----	-----	-----	------

**Off Characteristics**

Gate-Source Leakage Current ( $V_{GS} = 5\text{ Vdc}$ , $V_{DS} = 0\text{ Vdc}$ )	$I_{GSS}$	—	—	1	$\mu\text{Adc}$
Zero Gate Voltage Drain Leakage Current ( $V_{DS} = 32\text{ Vdc}$ , $V_{GS} = 0\text{ Vdc}$ )	$I_{DSS}$	—	—	2	$\mu\text{Adc}$
Zero Gate Voltage Drain Leakage Current ( $V_{DS} = 65\text{ Vdc}$ , $V_{GS} = 0\text{ Vdc}$ )	$I_{DSS}$	—	—	10	$\mu\text{Adc}$

**On Characteristics**

Gate Threshold Voltage ( $V_{DS} = 10\text{ Vdc}$ , $I_D = 33.5\ \mu\text{Adc}$ )	$V_{GS(th)}$	1.2	2	2.7	Vdc
Gate Quiescent Voltage ( $V_{DD} = 32\text{ Vdc}$ , $I_D = 50\text{ mAdc}$ , Measured in Functional Test)	$V_{GS(Q)}$	1.8	2.5	3.3	Vdc
Drain-Source On-Voltage ( $V_{GS} = 10\text{ Vdc}$ , $I_D = 300\text{ mAdc}$ )	$V_{DS(on)}$	0.1	1.7	0.3	Vdc

**Dynamic Characteristics (1)**

Reverse Transfer Capacitance ( $V_{DS} = 32\text{ Vdc} \pm 30\text{ mV(rms)ac}$ @ 1 MHz, $V_{GS} = 0\text{ Vdc}$ )	$C_{rss}$	—	0.12	—	pF
Output Capacitance ( $V_{DS} = 32\text{ Vdc} \pm 30\text{ mV(rms)ac}$ @ 1 MHz, $V_{GS} = 0\text{ Vdc}$ )	$C_{oss}$	—	92	—	pF
Input Capacitance ( $V_{DS} = 32\text{ Vdc}$ , $V_{GS} = 0\text{ Vdc} \pm 30\text{ mV(rms)ac}$ @ 1 MHz)	$C_{iss}$	—	46	—	pF

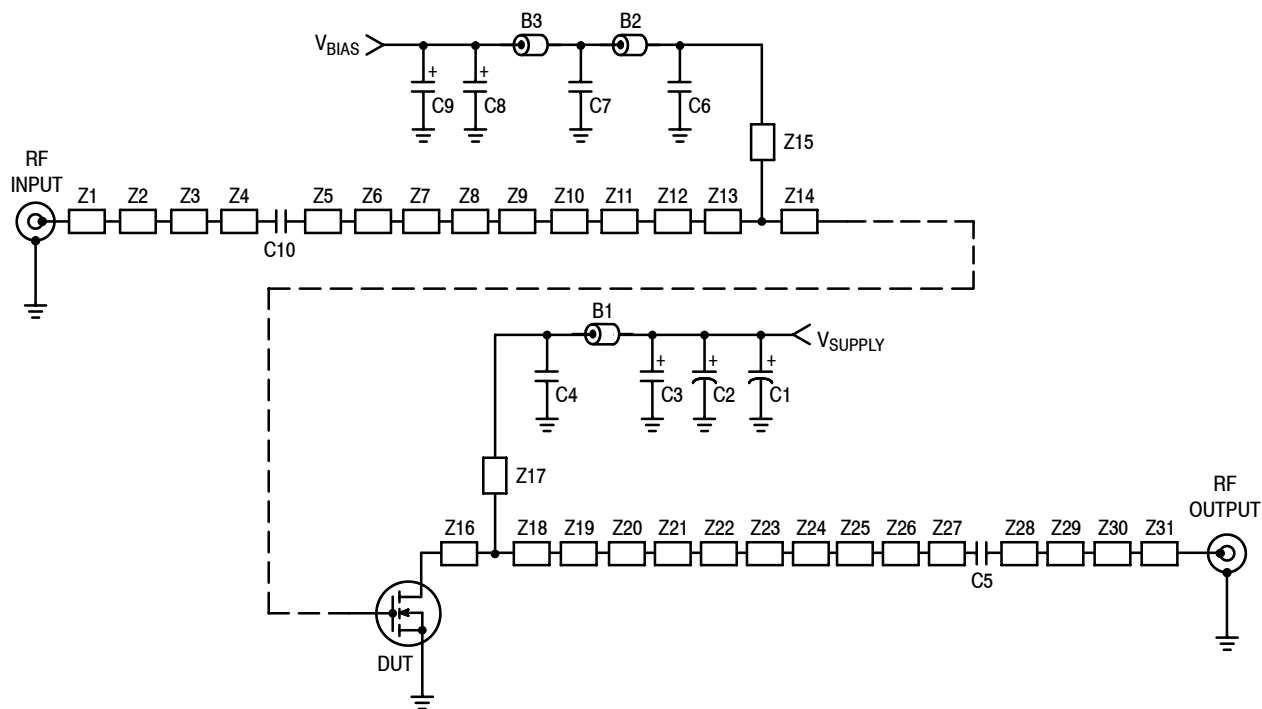
**Functional Tests** (In Freescale Test Fixture, 50 ohm system)  $V_{DD} = 32\text{ Vdc}$ ,  $I_{DQ} = 50\text{ mA}$ ,  $P_{out} = 15\text{ W Peak}$  (3 W Avg.),  $f = 3100\text{ MHz}$  and  $f = 3500\text{ MHz}$ , Pulsed, 100  $\mu\text{sec}$  Pulse Width, 20% Duty Cycle, 25 ns Input Rise Time

Power Gain	$G_{ps}$	13	16	19	dB
Drain Efficiency	$\eta_D$	38	41	—	%
Input Return Loss	IRL	—	-12	-7	dB

**Pulsed RF Performance** (In Freescale Application Test Fixture, 50 ohm system)  $V_{DD} = 32\text{ Vdc}$ ,  $I_{DQ} = 50\text{ mA}$ ,  $P_{out} = 15\text{ W Peak}$  (3 W Avg.),  $f = 3100\text{ MHz}$  and  $f = 3500\text{ MHz}$ , Pulsed, 100  $\mu\text{sec}$  Pulse Width, 20% Duty Cycle, 25 ns Input Rise Time

Output Pulse Droop (500 $\mu\text{sec}$ Pulse Width, 10% Duty Cycle)	$DRP_{out}$	—	0.2	—	dB
Load Mismatch Tolerance (VSWR = 10:1 at all Phase Angles)	VSWR-T	No Degradation in Output Power			

1. Part internally matched both on input and output.



Z1	0.375" x 0.071" Microstrip	Z18	0.078" x 0.454" Microstrip
Z2	0.126" x 0.524" Microstrip	Z19	0.055" x 0.244" Microstrip
Z3	0.079" x 0.016" Microstrip	Z20	0.630" x 0.073" Microstrip
Z4	0.153" x 0.071" Microstrip	Z21	0.218" x 0.038" Microstrip
Z5	0.076" x 0.520" Microstrip	Z22	0.060" x 0.552" Microstrip
Z6	0.037" x 0.252" Microstrip	Z23	0.079" x 0.038" Microstrip
Z7	0.322" x 0.073" Microstrip	Z24	0.062" x 0.526" Microstrip
Z8	0.123" x 0.440" Microstrip	Z25	0.032" x 0.070" Microstrip
Z9	0.048" x 0.073" Microstrip	Z26	0.110" x 0.526" Microstrip
Z10	0.081" x 0.184" Microstrip	Z27	0.053" x 0.072" Microstrip
Z11	0.030" x 0.262" Microstrip	Z28	0.028" x 0.070" Microstrip
Z12	0.525" x 0.336" Microstrip	Z29	0.098" x 0.148" Microstrip
Z13	0.182" x 0.466" Microstrip	Z30	0.062" x 0.526" Microstrip
Z14	0.077" x 0.466" Microstrip	Z31	0.529" x 0.070" Microstrip
Z15*	0.603" x 0.048" Microstrip	PCB	Arlon CuClad 250GX-0300-55-22, 0.030", $\epsilon_r = 2.55$
Z16	0.063" x 0.618" Microstrip		
Z17*	0.534" x 0.040" Microstrip		

\* Line length includes microstrip bends

**Figure 1. MRF7S35015HSR3 Test Circuit Schematic**

**Table 5. MRF7S35015HSR3 Test Circuit Component Designations and Values**

Part	Description	Part Number	Manufacturer
B1*	Long Ferrite Bead	2743021447	Fair-Rite
B2, B3	Short Ferrite Beads	2743019447	Fair-Rite
C1	470 $\mu$ F, 63 V Electrolytic Capacitor	477KXM063M	Illinois Cap
C2	47 $\mu$ F, 50 V Electrolytic Capacitor	476KXM050M	Illinois Cap
C3, C9	22 $\mu$ F, 35 V Tantalum Capacitors	T491X226K035AT	Kemet
C4, C5, C10	2.7 pF Chip Capacitors	ATC100B2R7BT500XT	ATC
C6	0.8 pF Chip Capacitor	ATC100B0R8BT500XT	ATC
C7	0.1 $\mu$ F Chip Capacitor	CDR33BX104AKYS	AVX
C8	22 $\mu$ F, 25 V Tantalum Capacitor	T491D226K025AT	Kemet

\*B1 is removed for WiMAX circuit performance.

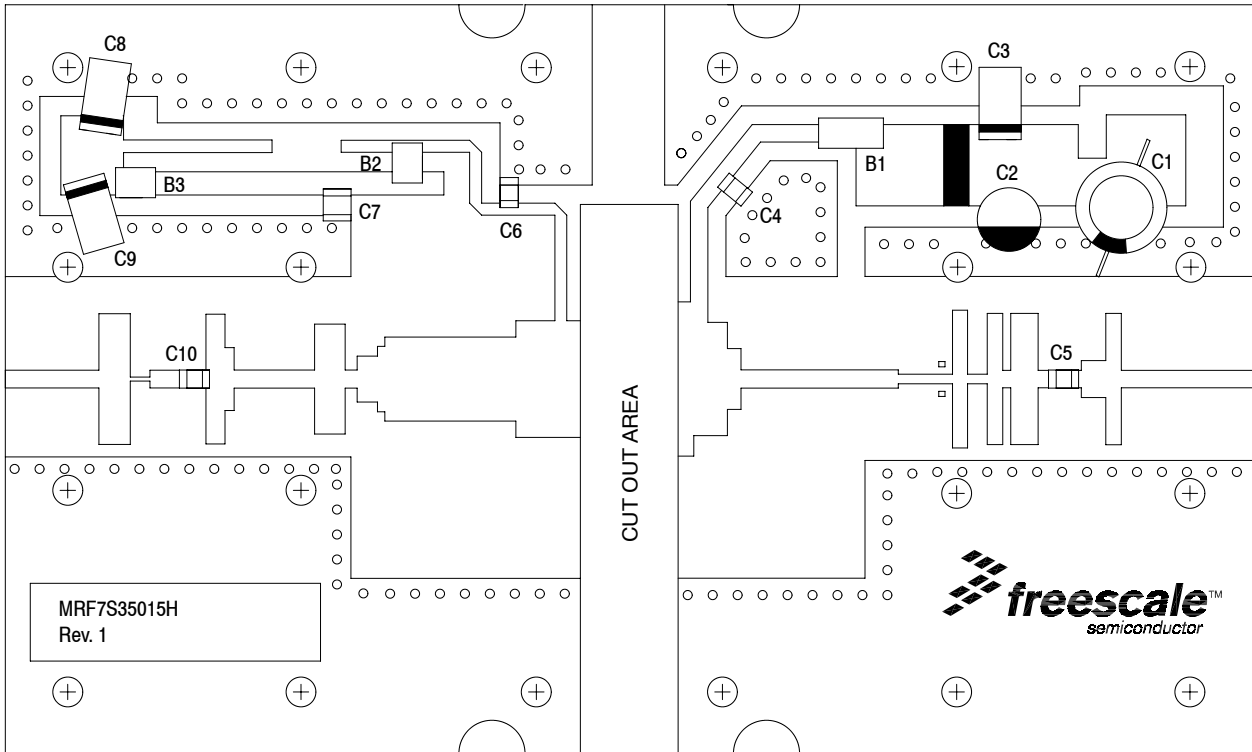
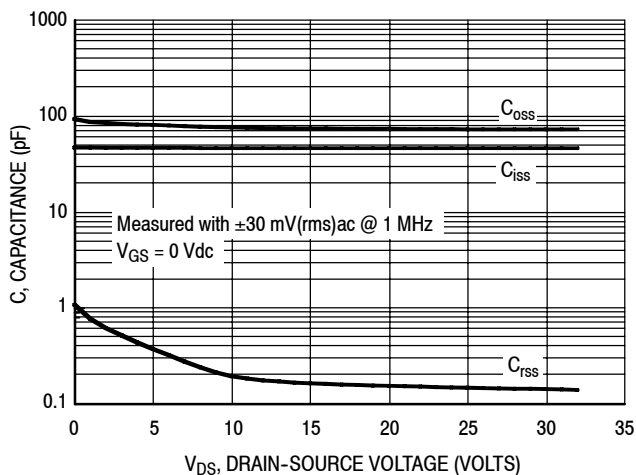
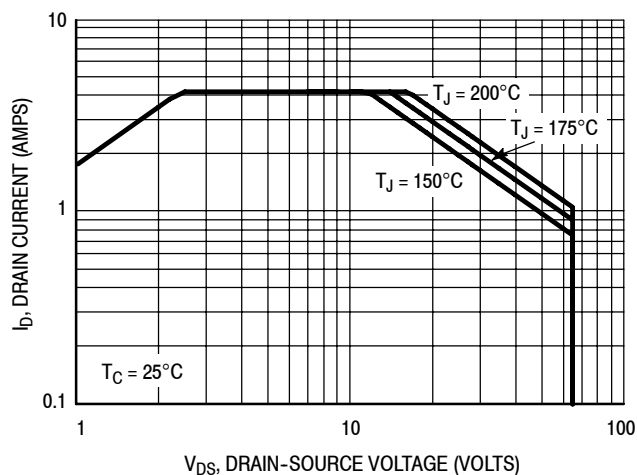


Figure 2. MRF7S35015HSR3 Test Circuit Component Layout

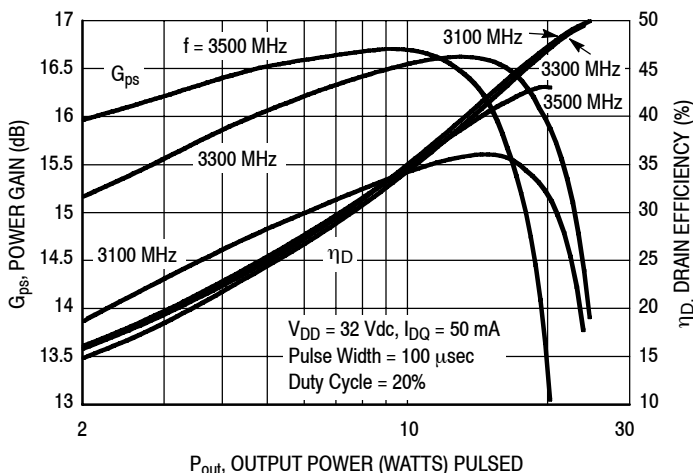
## TYPICAL CHARACTERISTICS



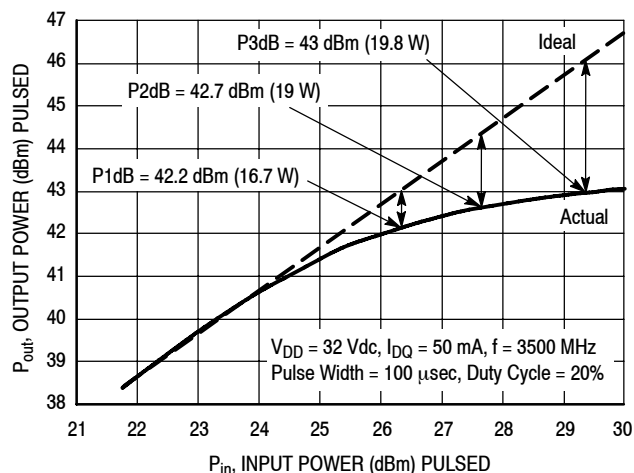
**Figure 3. Capacitance versus Drain-Source Voltage**



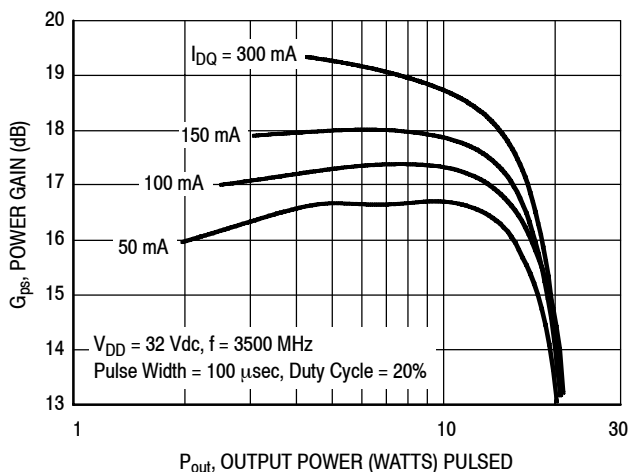
**Figure 4. DC Safe Operating Area**



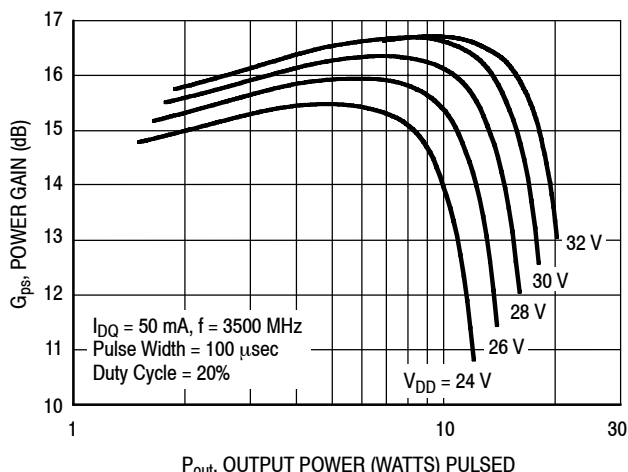
**Figure 5. Pulsed Power Gain and Drain Efficiency versus Output Power**



**Figure 6. Pulsed Output Power versus Input Power**

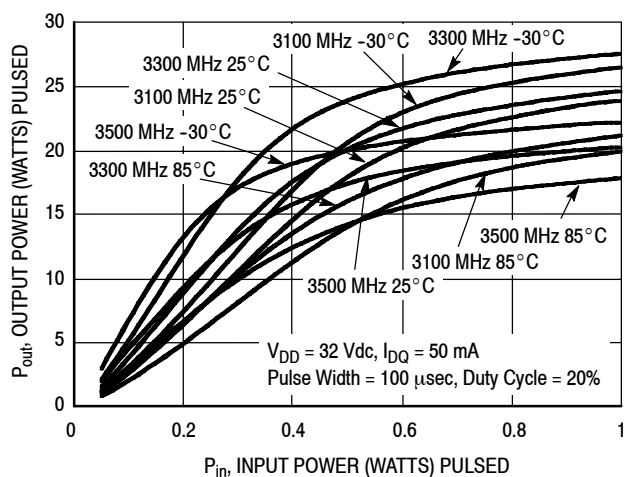


**Figure 7. Pulsed Power Gain versus Output Power**

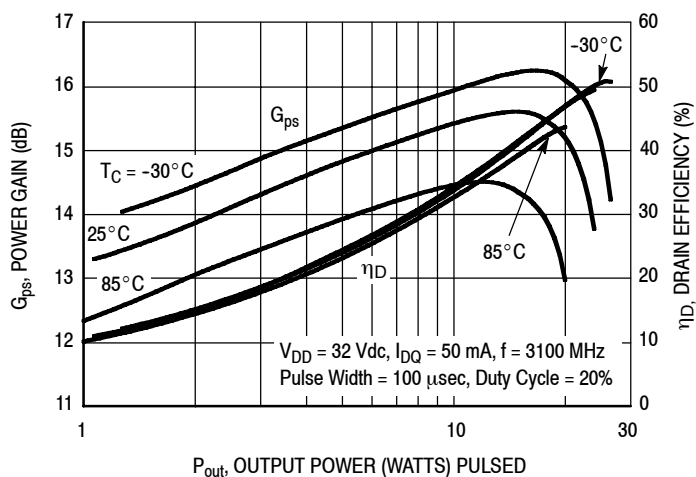


**Figure 8. Pulsed Power Gain versus Output Power**

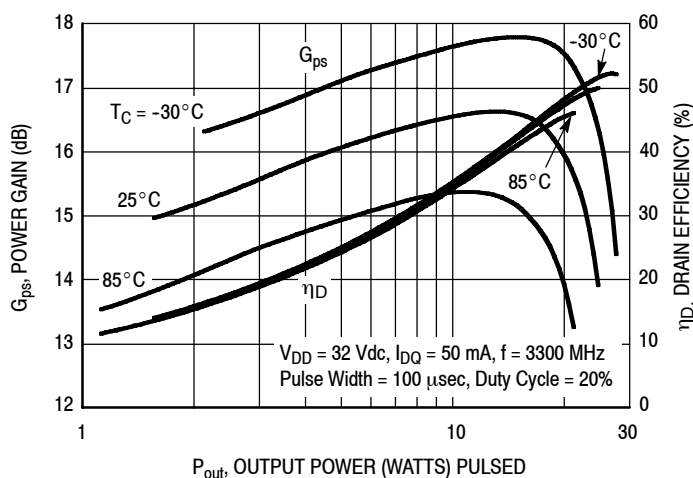
## TYPICAL CHARACTERISTICS



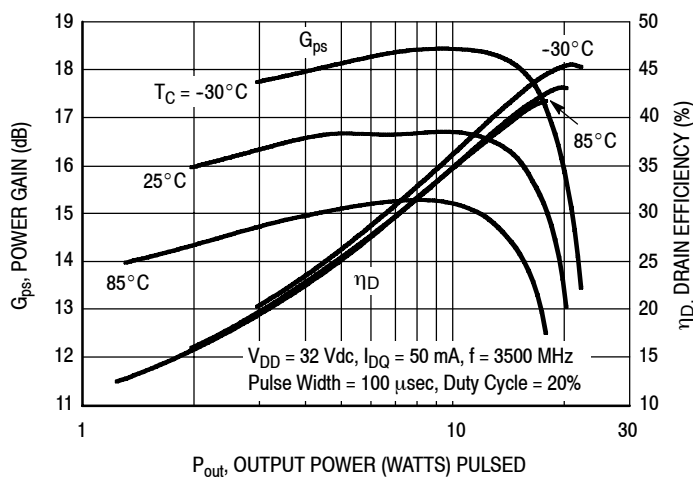
**Figure 9. Pulsed Output Power versus Input Power**



**Figure 10. Pulsed Power Gain and Drain Efficiency versus Output Power — 3100 MHz**

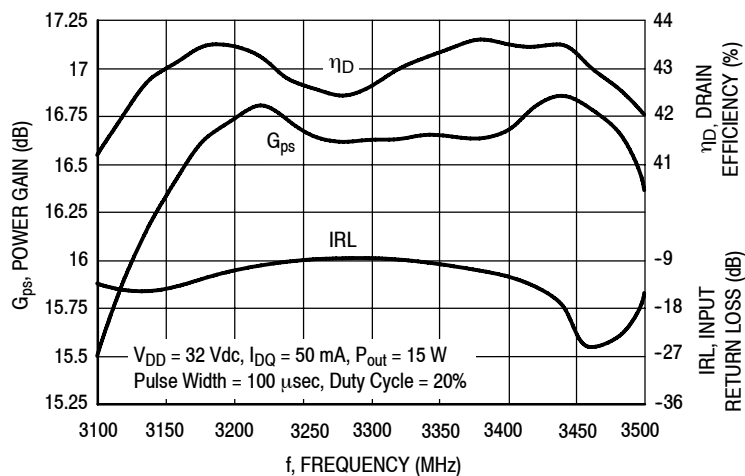


**Figure 11. Pulsed Power Gain and Drain Efficiency versus Output Power — 3300 MHz**

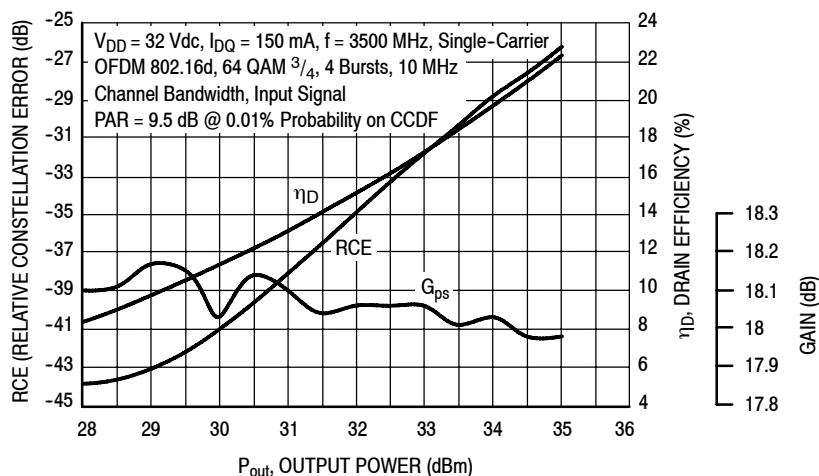


**Figure 12. Pulsed Power Gain and Drain Efficiency versus Output Power — 3500 MHz**

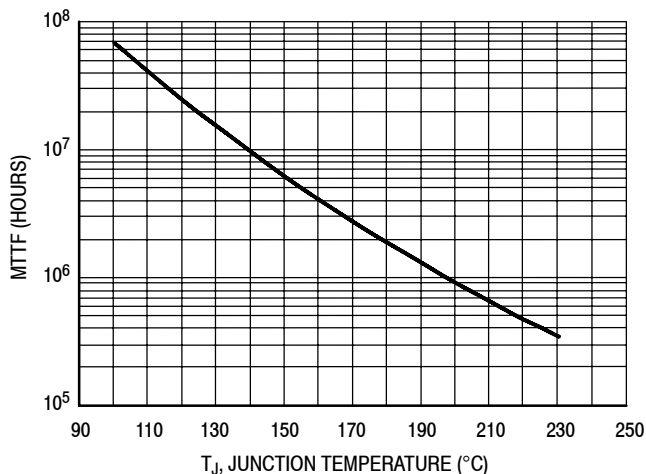
### TYPICAL CHARACTERISTICS



**Figure 13. Pulsed Power Gain, Drain Efficiency and IRL versus Frequency**



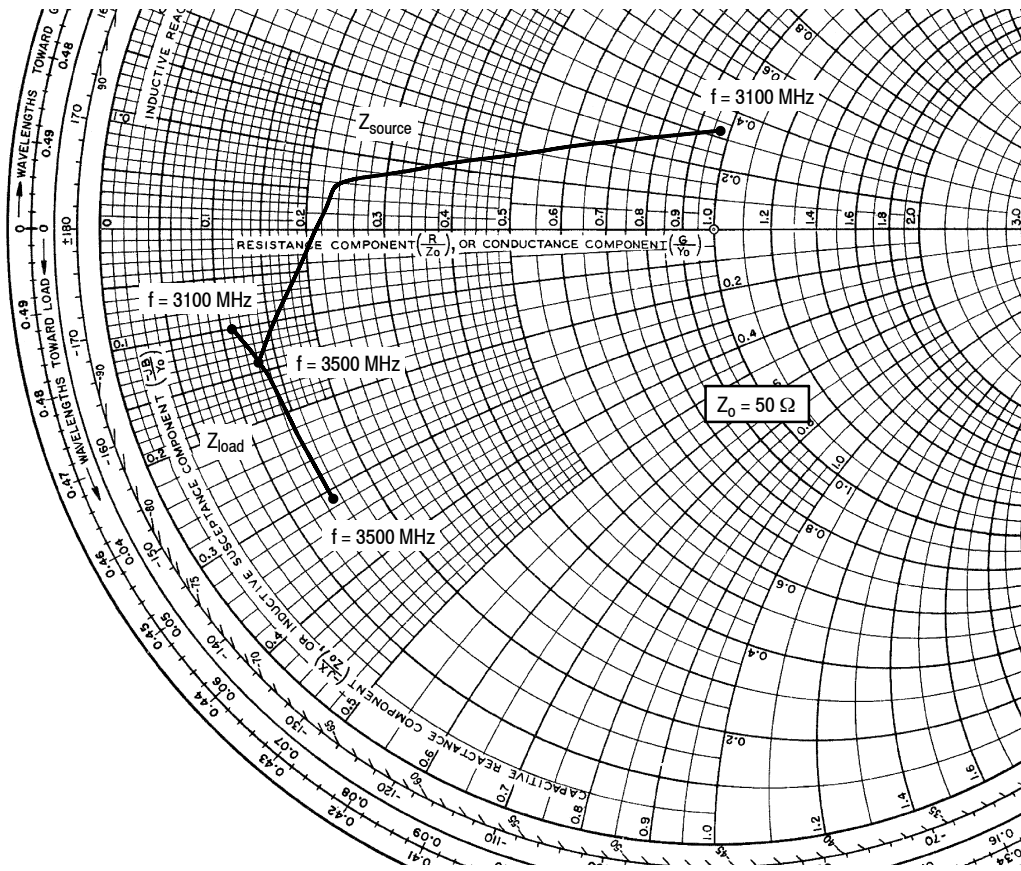
**Figure 14. Single-Channel OFDM Relative Constellation Error, Drain Efficiency and Gain versus Output Power**



This above graph displays calculated MTTF in hours when the device is operated at  $V_{DD} = 32$  Vdc,  $P_{out} = 15$  W Peak, Pulse Width = 100  $\mu$ sec, Duty Cycle = 20%, and  $\eta_D = 41\%$ .

MTTF calculator available at <http://www.freescale.com/rf>. Select Software & Tools/Development Tools/Calculators to access MTTF calculators by product.

**Figure 15. MTTF versus Junction Temperature**



$V_{DD} = 32 \text{ Vdc}$ ,  $I_{DQ} = 50 \text{ mA}$ ,  $P_{out} = 15 \text{ W Peak}$

f MHz	$Z_{source}$ $\Omega$	$Z_{load}$ $\Omega$
3100	$48.6 + j16.1$	$5.6 - j5.2$
3300	$11.8 + j3.15$	$6.36 - j6.83$
3500	$6.43 - j6.79$	$7.41 - j15.5$

$Z_{source}$  = Test circuit impedance as measured from gate to ground.

$Z_{load}$  = Test circuit impedance as measured from drain to ground.

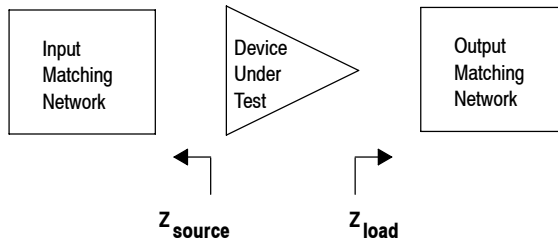
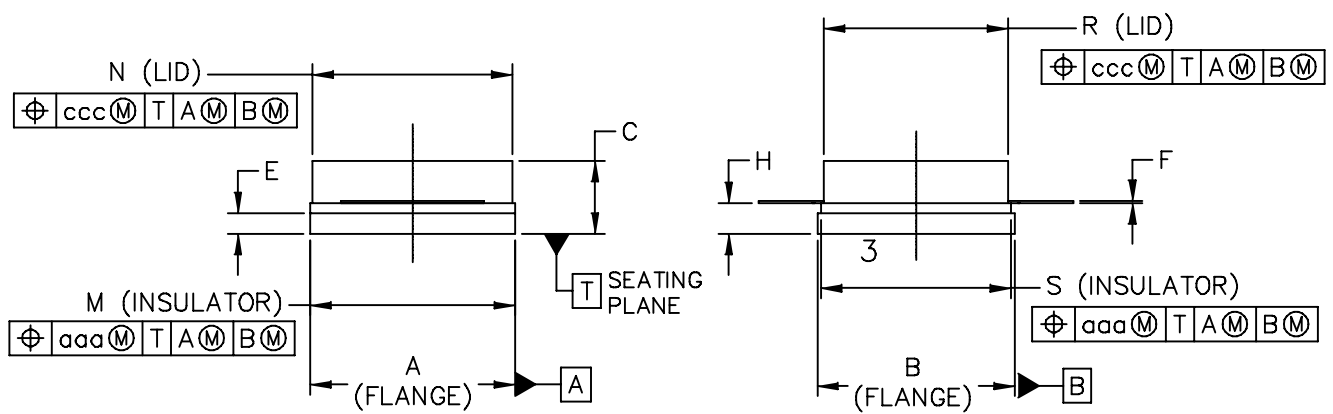
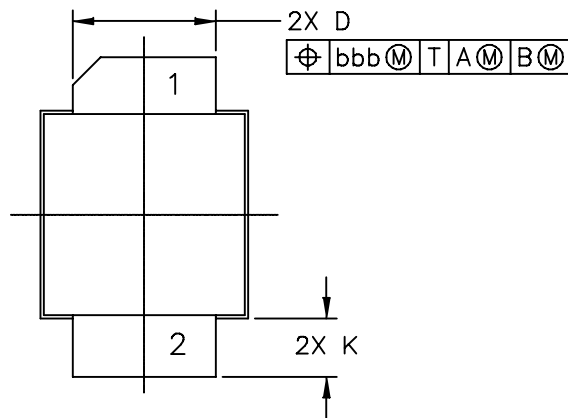


Figure 16. Series Equivalent Source and Load Impedance



### PACKAGE DIMENSIONS



© FREESCALE SEMICONDUCTOR, INC. ALL RIGHTS RESERVED.	MECHANICAL OUTLINE	PRINT VERSION NOT TO SCALE	
TITLE:  NI-400S-240	DOCUMENT NO: 98ASA10732D	REV: A	
	CASE NUMBER: 465J-02	09 MAY 2006	
	STANDARD: NON-JEDEC		

MRF7S35015HSR3

NOTES:

1. CONTROLLING DIMENSION: INCH
2. INTERPRET DIMENSIONS AND TOLERANCES PER ASME Y14.5M-1994.
3. DIMENSION H IS MEASURED .030 (0.762) AWAY FROM PACKAGE BODY

STYLE 1:

- PIN 1 - DRAIN
- 2 - GATE
- 3 - SOURCE

STYLE 2:

- PIN 1 - GATE
- 2 - DRAIN
- 3 - SOURCE

DIM	INCH		MILLIMETER		DIM	INCH		MILLIMETER	
	MIN	MAX	MIN	MAX		MIN	MAX	MIN	MAX
A	.395	.405	10.03	10.29	aaa	.005		0.127	
B	.380	.390	9.65	9.91	bbb	.010		0.254	
C	.125	.163	3.18	4.14	ccc	.015		0.381	
D	.275	.285	6.98	7.24					
E	.035	.045	0.89	1.14					
F	.004	.006	0.10	0.15					
H	.057	.067	1.45	1.70					
K	.0995	.1295	2.53	3.29					
M	.395	.405	10.03	10.29					
N	.385	.395	9.78	10.03					
R	.355	.365	9.02	9.27					
S	.365	.375	9.27	9.53					
© FREESCALE SEMICONDUCTOR, INC. ALL RIGHTS RESERVED.			MECHANICAL OUTLINE			PRINT VERSION NOT TO SCALE			
TITLE:  NI-400S-240					DOCUMENT NO: 98ASA10732D			REV: A	
					CASE NUMBER: 465J-02			09 MAY 2006	
					STANDARD: NON-JEDEC				

## PRODUCT DOCUMENTATION

Refer to the following documents to aid your design process.

### Application Notes

- AN1955: Thermal Measurement Methodology of RF Power Amplifiers

### Engineering Bulletins

- EB212: Using Data Sheet Impedances for RF LDMOS Devices

## REVISION HISTORY

The following table summarizes revisions to this document.

Revision	Date	Description
0	June 2008	• Initial Release of Data Sheet
1	Aug. 2008	• Added p. 1 of Case 465J-02 Mechanical Outline drawing, p. 9
2	Apr. 2011	• Fig. 1, Test Circuit Schematic, Z-list, changed Z7 from 0.084" x 0.73" Microstrip to 0.322" x 0.073" Microstrip and moved footnote reference from Z2 and Z3 to Z15 and Z17, p. 3

## **How to Reach Us:**

### **Home Page:**

[www.freescale.com](http://www.freescale.com)

### **Web Support:**

<http://www.freescale.com/support>

### **USA/Europe or Locations Not Listed:**

Freescale Semiconductor, Inc.  
Technical Information Center, EL516  
2100 East Elliot Road  
Tempe, Arizona 85284  
1-800-521-6274 or +1-480-768-2130  
[www.freescale.com/support](http://www.freescale.com/support)

### **Europe, Middle East, and Africa:**

Freescale Halbleiter Deutschland GmbH  
Technical Information Center  
Schatzbogen 7  
81829 Muenchen, Germany  
+44 1296 380 456 (English)  
+46 8 52200080 (English)  
+49 89 92103 559 (German)  
+33 1 69 35 48 48 (French)  
[www.freescale.com/support](http://www.freescale.com/support)

### **Japan:**

Freescale Semiconductor Japan Ltd.  
Headquarters  
ARCO Tower 15F  
1-8-1, Shimo-Meguro, Meguro-ku,  
Tokyo 153-0064  
Japan  
0120 191014 or +81 3 5437 9125  
[support.japan@freescale.com](mailto:support.japan@freescale.com)

### **Asia/Pacific:**

Freescale Semiconductor China Ltd.  
Exchange Building 23F  
No. 118 Jianguo Road  
Chaoyang District  
Beijing 100022  
China  
+86 10 5879 8000  
[support.asia@freescale.com](mailto:support.asia@freescale.com)

### **For Literature Requests Only:**

Freescale Semiconductor Literature Distribution Center  
1-800-441-2447 or +1-303-675-2140  
Fax: +1-303-675-2150  
[LDCForFreescaleSemiconductor@hibbertgroup.com](mailto:LDCForFreescaleSemiconductor@hibbertgroup.com)

Information in this document is provided solely to enable system and software implementers to use Freescale Semiconductor products. There are no express or implied copyright licenses granted hereunder to design or fabricate any integrated circuits or integrated circuits based on the information in this document.

Freescale Semiconductor reserves the right to make changes without further notice to any products herein. Freescale Semiconductor makes no warranty, representation or guarantee regarding the suitability of its products for any particular purpose, nor does Freescale Semiconductor assume any liability arising out of the application or use of any product or circuit, and specifically disclaims any and all liability, including without limitation consequential or incidental damages. "Typical" parameters that may be provided in Freescale Semiconductor data sheets and/or specifications can and do vary in different applications and actual performance may vary over time. All operating parameters, including "Typicals", must be validated for each customer application by customer's technical experts. Freescale Semiconductor does not convey any license under its patent rights nor the rights of others. Freescale Semiconductor products are not designed, intended, or authorized for use as components in systems intended for surgical implant into the body, or other applications intended to support or sustain life, or for any other application in which the failure of the Freescale Semiconductor product could create a situation where personal injury or death may occur. Should Buyer purchase or use Freescale Semiconductor products for any such unintended or unauthorized application, Buyer shall indemnify and hold Freescale Semiconductor and its officers, employees, subsidiaries, affiliates, and distributors harmless against all claims, costs, damages, and expenses, and reasonable attorney fees arising out of, directly or indirectly, any claim of personal injury or death associated with such unintended or unauthorized use, even if such claim alleges that Freescale Semiconductor was negligent regarding the design or manufacture of the part.

Freescale™ and the Freescale logo are trademarks of Freescale Semiconductor, Inc. All other product or service names are the property of their respective owners.

© Freescale Semiconductor, Inc. 2008, 2011. All rights reserved.



# Mouser Electronics

Authorized Distributor

Click to View Pricing, Inventory, Delivery & Lifecycle Information:

[Freescale Semiconductor:](#)

[MRF7S35015HSR5](#)