

GaAs Infrared Emitting Diode in \varnothing 3 mm (T-1) Package

Description

TSUS4400 is an infrared emitting diode in standard GaAs on GaAs technology, molded in a clear, blue tinted plastic package. The device is spectrally matched to silicon photodetectors.

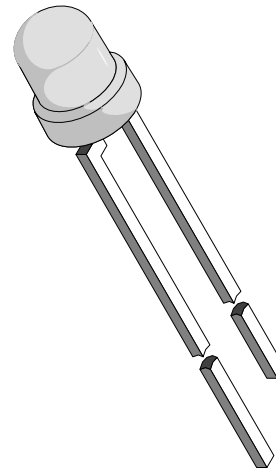

94 8488

Features

- Low forward voltage
- High radiant power and radiant intensity
- Suitable for DC and high pulse current operation
- Standard T-1(\varnothing 3 mm) package
- Angle of half intensity $\varphi = \pm 18^\circ$
- Peak wavelength $\lambda_p = 950$ nm
- High reliability
- Good spectral matching to Si photodetectors

Applications

Infrared remote control systems with small package and low cost requirements in combination with silicon photo detectors. Infrared source in reflective sensors, tape end detection.

Absolute Maximum Ratings

 $T_{amb} = 25^\circ\text{C}$

Parameter	Test Conditions	Symbol	Value	Unit
Reverse Voltage		V_R	5	V
Forward Current		I_F	100	mA
Peak Forward Current	$t_p/T = 0.5, t_p = 100 \mu\text{s}$	I_{FM}	200	mA
Surge Forward Current	$t_p = 100 \mu\text{s}$	I_{FSM}	2	A
Power Dissipation		P_V	170	mW
Junction Temperature		T_j	100	$^\circ\text{C}$
Operating Temperature Range		T_{amb}	-55...+100	$^\circ\text{C}$
Storage Temperature Range		T_{stg}	-55...+100	$^\circ\text{C}$
Soldering Temperature	$t \leq 5\text{sec}, 2 \text{ mm from case}$	T_{sd}	260	$^\circ\text{C}$
Thermal Resistance Junction/Ambient		R_{thJA}	450	K/W

Basic Characteristics

$T_{amb} = 25^{\circ}\text{C}$

Parameter	Test Conditions	Symbol	Min	Typ	Max	Unit
Forward Voltage	$I_F = 100\text{ mA}, t_p = 20\text{ ms}$	V_F		1.3	1.7	V
	$I_F = 1.5\text{ A}, t_p = 100\text{ }\mu\text{s}$	V_F		2.2		V
Temp. Coefficient of V_F	$I_F = 100\text{ mA}$	TK_{V_F}		-1.3		mV/K
Reverse Current	$V_R = 5\text{ V}$	I_R			100	μA
Breakdown Voltage	$I_R = 100\text{ }\mu\text{A}$	$V_{(BR)}$	5	40		V
Junction Capacitance	$V_R = 0\text{ V}, f = 1\text{ MHz}, E = 0$	C_j		30		pF
Radiant Intensity	$I_F = 100\text{ mA}, t_p = 20\text{ ms}$	I_e	7	15		mW/sr
	$I_F = 1.5\text{ A}, t_p = 100\text{ }\mu\text{s}$	I_e		140		mW/sr
Radiant Power	$I_F = 100\text{ mA}, t_p = 20\text{ ms}$	ϕ_e		20		mW
Temp. Coefficient of ϕ_e	$I_F = 20\text{ mA}$	TK_{ϕ_e}		-0.8		%/K
Angle of Half Intensity		φ		± 18		deg
Peak Wavelength	$I_F = 100\text{ mA}$	λ_p		950		nm
Spectral Bandwidth	$I_F = 100\text{ mA}$	$\Delta\lambda$		50		nm
Temp. Coefficient of λ_p	$I_F = 100\text{ mA}$	TK_{λ_p}		0.2		nm/K
Rise Time	$I_F = 100\text{ mA}$	t_r		800		ns
	$I_F = 1.5\text{ A}$	t_r		400		ns
Fall Time	$I_F = 100\text{ mA}$	t_f		800		ns
	$I_F = 1.5\text{ A}$	t_f		400		ns

Typical Characteristics ($T_{amb} = 25^{\circ}\text{C}$ unless otherwise specified)

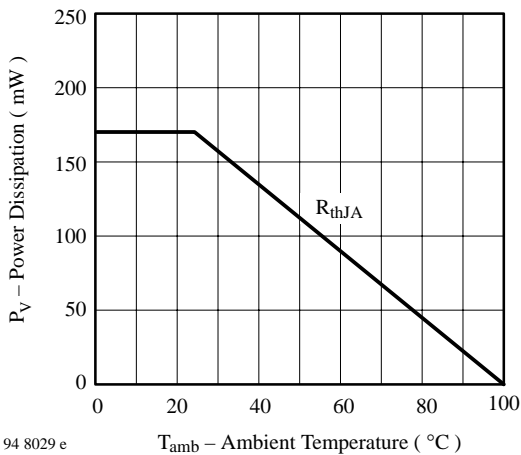

Figure 1. Power Dissipation vs. Ambient Temperature

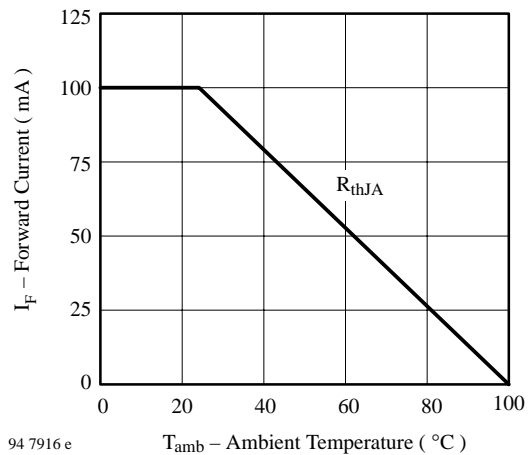
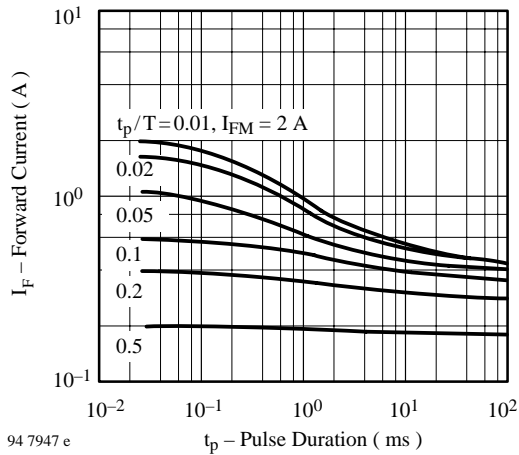
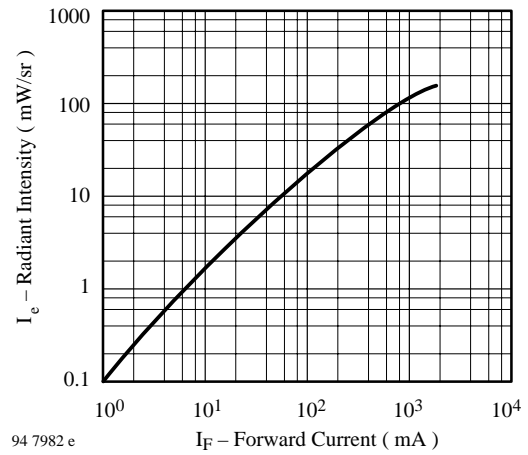

Figure 2. Forward Current vs. Ambient Temperature



94 7947 e

Figure 3. Pulse Forward Current vs. Pulse Duration



94 7982 e

Figure 6. Radiant Intensity vs. Forward Current

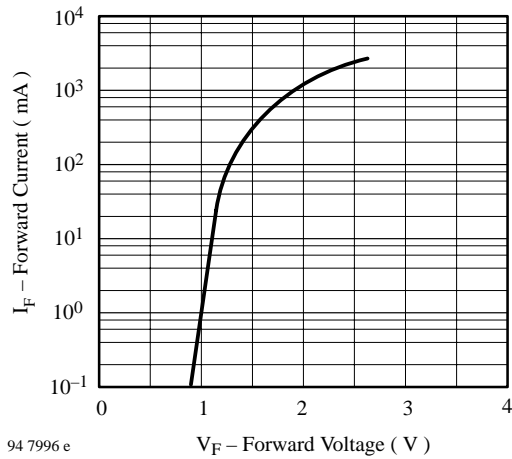

94 7996 e

Figure 4. Forward Current vs. Forward Voltage

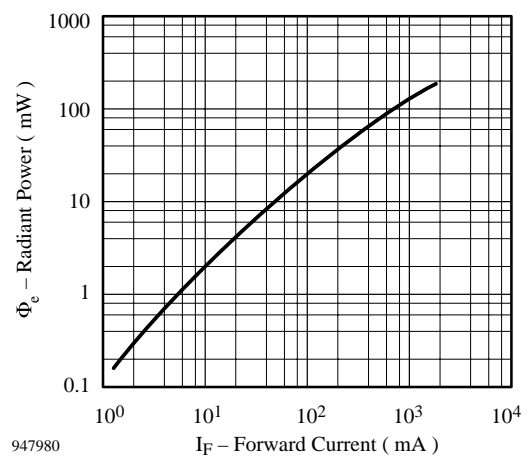

947980

Figure 7. Radiant Power vs. Forward Current

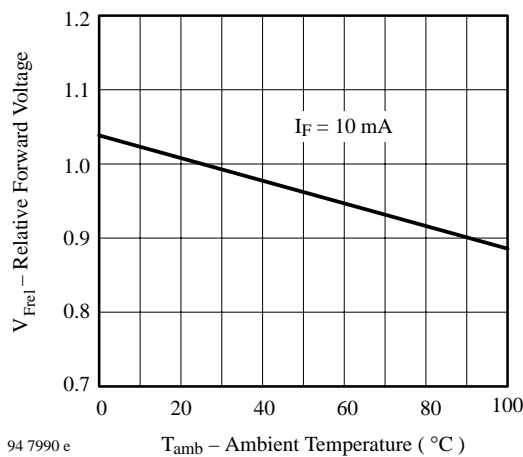

94 7990 e

Figure 5. Relative Forward Voltage vs. Ambient Temperature

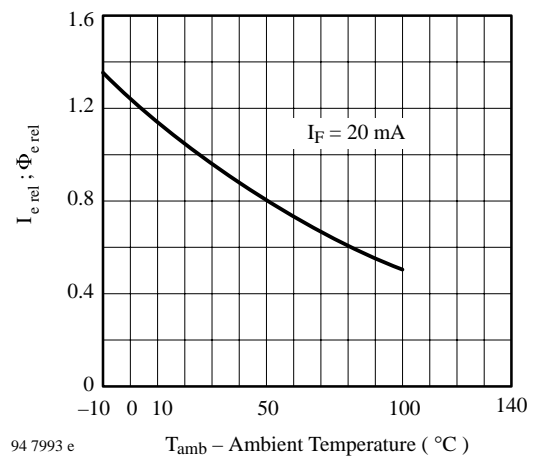

94 7993 e

Figure 8. Rel. Radiant Intensity/Power vs. Ambient Temperature

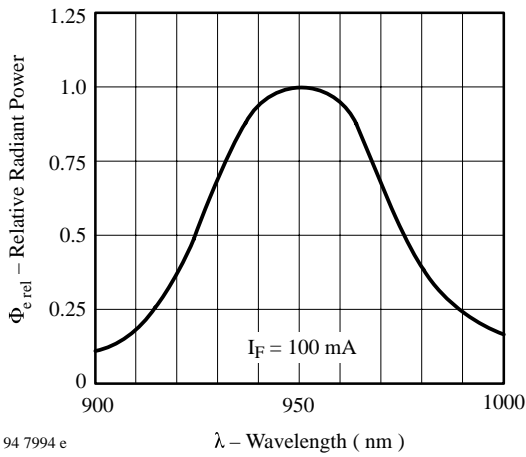

Figure 9. Relative Radiant Power vs. Wavelength

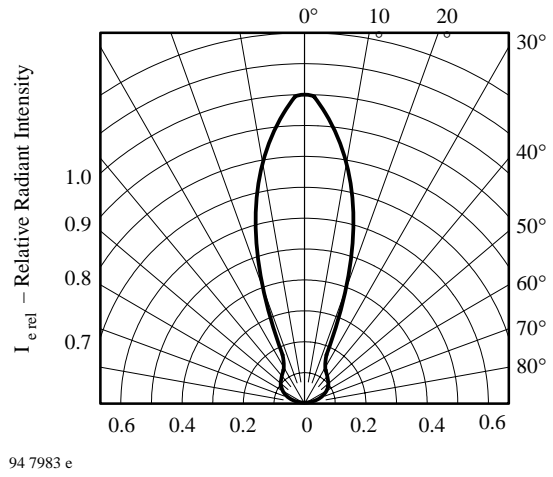
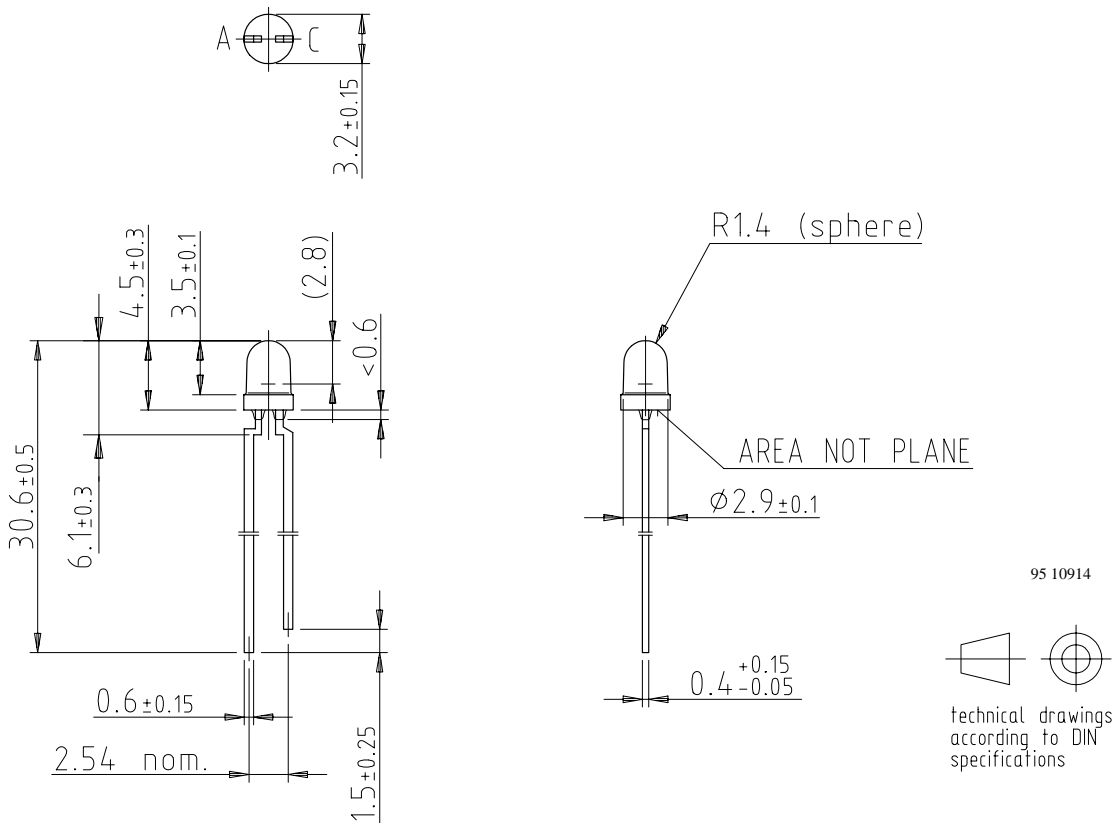

Figure 10. Relative Radiant Intensity vs. Angular Displacement

Dimensions in mm





Ozone Depleting Substances Policy Statement

It is the policy of **Vishay Semiconductor GmbH** to

1. Meet all present and future national and international statutory requirements.
2. Regularly and continuously improve the performance of our products, processes, distribution and operating systems with respect to their impact on the health and safety of our employees and the public, as well as their impact on the environment.

It is particular concern to control or eliminate releases of those substances into the atmosphere which are known as ozone depleting substances (ODSs).

The Montreal Protocol (1987) and its London Amendments (1990) intend to severely restrict the use of ODSs and forbid their use within the next ten years. Various national and international initiatives are pressing for an earlier ban on these substances.

Vishay Semiconductor GmbH has been able to use its policy of continuous improvements to eliminate the use of ODSs listed in the following documents.

1. Annex A, B and list of transitional substances of the Montreal Protocol and the London Amendments respectively
2. Class I and II ozone depleting substances in the Clean Air Act Amendments of 1990 by the Environmental Protection Agency (EPA) in the USA
3. Council Decision 88/540/EEC and 91/690/EEC Annex A, B and C (transitional substances) respectively.

Vishay Semiconductor GmbH can certify that our semiconductors are not manufactured with ozone depleting substances and do not contain such substances.

We reserve the right to make changes to improve technical design and may do so without further notice.

Parameters can vary in different applications. All operating parameters must be validated for each customer application by the customer. Should the buyer use Vishay-Telefunken products for any unintended or unauthorized application, the buyer shall indemnify Vishay-Telefunken against all claims, costs, damages, and expenses, arising out of, directly or indirectly, any claim of personal damage, injury or death associated with such unintended or unauthorized use.

Vishay Semiconductor GmbH, P.O.B. 3535, D-74025 Heilbronn, Germany
Telephone: 49 (0)7131 67 2831, Fax number: 49 (0)7131 67 2423