

## High-Speed N-Channel Power MOSFET

### Features:

- Low Drain-to-Source On Resistance ( $R_{DS(ON)}$ )
- Low Total Gate Charge ( $Q_G$ ) and Gate-to-Drain Charge ( $Q_{GD}$ )
- Low Series Gate Resistance ( $R_G$ )
- Fast Switching
- Capable of Short Dead-Time Operation
- RoHS Compliant

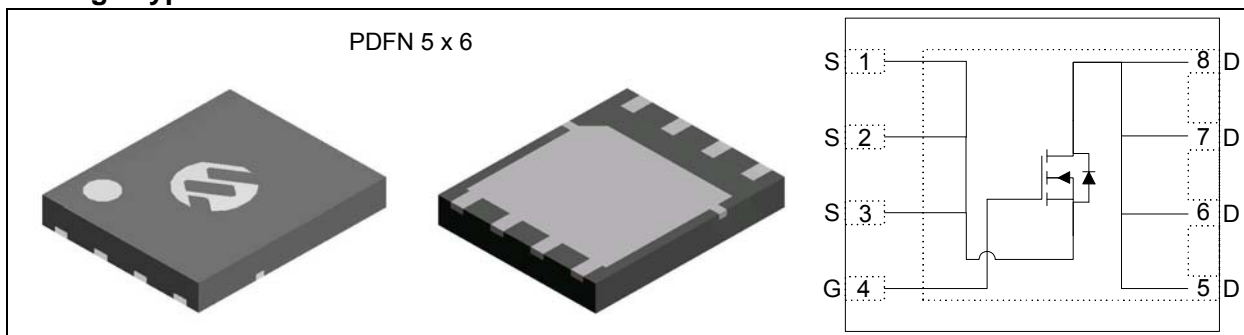
### Description

The MCP87050 is an N-Channel power MOSFET in a popular PDFN 5 mm x 6 mm package. Advanced packaging and silicon processing technologies allow the MCP87050 to achieve a low  $Q_G$  for a given  $R_{DS(ON)}$  value, resulting in a low Figure of Merit (FOM). Combined with low  $R_G$ , the low Figure of Merit of the MCP87050 allows high efficiency power conversion with reduced switching and conduction losses.

### Applications

- Point-of-Load DC-DC Converters
- High Efficiency Power Management in Servers, Networking, and Automotive Applications

### Package Type



**Product Summary Table:** Unless otherwise indicated,  $T_A = +25^\circ\text{C}$

Parameters	Sym	Min	Typ	Max	Units	Conditions
<b>Operating Characteristics</b>						
Drain-to-Source Breakdown Voltage	$BV_{DSS}$	25	—	—	V	$V_{GS} = 0V, I_D = 250 \mu A$
Gate-to-Source Threshold Voltage	$V_{GS(TH)}$	1	1.3	1.6	V	$V_{DS} = V_{GS}, I_D = 250 \mu A$
Drain-to-Source On Resistance	$R_{DS(ON)}$	—	5.0	6.0	m $\Omega$	$V_{GS} = 4.5V, I_D = 20A$
		—	4.2	5.0	m $\Omega$	$V_{GS} = 10V, I_D = 20A$
Total Gate Charge	$Q_G$	—	12.5	15	nC	$V_{DS} = 12.5V, I_D = 20A, V_{GS} = 4.5V$
Gate-to-Drain Charge	$Q_{GD}$	—	4.7	—	nC	$V_{DS} = 12.5V, I_D = 20A$
Series Gate Resistance	$R_G$	—	1.1	—	$\Omega$	
<b>Thermal Characteristics</b>						
Thermal Resistance Junction-to-X	$R_{\theta JX}$	—	—	56	$^\circ\text{C/W}$	<a href="#">Note 1</a>
Thermal Resistance Junction-to-Case	$R_{\theta JC}$	—	—	1.9	$^\circ\text{C/W}$	<a href="#">Note 2</a>

**Note 1:**  $R_{\theta JX}$  is determined with the device surface mounted on a 4-Layer FR4 PCB, with a 1" x 1" mounting pad of 2 oz. copper. This characteristic is dependent on user's board design.

**Note 2:**  $R_{\theta JC}$  is determined using JEDEC 51-14 Method. This characteristic is determined by design.

# MCP87050

## 1.0 ELECTRICAL CHARACTERISTICS

### Absolute Maximum Ratings †

$V_{DS}$ .....	+25V
$V_{GS}$ .....	+10.0V / -8V
$I_D$ , Continuous .....	100A, $T_C = +25^\circ\text{C}$
$P_D$ .....	2.2W, $T_A = +25^\circ\text{C}$
$T_J$ , $T_{STG}$ .....	-55°C to +150°C
$E_{AS}$ Avalanche Energy .....	162 mJ
$I_D = 18\text{A}$ , $L = 1\text{ mH}$ , $R_G = 25\Omega$	

† **Notice:** Stresses above those listed under “Maximum Ratings” may cause permanent damage to the device. This is a stress rating only and functional operation of the device at those or any other conditions above those indicated in the operational sections of this specification is not intended. Exposure to maximum rating conditions for extended periods may affect device reliability.

### DC ELECTRICAL CHARACTERISTICS

Electrical Characteristics: Unless otherwise indicated, $T_A = +25^\circ\text{C}$						
Parameters	Sym	Min	Typ	Max	Units	Conditions
<b>Static Characteristics</b>						
Drain-to-Source Breakdown Voltage	$B_{VDSS}$	25	—	—	V	$V_{GS} = 0\text{V}$ , $I_D = 250\ \mu\text{A}$
Drain-to-Source Leakage Current	$I_{DSS}$	—	—	1	$\mu\text{A}$	$V_{GS} = 0\text{V}$ , $V_{DS} = 20\text{V}$
Gate-to-Source Leakage Current	$I_{GSS}$	—	—	100	nA	$V_{DS} = 0\text{V}$ , $V_{GS} = 10\text{V}/-8\text{V}$
Gate-to-Source Threshold Voltage	$V_{GS(TH)}$	1	1.3	1.6	V	$V_{DS} = V_{GS}$ , $I_D = 250\ \mu\text{A}$
Drain-to-Source On Resistance	$R_{DS(ON)}$	—	5	6.0	$\text{m}\Omega$	$V_{GS} = 4.5\text{V}$ , $I_D = 20\text{A}$
		—	4.2	5	$\text{m}\Omega$	$V_{GS} = 10\text{V}$ , $I_D = 20\text{A}$
Transconductance	$g_{fs}$	—	101	—	S	$V_{DS} = 12.5\text{V}$ , $I_D = 20\text{A}$
<b>Dynamic Characteristics</b>						
Input Capacitance	$C_{ISS}$	—	1040	—	pF	$V_{GS} = 0\text{V}$ , $V_{DS} = 12.5\text{V}$ , $f = 1\text{ MHz}$
Output Capacitance	$C_{OSS}$	—	490	—	pF	$V_{GS} = 0\text{V}$ , $V_{DS} = 12.5\text{V}$ , $f = 1\text{ MHz}$
Reverse Transfer Capacitance	$C_{RSS}$	—	140	—	pF	$V_{GS} = 0\text{V}$ , $V_{DS} = 12.5\text{V}$ , $f = 1\text{ MHz}$
Total Gate Charge	$Q_G$	—	12.5	15	nC	$V_{DS} = 12.5\text{V}$ , $I_D = 20\text{A}$ , $V_{GS} = 4.5\text{V}$
Gate-to-Drain Charge	$Q_{GD}$	—	4.7	—	nC	$V_{DS} = 12.5\text{V}$ , $I_D = 20\text{A}$
Gate-to-Source Charge	$Q_{GS}$	—	1.9	—	nC	$V_{DS} = 12.5\text{V}$ , $I_D = 20\text{A}$
Gate Charge at $V_{GS(TH)}$	$Q_{G(TH)}$	—	1.4	—	nC	$V_{DS} = 12.5\text{V}$ , $I_D = 20\text{A}$
Output Charge	$Q_{OSS}$	—	9.5	—	nC	$V_{DS} = 12.5\text{V}$ , $V_{GS} = 0$
Turn-On Delay Time	$t_{d(on)}$	—	5	—	ns	$V_{DS} = 12.5\text{V}$ , $V_{GS} = 4.5\text{V}$ , $I_D = 20\text{A}$ , $R_G = 2\Omega$
Rise Time	$t_r$	—	18	—	ns	$V_{DS} = 12.5\text{V}$ , $V_{GS} = 4.5\text{V}$ , $I_D = 20\text{A}$ , $R_G = 2\Omega$
Turn-Off Delay Time	$t_{d(off)}$	—	11	—	ns	$V_{DS} = 12.5\text{V}$ , $V_{GS} = 4.5\text{V}$ , $I_D = 20\text{A}$ , $R_G = 2\Omega$
Fall Time	$t_f$	—	5	—	ns	$V_{DS} = 12.5\text{V}$ , $V_{GS} = 4.5\text{V}$ , $I_D = 20\text{A}$ , $R_G = 2\Omega$
Series Gate Resistance	$R_G$	—	1.1	—	$\Omega$	

## DC ELECTRICAL CHARACTERISTICS (CONTINUED)

Electrical Characteristics: Unless otherwise indicated, $T_A = +25^\circ\text{C}$						
Parameters	Sym	Min	Typ	Max	Units	Conditions
<b>Diode Characteristics</b>						
Diode Forward Voltage	$V_{FD}$	—	0.8	1	V	$I_S = 20\text{A}$ , $V_{GS} = 0\text{V}$
Reverse Recovery Charge	$Q_{RR}$	—	20	—	nC	$I_S = 20\text{A}$ , $di/dt = 300\text{ A}/\mu\text{s}$
Reverse Recovery Time	$t_{rr}$	—	16	—	ns	$I_S = 20\text{A}$ , $di/dt = 300\text{ A}/\mu\text{s}$
<b>Avalanche Characteristics</b>						
Avalanche Energy	$E_{AS}$	50	—	—	mJ	$I_D = 10\text{A}$ , $L = 1\text{ mH}$ , $R_G = 25\Omega$

## TEMPERATURE CHARACTERISTICS

Electrical Characteristics: Unless otherwise indicated, $T_A = +25^\circ\text{C}$							
Parameters	Sym	Min	Typ	Max	Units	Conditions	
<b>Temperature Ranges</b>							
Operating Junction Temperature Range	$T_J$	-55	—	150	$^\circ\text{C}$		
Storage Temperature Range	$T_A$	-55	—	150	$^\circ\text{C}$		
<b>Package Thermal Resistances</b>							
Thermal Resistance Junction-to-X, 8L 5x6-PDFN	$R_{\theta JX}$	—	—	56	$^\circ\text{C}/\text{W}$	<a href="#">Note 1</a>	
Thermal Resistance Junction-to-Case, 8L 5x6-PDFN	$R_{\theta JC}$	—	—	1.9	$^\circ\text{C}/\text{W}$	<a href="#">Note 2</a>	

**Note 1:**  $R_{\theta JX}$  is determined with the device surface mounted on a 4-Layer FR4 PCB, with a 1" x 1" mounting pad of 2 oz. copper. This characteristic is dependent on user's board design.

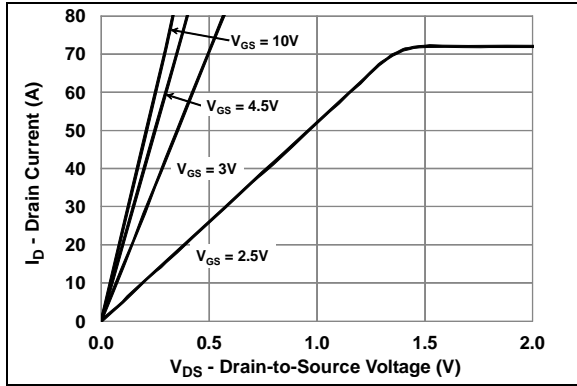
**2:**  $R_{\theta JC}$  is determined using JEDEC 51-14 Method. This characteristic is determined by design.

# MCP87050

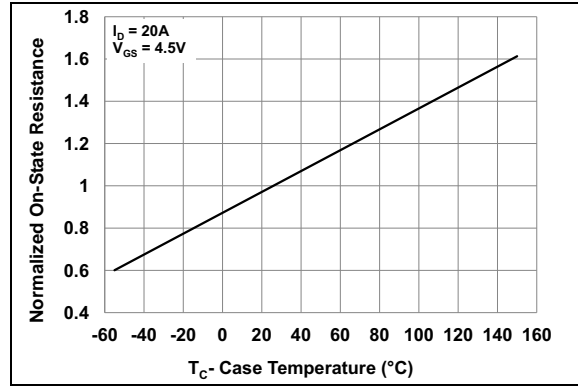
## 2.0 TYPICAL PERFORMANCE CURVES

**Note:** The graphs and tables provided following this note are a statistical summary based on a limited number of samples and are provided for informational purposes only. The performance characteristics listed herein are not tested or guaranteed. In some graphs or tables, the data presented may be outside the specified operating range (e.g., outside specified power supply range) and therefore outside the warranted range.

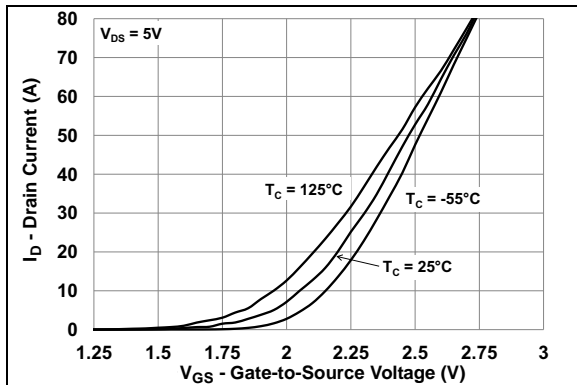
**Note:** Unless otherwise indicated,  $T_A = +25^\circ\text{C}$ .



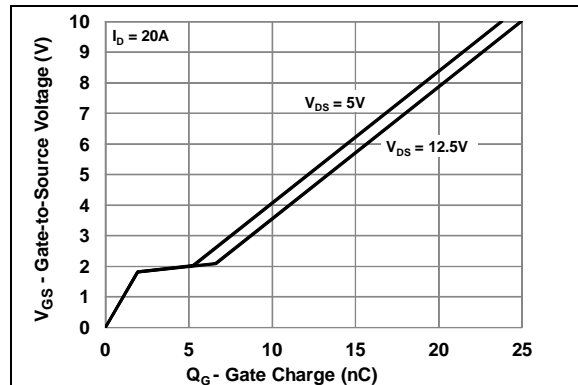
**FIGURE 2-1:** Typical Output Characteristics.



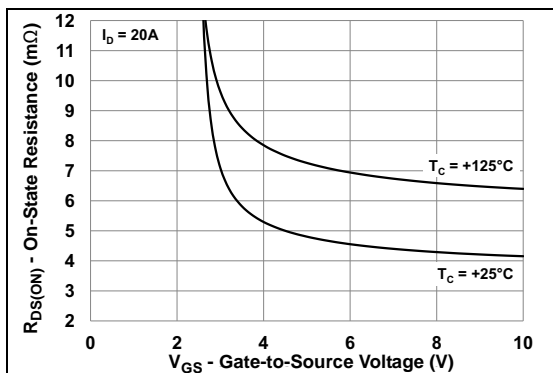
**FIGURE 2-4:** Normalized On Resistance vs. Temperature.



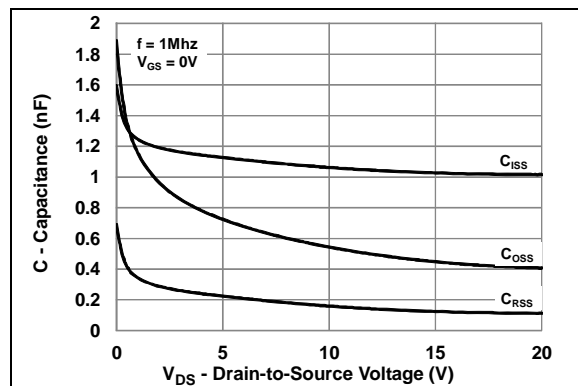
**FIGURE 2-2:** Typical Transfer Characteristics.



**FIGURE 2-5:** Gate-to-Source Voltage vs. Gate Charge.

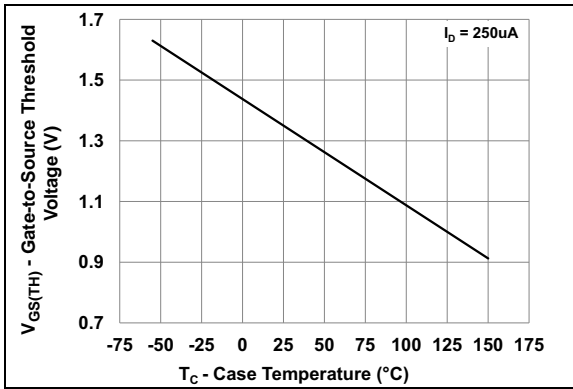


**FIGURE 2-3:** On Resistance vs. Gate-to-Source Voltage.

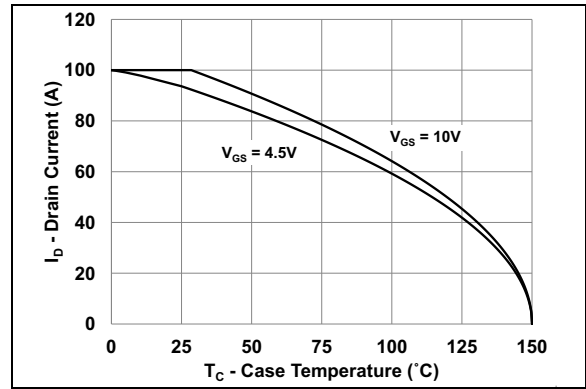


**FIGURE 2-6:** Capacitance vs. Drain-to-Source Voltage.

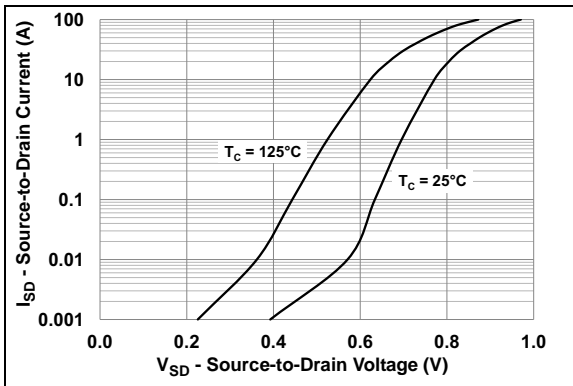
**Note:** Unless otherwise indicated,  $T_A = +25^\circ\text{C}$ .



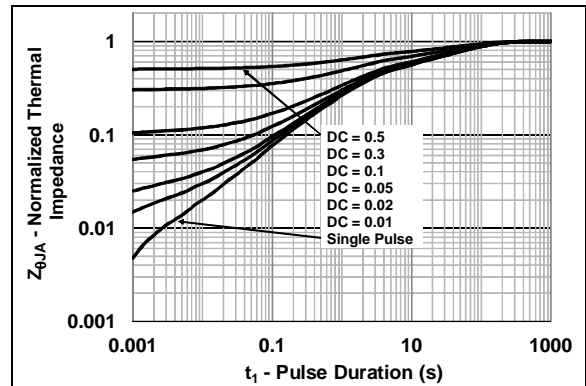
**FIGURE 2-7:** Gate-to-Source Threshold Voltage vs. Temperature.



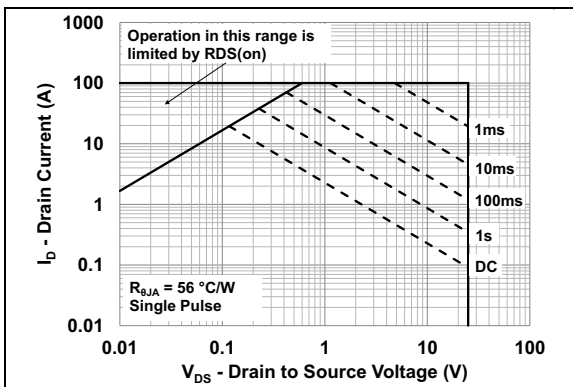
**FIGURE 2-10:** Maximum Drain Current vs. Temperature.



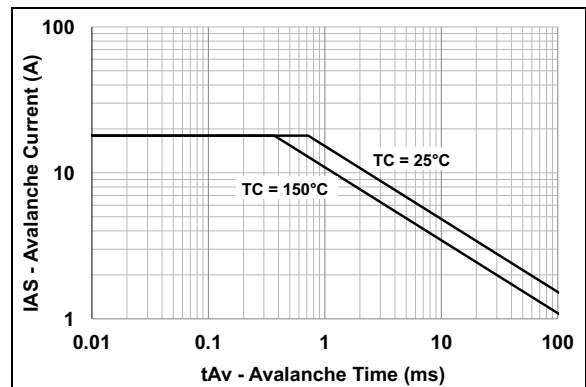
**FIGURE 2-8:** Source-to-Drain Current vs. Source-to-Drain Voltage.



**FIGURE 2-11:** Transient Thermal Impedance.



**FIGURE 2-9:** Maximum Safe Operating Area.

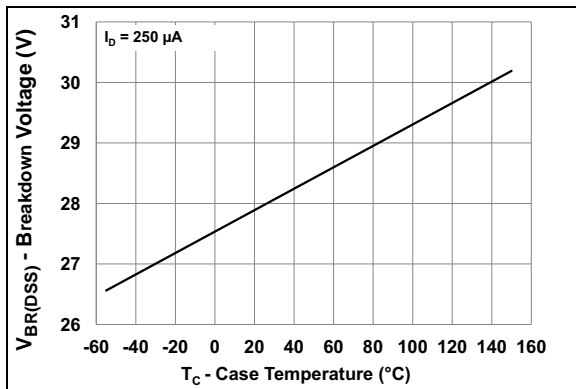


**FIGURE 2-12:** Single-Pulse Unclamped Inductive Switching.

# MCP87050

---

Note: Unless otherwise indicated,  $T_A = +25^\circ\text{C}$ .



**FIGURE 2-13:** *Drain-to-Source Breakdown Voltage vs. Temperature.*

## 3.0 PIN DESCRIPTIONS

The descriptions of the pins are listed in [Table 3-1](#).

**TABLE 3-1: PINOUT DESCRIPTION FOR THE MCP87050**

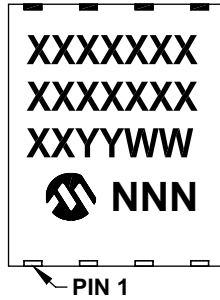
MCP87050	Pin Type	Function
5x6 PDFN		
1, 2, 3	S	Source pin
4	G	Gate pin
5, 6, 7, 8	D	Drain pin, including exposed thermal pad

# MCP87050

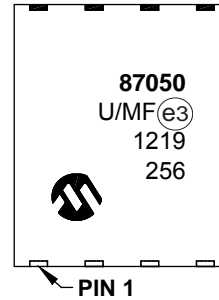
## 4.0 PACKAGING INFORMATION

### 4.1 Package Marking Information\*

8-Lead PDFN (5x6x1.0 mm)



Example



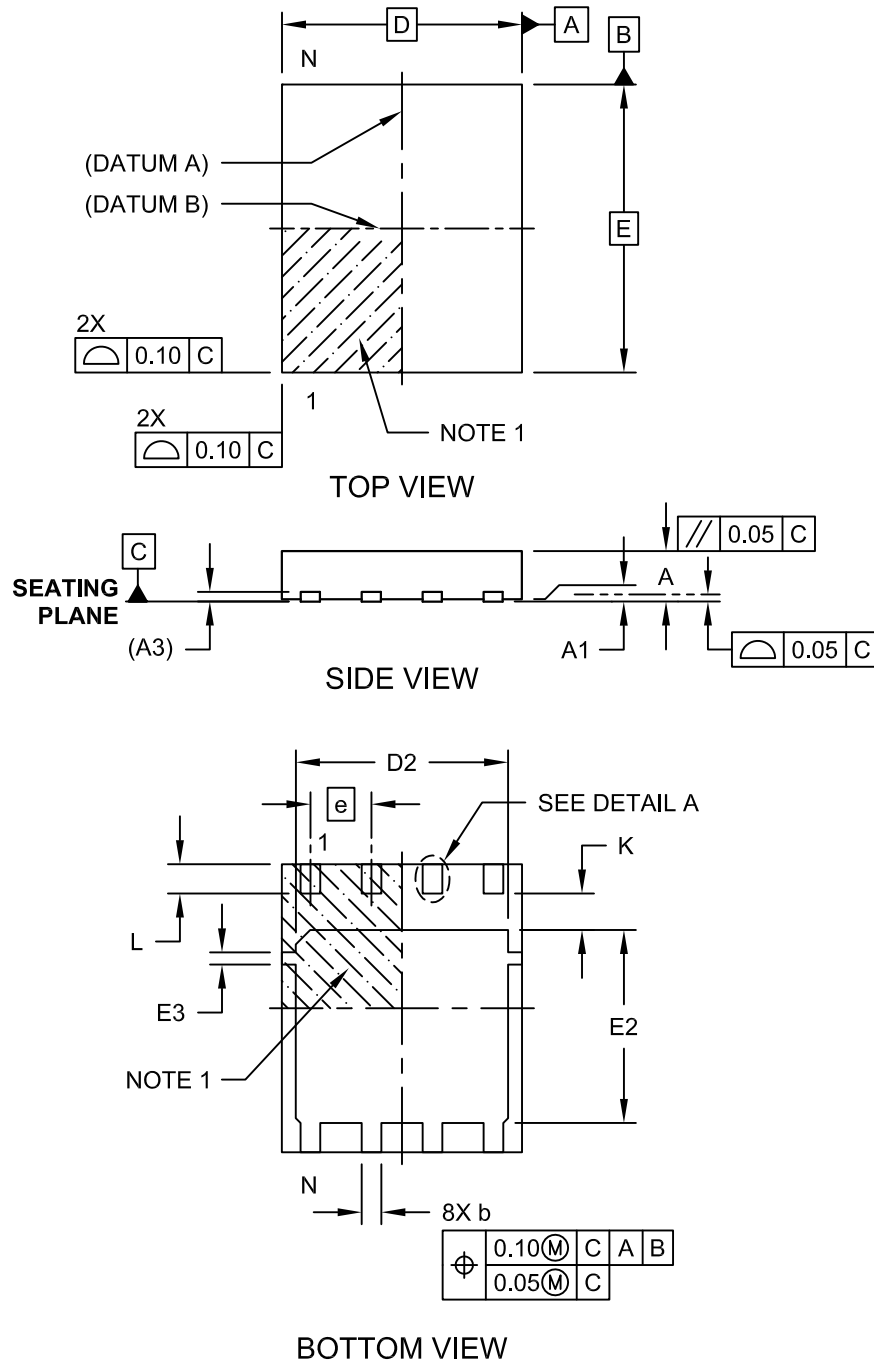
\*RoHS compliant using EU-RoHS exemption: 7(a) - Lead in high-melting-temperature-type solders (i.e. lead-based alloys containing 85% by weight or more lead) can be found on the outer packaging for this package.

<b>Legend:</b>	XX...X	Customer-specific information
	Y	Year code (last digit of calendar year)
	YY	Year code (last 2 digits of calendar year)
	WW	Week code (week of January 1 is week '01')
	NNN	Alphanumeric traceability code
	(e3)	Pb-free JEDEC designator for Matte Tin (Sn)
	*	This package is Pb-free. The Pb-free JEDEC designator ((e3)) can be found on the outer packaging for this package.
<b>Note:</b>	In the event the full Microchip part number cannot be marked on one line, it will be carried over to the next line, thus limiting the number of available characters for customer-specific information.	



## 8-Lead Power Dual Flatpack No Lead Package (MF) – 5x6x1.0 mm Body [PDFN]

**Note:** For the most current package drawings, please see the Microchip Packaging Specification located at <http://www.microchip.com/packaging>

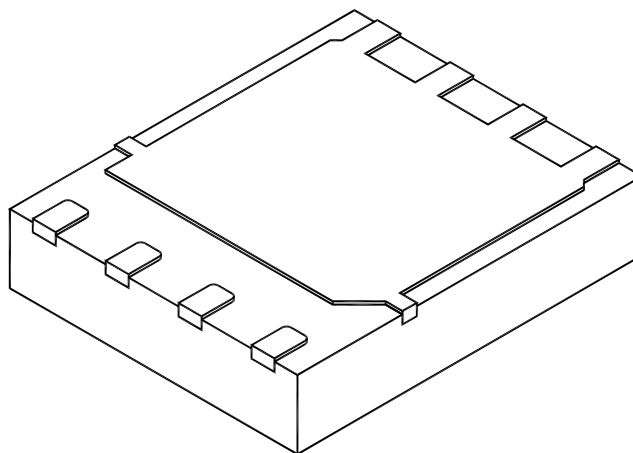


Microchip Technology Drawing C04-188B Sheet 1 of 2

# MCP87050

## 8-Lead Power Dual Flatpack No Lead Package (MF) – 5x6x1.0 mm Body [PDFN]

**Note:** For the most current package drawings, please see the Microchip Packaging Specification located at <http://www.microchip.com/packageing>



### DETAIL A

ALTERNATE  
CONTACT  
SHAPES

Dimension	Units Limits	MILLIMETERS		
		MIN	NOM	MAX
Number of Pins	N	8		
Pitch	e	1.27 BSC		
Overall Height	A	0.80	1.00	1.03
Standoff	A1	0.00	-	0.05
Terminal Thickness	(A3)	0.20 REF		
Overall Length	D	5.00 BSC		
Overall Width	E	6.00 BSC		
Exposed Pad length	D2	4.27	4.42	4.52
Exposed Pad Width	E2	3.87	4.02	4.12
Tab Width	E3	0.20	0.25	0.30
Terminal Width	b	0.36	0.41	0.46
Terminal Length	L	0.51	0.61	0.71
Terminal to Exposed Pad	K	0.71	0.76	0.81

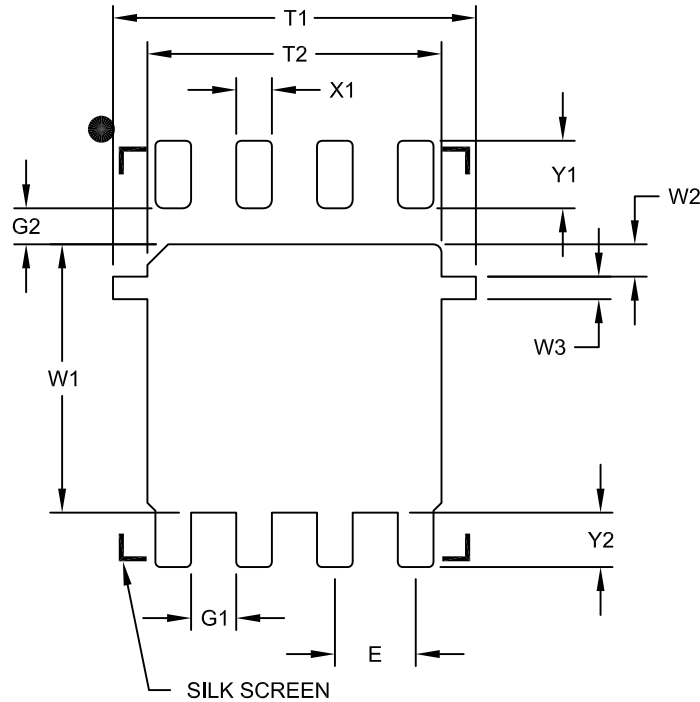
#### Notes:

1. Pin 1 visual index feature may vary, but must be located within the hatched area.
2. Package is saw singulated.
3. Package dimension does not include mold flash, protrusions, burrs or metal smearing.
4. Dimensioning and tolerancing per ASME Y14.5M.  
BSC: Basic Dimension. Theoretically exact value shown without tolerances.  
REF: Reference Dimension, usually without tolerance, for information purposes only.

Microchip Technology Drawing C04-188B Sheet 2 of 2

## 8-Lead Power Dual Flatpack No Lead Package (MF) – 5x6x1.0 mm Body [PDFN]

**Note:** For the most current package drawings, please see the Microchip Packaging Specification located at <http://www.microchip.com/packageing>



### RECOMMENDED LAND PATTERN

Dimension Limits	Units	MILLIMETERS		
		MIN	NOM	MAX
Contact Pitch	E	1.27 BSC		
Center Pad Width	W1			4.22
Pad Edge to Tab	W2		0.51	
Tab Width	W3		0.35	
Center Pad Length With Tabs	T1			5.70
Center Pad Length	T2			4.62
Distance Between Terminals	G1	0.71		
Terminal To Center Pad (X4)	G2	0.57		
Terminal Pad Width (X8)	X1			0.56
Terminal Pad Length (X4)	Y1			1.06
Terminal Pad Length (X8)	Y2			0.86

**Notes:**

1. Dimensioning and tolerancing per ASME Y14.5M

BSC: Basic Dimension. Theoretically exact value shown without tolerances.

Microchip Technology Drawing No. C04-2188A

# MCP87050

---

NOTES:

## APPENDIX A: REVISION HISTORY

### Revision B (November 2012)

- Updated the  $Q_{GD}$  value in the [Product Summary](#) table and the [DC Electrical Characteristics](#) table.
- Updated the Thermal Resistance Junction-to-Case value in the [Temperature Characteristics](#) table.
- Replaced [Figure 2-10](#) and [Figure 2-13](#).

### Revision A (September 2012)

- Original Release of this Document.

## PRODUCT IDENTIFICATION SYSTEM

To order or obtain information, e.g., on pricing or delivery, refer to the factory or the listed sales office.

<u>PART NO.</u>	<u>X</u>	<u>/XX</u>
Device	Temperature Range	Package
<b>Device:</b>	MCP87050T:	N-Channel power MOSFET (Tape and Reel) (PDFN)
<b>Temperature Range:</b>	U	= -55°C to +150°C (Ultra High)
<b>Package:</b>	MF	= Plastic Dual Flat, No Lead Package (5x6x1.0 mm Body) (PDFN), 8-lead

**Example:**  
a) MCP87050T-U/MF: Tape and Reel, Extended Temperature, 8LD PDFN package

---

**Note the following details of the code protection feature on Microchip devices:**

- Microchip products meet the specification contained in their particular Microchip Data Sheet.
- Microchip believes that its family of products is one of the most secure families of its kind on the market today, when used in the intended manner and under normal conditions.
- There are dishonest and possibly illegal methods used to breach the code protection feature. All of these methods, to our knowledge, require using the Microchip products in a manner outside the operating specifications contained in Microchip's Data Sheets. Most likely, the person doing so is engaged in theft of intellectual property.
- Microchip is willing to work with the customer who is concerned about the integrity of their code.
- Neither Microchip nor any other semiconductor manufacturer can guarantee the security of their code. Code protection does not mean that we are guaranteeing the product as “unbreakable.”

Code protection is constantly evolving. We at Microchip are committed to continuously improving the code protection features of our products. Attempts to break Microchip's code protection feature may be a violation of the Digital Millennium Copyright Act. If such acts allow unauthorized access to your software or other copyrighted work, you may have a right to sue for relief under that Act.

---

Information contained in this publication regarding device applications and the like is provided only for your convenience and may be superseded by updates. It is your responsibility to ensure that your application meets with your specifications. MICROCHIP MAKES NO REPRESENTATIONS OR WARRANTIES OF ANY KIND WHETHER EXPRESS OR IMPLIED, WRITTEN OR ORAL, STATUTORY OR OTHERWISE, RELATED TO THE INFORMATION, INCLUDING BUT NOT LIMITED TO ITS CONDITION, QUALITY, PERFORMANCE, MERCHANTABILITY OR FITNESS FOR PURPOSE. Microchip disclaims all liability arising from this information and its use. Use of Microchip devices in life support and/or safety applications is entirely at the buyer's risk, and the buyer agrees to defend, indemnify and hold harmless Microchip from any and all damages, claims, suits, or expenses resulting from such use. No licenses are conveyed, implicitly or otherwise, under any Microchip intellectual property rights.

#### **Trademarks**

The Microchip name and logo, the Microchip logo, dsPIC, FlashFlex, KEELOQ, KEELOQ logo, MPLAB, PIC, PICmicro, PICSTART, PIC<sup>32</sup> logo, rPIC, SST, SST Logo, SuperFlash and UNI/O are registered trademarks of Microchip Technology Incorporated in the U.S.A. and other countries.

FilterLab, Hampshire, HI-TECH C, Linear Active Thermistor, MTP, SEEVAL and The Embedded Control Solutions Company are registered trademarks of Microchip Technology Incorporated in the U.S.A.

Silicon Storage Technology is a registered trademark of Microchip Technology Inc. in other countries.

Analog-for-the-Digital Age, Application Maestro, BodyCom, chipKIT, chipKIT logo, CodeGuard, dsPICDEM, dsPICDEM.net, dsPICworks, dsSPEAK, ECAN, ECONOMONITOR, FanSense, HI-TIDE, In-Circuit Serial Programming, ICSP, Mindi, MiWi, MPASM, MPF, MPLAB Certified logo, MPLIB, MPLINK, mTouch, Omniclient Code Generation, PICC, PICC-18, PICDEM, PICDEM.net, PICkit, PICTail, REAL ICE, rFLAB, Select Mode, SQI, Serial Quad I/O, Total Endurance, TSHARC, UniWinDriver, WiperLock, ZENA and Z-Scale are trademarks of Microchip Technology Incorporated in the U.S.A. and other countries.

SQTP is a service mark of Microchip Technology Incorporated in the U.S.A.

GestIC and ULPP are registered trademarks of Microchip Technology Germany II GmbH & Co. & KG, a subsidiary of Microchip Technology Inc., in other countries.

All other trademarks mentioned herein are property of their respective companies.

© 2012, Microchip Technology Incorporated, Printed in the U.S.A., All Rights Reserved.

 Printed on recycled paper.

ISBN: 978-1-62076-665-1

*Microchip received ISO/TS-16949:2009 certification for its worldwide headquarters, design and wafer fabrication facilities in Chandler and Tempe, Arizona; Gresham, Oregon and design centers in California and India. The Company's quality system processes and procedures are for its PIC<sup>®</sup> MCUs and dsPIC<sup>®</sup> DSCs, KEELOQ<sup>®</sup> code hopping devices, Serial EEPROMs, microperipherals, nonvolatile memory and analog products. In addition, Microchip's quality system for the design and manufacture of development systems is ISO 9001:2000 certified.*

---

**QUALITY MANAGEMENT SYSTEM**  
**CERTIFIED BY DNV**  
**== ISO/TS 16949 ==**



# MICROCHIP

## Worldwide Sales and Service

### AMERICAS

**Corporate Office**  
2355 West Chandler Blvd.  
Chandler, AZ 85224-6199  
Tel: 480-792-7200  
Fax: 480-792-7277  
Technical Support:  
<http://www.microchip.com/support>  
Web Address:  
[www.microchip.com](http://www.microchip.com)

**Atlanta**  
Duluth, GA  
Tel: 678-957-9614  
Fax: 678-957-1455

**Boston**  
Westborough, MA  
Tel: 774-760-0087  
Fax: 774-760-0088

**Chicago**  
Itasca, IL  
Tel: 630-285-0071  
Fax: 630-285-0075

**Cleveland**  
Independence, OH  
Tel: 216-447-0464  
Fax: 216-447-0643

**Dallas**  
Addison, TX  
Tel: 972-818-7423  
Fax: 972-818-2924

**Detroit**  
Farmington Hills, MI  
Tel: 248-538-2250  
Fax: 248-538-2260

**Indianapolis**  
Noblesville, IN  
Tel: 317-773-8323  
Fax: 317-773-5453

**Los Angeles**  
Mission Viejo, CA  
Tel: 949-462-9523  
Fax: 949-462-9608

**Santa Clara**  
Santa Clara, CA  
Tel: 408-961-6444  
Fax: 408-961-6445

**Toronto**  
Mississauga, Ontario,  
Canada  
Tel: 905-673-0699  
Fax: 905-673-6509

### ASIA/PACIFIC

**Asia Pacific Office**  
Suites 3707-14, 37th Floor  
Tower 6, The Gateway  
Harbour City, Kowloon  
Hong Kong  
Tel: 852-2401-1200  
Fax: 852-2401-3431

**Australia - Sydney**  
Tel: 61-2-9868-6733  
Fax: 61-2-9868-6755

**China - Beijing**  
Tel: 86-10-8569-7000  
Fax: 86-10-8528-2104

**China - Chengdu**  
Tel: 86-28-8665-5511  
Fax: 86-28-8665-7889

**China - Chongqing**  
Tel: 86-23-8980-9588  
Fax: 86-23-8980-9500

**China - Hangzhou**  
Tel: 86-571-2819-3187  
Fax: 86-571-2819-3189

**China - Hong Kong SAR**  
Tel: 852-2401-1200  
Fax: 852-2401-3431

**China - Nanjing**  
Tel: 86-25-8473-2460  
Fax: 86-25-8473-2470

**China - Qingdao**  
Tel: 86-532-8502-7355  
Fax: 86-532-8502-7205

**China - Shanghai**  
Tel: 86-21-5407-5533  
Fax: 86-21-5407-5066

**China - Shenyang**  
Tel: 86-24-2334-2829  
Fax: 86-24-2334-2393

**China - Shenzhen**  
Tel: 86-755-8203-2660  
Fax: 86-755-8203-1760

**China - Wuhan**  
Tel: 86-27-5980-5300  
Fax: 86-27-5980-5118

**China - Xian**  
Tel: 86-29-8833-7252  
Fax: 86-29-8833-7256

**China - Xiamen**  
Tel: 86-592-2388138  
Fax: 86-592-2388130

**China - Zhuhai**  
Tel: 86-756-3210040  
Fax: 86-756-3210049

### ASIA/PACIFIC

**India - Bangalore**  
Tel: 91-80-3090-4444  
Fax: 91-80-3090-4123

**India - New Delhi**  
Tel: 91-11-4160-8631  
Fax: 91-11-4160-8632

**India - Pune**  
Tel: 91-20-2566-1512  
Fax: 91-20-2566-1513

**Japan - Osaka**  
Tel: 81-66-152-7160  
Fax: 81-66-152-9310

**Japan - Yokohama**  
Tel: 81-45-471-6166  
Fax: 81-45-471-6122

**Korea - Daegu**  
Tel: 82-53-744-4301  
Fax: 82-53-744-4302

**Korea - Seoul**  
Tel: 82-2-554-7200  
Fax: 82-2-558-5932 or  
82-2-558-5934

**Malaysia - Kuala Lumpur**  
Tel: 60-3-6201-9857  
Fax: 60-3-6201-9859

**Malaysia - Penang**  
Tel: 60-4-227-8870  
Fax: 60-4-227-4068

**Philippines - Manila**  
Tel: 63-2-634-9065  
Fax: 63-2-634-9069

**Singapore**  
Tel: 65-6334-8870  
Fax: 65-6334-8850

**Taiwan - Hsin Chu**  
Tel: 886-3-5778-366  
Fax: 886-3-5770-955

**Taiwan - Kaohsiung**  
Tel: 886-7-213-7828  
Fax: 886-7-330-9305

**Taiwan - Taipei**  
Tel: 886-2-2508-8600  
Fax: 886-2-2508-0102

**Thailand - Bangkok**  
Tel: 66-2-694-1351  
Fax: 66-2-694-1350

### EUROPE

**Austria - Wels**  
Tel: 43-7242-2244-39  
Fax: 43-7242-2244-393

**Denmark - Copenhagen**  
Tel: 45-4450-2828  
Fax: 45-4485-2829

**France - Paris**  
Tel: 33-1-69-53-63-20  
Fax: 33-1-69-30-90-79

**Germany - Munich**  
Tel: 49-89-627-144-0  
Fax: 49-89-627-144-44

**Italy - Milan**  
Tel: 39-0331-742611  
Fax: 39-0331-466781

**Netherlands - Drunen**  
Tel: 31-416-690399  
Fax: 31-416-690340

**Spain - Madrid**  
Tel: 34-91-708-08-90  
Fax: 34-91-708-08-91

**UK - Wokingham**  
Tel: 44-118-921-5869  
Fax: 44-118-921-5820

10/26/12



# Mouser Electronics

Authorized Distributor

Click to View Pricing, Inventory, Delivery & Lifecycle Information:

[Microchip:](#)

[MCP87050T-U/MF](#)