

## Features

- Peak pulse power:
  - 400 W (10/1000  $\mu$ s)
  - 2.3 kW (8/20  $\mu$ s)
- Stand-off voltage range: from 5 V to 70 V
- Unidirectional and bidirectional types
- Low leakage current:
  - 0.2  $\mu$ A at 25 °C
  - 1  $\mu$ A at 85 °C
- Operating  $T_{j\max}$ : 150 °C
- High power capability at  $T_{j\max}$ :
  - 270 W (10/1000  $\mu$ s)
- JEDEC registered package outline
- Resin meets UL 94, V0
- AEC-Q101 qualified

## Complies with the following standards

- ISO 10605, C = 150 pF, R = 330  $\Omega$ :
  - 30 kV (air discharge)
  - 30 kV (contact discharge)
- ISO 10605, C = 330 pF, R = 330  $\Omega$ :
  - 30 kV (air discharge)
  - 30 kV (contact discharge)
- ISO 7637-2<sup>(a)</sup>
  - pulse 1:  $V_S = -100$  V
  - pulse 2a:  $V_S = +50$  V
  - pulse 3a:  $V_S = -150$  V
  - pulse 3b:  $V_S = +100$  V

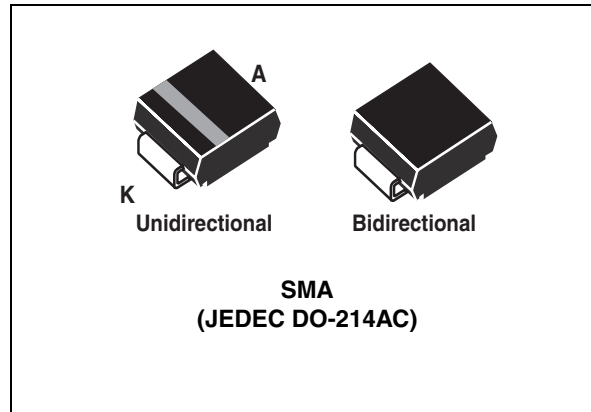

## Description

The SM4TY Transil series has been designed to protect sensitive automotive circuits against surges defined in ISO 7637-2 and against electrostatic discharges according to ISO 10605.

The planar technology makes it compatible with high-end circuits where low leakage current and high junction temperature are required to provide reliability and stability over time. SM4TY devices are packaged in SMA (SMA footprint in accordance with IPC 7531 standard).

a. Not applicable to parts with stand-off voltage lower than the average battery voltage (13.5 V)

**TM:** Transil is a trademark of STMicroelectronics

# 1 Characteristics

**Table 1. Absolute maximum ratings ( $T_{amb} = 25\text{ }^{\circ}\text{C}$ )**

Symbol	Parameter		Value	Unit
$V_{PP}$	Peak pulse voltage	ISO 10605 ( $C = 150\text{ pF}, R = 330\text{ }\Omega$ )		
		Contact discharge	30	kV
		Air discharge	30	
		ISO 10605, $C = 150\text{ pF}, R = 330\text{ }\Omega$ :		
Contact discharge	30			
$P_{PP}$	Peak pulse power dissipation <sup>(1)</sup>	$T_{j\text{ initial}} = T_{amb}$	400	W
$T_{stg}$	Storage temperature range		-65 to + 150	$^{\circ}\text{C}$
$T_j$	Operating junction temperature range		-55 to + 150	$^{\circ}\text{C}$
$T_L$	Maximum lead temperature for soldering during 10 s.		260	$^{\circ}\text{C}$

1. For a surge greater than the maximum values, the diode will fail in short-circuit.

**Figure 1. Electrical characteristics - definitions**

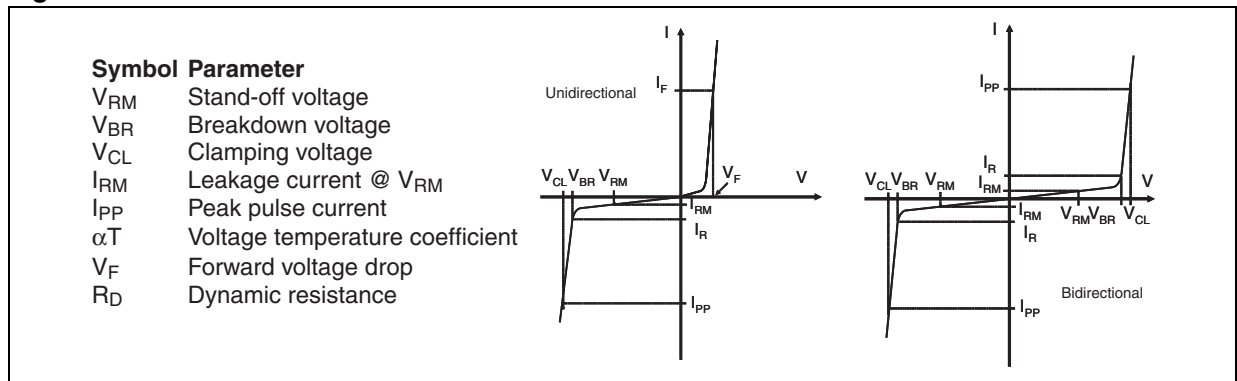

**Figure 2. Pulse definition for electrical characteristics**

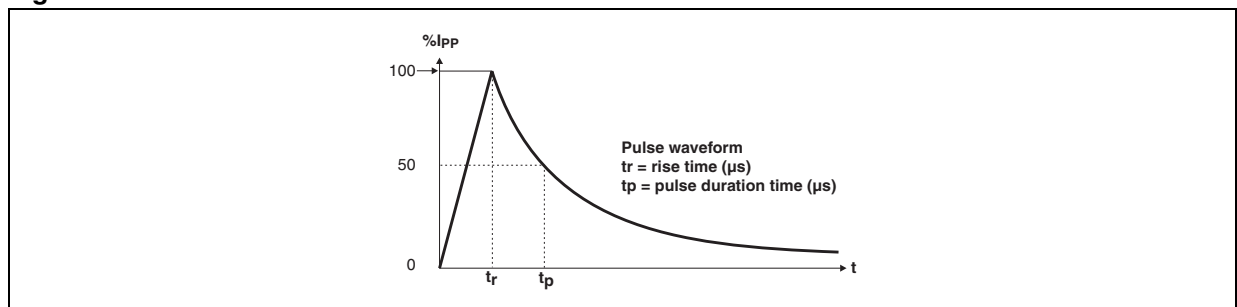

**Table 2. Electrical characteristics, typical values if not otherwise stated (T<sub>amb</sub> = 25 °C)**

Order code	I <sub>RM</sub> max @ V <sub>RM</sub>		V <sub>BR</sub> @ I <sub>R</sub> <sup>(1)</sup>				V <sub>CL</sub> @ I <sub>PP</sub> 10/1000 μs		R <sub>D</sub> 10/1000 μs	V <sub>CL</sub> @ I <sub>PP</sub> 8/20 μs		R <sub>D</sub> 8/20 μs	αT <sup>(2)</sup>	
	25 °C	85 °C	min.	typ.	max.	max.			max.			max		
	μA		V	V			mA	V <sup>(3)</sup>	A <sup>(4)</sup>	Ω	V <sup>(3)</sup>	A <sup>(4)</sup>	Ω	10-4/ °C
SM4T6V7AY/CAY	20	50	5	6.4	6.74	7.1	10	9.2	43.5	0.049	13.4	174	0.036	5.7
SM4T7V6AY/CAY	20	50	6.5	7.2	7.58	8.0	10	11.2	35.7	0.091	14.5	160	0.041	6.1
SM4T10AY/CAY	20	50	8.5	9.4	9.9	10.4	1	14.4	27.7	0.145	19.5	124	0.073	7.3
SM4T12AY/CAY	0.2	1	10	11.1	11.7	12.3	1	17.0	23.5	0.201	21.7	106	0.089	7.8
SM4T14AY/CAY	0.2	1	12	13.3	14.0	14.7	1	19.9	20.1	0.259	25.3	91	0.116	8.3
SM4T15AY/CAY	0.2	1	13	14.4	15.2	16.0	1	21.5	18.6	0.298	27.2	85	0.132	8.4
SM4T18AY/CAY	0.2	1	15	16.7	17.6	18.5	1	24.4	16.4	0.361	32.5	71	0.197	8.8
SM4T21AY/CAY	0.2	1	18	20.0	21.1	22.2	1	29.2	13.7	0.514	39.3	59	0.291	9.2
SM4T23AY/CAY	0.2	1	20	22.2	23.4	24.6	1	32.4	12.3	0.637	42.8	54	0.338	9.4
SM4T26AY/CAY	0.2	1	22	24.4	25.7	27.0	1	35.5	11.2	0.760	48.3	48	0.444	9.6
SM4T28AY/CAY	0.2	1	24	26.7	28.1	29.5	1	38.9	10.3	0.912	50	46	0.446	9.6
SM4T30AY/CAY	0.2	1	26	28.9	30.4	31.9	1	42.1	9.5	1.07	53.5	43	0.502	9.7
SM4T33AY/CAY	0.2	1	28	31.1	32.7	34.3	1	45.4	8.8	1.26	59	39	0.632	9.8
SM4T35AY/CAY	0.2	1	30	33.3	35.1	36.9	1	48.4	8.3	1.39	64.3	36	0.762	9.9
SM4T39AY/CAY	0.2	1	33	36.7	38.6	40.5	1	53.3	7.5	1.70	69.7	33	0.884	10
SM4T47AY/CAY	0.2	1	40	44.4	46.7	49.0	1	64.5	6.2	2.49	84	27	1.30	10.1
SM4T50AY/CAY	0.2	1	43	47.8	50.3	52.8	1	69.4	5.7	2.91	91	25	1.53	10.2
SM4T56AY/CAY	0.2	1	48	53.3	56.1	58.9	1	77.4	5.2	3.56	100	23	1.79	10.3
SM4T68AY/CAY	0.2	1	58	64.4	67.8	71.2	1	93.6	4.3	5.21	121	19	2.62	10.4
SM4T82AY/CAY	0.2	1	70	77.8	81.9	86.0	1	113	3.5	7.72	146	16	3.75	10.5

1. Pulse test: t<sub>p</sub> < 50 ms
2. To calculate maximum clamping voltage at other surge level, use the following formula: V<sub>CL</sub>max = V<sub>CL</sub> - R<sub>D</sub> × (I<sub>PP</sub> - I<sub>PPappli</sub>)  
where I<sub>PPappli</sub> is the surge current in the application
3. To calculate V<sub>BR</sub> or V<sub>CL</sub> versus junction temperature, use the following formulas:  
V<sub>BR</sub> @ T<sub>J</sub> = V<sub>BR</sub> @ 25 °C × (1 + αT × (T<sub>J</sub> - 25))  
V<sub>CL</sub> @ T<sub>J</sub> = V<sub>CL</sub> @ 25 °C × (1 + αT × (T<sub>J</sub> - 25))
4. Surge capability given for both directions for unidirectional and bidirectional types.

Figure 3. Peak pulse power dissipation versus initial junction temperature

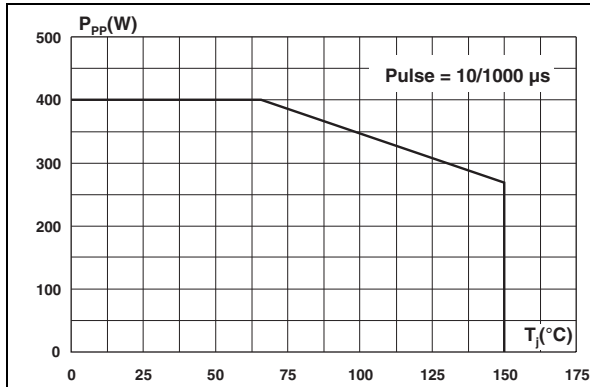

Figure 4. Peak pulse power versus exponential pulse duration ( $T_j$  initial = 25 °C)

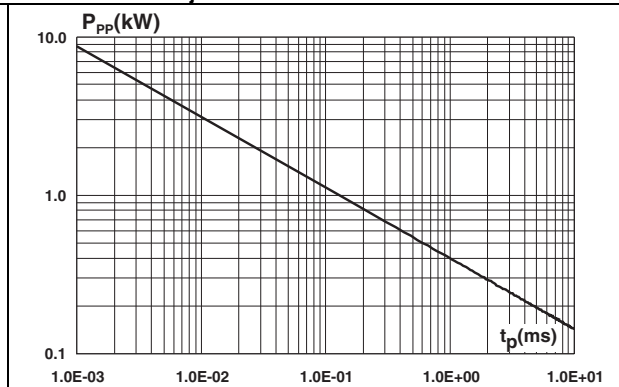

Figure 5. Clamping voltage versus peak pulse current (exponential waveform, maximum values)

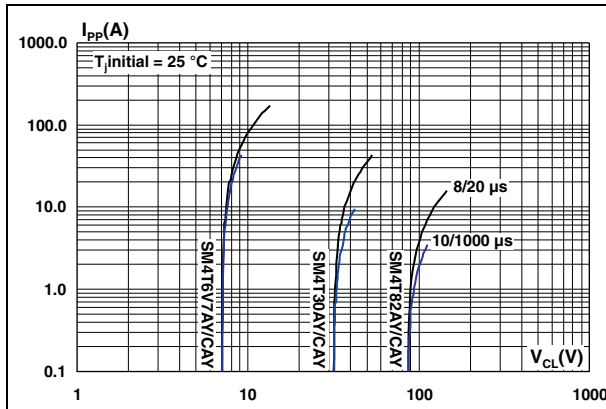

Figure 6. Junction capacitance versus reverse applied voltage for unidirectional types (typical values)

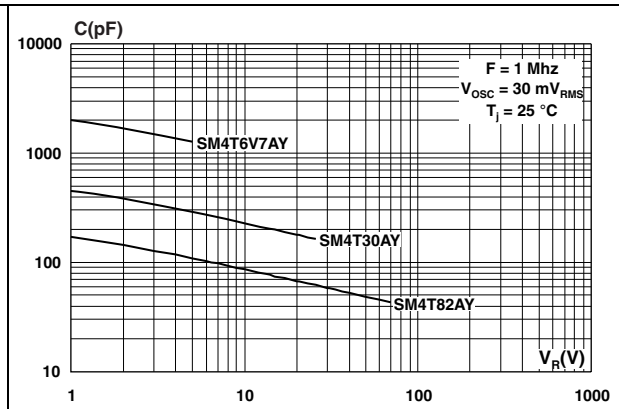

Figure 7. Junction capacitance versus reverse applied voltage for bidirectional types (typical values)

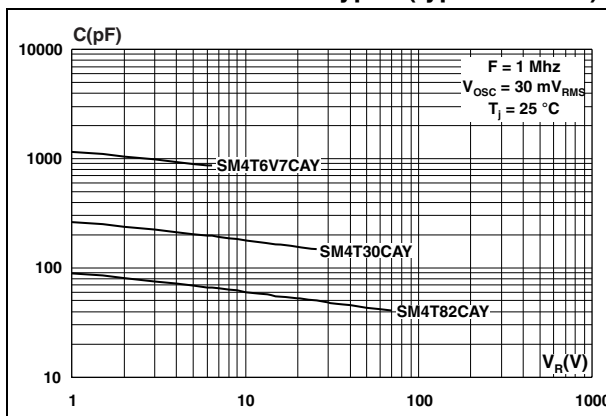
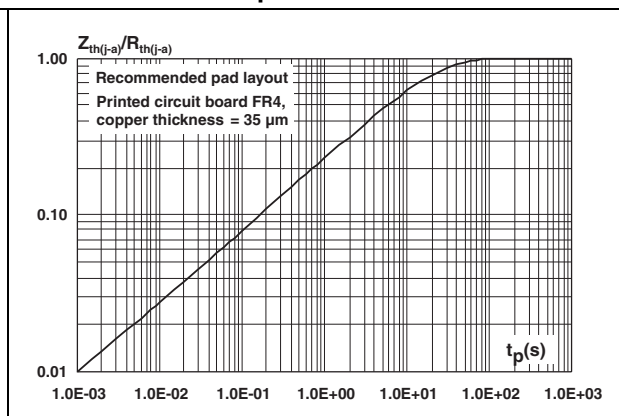
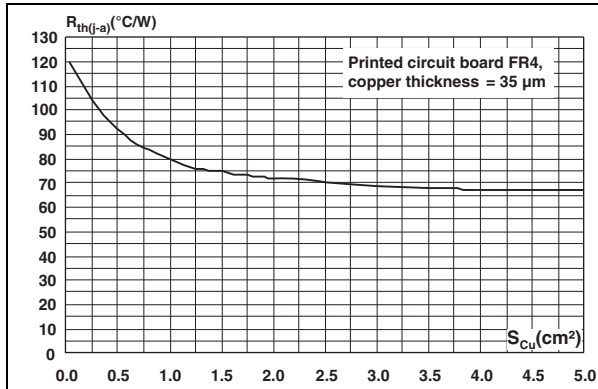

Figure 8. Relative variation of thermal impedance, junction to ambient, versus pulse duration



**Figure 9. Thermal resistance junction to ambient versus copper surface under each lead**



**Figure 10. Leakage current versus junction temperature (typical values)**

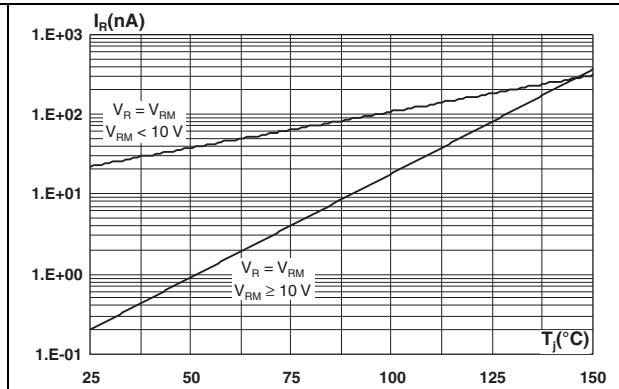

**Figure 11. Peak forward voltage drop versus peak forward current (typical values)**

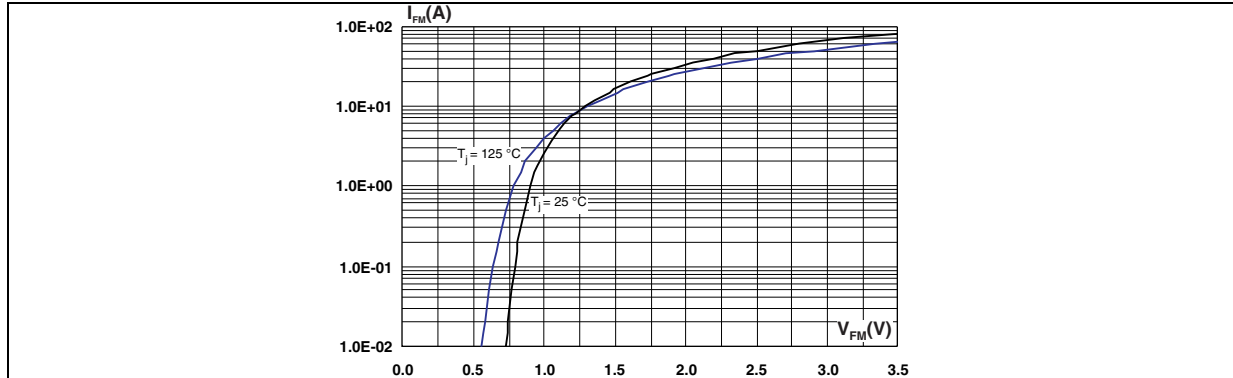

Figure 12. ISO7637-2 pulse 1 response ( $V_S = -100\text{ V}$ )

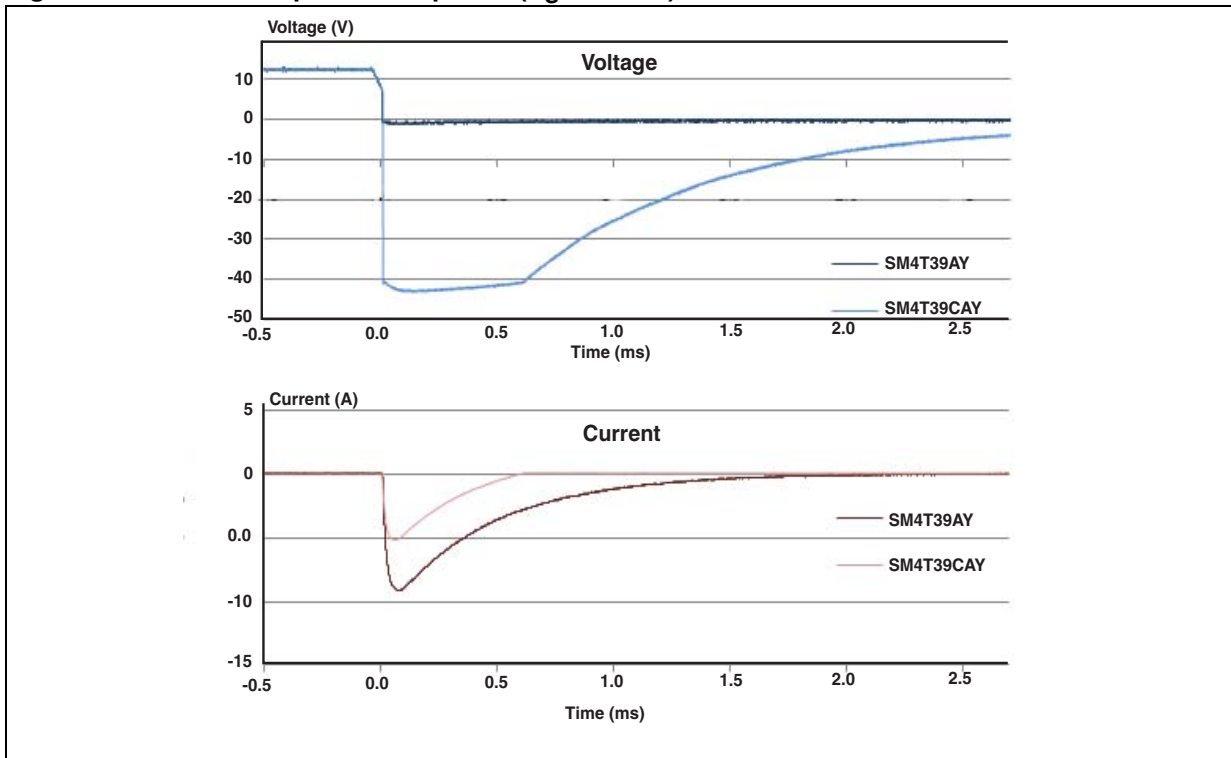

Figure 13. ISO7637-2 pulse 2a response ( $V_S = 50\text{ V}$ )

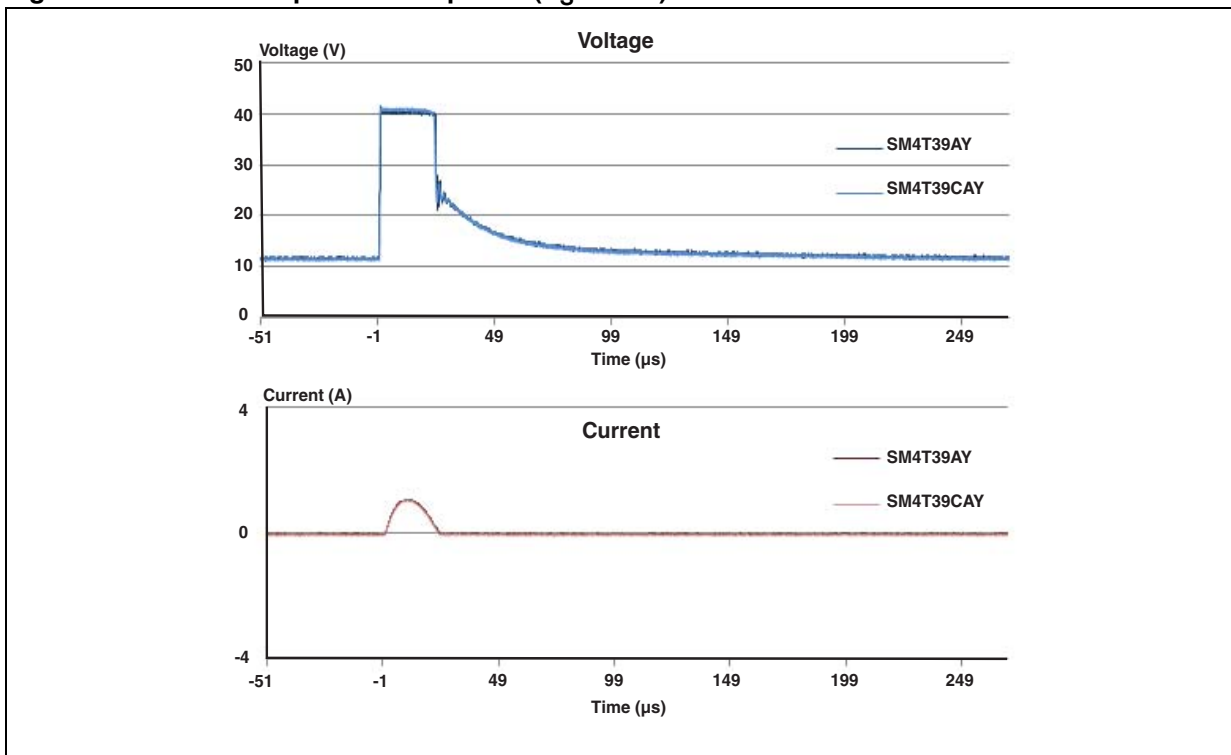

Figure 14. ISO7637-2 pulse 3a response ( $V_S = -150\text{ V}$ )

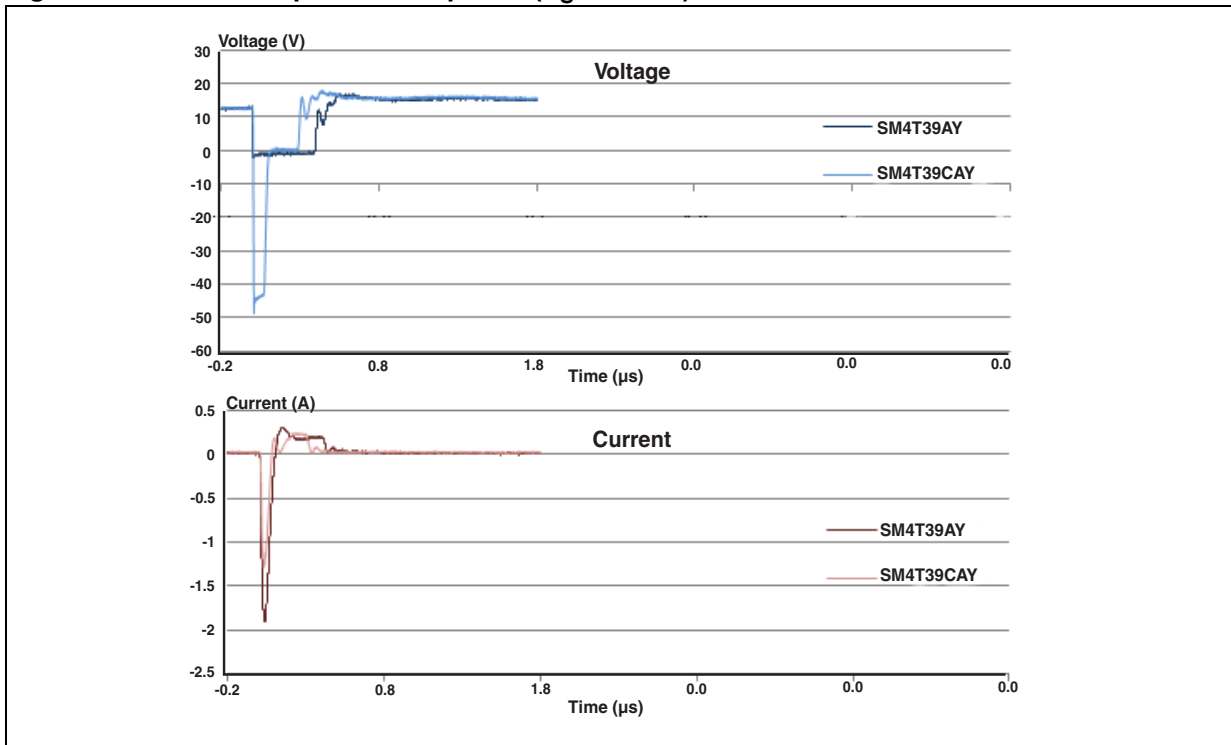
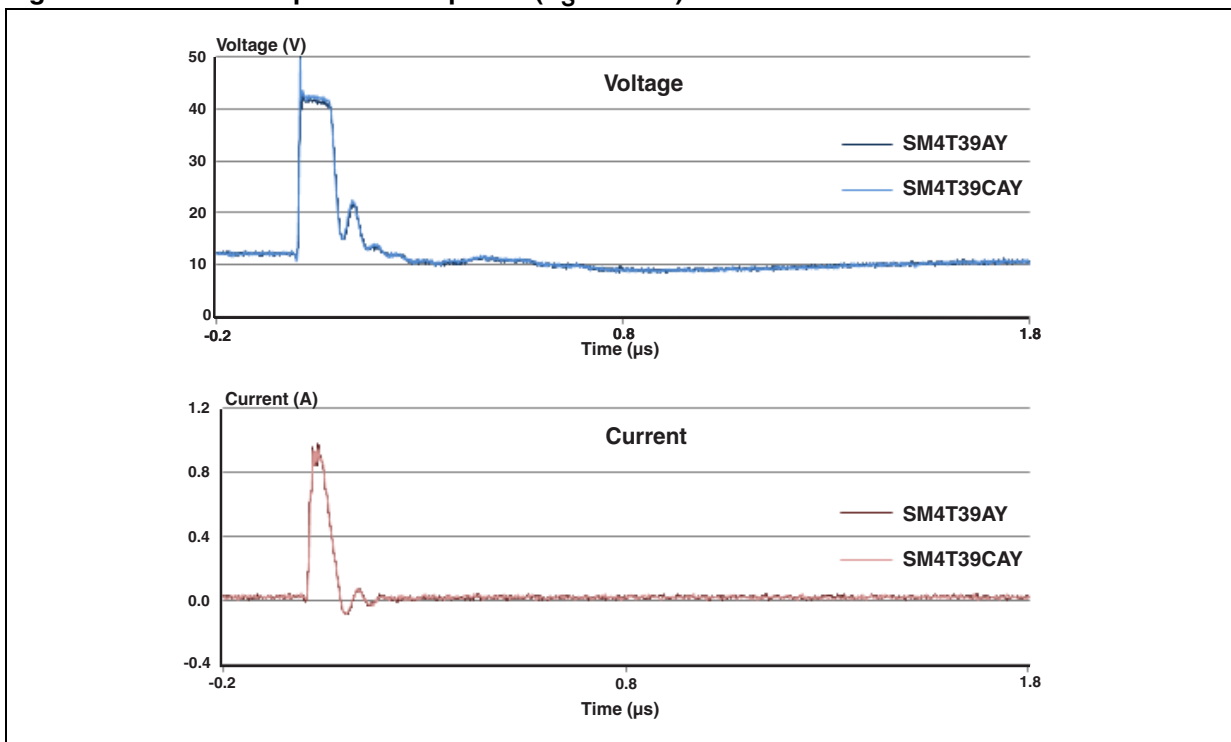

Figure 15. ISO7637-2 pulse 3b response ( $V_S = 100\text{ V}$ )



Note: ISO7637-2 pulses responses are not applicable for product with a stand off voltage lower than the average battery voltage (13.5 V).

## 2 Application and design guidelines

More information is available in the Application note AN2689 “Protection of automotive electronics from electrical hazards, guidelines for design and component selection”.

## 3 Ordering information scheme

Figure 16. Ordering information scheme

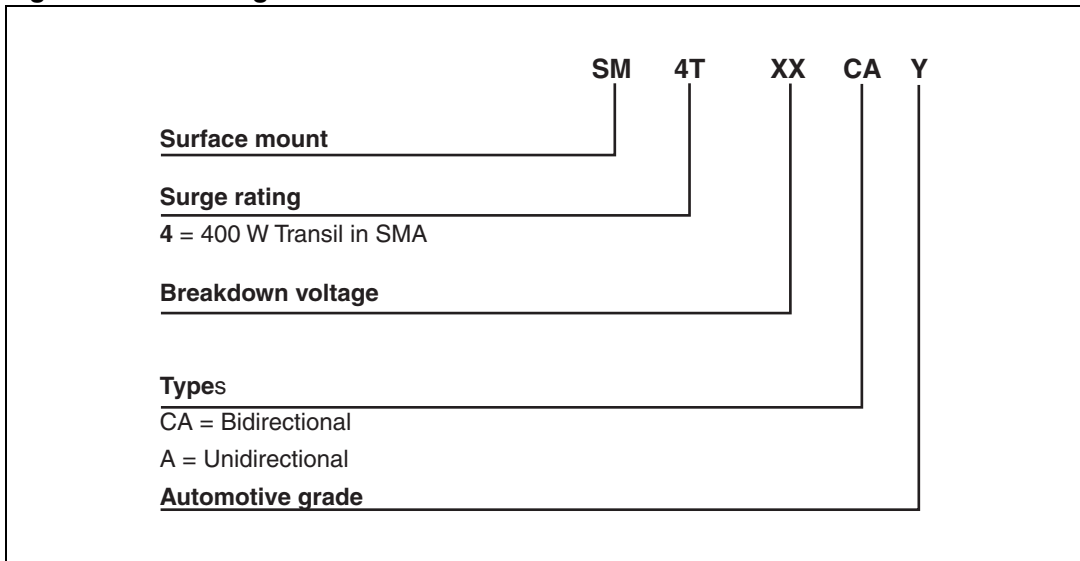



## 4 Package information

- Case: JEDEC DO-214AB molded plastic over planar junction
- Terminals: solder plated, solderable as per MIL-STD-750, Method 2026
- Polarity: for unidirectional types the band indicates cathode
- Flammability: epoxy is rated UL 94, V0
- RoHS package

In order to meet environmental requirements, ST offers these devices in different grades of ECOPACK® packages, depending on their level of environmental compliance. ECOPACK® specifications, grade definitions and product status are available at: [www.st.com](http://www.st.com). ECOPACK® is an ST trademark.

**Table 3. SMA dimensions**

Ref.	Dimensions			
	Millimeters		Inches	
	Min.	Max.	Min.	Max.
A1	1.90	2.45	0.075	0.094
A2	0.05	0.20	0.002	0.008
b	1.25	1.65	0.049	0.065
c	0.15	0.40	0.006	0.016
D	2.25	2.90	0.089	0.114
E	4.80	5.35	0.189	0.211
E1	3.95	4.60	0.156	0.181
L	0.75	1.50	0.030	0.059

**Figure 17. SMA footprint dimensions in mm (inches)**      **Figure 18. Marking layout<sup>(1)</sup>**

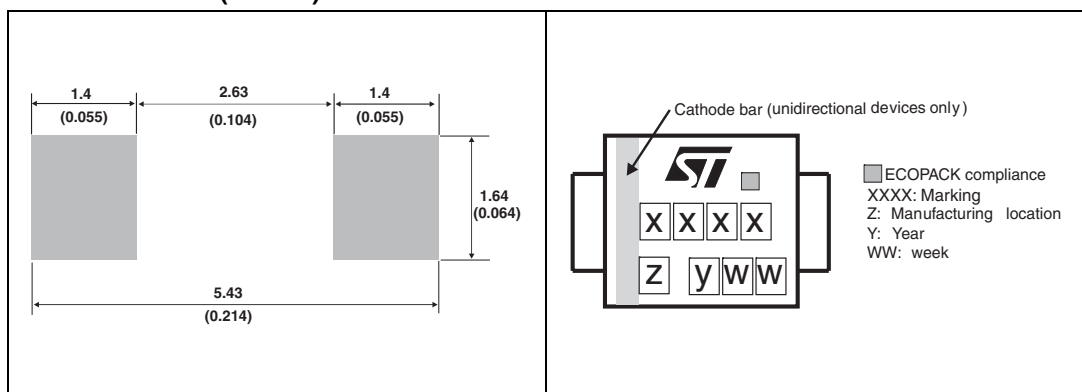

1. Marking layout can vary according to assembly location.

**Table 4. Marking**

Order code	Marking	Order code	Marking
SM4T6V7AY	AEY	SM4T6V7CAY	AAV
SM4T7V6AY	DUCY	SM4T7V5CAY	DBCY
SM4T10AY	DUHY	SM4T10CAY	DBHY
SM4T12AY	AXY	SM4T12CAY	ACY
SM4T14AY	DUKY	SM4T14CAY	DBKY
SM4T15AY	BGY	SM4T15CAY	BHY
SM4T18AY	BMV	SM4T18CAY	AJY
SM4T21AY	DUQY	SM4T21CAY	DBQY
SM4T23AY	DURY	SM4T23CAY	DBRY
SM4T26AY	DUSY	SM4T26CAY	DBSY
SM4T28AY	DUTY	SM4T28CAY	DBTY
SM4T30AY	DUJY	SM4T30CAY	DBUY
SM4T33AY	CGY	SM4T33CAY	CHY
SM4T35AY	CKY	SM4T35CAY	CLY
SM4T39AY	CMY	SM4T39CAY	CNY
SM4T47AY	DUZY	SM4T47CAY	DBZY
SM4T50AY	EUAY	SM4T50CAY	EBAY
SM4T56AY	CXY	SM4T56CAY	CYY
SM4T68AY	EUFY	SM4T68CAY	EBFY
SM4T82AY	EUIY	SM4T82CAY	EBIY

## 5 Ordering information

**Table 5. Ordering information**

Order code	Marking	Package	Weight	Base qty	Delivery mode
SM4TxxxAY/CAY <sup>(1)</sup>	See <a href="#">Table 4 on page 10</a>	SMA	0.072 g	5000	Tape and reel

1. Where xxx is nominal value of  $V_{BR}$  and A or CA indicates unidirectional or bidirectional version. See [Table 2](#) for list of available devices and their order codes

## 6 Revision history

**Table 6. Document revision history**

Date	Revision	Changes
08-Sep-2010	1	Initial release.
09-Nov-2011	2	Added order codes in <a href="#">Table 2</a> and <a href="#">Table 4</a> . Updated <a href="#">Figure 5, 6</a> and <a href="#">7</a> .
27-Mar-2012	3	Added footnote on page 1.

**Please Read Carefully:**

Information in this document is provided solely in connection with ST products. STMicroelectronics NV and its subsidiaries ("ST") reserve the right to make changes, corrections, modifications or improvements, to this document, and the products and services described herein at any time, without notice.

All ST products are sold pursuant to ST's terms and conditions of sale.

Purchasers are solely responsible for the choice, selection and use of the ST products and services described herein, and ST assumes no liability whatsoever relating to the choice, selection or use of the ST products and services described herein.

No license, express or implied, by estoppel or otherwise, to any intellectual property rights is granted under this document. If any part of this document refers to any third party products or services it shall not be deemed a license grant by ST for the use of such third party products or services, or any intellectual property contained therein or considered as a warranty covering the use in any manner whatsoever of such third party products or services or any intellectual property contained therein.

**UNLESS OTHERWISE SET FORTH IN ST'S TERMS AND CONDITIONS OF SALE ST DISCLAIMS ANY EXPRESS OR IMPLIED WARRANTY WITH RESPECT TO THE USE AND/OR SALE OF ST PRODUCTS INCLUDING WITHOUT LIMITATION IMPLIED WARRANTIES OF MERCHANTABILITY, FITNESS FOR A PARTICULAR PURPOSE (AND THEIR EQUIVALENTS UNDER THE LAWS OF ANY JURISDICTION), OR INFRINGEMENT OF ANY PATENT, COPYRIGHT OR OTHER INTELLECTUAL PROPERTY RIGHT.**

**UNLESS EXPRESSLY APPROVED IN WRITING BY TWO AUTHORIZED ST REPRESENTATIVES, ST PRODUCTS ARE NOT RECOMMENDED, AUTHORIZED OR WARRANTED FOR USE IN MILITARY, AIR CRAFT, SPACE, LIFE SAVING, OR LIFE SUSTAINING APPLICATIONS, NOR IN PRODUCTS OR SYSTEMS WHERE FAILURE OR MALFUNCTION MAY RESULT IN PERSONAL INJURY, DEATH, OR SEVERE PROPERTY OR ENVIRONMENTAL DAMAGE. ST PRODUCTS WHICH ARE NOT SPECIFIED AS "AUTOMOTIVE GRADE" MAY ONLY BE USED IN AUTOMOTIVE APPLICATIONS AT USER'S OWN RISK.**

Resale of ST products with provisions different from the statements and/or technical features set forth in this document shall immediately void any warranty granted by ST for the ST product or service described herein and shall not create or extend in any manner whatsoever, any liability of ST.

ST and the ST logo are trademarks or registered trademarks of ST in various countries.

Information in this document supersedes and replaces all information previously supplied.

The ST logo is a registered trademark of STMicroelectronics. All other names are the property of their respective owners.

© 2012 STMicroelectronics - All rights reserved

STMicroelectronics group of companies

Australia - Belgium - Brazil - Canada - China - Czech Republic - Finland - France - Germany - Hong Kong - India - Israel - Italy - Japan - Malaysia - Malta - Morocco - Philippines - Singapore - Spain - Sweden - Switzerland - United Kingdom - United States of America

[www.st.com](http://www.st.com)

# Mouser Electronics

Authorized Distributor

Click to View Pricing, Inventory, Delivery & Lifecycle Information:

## STMicroelectronics:

[SM4T18AY](#) [SM4T18CAY](#) [SM4T21AY](#) [SM4T21CAY](#) [SM4T23AY](#) [SM4T26AY](#) [SM4T26CAY](#) [SM4T28AY](#)  
[SM4T28CAY](#) [SM4T30AY](#) [SM4T33CAY](#) [SM4T35AY](#) [SM4T39AY](#) [SM4T47AY](#) [SM4T47CAY](#) [SM4T56AY](#)  
[SM4T56CAY](#) [SM4T68AY](#) [SM4T68CAY](#) [SM4T6V7CAY](#) [SM4T10AY](#) [SM4T10CAY](#) [SM4T12AY](#) [SM4T12CAY](#)  
[SM4T14CAY](#) [SM4T15AY](#) [SM4T15CAY](#) [SM4T50AY](#) [SM4T50CAY](#) [SM4T6V7AY](#) [SM4T7V6CAY](#) [SM4T82AY](#)  
[SM4T82CAY](#)