

Automotive 600 W Transil™ in SMA package

Datasheet – production data

Features

- Peak pulse power:
 - 600 W (10/1000 μ s)
 - 4 kW (8/20 μ s)
- Stand off voltage range: from 5 V to 70 V
- Unidirectional and bidirectional types
- Low leakage current:
 - 0.2 μ A at 25 °C
 - 1 μ A at 85 °C
- Operating $T_{j\max}$: 150 °C
- JEDEC registered package outline
- Resin meets UL 94, V0
- AEC-Q101 qualified

Complies with the following standards

- ISO 10605, C = 150 pF, R = 330 Ω :
 - 30 kV (air discharge)
 - 30 kV (contact discharge)
- ISO 10605, C = 330 pF, R = 330 Ω :
 - 30 kV (air discharge)
 - 30 kV (contact discharge)
- ISO 7637-2^(a)
 - Pulse 1: $V_S = -100$ V
 - Pulse 2a: $V_S = +50$ V
 - Pulse 3a: $V_S = -150$ V
 - Pulse 3b: $V_S = +100$ V

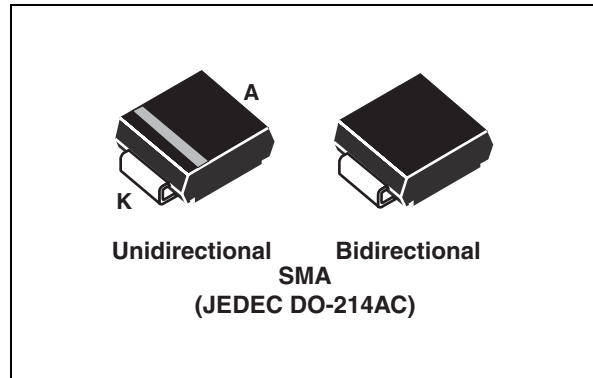

Description

The SMA6TY Transil series has been designed to protect sensitive automotive circuits against surges defined in ISO 7637-2 and against electrostatic discharges according to ISO 10605.

The planar technology makes this device compatible with high-end circuits where low leakage current and high junction temperature are required to provide reliability and stability over time. SMA6TY are packaged in SMA (SMA footprint in accordance with IPC 7531 standard).

a. Not applicable to parts with stand-off voltage lower than the average battery voltage (13.5 V)

TM: Transil is a trademark of STMicroelectronics

1 Characteristics

Table 1. Absolute maximum ratings ($T_{amb} = 25\text{ }^\circ\text{C}$)

Symbol	Parameter		Value	Unit
V_{PP}	Peak pulse voltage	ISO 10605 (C = 330 pF, R = 330 Ω):		
		Contact discharge	30	kV
		Air discharge	30	
		ISO 10605 (C = 150 pF, R = 330 Ω):		
Contact discharge	30			
	Air discharge	30		
P_{PP}	Peak pulse power dissipation ⁽¹⁾	T_j initial = T_{amb}	600	W
T_j	Operating junction temperature range		-40 to 150	$^\circ\text{C}$
T_{stg}	Storage temperature range		-65 to 150	
T_L	Maximum lead temperature for soldering during 10 s.		260	

1. For a surge greater than the maximum values, the diode will fail in short-circuit.

Figure 1. Electrical characteristics - definitions

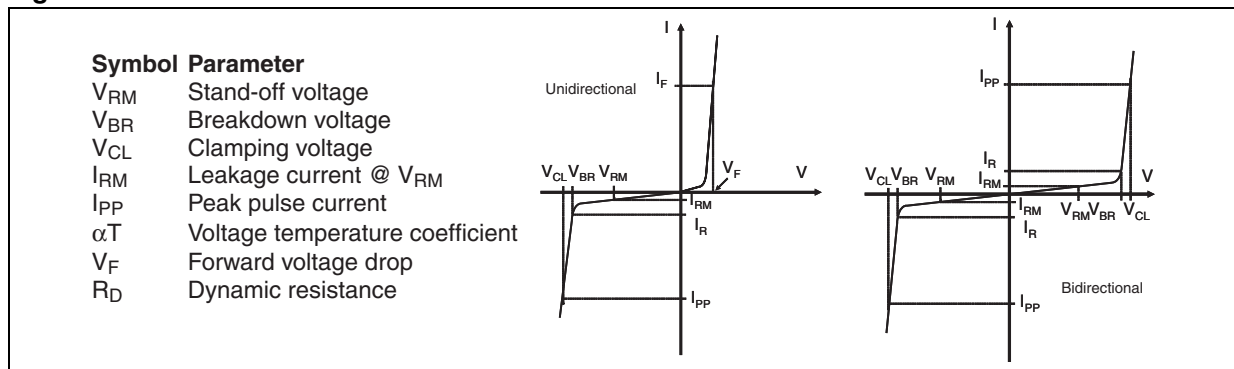

Figure 2. Pulse definition for electrical characteristics

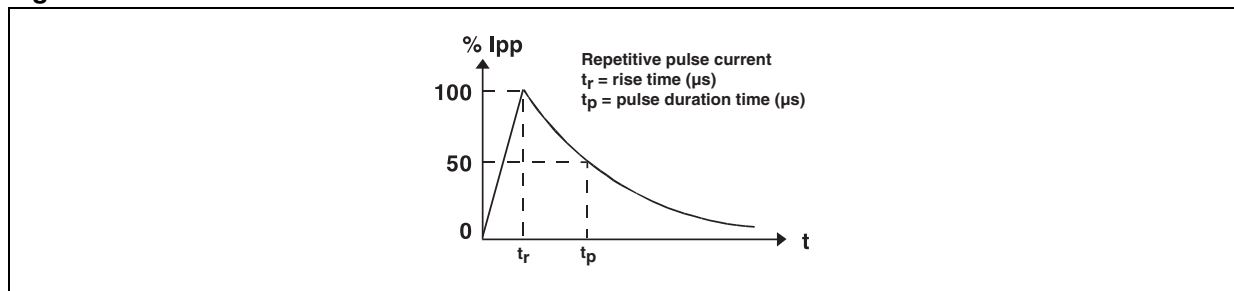

Table 2. Electrical characteristics, parameter values ($T_{amb} = 25\text{ °C}$)

Order code	$I_{RM} \text{ max @ } V_{RM}$		$V_{BR} \text{ @ } I_R^{(1)}$				$V_{CL} \text{ @ } I_{PP}$ 10/1000 μs		$R_D^{(2)}$ 10/1000 μs	$V_{CL} \text{ @ } I_{PP}$ 8/20 μs		$R_D^{(2)}$ 8/20 μs	αT	
	25 °C	85 °C	min.	typ.	max.		max			max			max	
	μA	V	V			mA	V ⁽³⁾	A ⁽⁴⁾	Ω	V ⁽³⁾	A ⁽⁴⁾	Ω	10-4/ °C	
SMA6T6V7AY/CAY	20	50	5.00	6.40	6.70	7.1	10	9.1	68.0	0.029	13.4	298	0.021	5.7
SMA6T7V6AY/CAY	20	50	6.50	7.20	7.60	8.0	10	10.2	56.0	0.04	14.5	276	0.024	6.1
SMA6T10AY/CAY	20	50	8.60	9.50	10.0	10.5	1	14.5	41.0	0.098	18.6	215	0.038	7.3
SMA6T12AY/CAY	0.2	1	10.2	11.4	12.0	12.6	1	16.7	36.0	0.114	21.7	184	0.049	7.8
SMA6T14AY/CAY	0.2	1	12.0	13.3	14.0	14.7	1	18.8	31.0	0.133	23.5	157	0.056	8.3
SMA6T15AY/CAY	0.2	1	12.8	14.3	15.0	15.8	1	21.2	28.0	0.193	27.2	147	0.078	8.4
SMA6T18AY/CAY	0.2	1	15.3	17.1	18.0	18.9	1	25.2	24.0	0.263	32.3	123	0.111	8.8
SMA6T22AY/CAY	0.2	1	18.8	20.9	22.0	23.1	1	30.6	20.0	0.375	39.3	102	0.159	9.2
SMA6T24AY/CAY	0.2	1	20.5	22.8	24.0	25.2	1	33.2	18.0	0.444	42.8	93.0	0.189	9.4
SMA6T28AY/CAY	0.2	1	24.0	26.7	28.1	29.5	1	37.8	16.0	0.516	44.3	80.0	0.184	9.6
SMA6T30AY/CAY	0.2	1	25.6	28.5	30.0	31.5	1	41.5	14.5	0.690	53.5	75.0	0.293	9.7
SMA6T33AY/CAY	0.2	1	28.2	31.4	33.0	34.7	1	45.7	13.1	0.84	59.0	68.0	0.357	9.8
SMA6T39AY/CAY	0.2	1	33.3	37.1	39.0	41.0	1	53.9	11.1	1.16	69.7	57.0	0.504	10
SMA6T47AY/CAY	0.2	1	40.0	44.4	46.7	49.1	1	62.8	9.70	1.42	73.6	48.0	0.511	10.1
SMA6T56AY/CAY	0.2	1	47.6	53.2	56.0	58.8	1	76.6	7.80	2.28	100	40.0	1.030	10.0
SMA6T68AY/CAY	0.2	1	58.1	64.6	68.0	71.4	1	92.0	6.50	3.17	121	33.0	1.50	10.4
SMA6T82AY/CAY	0.2	1	70.0	77.8	81.9	86.0	1	110	5.50	4.38	120	27.0	1.27	10.5

1. Pulse test: $t_p < 50\text{ ms}$

2. To calculate maximum clamping voltage at another surge level, use the following formula:
 $V_{CLmax} = V_{CL} - R_D \times (I_{PP} - I_{PPappli})$ where $I_{PPappli}$ is the surge current in the application.

3. To calculate V_{BR} or V_{CL} versus junction temperature, use the following formulas:
 $V_{BR} @ T_J = V_{BR} @ 25\text{ °C} \times (1 + \alpha T \times (T_J - 25))$
 $V_{CL} @ T_J = V_{CL} @ 25\text{ °C} \times (1 + \alpha T \times (T_J - 25))$

4. Surge capability given for both directions for unidirectional and bidirectional types.

Figure 3. Relative variation of peak power versus initial junction temperature

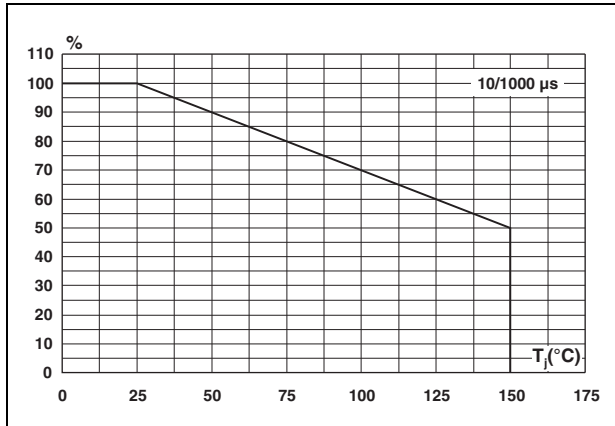

Figure 4. Peak pulse power versus exponential pulse duration

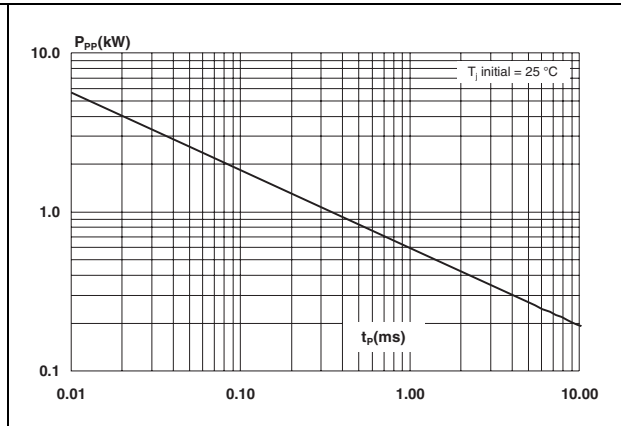

Figure 5. Clamping voltage versus peak pulse current exponential waveform (maximum values)

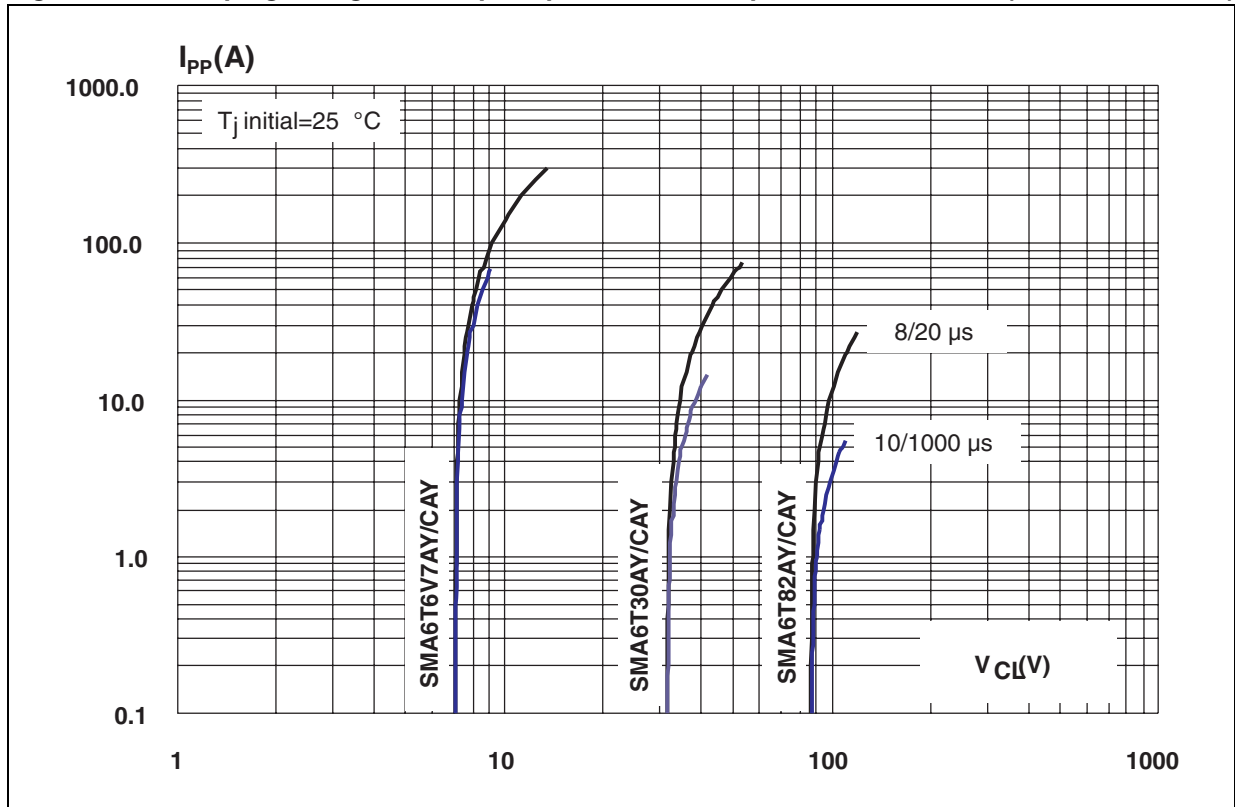

Figure 6. ISO 7637-2 pulse 1 response ($V_S = -100\text{ V}$)

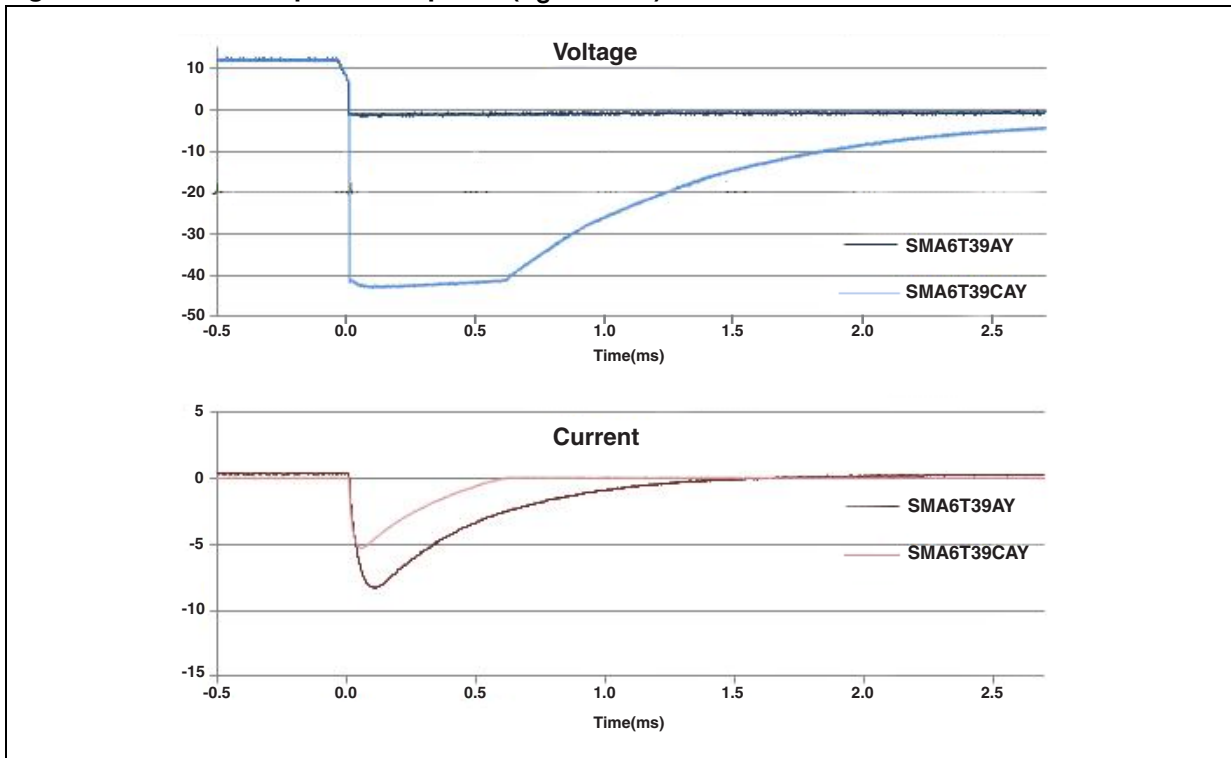

Figure 7. ISO 7637-2 pulse 2a response ($V_S = 50\text{ V}$)

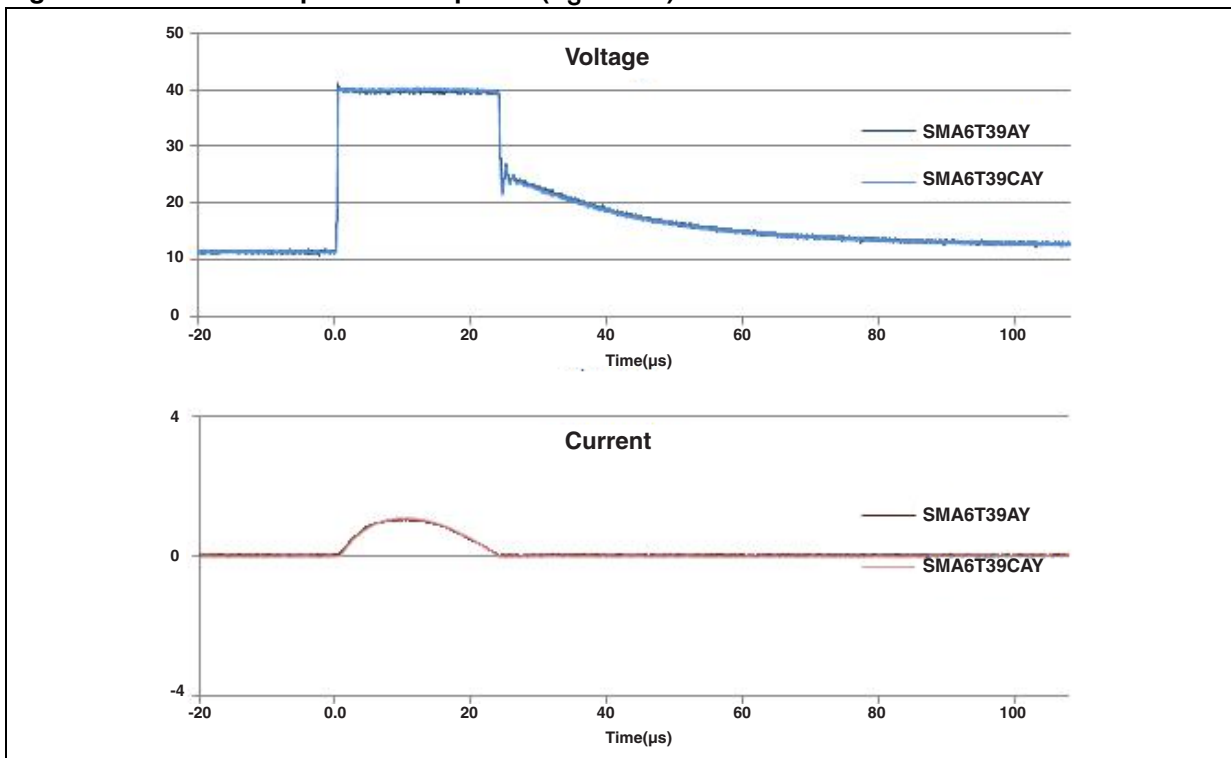

Figure 8. ISO 7637-2 pulse 3a response ($V_S = -150\text{ V}$)

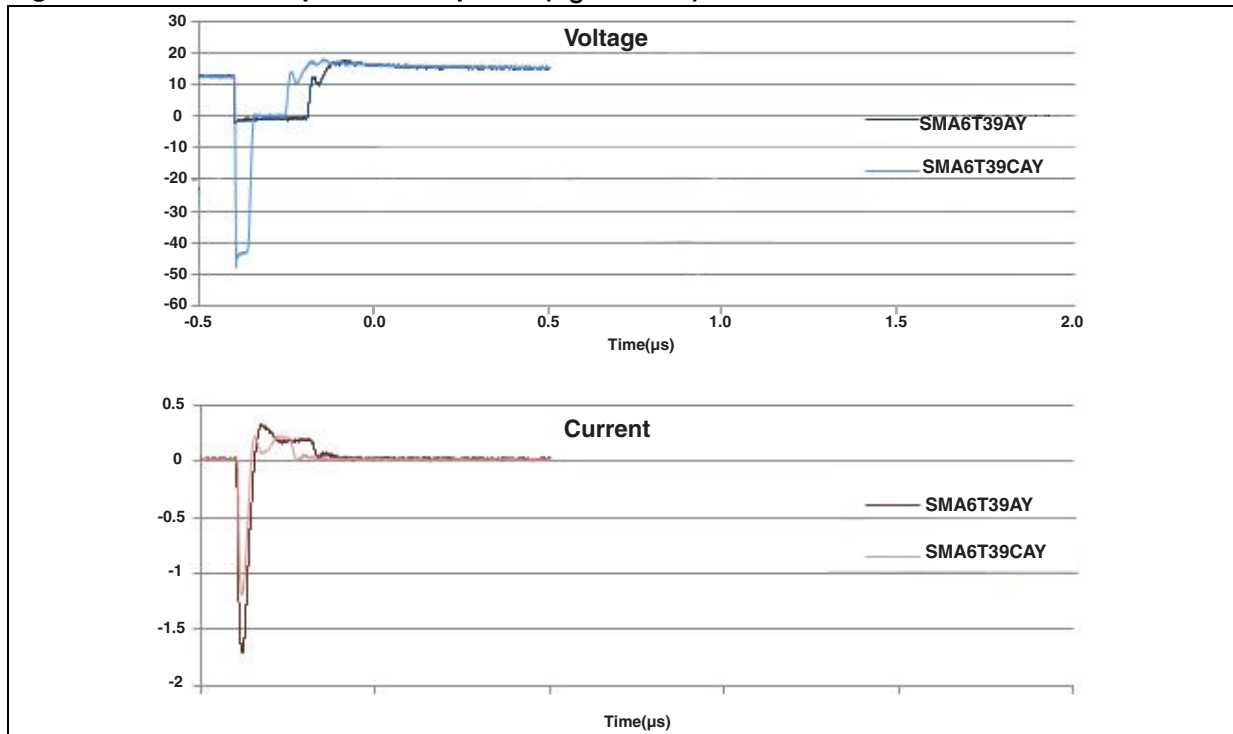
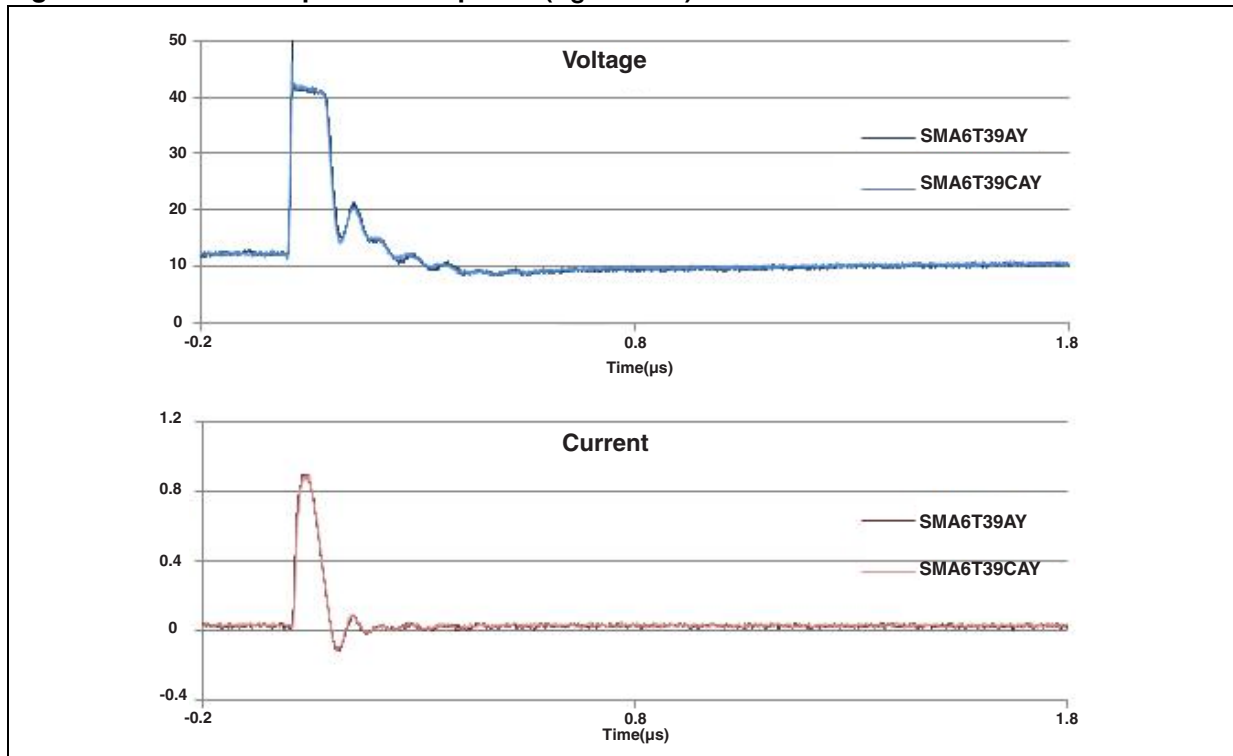

Figure 9. ISO 7637-2 pulse 3b response ($V_S = 100\text{ V}$)



Note: ISO7637-2 pulses responses are not applicable for products with a stand off voltage lower than the average battery voltage (13.5 V).

Figure 10. Junction capacitance versus reverse applied voltage for unidirectional types (typical values)

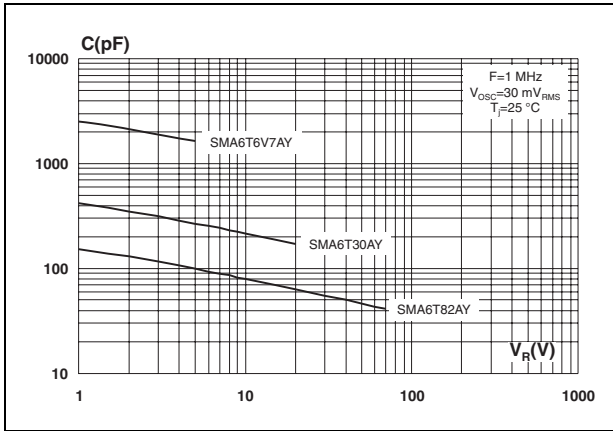

Figure 11. Junction capacitance versus reverse applied voltage for bidirectional types (typical values)

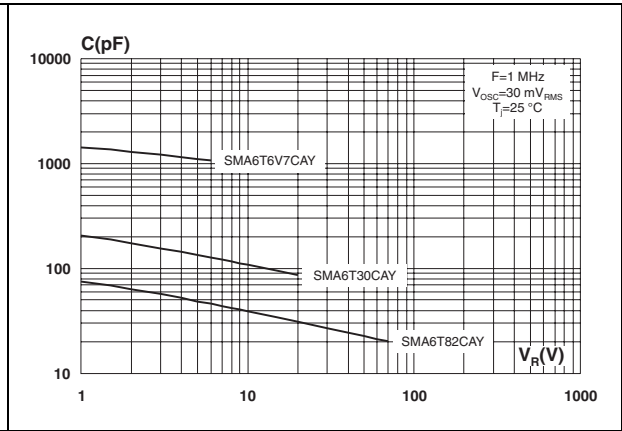

Figure 12. Relative variation of thermal impedance, junction to ambient, versus pulse duration

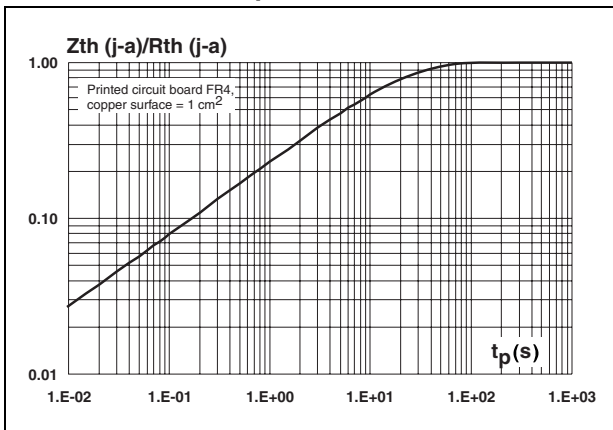

Figure 13. Thermal resistance junction to ambient versus copper surface under each lead

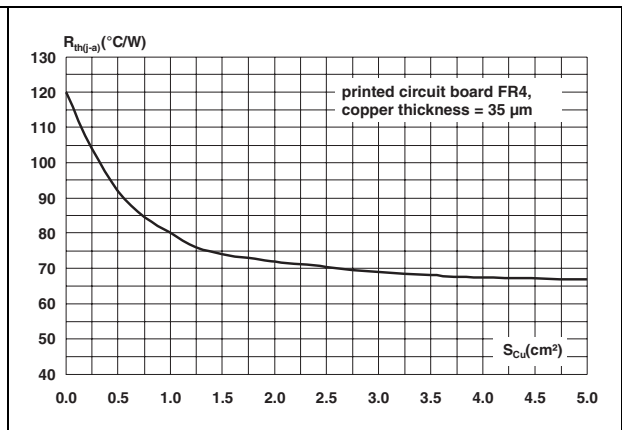

Figure 14. Leakage current versus junction temperature (typical values)

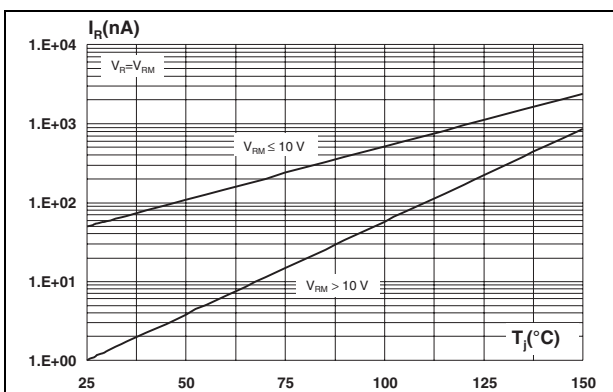
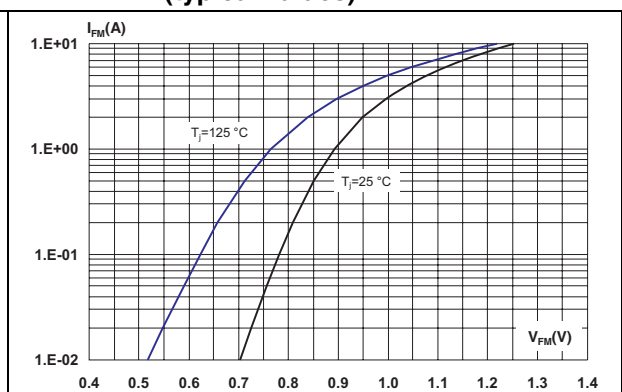

Figure 15. Peak forward voltage drop versus peak forward current (typical values)



2 Application and design guidelines

More information is available in the ST Application note AN2689 “Protection of automotive electronics from electrical hazards, guidelines for design and component selection”.

3 Ordering information scheme

Figure 16. Ordering information scheme

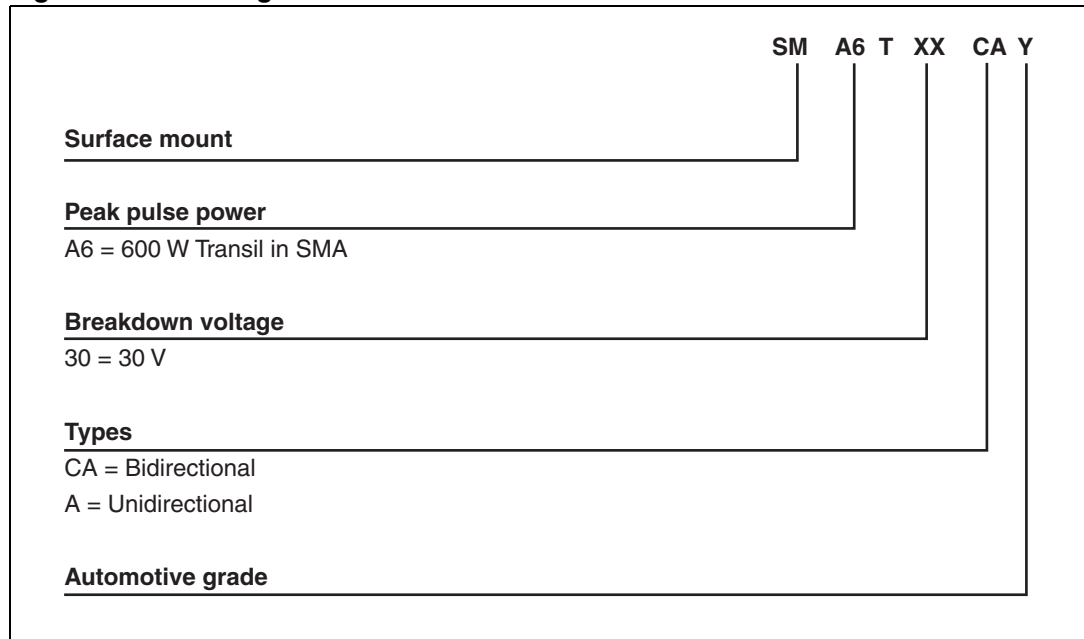

4 Packaging information

- Case: JEDEC DO-214AA molded plastic over planar junction
- Terminals: solder plated, solderable as per MIL-STD-750, Method 2026
- Polarity: for unidirectional types the band indicates cathode
- Flammability: epoxy meets UL 94, V0
- RoHS package

In order to meet environmental requirements, ST offers these devices in different grades of ECOPACK® packages, depending on their level of environmental compliance. ECOPACK® specifications, grade definitions and product status are available at: www.st.com. ECOPACK® is an ST trademark.

Table 3. SMA dimensions

Ref.	Dimensions			
	Millimeters		Inches	
	Min.	Max.	Min.	Max.
A1	1.90	2.45	0.075	0.094
A2	0.05	0.20	0.002	0.008
b	1.25	1.65	0.049	0.065
c	0.15	0.40	0.006	0.016
D	2.25	2.90	0.089	0.114
E	4.80	5.35	0.189	0.211
E1	3.95	4.60	0.156	0.181
L	0.75	1.50	0.030	0.059

Figure 17. SMA footprint dimensions in mm (inches)

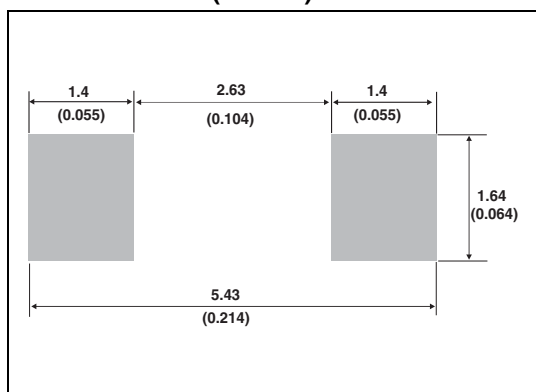
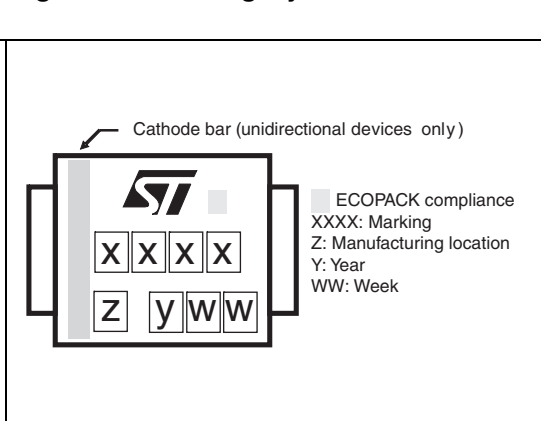

Figure 18. Marking layout⁽¹⁾



1. Marking layout can vary according to assembly location.

Table 4. Marking

Order code	Marking	Order code	Marking
SMA6T6V7AY	6UAY	SMA6T6V7CAY	6BAY
SMA6T7V6AY	6UCY	SMA6T7V6CAY	6BCY
SMA6T10AY	6UDY	SMA6T10CAY	6BDY
SMA6T12AY	6UEY	SMA6T12CAY	6BEY
SMA6T14AY	6UFY	SMA6T14CAY	6BFY
SMA6T15AY	6UGY	SMA6T15CAY	6BGY
SMA6T18AY	6UHY	SMA6T18CAY	6BHY
SMA6T22AY	6UJY	SMA6T22CAY	6BJY
SMA6T24AY	6UKY	SMA6T24CAY	6BKY
SMA6T28AY	6UMY	SMA6T28CAY	6BMY
SMA6T30AY	6UNY	SMA6T30CAY	6BNY
SMA6T33AY	6UOY	SMA6T33CAY	6BOY
SMA6T39AY	6UQY	SMA6T39CAY	6BQY
SMA6T47AY	6URY	SMA6T47CAY	6BRY
SMA6T56AY	6USY	SMA6T56CAY	6BSY
SMA6T68AY	6UTY	SMA6T68CAY	6BTY
SMA6T82AY	6UUY	SMA6T82CAY	6BUY

5 Ordering information

Table 5. Ordering information

Order code	Marking	Package	Weight	Base qty	Delivery mode
SMA6TxxxAY/CAY ⁽¹⁾	See Table 4	SMA	0.072 g	5000	Tape and reel

1. Where xxx is nominal value of V_{BR} and A or CA indicates unidirectional or bidirectional version. See [Table 2](#) for list of available devices and their order codes

6 Revision history

Table 6. Document revision history

Date	Revision	Changes
30-Aug-2010	1	Initial release.
17-Oct-2011	2	Deleted old Table 2. Thermal parameter. Updated Table 2 and order codes in Table 2 and Table 4 . Updated Figure 5 , 10 and 11 .
27-Mar-2012	3	Added footnote on page 1.

Please Read Carefully:

Information in this document is provided solely in connection with ST products. STMicroelectronics NV and its subsidiaries ("ST") reserve the right to make changes, corrections, modifications or improvements, to this document, and the products and services described herein at any time, without notice.

All ST products are sold pursuant to ST's terms and conditions of sale.

Purchasers are solely responsible for the choice, selection and use of the ST products and services described herein, and ST assumes no liability whatsoever relating to the choice, selection or use of the ST products and services described herein.

No license, express or implied, by estoppel or otherwise, to any intellectual property rights is granted under this document. If any part of this document refers to any third party products or services it shall not be deemed a license grant by ST for the use of such third party products or services, or any intellectual property contained therein or considered as a warranty covering the use in any manner whatsoever of such third party products or services or any intellectual property contained therein.

UNLESS OTHERWISE SET FORTH IN ST'S TERMS AND CONDITIONS OF SALE ST DISCLAIMS ANY EXPRESS OR IMPLIED WARRANTY WITH RESPECT TO THE USE AND/OR SALE OF ST PRODUCTS INCLUDING WITHOUT LIMITATION IMPLIED WARRANTIES OF MERCHANTABILITY, FITNESS FOR A PARTICULAR PURPOSE (AND THEIR EQUIVALENTS UNDER THE LAWS OF ANY JURISDICTION), OR INFRINGEMENT OF ANY PATENT, COPYRIGHT OR OTHER INTELLECTUAL PROPERTY RIGHT.

UNLESS EXPRESSLY APPROVED IN WRITING BY TWO AUTHORIZED ST REPRESENTATIVES, ST PRODUCTS ARE NOT RECOMMENDED, AUTHORIZED OR WARRANTED FOR USE IN MILITARY, AIR CRAFT, SPACE, LIFE SAVING, OR LIFE SUSTAINING APPLICATIONS, NOR IN PRODUCTS OR SYSTEMS WHERE FAILURE OR MALFUNCTION MAY RESULT IN PERSONAL INJURY, DEATH, OR SEVERE PROPERTY OR ENVIRONMENTAL DAMAGE. ST PRODUCTS WHICH ARE NOT SPECIFIED AS "AUTOMOTIVE GRADE" MAY ONLY BE USED IN AUTOMOTIVE APPLICATIONS AT USER'S OWN RISK.

Resale of ST products with provisions different from the statements and/or technical features set forth in this document shall immediately void any warranty granted by ST for the ST product or service described herein and shall not create or extend in any manner whatsoever, any liability of ST.

ST and the ST logo are trademarks or registered trademarks of ST in various countries.

Information in this document supersedes and replaces all information previously supplied.

The ST logo is a registered trademark of STMicroelectronics. All other names are the property of their respective owners.

© 2012 STMicroelectronics - All rights reserved

STMicroelectronics group of companies

Australia - Belgium - Brazil - Canada - China - Czech Republic - Finland - France - Germany - Hong Kong - India - Israel - Italy - Japan - Malaysia - Malta - Morocco - Philippines - Singapore - Spain - Sweden - Switzerland - United Kingdom - United States of America

www.st.com

Mouser Electronics

Authorized Distributor

Click to View Pricing, Inventory, Delivery & Lifecycle Information:

STMicroelectronics:

[SMA6T24CAY](#) [SMA6T30AY](#) [SMA6T33AY](#) [SMA6T39CAY](#) [SMA6T12AY](#) [SMA6T12CAY](#) [SMA6T15AY](#) [SMA6T18AY](#)
[SMA6T18CAY](#) [SMA6T6V7AY](#) [SMA6T6V7CAY](#) [SMA6T7V6AY](#)