

Infrared Emitting Diode, 950 nm, GaAs

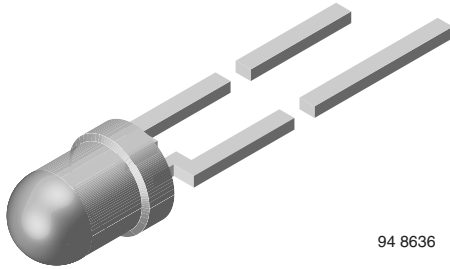

94 8636

DESCRIPTION

TSUS4400 is an infrared, 950 nm emitting diode in GaAs technology molded in a blue tinted plastic package.

FEATURES

- Package type: leaded
- Package form: T-1
- Dimensions (in mm): \varnothing 3
- Peak wavelength: $\lambda_p = 950$ nm
- High reliability
- Angle of half intensity: $\varphi = \pm 18^\circ$
- Low forward voltage
- Suitable for high pulse current operation
- Good spectral matching with Si photodetectors
- Material categorization: for definitions of compliance please see www.vishay.com/doc?99912



APPLICATIONS

- Infrared remote control and free air transmission systems with low forward voltage and small package requirements
- Emitter in transmissive sensors
- Emitter in reflective sensors

PRODUCT SUMMARY

COMPONENT	I_e (mW/sr)	φ (deg)	λ_p (nm)	t_r (ns)
TSUS4400	15	± 18	950	800

Note

- Test conditions see table "Basic Characteristics"

ORDERING INFORMATION

ORDERING CODE	PACKAGING	REMARKS	PACKAGE FORM
TSUS4400	Bulk	MOQ: 5000 pcs, 5000 pcs/bulk	T-1

Note

- MOQ: minimum order quantity

ABSOLUTE MAXIMUM RATINGS ($T_{amb} = 25^\circ\text{C}$, unless otherwise specified)

PARAMETER	TEST CONDITION	SYMBOL	VALUE	UNIT
Reverse voltage		V_R	5	V
Forward current		I_F	100	mA
Peak forward current	$t_p/T = 0.5$, $t_p = 100 \mu\text{s}$	I_{FM}	200	mA
Surge forward current	$t_p = 100 \mu\text{s}$	I_{FSM}	2	A
Power dissipation		P_V	170	mW
Junction temperature		T_j	100	$^\circ\text{C}$
Operating temperature range		T_{amb}	-40 to + 85	$^\circ\text{C}$
Storage temperature range		T_{stg}	-40 to +100	$^\circ\text{C}$
Soldering temperature	$t \leq 5$ s, 2 mm from case	T_{sd}	260	$^\circ\text{C}$
Thermal resistance junction/ambient	J-STD-051, leads 7 mm, soldered on PCB	R_{thJA}	300	K/W

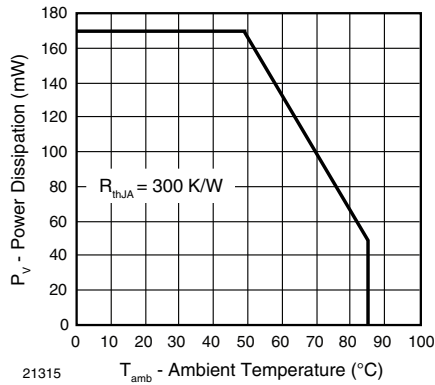

Fig. 1 - Power Dissipation Limit vs. Ambient Temperature

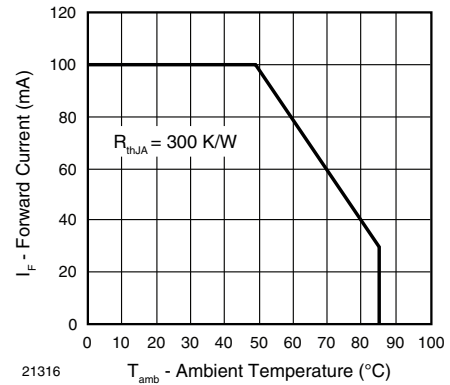

Fig. 2 - Forward Current Limit vs. Ambient Temperature

BASIC CHARACTERISTICS ($T_{amb} = 25\text{ }^{\circ}\text{C}$, unless otherwise specified)						
PARAMETER	TEST CONDITION	SYMBOL	MIN.	TYP.	MAX.	UNIT
Forward voltage	$I_F = 100\text{ mA}$, $t_p = 20\text{ ms}$	V_F		1.3	1.7	V
	$I_F = 1.5\text{ A}$, $t_p = 100\text{ }\mu\text{s}$	V_F		2.2		V
Temperature coefficient of V_F	$I_F = 100\text{ mA}$	TK_{V_F}		-1.3		mV/K
Reverse current	$V_R = 5\text{ V}$	I_R			100	μA
Breakdown voltage	$I_R = 100\text{ }\mu\text{A}$	$V_{(BR)}$	5	40		μA
Junction capacitance	$V_R = 0\text{ V}$, $f = 1\text{ MHz}$, $E = 0$	C_j		30		pF
Radiant intensity	$I_F = 100\text{ mA}$, $t_p = 20\text{ ms}$	I_e	7	15	35	mW/sr
	$I_F = 1.5\text{ A}$, $t_p = 100\text{ }\mu\text{s}$	I_e		140		mW/sr
Radiant power	$I_F = 100\text{ mA}$, $t_p = 20\text{ ms}$	ϕ_e		20		mW
Temperature coefficient of ϕ_e	$I_F = 20\text{ mA}$	TK_{ϕ_e}		-0.8		%/K
Angle of half intensity		φ		± 18		deg
Peak wavelength	$I_F = 100\text{ mA}$	λ_p		950		nm
Spectral bandwidth	$I_F = 100\text{ mA}$	$\Delta\lambda$		50		nm
Temperature coefficient of λ_p	$I_F = 100\text{ mA}$	TK_{λ_p}		0.2		nm/K
Rise time	$I_F = 100\text{ mA}$	t_r		800		ns
	$I_F = 1.5\text{ A}$	t_r		400		ns
Fall time	$I_F = 100\text{ mA}$	t_f		800		ns
	$I_F = 1.5\text{ A}$	t_f		400		ns
Virtual source diameter		d		2.1		mm

BASIC CHARACTERISTICS ($T_{amb} = 25\text{ }^{\circ}\text{C}$, unless otherwise specified)

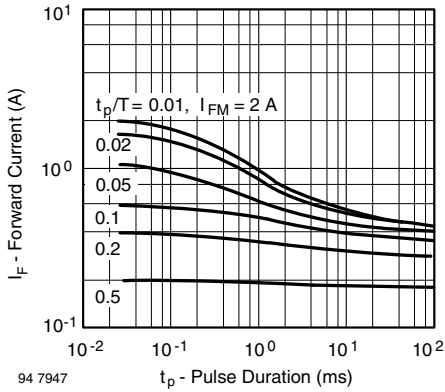

Fig. 3 - Pulse Forward Current vs. Pulse Duration

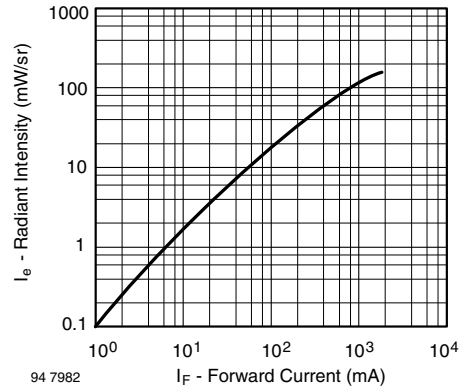

Fig. 6 - Radiant Intensity vs. Forward Current

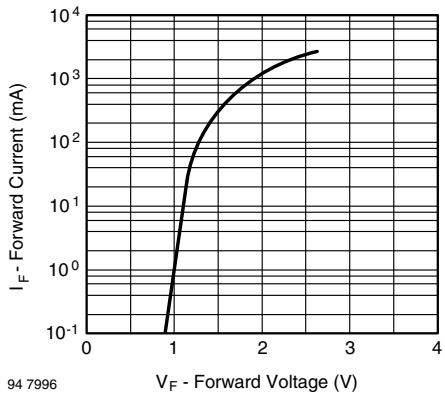

Fig. 4 - Forward Current vs. Forward Voltage

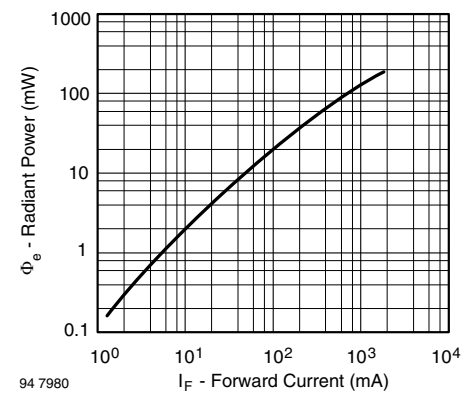

Fig. 7 - Radiant Power vs. Forward Current

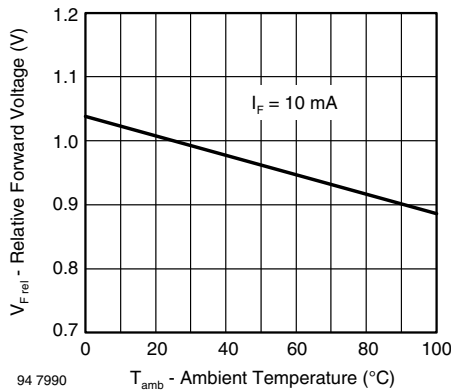

Fig. 5 - Relative Forward Voltage vs. Ambient Temperature

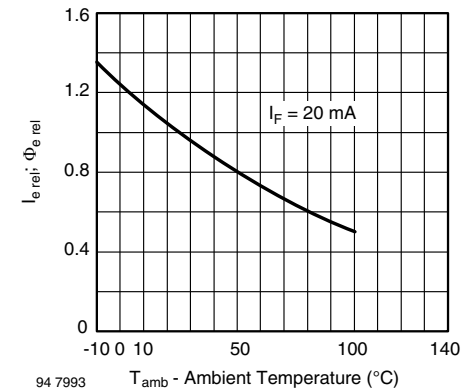

Fig. 8 - Relative Radiant Intensity/Power vs. Ambient Temperature

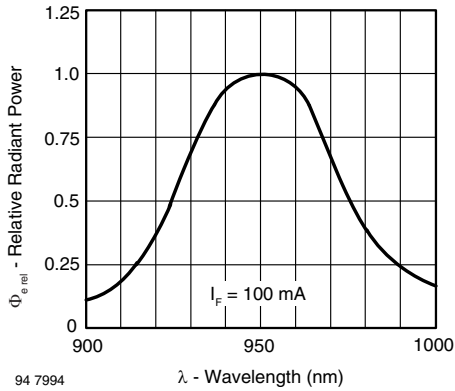

Fig. 9 - Relative Radiant Power vs. Wavelength

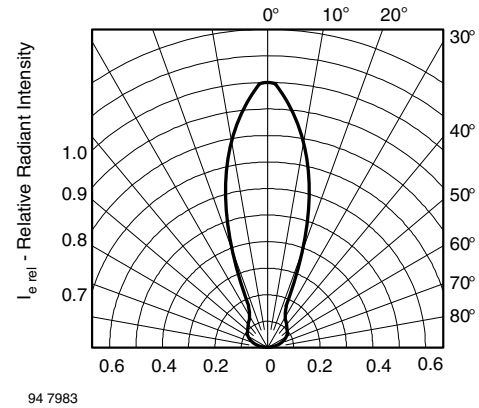
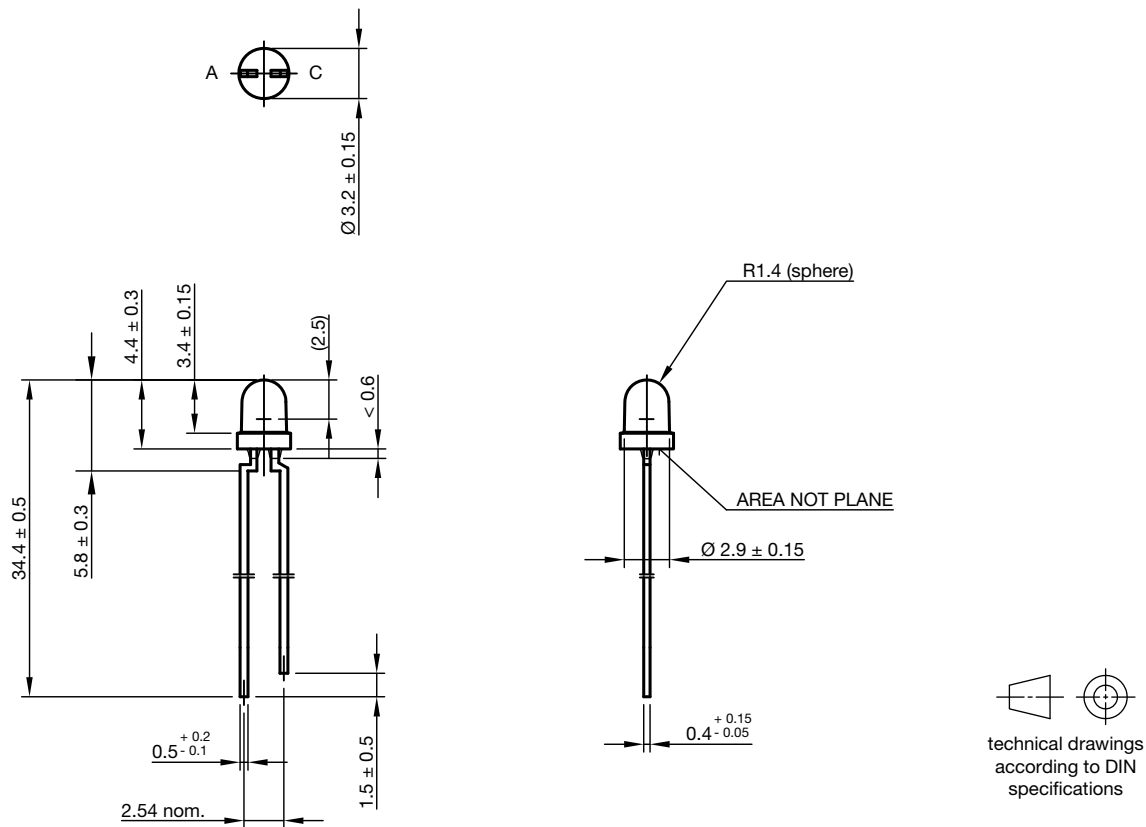

Fig. 10 - Relative Radiant Intensity vs. Angular Displacement

PACKAGE DIMENSIONS in millimeters



Drawing-No.: 6.544-5255.01-4
Issue: 9; 28.07.14



Disclaimer

ALL PRODUCT, PRODUCT SPECIFICATIONS AND DATA ARE SUBJECT TO CHANGE WITHOUT NOTICE TO IMPROVE RELIABILITY, FUNCTION OR DESIGN OR OTHERWISE.

Vishay Intertechnology, Inc., its affiliates, agents, and employees, and all persons acting on its or their behalf (collectively, "Vishay"), disclaim any and all liability for any errors, inaccuracies or incompleteness contained in any datasheet or in any other disclosure relating to any product.

Vishay makes no warranty, representation or guarantee regarding the suitability of the products for any particular purpose or the continuing production of any product. To the maximum extent permitted by applicable law, Vishay disclaims (i) any and all liability arising out of the application or use of any product, (ii) any and all liability, including without limitation special, consequential or incidental damages, and (iii) any and all implied warranties, including warranties of fitness for particular purpose, non-infringement and merchantability.

Statements regarding the suitability of products for certain types of applications are based on Vishay's knowledge of typical requirements that are often placed on Vishay products in generic applications. Such statements are not binding statements about the suitability of products for a particular application. It is the customer's responsibility to validate that a particular product with the properties described in the product specification is suitable for use in a particular application. Parameters provided in datasheets and/or specifications may vary in different applications and performance may vary over time. All operating parameters, including typical parameters, must be validated for each customer application by the customer's technical experts. Product specifications do not expand or otherwise modify Vishay's terms and conditions of purchase, including but not limited to the warranty expressed therein.

Except as expressly indicated in writing, Vishay products are not designed for use in medical, life-saving, or life-sustaining applications or for any other application in which the failure of the Vishay product could result in personal injury or death. Customers using or selling Vishay products not expressly indicated for use in such applications do so at their own risk. Please contact authorized Vishay personnel to obtain written terms and conditions regarding products designed for such applications.

No license, express or implied, by estoppel or otherwise, to any intellectual property rights is granted by this document or by any conduct of Vishay. Product names and markings noted herein may be trademarks of their respective owners.

Material Category Policy

Vishay Intertechnology, Inc. hereby certifies that all its products that are identified as RoHS-Compliant fulfill the definitions and restrictions defined under Directive 2011/65/EU of The European Parliament and of the Council of June 8, 2011 on the restriction of the use of certain hazardous substances in electrical and electronic equipment (EEE) - recast, unless otherwise specified as non-compliant.

Please note that some Vishay documentation may still make reference to RoHS Directive 2002/95/EC. We confirm that all the products identified as being compliant to Directive 2002/95/EC conform to Directive 2011/65/EU.

Vishay Intertechnology, Inc. hereby certifies that all its products that are identified as Halogen-Free follow Halogen-Free requirements as per JEDEC JS709A standards. Please note that some Vishay documentation may still make reference to the IEC 61249-2-21 definition. We confirm that all the products identified as being compliant to IEC 61249-2-21 conform to JEDEC JS709A standards.