

DS3695/DS3695T/DS3696/DS3697 Multipoint RS485/RS422 Transceivers/Repeaters

General Description

The DS3695, DS3696, and DS3697 are high speed differential TRI-STATE® bus/line transceivers/repeaters designed to meet the requirements of EIA standard RS485 with extended common mode range (+12V to -7V), for multipoint data transmission.

The driver and receiver outputs feature TRI-STATE capability. The driver outputs remain in TRI-STATE over the entire common mode range of +12V to -7V. Bus faults that cause excessive power dissipation within the device trigger a thermal shutdown circuit, which forces the driver outputs into the high impedance state. The DS3696 provides an output pin TS (thermal shutdown) which reports the occurrence of the thermal shutdown of the device. This is an "open collector" pin with an internal 10 kΩ pull-up resistor. This allows the line fault outputs of several devices to be wire OR-ed.

Both AC and DC specifications are guaranteed over the 0°C to 70°C temperature and 4.75V to 5.25V supply voltage range.

Features

- Meets EIA standard RS485 for multipoint bus transmission and is compatible with RS-422
- 15 ns driver propagation delays with 2 ns skew (typical)
- Single +5V supply
- -7V to +12V bus common mode range permits ±7V ground difference between devices on the bus
- Thermal shutdown protection
- High impedance to bus with driver in TRI-STATE or with power off, over the entire common mode range allows the unused devices on the bus to be powered down
- Combined impedance of a driver output and receiver input is less than one RS485 unit load, allowing up to 32 transceivers on the bus
- 70 mV typical receiver hysteresis

Connection and Logic Diagrams

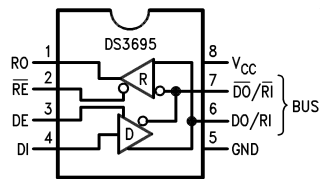

DS010408-1

Top View

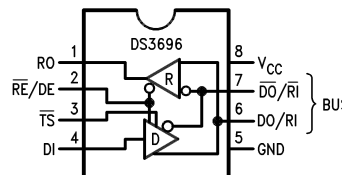

DS010408-12

Top View

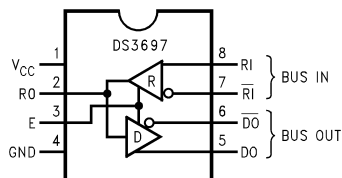

DS010408-13

Top View

Order Number DS3695N, DS3695TN,
DS3696N, or DS3697N
See NS Package Number N08E

Note 1: \overline{TS} pin was \overline{LF} (Line Fault) in previous datasheets and reports the occurrence of a thermal shutdown of the device.

Absolute Maximum Ratings (Note 2)

If Military/Aerospace specified devices are required, please contact the National Semiconductor Sales Office/Distributors for availability and specifications.

Supply Voltage, V_{CC}	7V
Control Input Voltages	7V
Driver Input Voltage	7V
Driver Output Voltages	+15V/-10V
Receiver Input Voltages (DS3695, DS3696)	+15V/-10V
Receiver Common Mode Voltage (DS3697)	±25V
Receiver Output Voltage	5.5V
Continuous Power Dissipation @ 25°C N Package	1.07W (Note 4)

Storage Temperature Range	-65°C to +150°C
Lead Temperature (Soldering, 4 sec.)	260°C

Recommended Operating Conditions

	Min	Max	Units
Supply Voltage, V_{CC}	4.75	5.25	V
Bus Voltage	-7	+12	V
Operating Free Air Temp. (T_A)			
Commercial	0	+70	°C
Industrial	-40	+85	°C

Electrical Characteristics (Notes 3, 4)

0°C ≤ T_A ≤ +70°C, 4.75V < V_{CC} < 5.25V unless otherwise specified

Symbol	Parameter	Conditions	Min	Typ	Max	Units	
V_{OD1}	Differential Driver Output Voltage (Unloaded)	$I_O = 0$			5	V	
V_{OD2}	Differential Driver Output Voltage (with Load)	(Figure 1) R = 50Ω; (RS-422) (Note 6)	2			V	
		R = 27Ω; (RS-485)	1.5			V	
ΔV_{OD}	Change in Magnitude of Driver Differential Output Voltage for Complementary Output States	(Figure 1) R = 27Ω			0.2	V	
V_{OC}	Driver Common Mode Output Voltage				3.0	V	
$\Delta V_{OCl} $	Change in Magnitude of Driver Common Mode Output Voltage for Complementary Output States				0.2	V	
V_{IH}	Input High Voltage	DI, DE, \overline{RE} , E, \overline{RE}/DE	2			V	
V_{IL}	Input Low Voltage				0.8	V	
V_{CL}	Input Clamp Voltage		$I_{IN} = -18$ mA			-1.5	V
I_{IL}	Input Low Current		$V_{IL} = 0.4$ V			-200	μA
I_{IH}	Input High Current		$V_{IH} = 2.4$ V			20	μA
I_{IN}	Input Current	DO/RI, $\overline{DO}/\overline{RI}$	$V_{CC} = 0$ V or 5.25V			+1.0	mA
		RI, \overline{RI}	\overline{RE}/DE or DE = 0V			-0.8	mA
I_{OZD}	TRI-STATE Current DS3697 & DS3698	DO, \overline{DO}	$V_{CC} = 0$ V or 5.25V, E = 0V			±100	μA
V_{TH}	Differential Input Threshold Voltage for Receiver		-7V ≤ V_{CM} ≤ +12V	-0.2		+0.2	V
ΔV_{TH}	Receiver Input Hysteresis		$V_{CM} = 0$ V		70	mV	
V_{OH}	Receiver Output High Voltage		$I_{OH} = -400$ μA	2.4		V	
V_{OL}	Output Low Voltage	RO	$I_{OL} = 16$ mA (Note 6)			0.5	V
		\overline{TS}	$I_{OL} = 8$ mA			0.45	V
I_{OZR}	OFF-State (High Impedance) Output Current at Receiver		$V_{CC} = \text{Max}$ 0.4V ≤ V_O ≤ 2.4V			±20	μA
R_{IN}	Receiver Input Resistance		-7V ≤ V_{CM} ≤ +12V	12		kΩ	

Electrical Characteristics (Notes 3, 4) (Continued)

0°C ≤ T_A ≤ +70°C, 4.75V < V_{CC} < 5.25V unless otherwise specified

Symbol	Parameter	Conditions	Min	Typ	Max	Units
I _{CC}	Supply Current	No Load (Note 6)		42	60	mA
		Driver Outputs Enabled				
I _{OSD}	Driver Short-Circuit Output Current	V _O = -7V (Note 6)			-250	mA
		V _O = +12V (Note 6)			+250	
I _{OSR}	Receiver Short-Circuit Output Current	V _O = 0V	-15		-85	mA

Note 2: "Absolute Maximum Ratings" are those beyond which the safety of the device cannot be guaranteed. They are not meant to imply that the device should be operated at these limits. The tables of "Electrical Characteristics" provide conditions for actual device operation.

Note 3: All currents into device pins are positive; all currents out of device pins are negative. All voltages are referenced to device ground unless otherwise specified.

Note 4: All typicals are given for V_{CC} = 5V and T_A = 25°C.

Note 5: Derate linearly at 11.1 mW/°C to 570 mW at 70°C.

Note 6: All limits for which Note 5 is applied must be derated by 10% for DS3695T and DS3696T. Other parameters remain the same for this extended temperature range device (-40°C ≤ T_A ≤ +85°C).

Switching Characteristics (Notes 4, 7) 0°C ≤ T_A ≤ +70°C, 4.75V < V_{CC} < 5.25V unless otherwise specified

Receiver Switching Characteristics

(Figures 2, 3, 4)

Symbol	Conditions	Min	Typ	Max	Units
t _{PLH}	C _L = 15 pF S1 and S2	15	25	37	ns
t _{PHL}		15	25	37	
t _{PLH} - t _{PHL}	Closed	0			ns
t _{PLZ}	C _L = 15 pF, S2 Open	5	12	16	ns
t _{PHZ}	C _L = 15 pF, S1 Open	5	12	16	ns
t _{PZL}	C _L = 15 pF, S2 Open	7	15	20	ns
t _{PZH}	C _L = 15 pF, S1 Open	7	15	20	ns

Driver Switching Characteristics

Symbol	Conditions	Min	Typ	Max	Units
SINGLE ENDED CHARACTERISTICS (Figures 5, 6, 7)					
t _{PLH}	R _L DIFF = 60Ω	9	15	22	ns
t _{PHL}	C _{L1} = C _{L2} = 100 pF	9	15	22	
t _{SKEW} t _{PLH} - t _{PHL}			2	8	ns
t _{PLZ}	C _L = 15 pF, S2 Open	7	15	30	ns
t _{PHZ}	C _L = 15 pF, S1 Open	7	15	30	ns
t _{PZL}	C _L = 100 pF, S2 Open	30	35	50	ns
t _{PZH}	C _L = 100 pF, S1 Open	30	35	50	ns
DIFFERENTIAL CHARACTERISTICS (Figures 5, 8)					
t _r , t _f	R _L DIFF = 60Ω C _{L1} = C _{L2} = 100 pF	6	10	18	ns

Note 7: Switching Characteristics apply for DS3695, DS3695T, DS3696, DS3697 only.

AC Test Circuits and Switching Waveforms

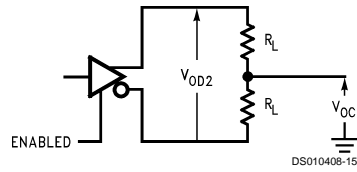

FIGURE 1. Driver V_{OD} and V_{OC}

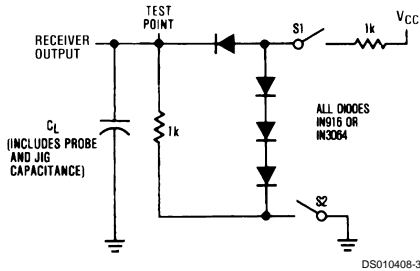
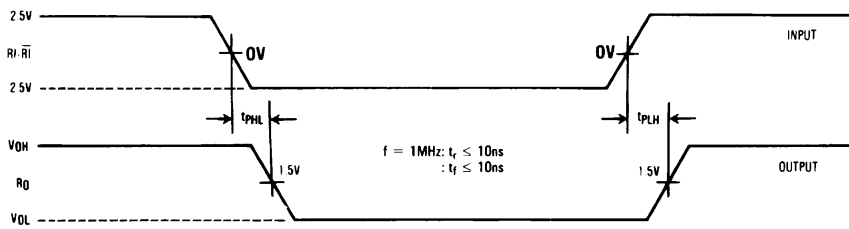

FIGURE 2. Receiver Propagation Delay Test Circuit



Note: Differential input voltage may be realized by grounding \overline{RI} and pulsing RI between +2.5V and -2.5V.

FIGURE 3. Receiver Input-to-Output Propagation Delay Timing

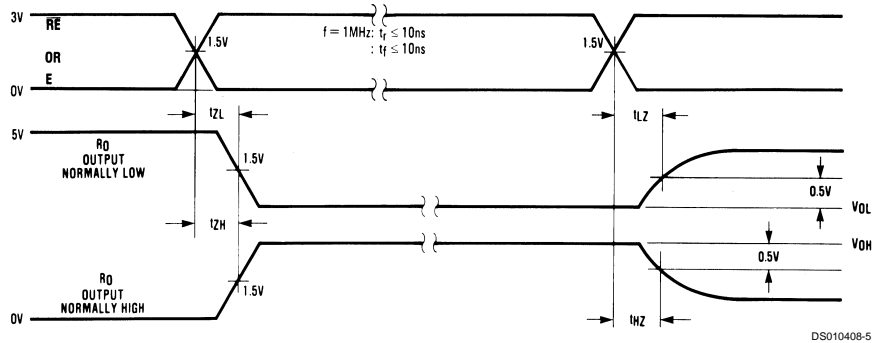
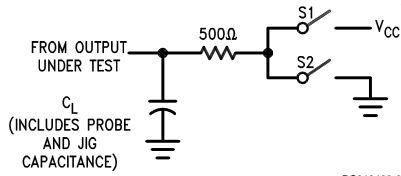
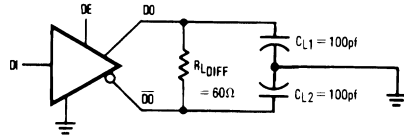

FIGURE 4. Receiver Enable/Disable Propagation Delay Timing

AC Test Circuits and Switching Waveforms (Continued)



DS010408-6



DS010408-7

Note: Unless otherwise specified the switches are closed.

FIGURE 5. Driver Propagation Delay and Transition Time Test Circuits

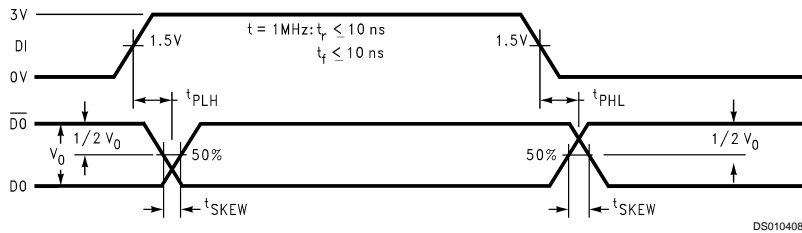

DS010408-8

Note: t_{PLH} and t_{PHL} are measured to the respective 50% points. t_{SKEW} is the difference between propagation delays of the complementary outputs.

FIGURE 6. Driver Input-to-Output Propagation Delay Timing (Single-Ended)

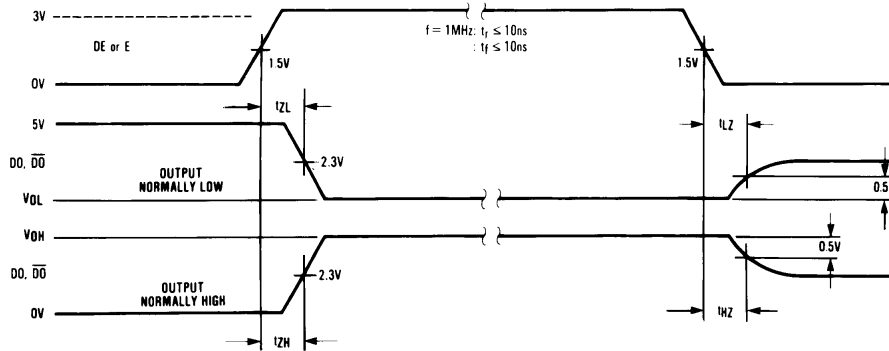

DS010408-9

FIGURE 7. Driver Enable/Disable Propagation Delay Timing

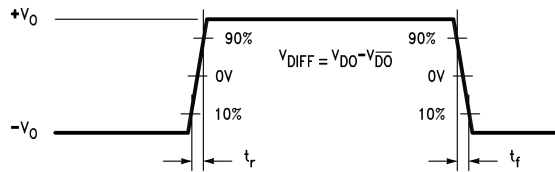

DS010408-10

FIGURE 8. Driver Differential Transition Timing

Function Tables

DS3695/DS3696 Transmitting

Inputs			Thermal Shutdown	Outputs		
\overline{RE}	DE	DI		\overline{DO}	DO	\overline{TS}^* (DS3696 Only)
X	1	1	OFF	0	1	H
X	1	0	OFF	1	0	H
X	0	X	OFF	Z	Z	H
X	1	X	ON	Z	Z	L

DS3695/DS3696 Receiving

Inputs			Outputs	
\overline{RE}	DE	$RI-\overline{RI}$	RO	\overline{TS}^* (DS3696 Only)
0	0	$\geq +0.2V$	1	H
0	0	$\leq -0.2V$	0	H
1	0	X	Z	H

DS3697

Inputs		Thermal Shutdown	Outputs		
E	$RI-\overline{RI}$		\overline{DO}	DO	RO (DS3697 Only)
1	$\geq +0.2V$	OFF	0	1	1
1	$\leq -0.2V$	OFF	1	0	0
0	X	OFF	Z	Z	Z
1	$\geq +0.2V$	ON	Z	Z	1
1	$\leq -0.2V$	ON	Z	Z	0

X— Don't care condition
Z— High impedance state

* \overline{TS} is an "open collector" output with an on-chip 10 k Ω pull-up resistor that reports the occurrence of a thermal shutdown of the device.

Typical Application

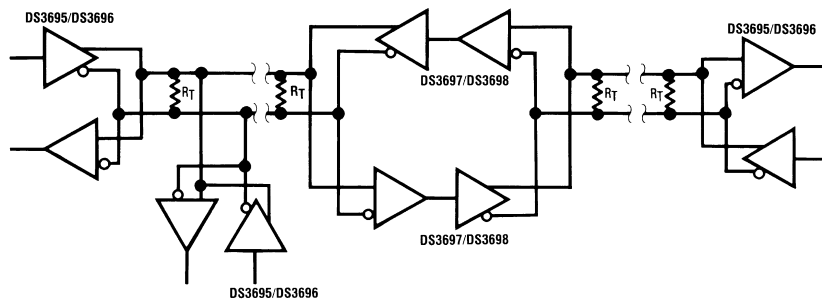

Note: Repeater control logic not shown, see AN-702.

DS010408-11

Typical Performance Characteristics

Driver V_{OH} vs I_{OH} vs Temperature

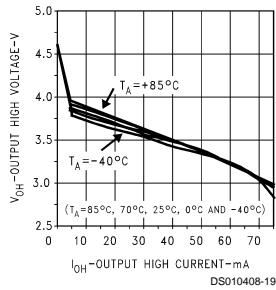

Driver V_{OH} vs I_{OH} vs V_{CC} Driver V_{OH} vs I_{OH} vs V_{CC}

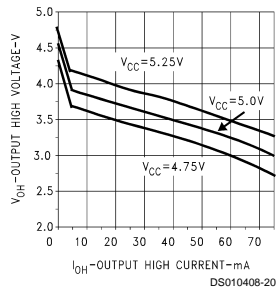

Driver V_{OL} vs I_{OL} vs Temperature

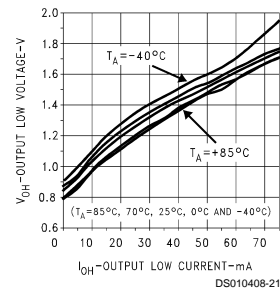

Driver V_{OL} vs I_{OL} vs V_{CC}

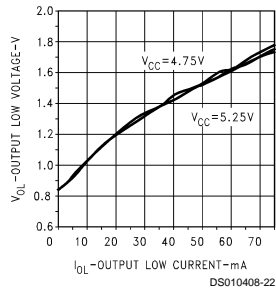

Driver Differential Propagation Delay vs Temperature

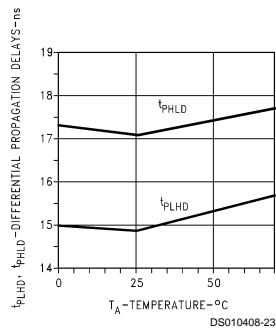

Driver Differential Propagation Delay vs V_{CC}

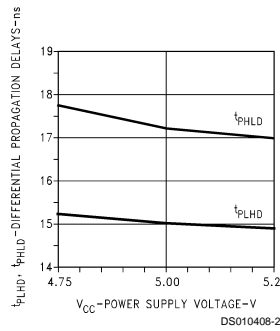

Driver Single-Ended Propagation Delay vs Temperature

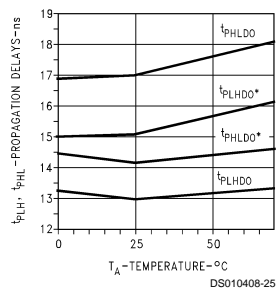

Driver Single-Ended Propagation Delay vs V_{CC}

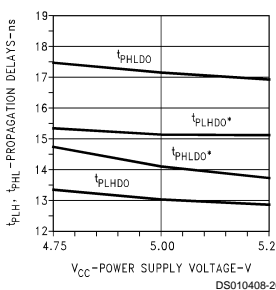

Driver Transition Time vs Temperature

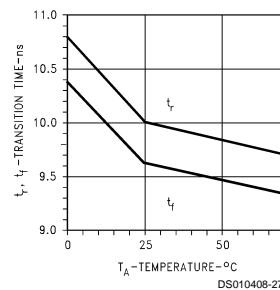

Typical Performance Characteristics (Continued)

Driver Transition Time vs V_{CC}

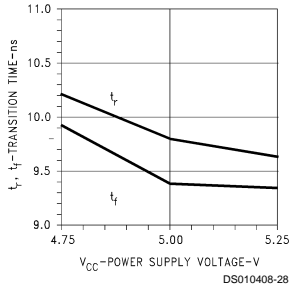

Cable Length vs Data Rate

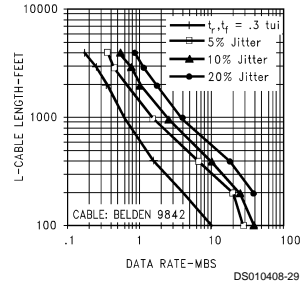

Supply Current vs Temperature

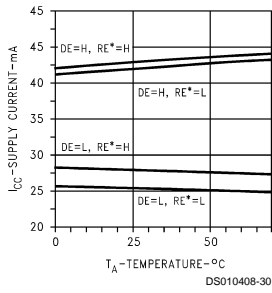

Supply Current vs Power Supply Voltage

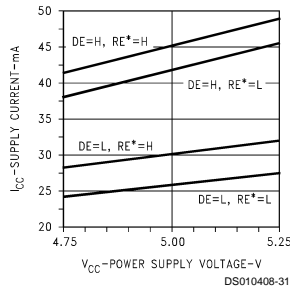

Driver I_{CC} vs Switching Frequency

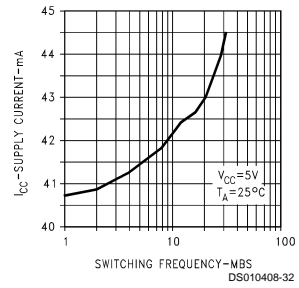

Driver Short Circuit Current vs Temperature

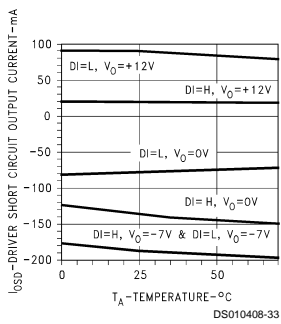

Receiver V_{OH} vs I_{OH} vs Temperature

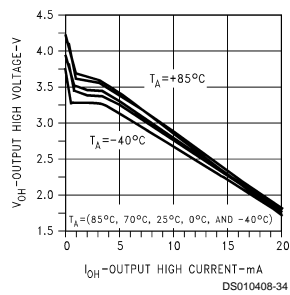

Receiver V_{OH} vs I_{OH} vs V_{CC}

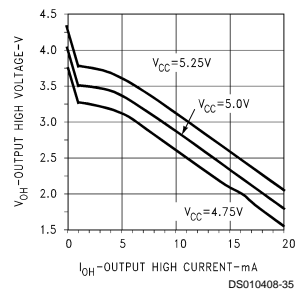

Typical Performance Characteristics (Continued)

Receiver V_{OL} vs I_{OL} vs Temperature

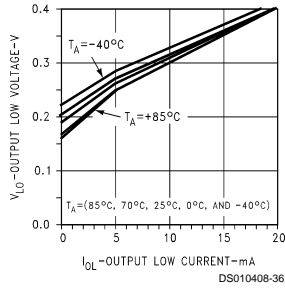

Receiver V_{OL} vs I_{OL} vs V_{CC}

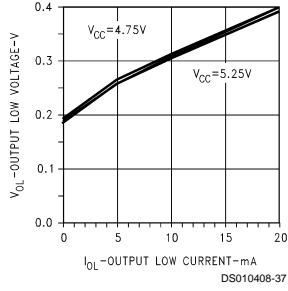

Receiver Differential Propagation Delay vs Temperature

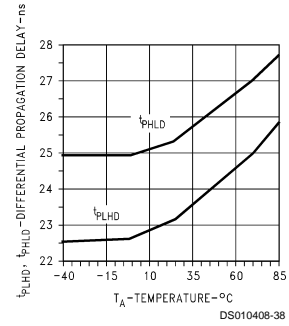

Receiver Differential Propagation Delay vs V_{CC}

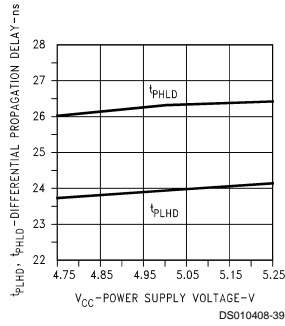

Receiver Short Circuit Current vs Temperature

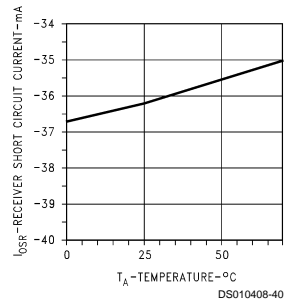

Receiver Short Circuit Current vs Power Supply

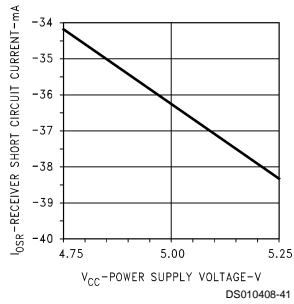

Receiver Non-Inverting Input Current vs Temperature

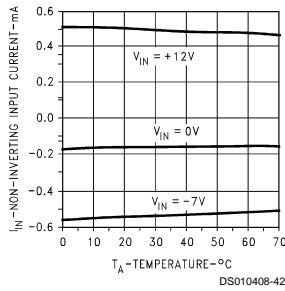

Receiver Non-Inverting Input Current vs Power Supply Voltage

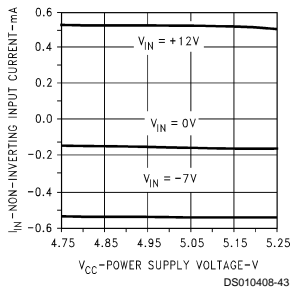

Receiver Inverting Input Current vs Temperature

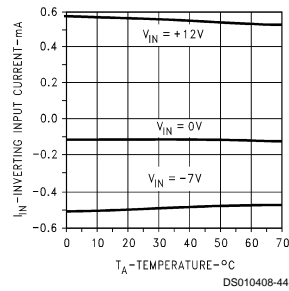

Typical Performance Characteristics (Continued)

Receiver Inverting Input Current vs Power Supply Voltage

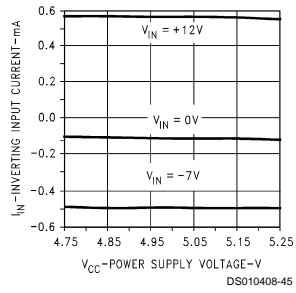

Hysteresis and Differential Transition Voltage vs Temperature

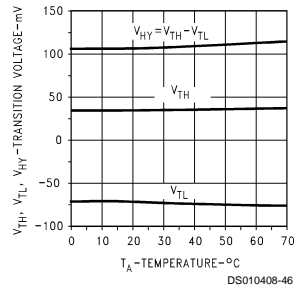

Hysteresis and Differential Transition Voltage vs V_{CC}

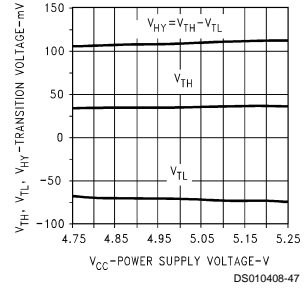



Physical Dimensions inches (millimeters) unless otherwise noted

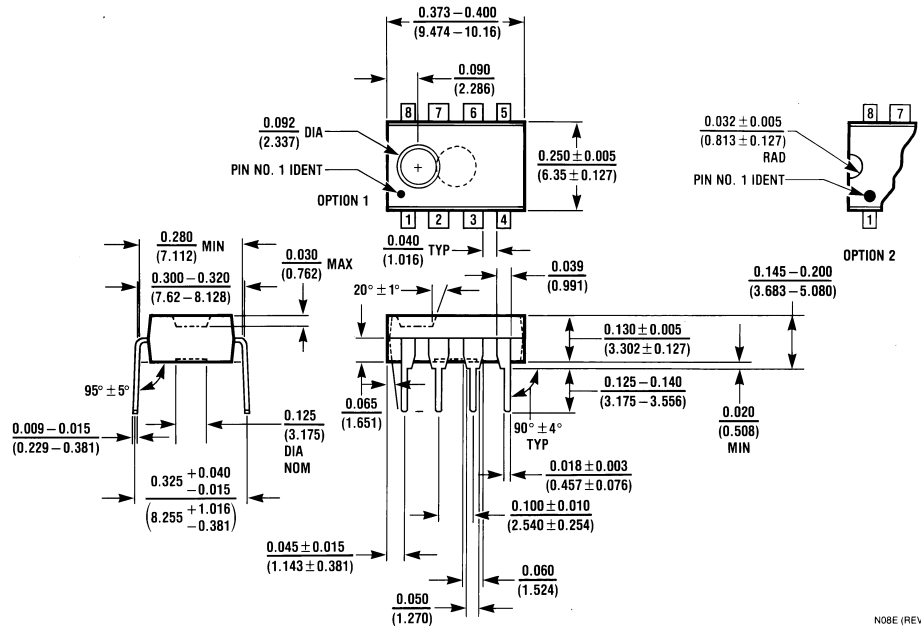

8-Lead Molded Dual-In-Line Package (N)
 Order Number DS3695N, DS3696N, DS3697N, or DS3695TN
 NS Package Number N08E

N08E (REV F)

LIFE SUPPORT POLICY

NATIONAL'S PRODUCTS ARE NOT AUTHORIZED FOR USE AS CRITICAL COMPONENTS IN LIFE SUPPORT DEVICES OR SYSTEMS WITHOUT THE EXPRESS WRITTEN APPROVAL OF THE PRESIDENT OF NATIONAL SEMICONDUCTOR CORPORATION. As used herein:

1. Life support devices or systems are devices or systems which, (a) are intended for surgical implant into the body, or (b) support or sustain life, and whose failure to perform when properly used in accordance with instructions for use provided in the labeling, can be reasonably expected to result in a significant injury to the user.
2. A critical component in any component of a life support device or system whose failure to perform can be reasonably expected to cause the failure of the life support device or system, or to affect its safety or effectiveness.



National Semiconductor Corporation
 Americas
 Tel: 1-800-272-9959
 Fax: 1-800-737-7018
 Email: support@nsc.com

National Semiconductor Europe
 Fax: +49 (0) 1 80-530 85 86
 Email: europe.support@nsc.com
 Deutsch Tel: +49 (0) 1 80-530 85 85
 English Tel: +49 (0) 1 80-532 78 32
 Français Tel: +49 (0) 1 80-532 93 58
 Italiano Tel: +49 (0) 1 80-534 16 80

National Semiconductor Asia Pacific Customer Response Group
 Tel: 65-2544466
 Fax: 65-2504466
 Email: sea.support@nsc.com

National Semiconductor Japan Ltd.
 Tel: 81-3-5620-6175
 Fax: 81-3-5620-6179

www.national.com