



Heterojunction Bipolar Transistor Technology (InGaP HBT)

High Efficiency/Linearity Amplifier

The MMZ09312B is a 2-stage high efficiency, Class AB InGaP HBT amplifier designed for use as a linear driver amplifier in wireless base station applications as well as an output stage in femtocell or repeater applications. It is suitable for applications with frequencies from 400 to 1000 MHz such as CDMA, GSM, LTE and ZigBee® at operating voltages from 3 to 5 Volts.

- Typical Performance: $V_{CC1} = V_{CC2} = V_{BIAS} = 5$ Vdc, $I_{CQ} = 74$ mA

Frequency	P _{out} (dBm)	G _{ps} (dB)	ACPR (dBc)	PAE (%)	Test Signal
900 MHz	24	31.5	-50.0	26.0	IS-95 CDMA
900 MHz	18.0	31.5	-50.0	10.8	1C W-CDMA TM1
900 MHz	17.0	31.5	-50.0	9.0	10 MHz LTE TM1.1
750 MHz	17.5	32.0	-50.0	15.3	LTE 10/20 MHz
450 MHz	29	33.0	-40.0	57.0	ZigBee

MMZ09312BT1

**400-1000 MHz, 31.7 dB
29.6 dBm
InGaP HBT LINEAR AMPLIFIER**



QFN 3 x 3

Features

- Frequency: 400-1000 MHz
- P1dB: 29.6 dBm @ 900 MHz
- Power Gain: 31.7 dB @ 900 MHz
- OIP3: 42 dBm @ 900 MHz
- Active Bias Control (adjustable externally)
- Single 3 to 5 V Supply
- Performs Well with Digital Predistortion Systems
- Single-ended Power Detector
- Cost-effective 12-pin, 3 mm QFN Surface Mount Package
- In Tape and Reel. T1 Suffix = 1,000 Units, 12 mm Tape Width, 7-inch Reel.

Table 1. Typical Performance (1)

Characteristic	Symbol	450 MHz	900 MHz	Unit
Small-Signal Gain (S21)	G _p	33.8	31.7	dB
Input Return Loss (S11)	IRL	-22	-15	dB
Output Return Loss (S22)	ORL	-25	-18	dB
Power Output @ 1dB Compression	P1dB	28.8	29.6	dBm

1. $V_{CC1} = V_{CC2} = V_{BIAS} = 5$ Vdc, $T_A = 25^\circ\text{C}$, 50 ohm system, CW Application Circuit

Table 2. Maximum Ratings

Rating	Symbol	Value	Unit
Supply Voltage	V_{CC}	6	V
Supply Current	I_{CC}	550	mA
RF Input Power	P_{in}	14	dBm
Storage Temperature Range	T_{stg}	-65 to +150	$^\circ\text{C}$
Junction Temperature	T_J	175	$^\circ\text{C}$

Table 3. Thermal Characteristics

Characteristic	Symbol	Value (2)	Unit
Thermal Resistance, Junction to Case Case Temperature 84°C , $V_{CC1} = V_{CC2} = V_{BIAS} = 5$ Vdc	$R_{\theta JC}$	56	$^\circ\text{C/W}$

2. Refer to AN1955, *Thermal Measurement Methodology of RF Power Amplifiers*. Go to <http://www.freescale.com/rf>. Select Documentation/Application Notes - AN1955.

Table 4. Electrical Characteristics ($V_{CC1} = V_{CC2} = V_{BIAS} = 5$ Vdc, 900 MHz, $T_A = 25^\circ\text{C}$, 50 ohm system, in Freescale CW Application Circuit)

Characteristic	Symbol	Min	Typ	Max	Unit
Small-Signal Gain (S21)	G_p	29	31.7	—	dB
Input Return Loss (S11)	IRL	—	-15	—	dB
Output Return Loss (S22)	ORL	—	-18	—	dB
Power Output @ 1dB Compression	P1dB	—	29.6	—	dBm
Third Order Output Intercept Point, Two-Tone CW	OIP3	—	42	—	dBm
Noise Figure	NF	—	4	—	dB
Supply Current	I_{CQ}	69	74	83	mA
Supply Voltage	V_{CC}	—	5	—	V

Table 5. ESD Protection Characteristics

Test Methodology	Class
Human Body Model (per JESD22-A114)	Meets 2000 V for all pins except: Pin 11 meets 400 V Pin 8 meets 200 V Class 0 Rating
Machine Model (per EIA/JESD22-A115)	A
Charge Device Model (per JESD22-C101)	IV

Table 6. Moisture Sensitivity Level

Test Methodology	Rating	Package Peak Temperature	Unit
Per JESD22-A113, IPC/JEDEC J-STD-020	1	260	$^\circ\text{C}$

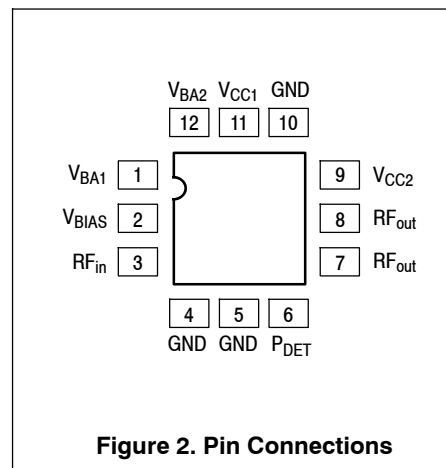
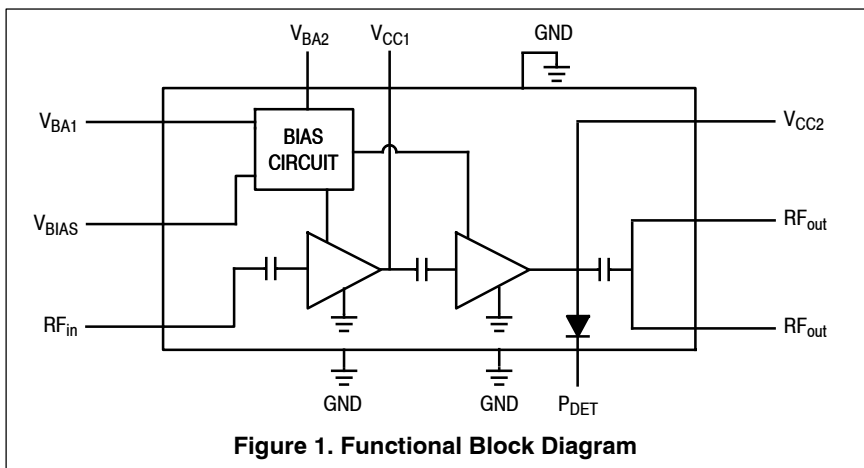

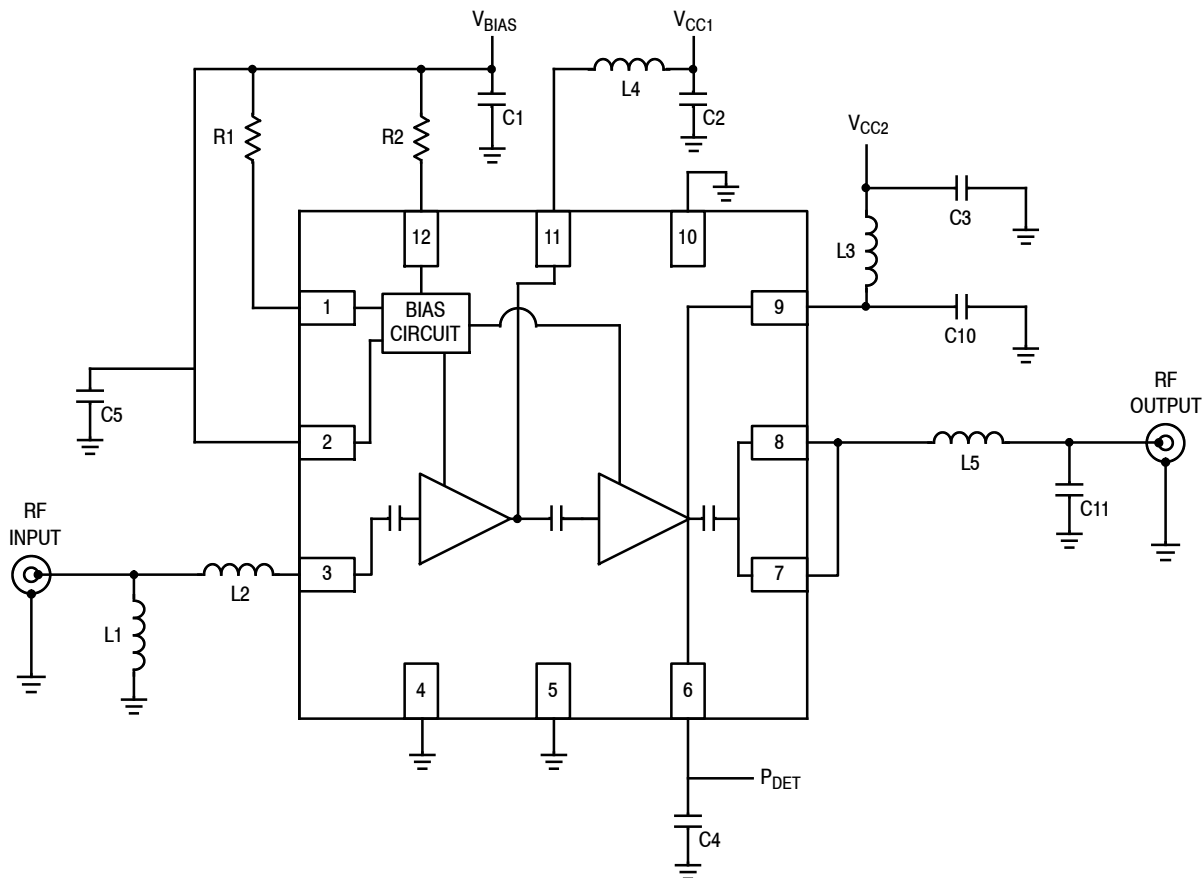
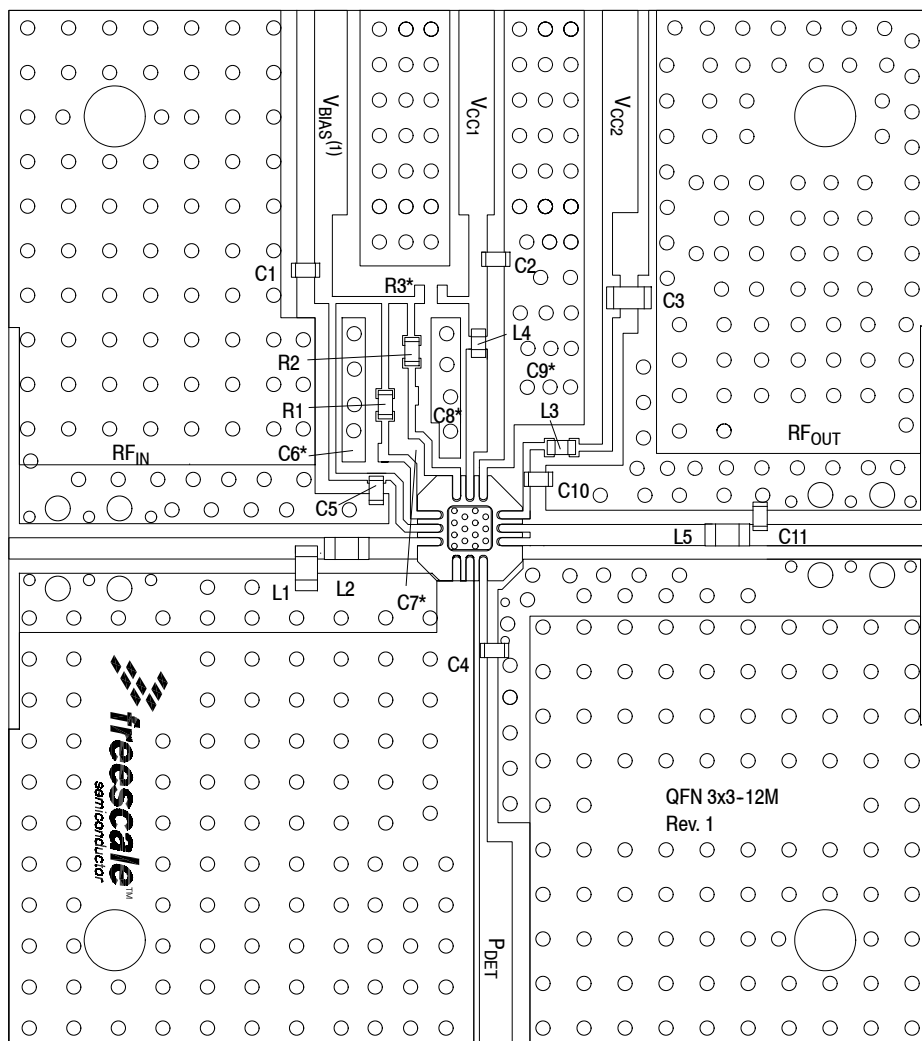

Figure 3. MMZ09312B Test Circuit Schematic — CDMA IS-95, 900 MHz, 5.0 V

Table 7. MMZ09312B Test Circuit Component Designations and Values — CDMA IS-95, 900 MHz, 5.0 V

Part	Description	Part Number	Manufacturer
C1, C2	1 μ F Chip Capacitors	GRM155R61A105KE15	Murata
C3	4.7 μ F Chip Capacitor	GRM188R60J475KE19	Murata
C4	470 pF Chip Capacitor	GRM1555C1H471JA01	Murata
C5	100 pF Chip Capacitor	GRM1555C1H101JA01	Murata
C6, C7, C8, C9	Components Not Placed		
C10	4.7 pF Chip Capacitor	04023J4R7BBSTR	AVX
C11	6.8 pF Chip Capacitor	04023J6R8BBSTR	AVX
L1	8.2 nH Chip Inductor	LL1608-FSL8N2JL	TOKO
L2	1.2 nH Chip Inductor	LL1608-FSL1N2S	TOKO
L3	33 nH Chip Inductor	0402CS-33NXGLW	Coilcraft
L4	22 nH Chip Inductor	0402CS-22NXGLW	Coilcraft
L5	3.3 nH Chip Inductor	0603CS-3N3XJLW	Coilcraft
R1	330 Ω , 1/16 W Chip Resistor	RC0402JR-07331RL	Yageo
R2	1.5 k Ω , 1/16 W Chip Resistor	RC0402JR-07152RL	Yageo
R3	Component Not Placed		
PCB	0.014", $\epsilon_r = 3.7$	FR408	Isola

Note: Component numbers C6, C7, C8, C9 and R3 are labeled on board but not placed.



(1) VBIAS [Board] supplies VBA1, VBA2 and VBIAS [Device].

Note: Component numbers C6*, C7*, C8*, C9* and R3* are labeled on board but not placed.

Figure 4. MMZ09312B Test Circuit Component Layout — CDMA IS-95, 900 MHz, 5.0 V

Table 7. MMZ09312B Test Circuit Component Designations and Values — CDMA IS-95, 900 MHz, 5.0 V

Part	Description	Part Number	Manufacturer
C1, C2	1 μ F Chip Capacitors	GRM155R61A105KE15	Murata
C3	4.7 μ F Chip Capacitor	GRM188R60J475KE19	Murata
C4	470 pF Chip Capacitor	GRM1555C1H471JA01	Murata
C5	100 pF Chip Capacitor	GRM1555C1H101JA01	Murata
C6, C7, C8, C9	Components Not Placed		
C10	4.7 pF Chip Capacitor	04023J4R7BBSTR	AVX
C11	6.8 pF Chip Capacitor	04023J6R8BBSTR	AVX
L1	8.2 nH Chip Inductor	LL1608-FSL8N2JL	TOKO
L2	1.2 nH Chip Inductor	LL1608-FSL1N2S	TOKO
L3	33 nH Chip Inductor	0402CS-33NXGLW	Coilcraft
L4	22 nH Chip Inductor	0402CS-22NXGLW	Coilcraft
L5	3.3 nH Chip Inductor	0603CS-3N3XJLW	Coilcraft
R1	330 Ω , 1/16 W Chip Resistor	RC0402JR-07331RL	Yageo
R2	1.5 k Ω , 1/16 W Chip Resistor	RC0402JR-07152RL	Yageo
R3	Component Not Placed		
PCB	0.014", $\epsilon_r = 3.7$	FR408	Isola

(Test Circuit Component Designations and Values table repeated for reference.)

MMZ09312BT1

TYPICAL CHARACTERISTICS — CDMA IS-95, 900 MHz, 5.0 V

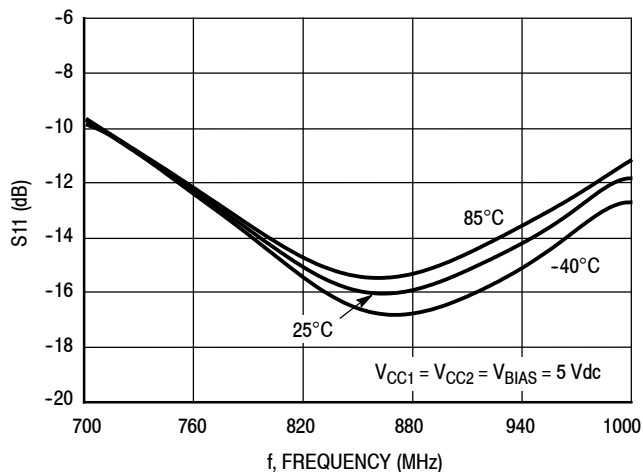

Figure 5. S11 versus Frequency versus Temperature

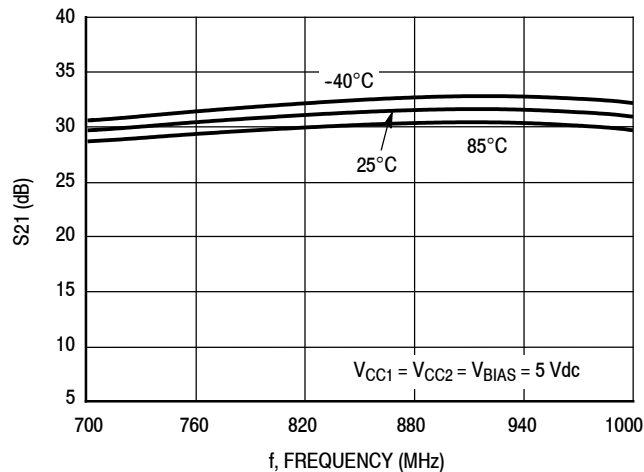

Figure 6. S21 versus Frequency versus Temperature

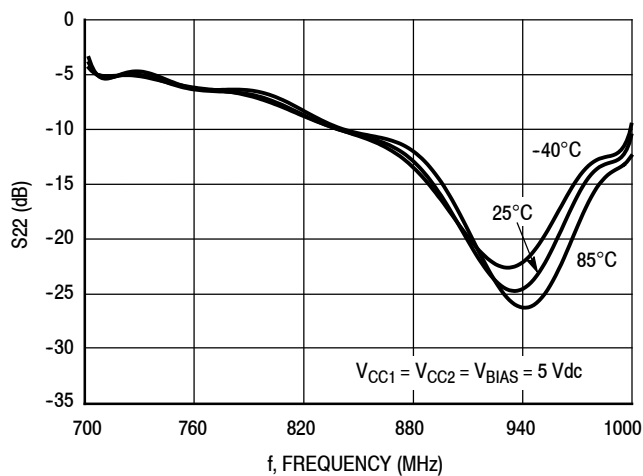

Figure 7. S22 versus Frequency versus Temperature

TYPICAL CHARACTERISTICS — CDMA IS-95, 900 MHz, 5.0 V

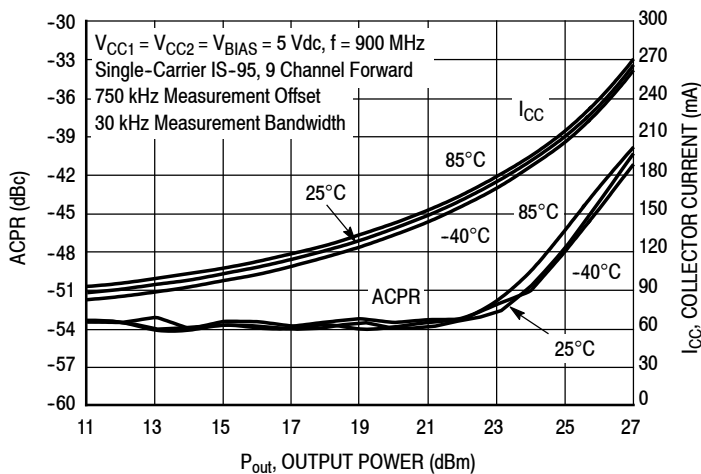

Figure 8. ACPR versus Collector Current versus Output Power versus Temperature

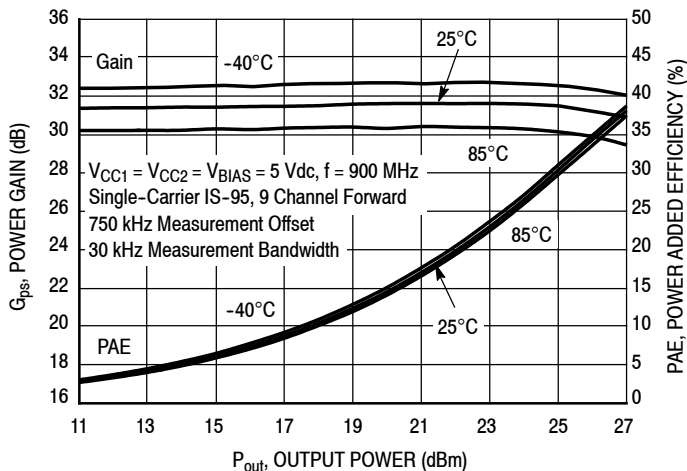

Figure 9. Power Gain versus Power Added Efficiency versus Output Power versus Temperature

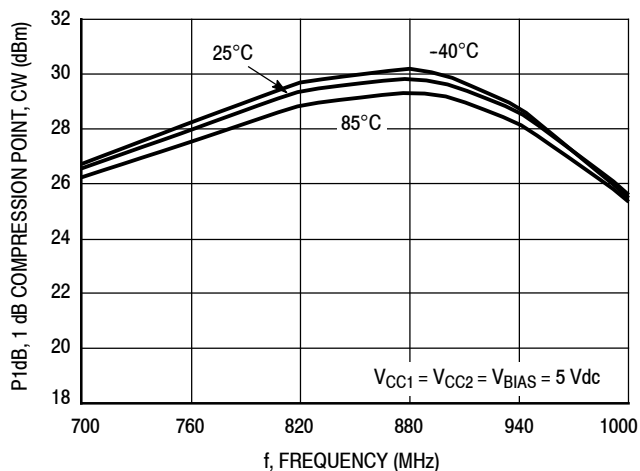

Figure 10. P1dB versus Frequency versus Temperature, CW

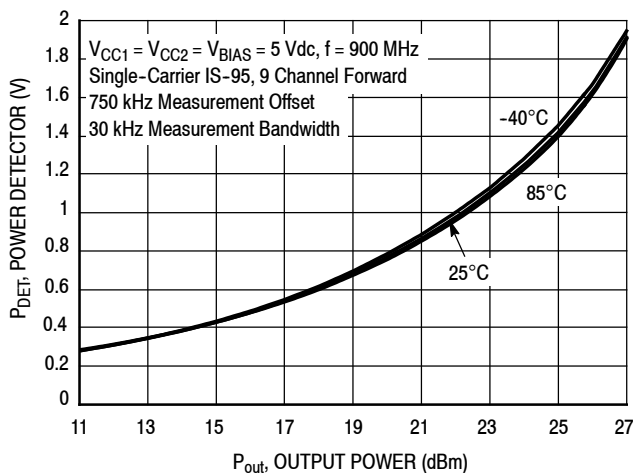

Figure 11. Power Detector versus Output Power versus Temperature

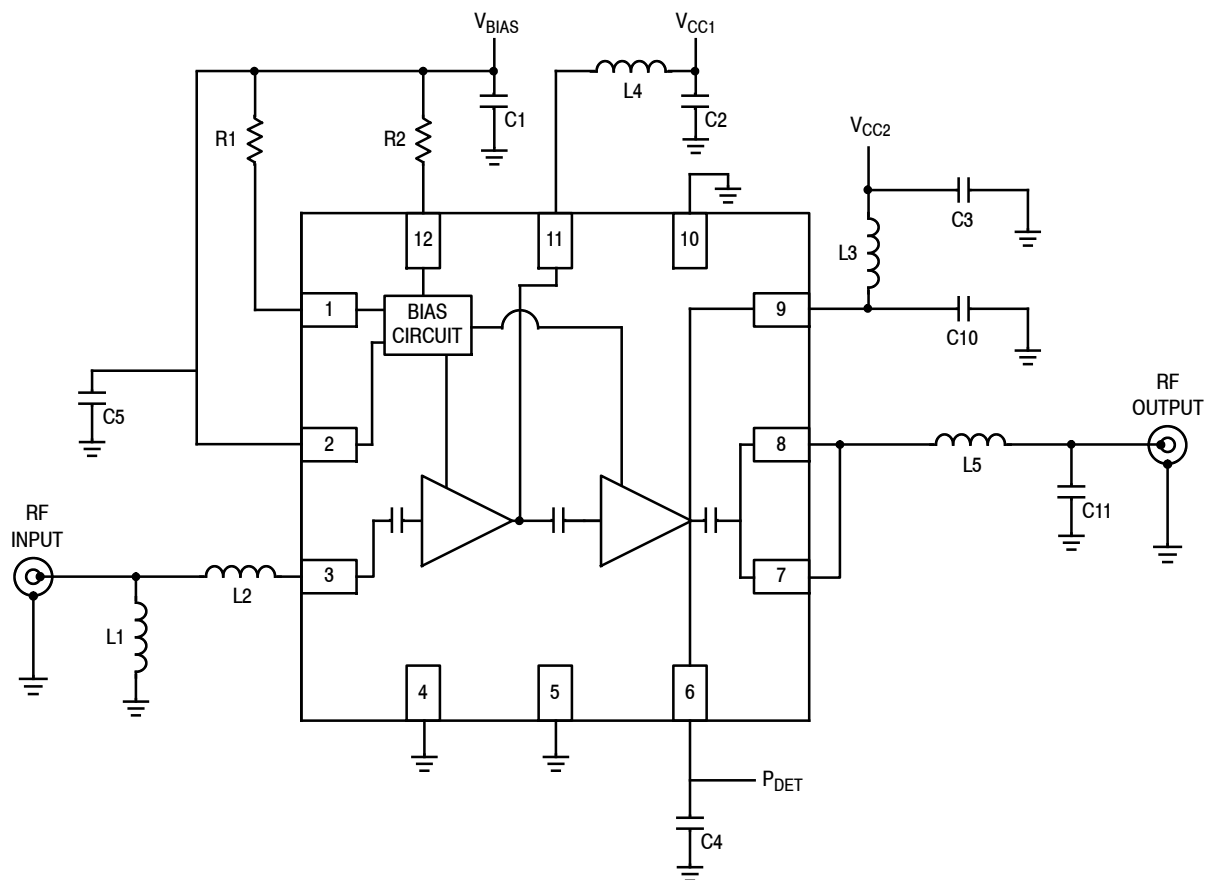
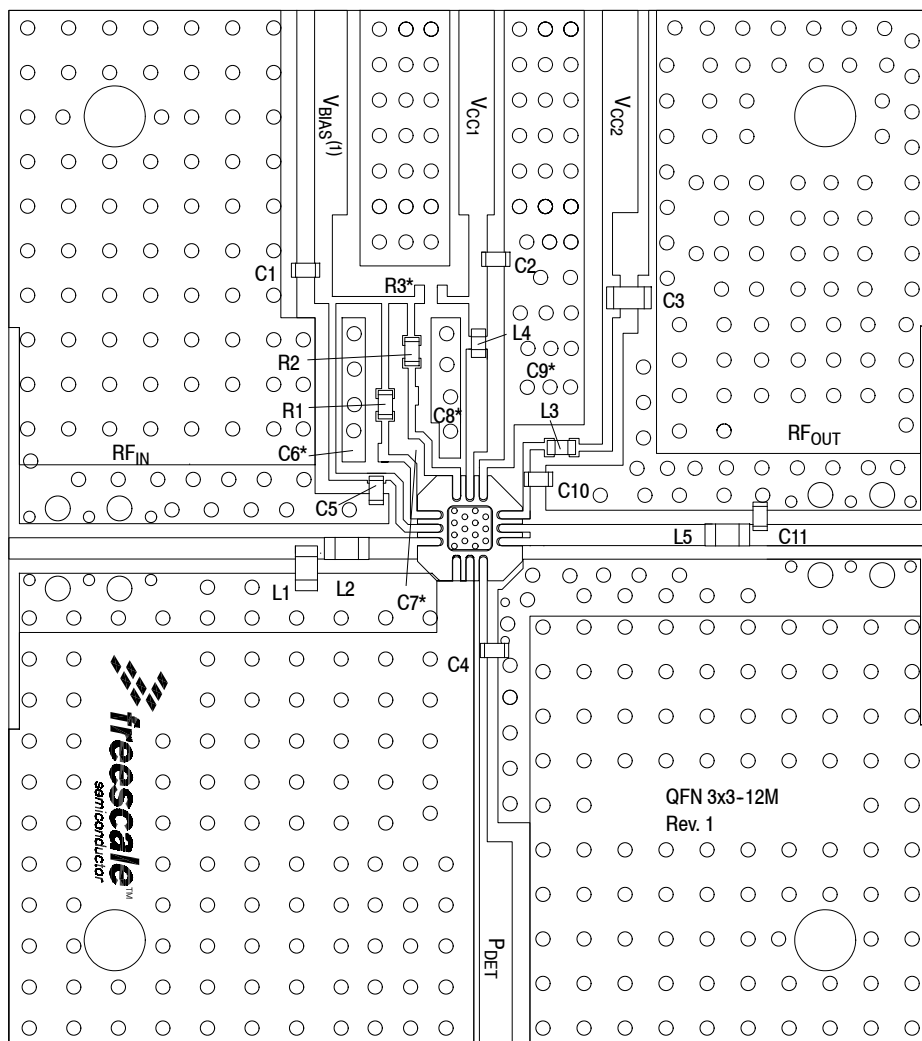

Figure 12. MMZ09312B Test Circuit Schematic — UMTS/LTE, 900 MHz, 5.0 V

Table 8. MMZ09312B Test Circuit Component Designations and Values — UMTS/LTE, 900 MHz, 5.0 V

Part	Description	Part Number	Manufacturer
C1, C2	1 μ F Chip Capacitors	GRM155R61A105KE15	Murata
C3	4.7 μ F Chip Capacitor	GRM188R60J475KE19	Murata
C4	470 pF Chip Capacitor	GRM1555C1H471JA01	Murata
C5	100 pF Chip Capacitor	GRM1555C1H101JA01	Murata
C6, C7, C8, C9	Components Not Placed		
C10	3.9 pF Chip Capacitor	04023J3R9BBSTR	AVX
C11	5.6 pF Chip Capacitor	04023J5R6BBSTR	AVX
L1	8.2 nH Chip Inductor	LL1608-FSL8N2JL	TOKO
L2	1.2 nH Chip Inductor	LL1608-FSL1N2S	TOKO
L3	33 nH Chip Inductor	0402CS-33NXGLW	Coilcraft
L4	22 nH Chip Inductor	0402CS-22NXGLW	Coilcraft
L5	3.3 nH Chip Inductor	0603CS-3N3XJLW	Coilcraft
R1	330 Ω , 1/16 W Chip Resistor	RC0402JR-07331RL	Yageo
R2	1.5 k Ω , 1/16 W Chip Resistor	RC0402JR-07152RL	Yageo
R3	Component Not Placed		
PCB	0.014", $\epsilon_r = 3.7$	FR408	Isola

Note: Component numbers C6, C7, C8, C9 and R3 are labeled on board but not placed.



(1) V_{BIAS} [Board] supplies V_{BA1}, V_{BA2} and V_{BIAS} [Device].

Note: Component numbers C6*, C7*, C8*, C9* and R3* are labeled on board but not placed.

Figure 13. MMZ09312B Test Circuit Component Layout — UMTS/LTE, 900 MHz, 5.0 V

Table 8. MMZ09312B Test Circuit Component Designations and Values — UMTS/LTE, 900 MHz, 5.0 V

Part	Description	Part Number	Manufacturer
C1, C2	1 μ F Chip Capacitors	GRM155R61A105KE15	Murata
C3	4.7 μ F Chip Capacitor	GRM188R60J475KE19	Murata
C4	470 pF Chip Capacitor	GRM1555C1H471JA01	Murata
C5	100 pF Chip Capacitor	GRM1555C1H101JA01	Murata
C6, C7, C8, C9	Components Not Placed		
C10	3.9 pF Chip Capacitor	04023J3R9BBSTR	AVX
C11	5.6 pF Chip Capacitor	04023J5R6BBSTR	AVX
L1	8.2 nH Chip Inductor	LL1608-FSL8N2JL	TOKO
L2	1.2 nH Chip Inductor	LL1608-FSL1N2S	TOKO
L3	33 nH Chip Inductor	0402CS-33NXGLW	Coilcraft
L4	22 nH Chip Inductor	0402CS-22NXGLW	Coilcraft
L5	3.3 nH Chip Inductor	0603CS-3N3XJLW	Coilcraft
R1	330 Ω , 1/16 W Chip Resistor	RC0402JR-07331RL	Yageo
R2	1.5 k Ω , 1/16 W Chip Resistor	RC0402JR-07152RL	Yageo
R3	Component Not Placed		
PCB	0.014", $\epsilon_r = 3.7$	FR408	Isola

(Test Circuit Component Designations and Values table repeated for reference.)

MMZ09312BT1

TYPICAL CHARACTERISTICS — UMTS/LTE, 900 MHz, 5.0 V

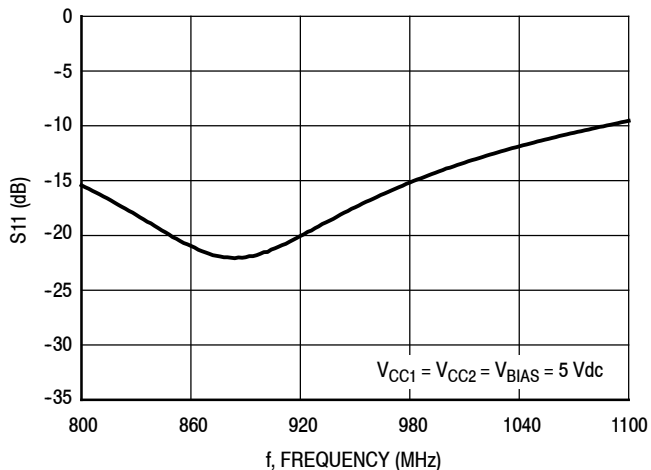

Figure 14. S11 versus Frequency

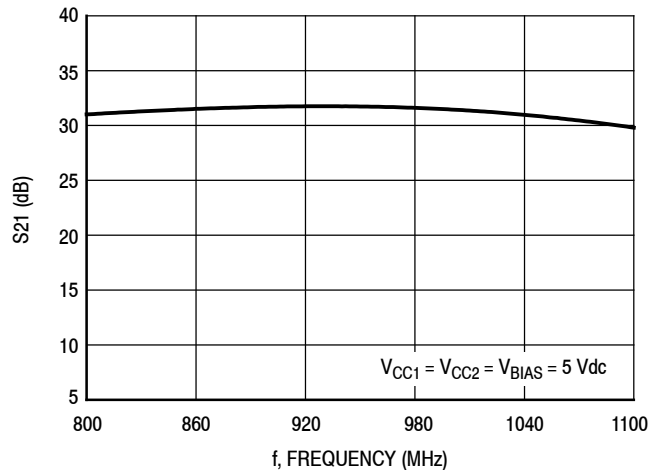

Figure 15. S21 versus Frequency

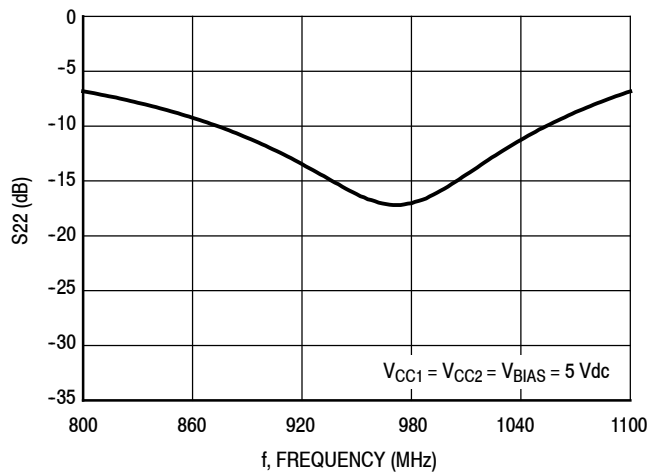

Figure 16. S22 versus Frequency

TYPICAL CHARACTERISTICS — UMTS/LTE, 900 MHz, 5.0 V

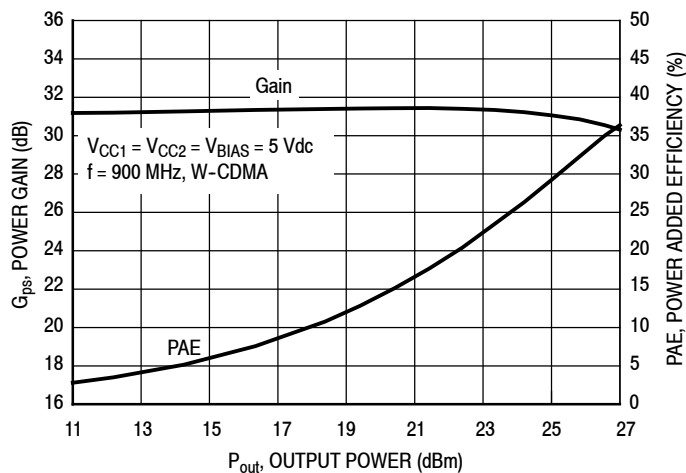

Figure 17. Power Gain and Power Added Efficiency versus Output Power

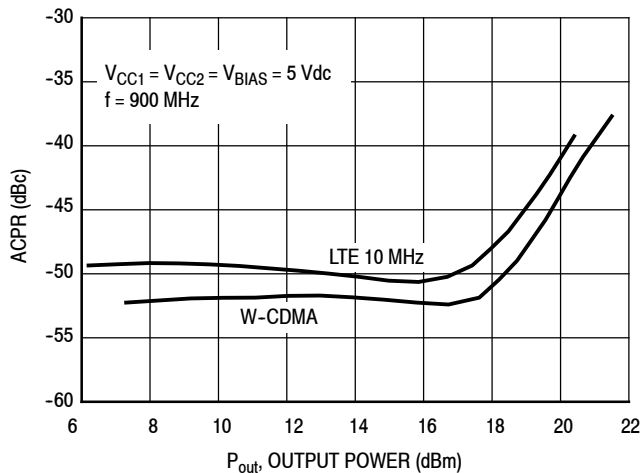

Figure 18. ACPR versus Output Power

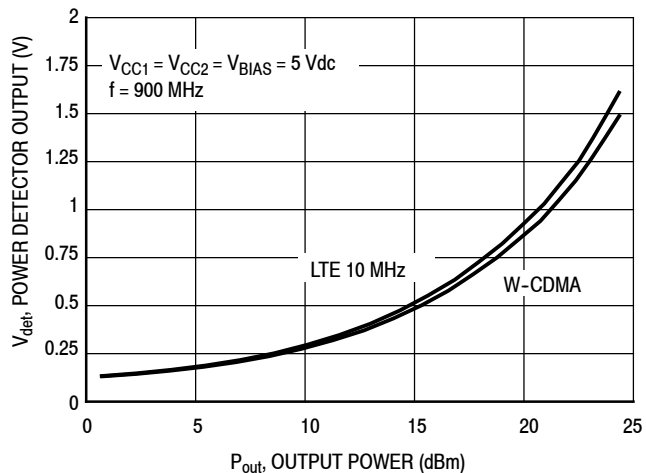

Figure 19. Power Detector Output versus Output Power

OPERATING CONDITIONS FOR FIGURES 17-19

W-CDMA

Single-Carrier W-CDMA 3GPP TM1
 CF = 9.31 dB, Channel Bandwidth = 3.84 MHz
 Adjacent Channel Bandwidth = 3.84 MHz
 Channel Offset = $\pm 5 \text{ MHz}$

LTE 10 MHz

LTE 10 MHz 3GPP TM1.1
 CF = 11.70 dB, Channel Bandwidth = 9 MHz
 Adjacent Channel Bandwidth = 9 MHz
 Channel Offset = $\pm 10 \text{ MHz}$

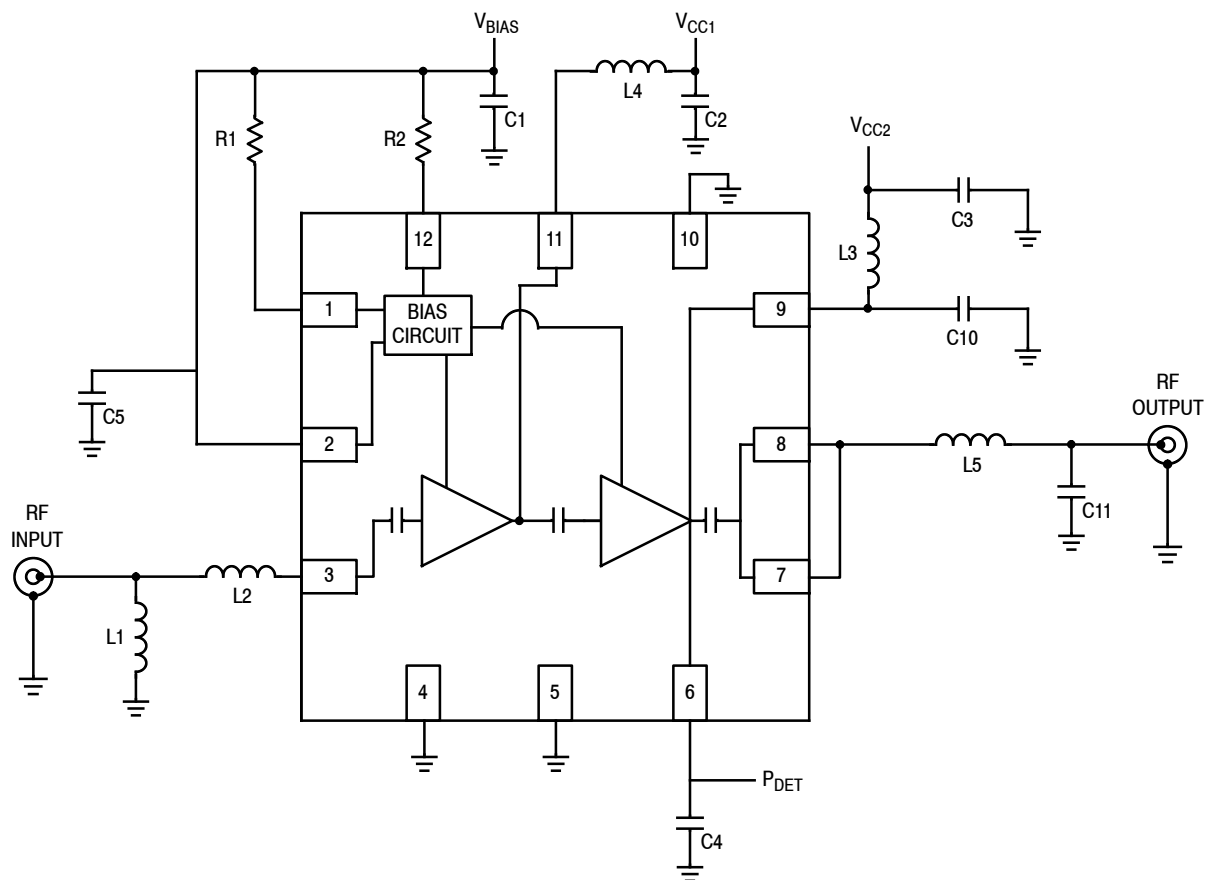
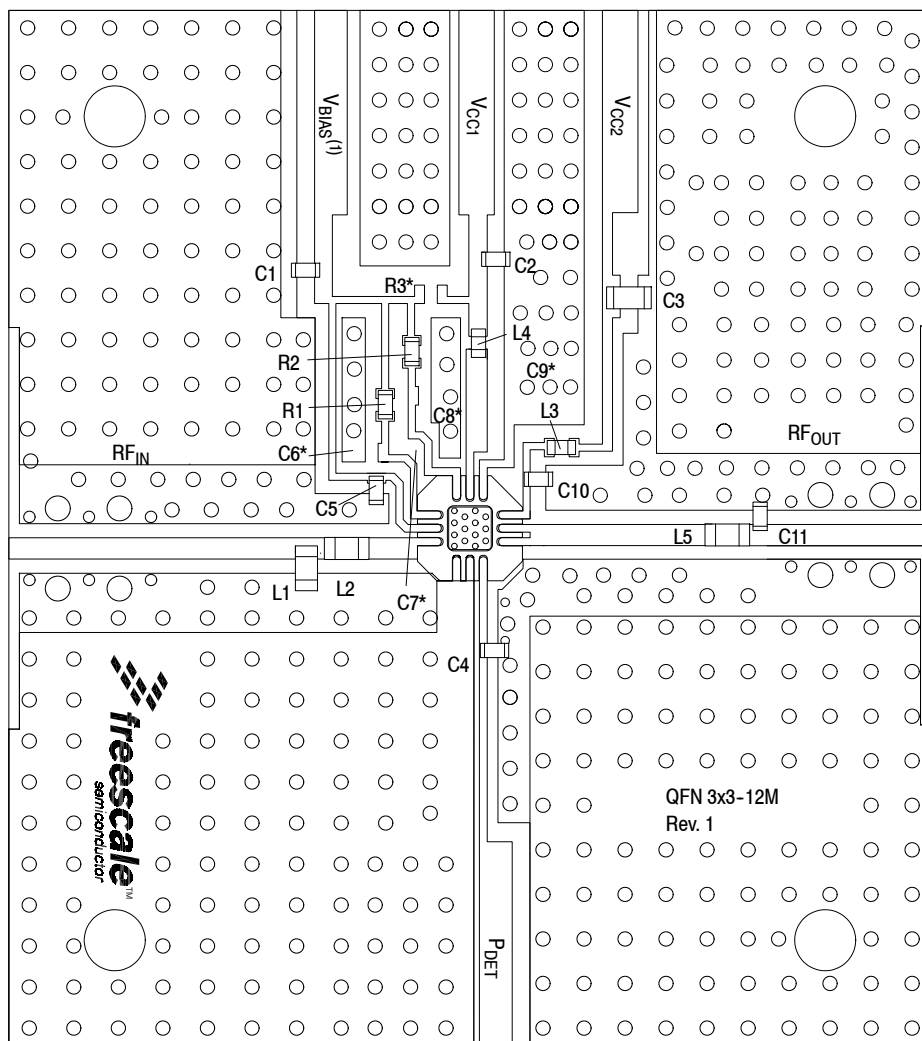

Figure 20. MMZ09312B Test Circuit Schematic — CDMA IS-95, 900 MHz, 3.3 V

Table 9. MMZ09312B Test Circuit Component Designations and Values — CDMA IS-95, 900 MHz, 3.3 V

Part	Description	Part Number	Manufacturer
C1, C2	1 μ F Chip Capacitors	GRM155R61A105KE15	Murata
C3	4.7 μ F Chip Capacitor	GRM188R60J475KE19	Murata
C4	470 pF Chip Capacitor	GRM1555C1H471JA01	Murata
C5	100 pF Chip Capacitor	GRM1555C1H101JA01	Murata
C6, C7, C8, C9	Components Not Placed		
C10	4.7 pF Chip Capacitor	04023J4R7BBSTR	AVX
C11	6.8 pF Chip Capacitor	04023J6R8BBSTR	AVX
L1	8.2 nH Chip Inductor	LL1608-FSL8N2JL	TOKO
L2	1.2 nH Chip Inductor	LL1608-FSL1N2S	TOKO
L3	33 nH Chip Inductor	0402CS-33NXGLW	Coilcraft
L4	22 nH Chip Inductor	0402CS-22NXGLW	Coilcraft
L5	3.3 nH Chip Inductor	0603CS-3N3XJLW	Coilcraft
R1	82 Ω , 1/16 W Chip Resistor	RC0402JR-07820RL	Yageo
R2	470 Ω , 1/16 W Chip Resistor	RC0402JR-07471RL	Yageo
R3	Component Not Placed		
PCB	0.014", $\epsilon_r = 3.7$	FR408	Isola

Note: Component numbers C6, C7, C8, C9 and R3 are labeled on board but not placed.



(1) V_{BIAS} [Board] supplies V_{BA1} , V_{BA2} and V_{BIAS} [Device].

Note: Component numbers C6*, C7*, C8*, C9* and R3* are labeled on board but not placed.

Figure 21. MMZ09312B Test Circuit Component Layout — CDMA IS-95, 900 MHz, 3.3 V

Table 9. MMZ09312B Test Circuit Component Designations and Values — CDMA IS-95, 900 MHz, 3.3 V

Part	Description	Part Number	Manufacturer
C1, C2	1 μ F Chip Capacitors	GRM155R61A105KE15	Murata
C3	4.7 μ F Chip Capacitor	GRM188R60J475KE19	Murata
C4	470 pF Chip Capacitor	GRM1555C1H471JA01	Murata
C5	100 pF Chip Capacitor	GRM1555C1H101JA01	Murata
C6, C7, C8, C9	Components Not Placed		
C10	4.7 pF Chip Capacitor	04023J4R7BBSTR	AVX
C11	6.8 pF Chip Capacitor	04023J6R8BBSTR	AVX
L1	8.2 nH Chip Inductor	LL1608-FSL8N2JL	TOKO
L2	1.2 nH Chip Inductor	LL1608-FSL1N2S	TOKO
L3	33 nH Chip Inductor	0402CS-33NXGLW	Coilcraft
L4	22 nH Chip Inductor	0402CS-22NXGLW	Coilcraft
L5	3.3 nH Chip Inductor	0603CS-3N3XJLW	Coilcraft
R1	82 Ω , 1/16 W Chip Resistor	RC0402JR-07820RL	Yageo
R2	470 Ω , 1/16 W Chip Resistor	RC0402JR-07471RL	Yageo
R3	Component Not Placed		
PCB	0.014", $\epsilon_r = 3.7$	FR408	Isola

(Test Circuit Component Designations and Values table repeated for reference.)

MMZ09312BT1

TYPICAL CHARACTERISTICS — CDMA IS-95, 900 MHz, 3.3 V

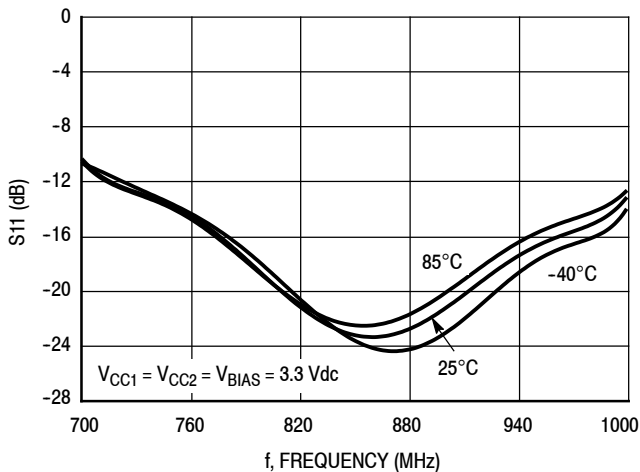

Figure 22. S11 versus Frequency versus Temperature

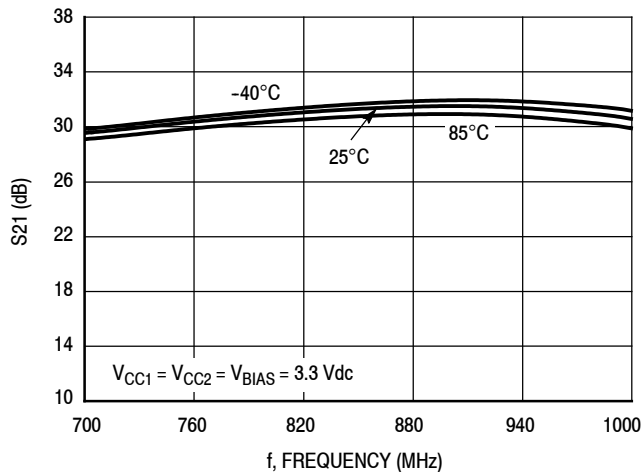

Figure 23. S21 versus Frequency versus Temperature

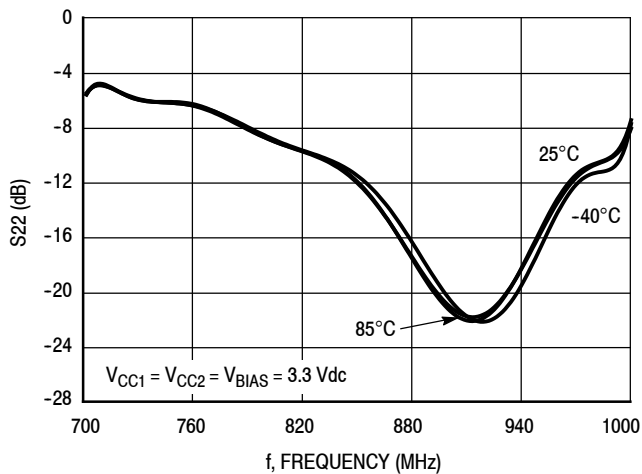

Figure 24. S22 versus Frequency versus Temperature

TYPICAL CHARACTERISTICS — CDMA IS-95, 900 MHz, 3.3 V

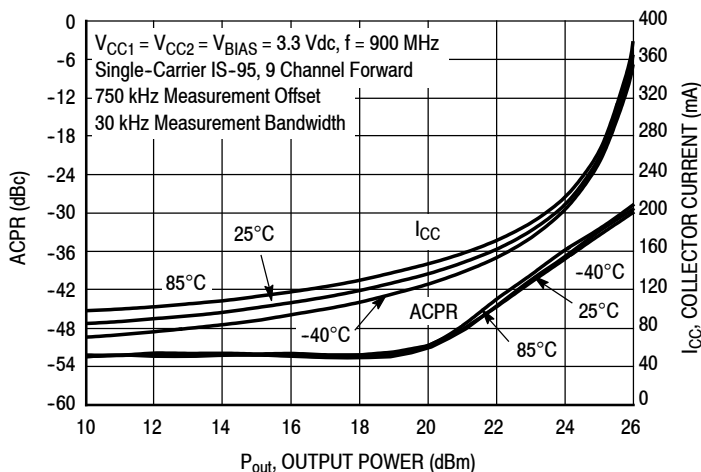

Figure 25. ACPR versus Collector Current versus Output Power versus Temperature

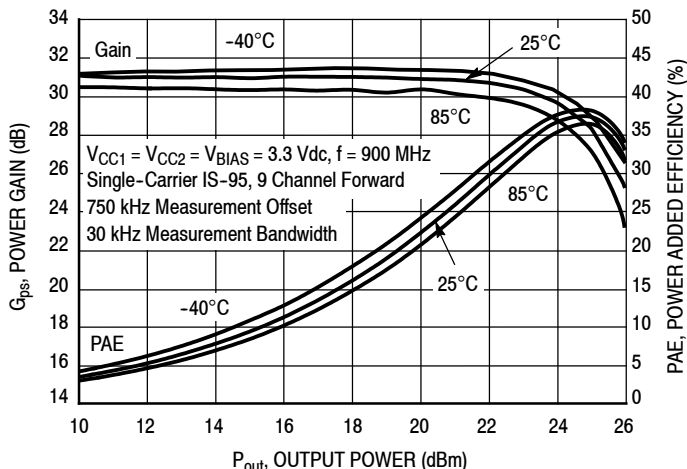

Figure 26. Power Gain versus Power Added Efficiency versus Output Power versus Temperature

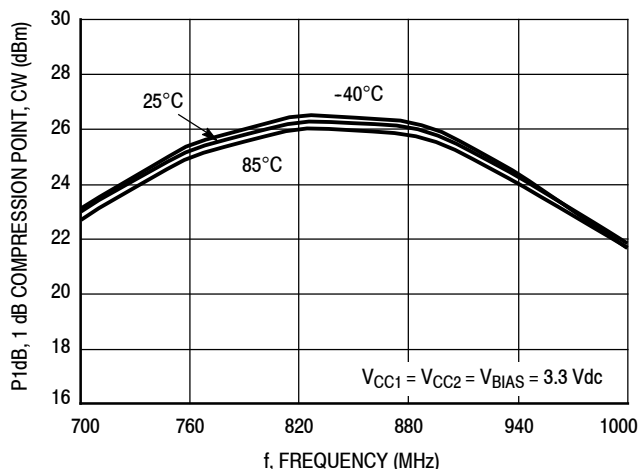

Figure 27. P1dB versus Frequency versus Temperature, CW

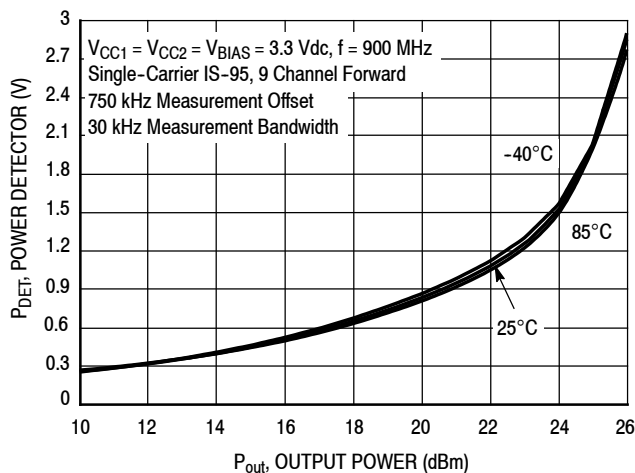

Figure 28. Power Detector versus Output Power versus Temperature

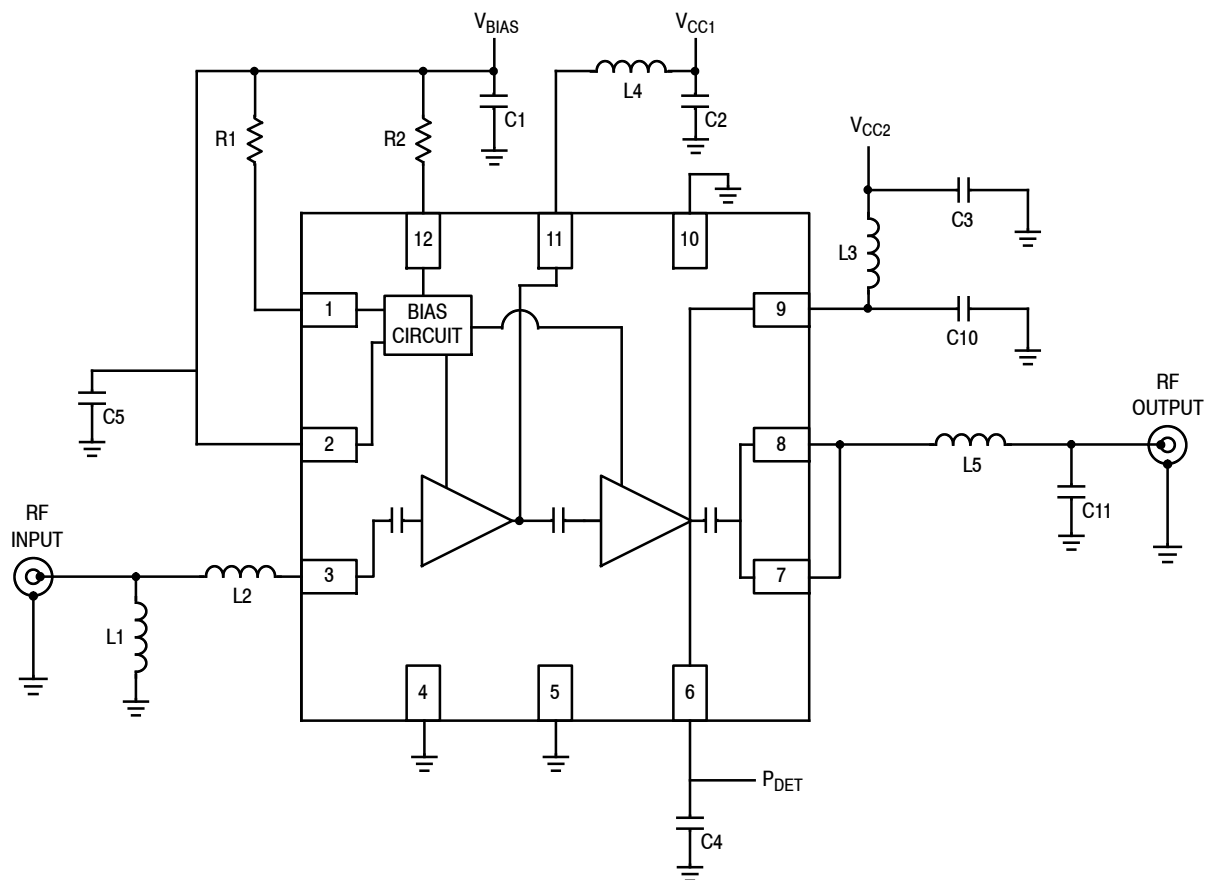
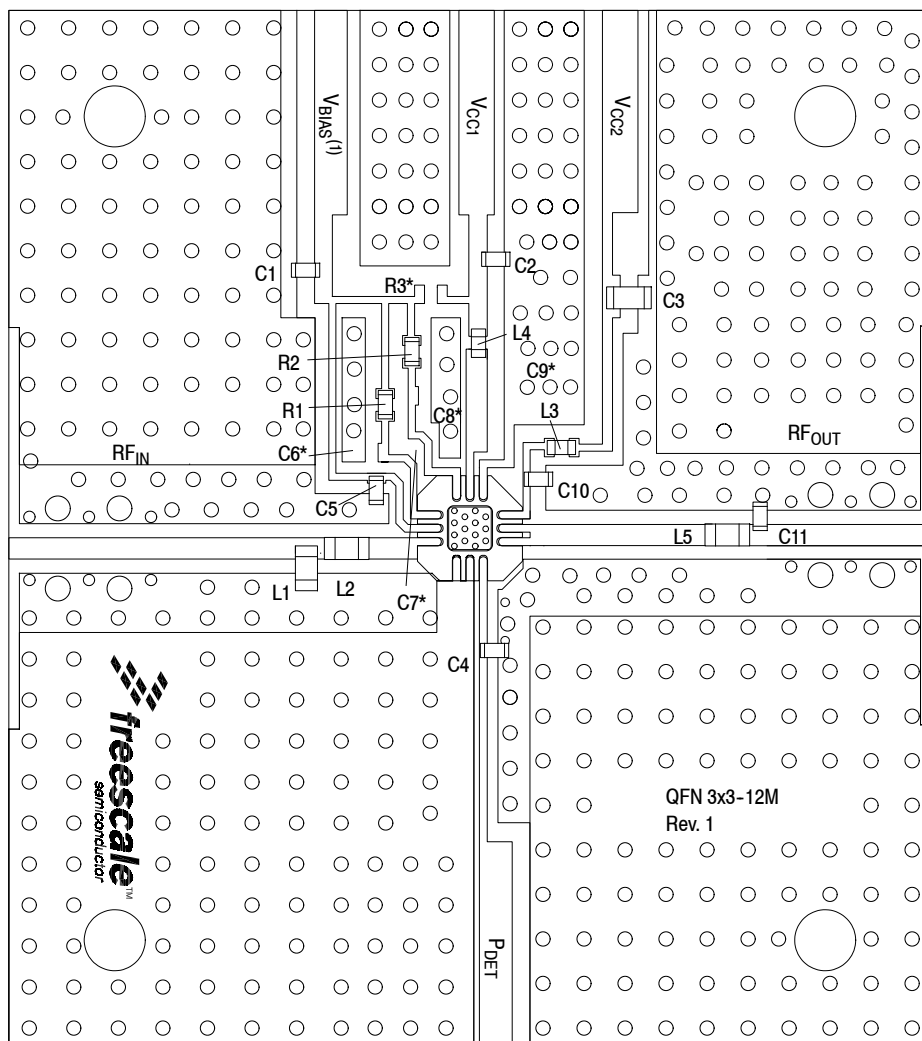

Figure 29. MMZ09312B Test Circuit Schematic — UMTS/LTE, 900 MHz, 3.3 V

Table 10. MMZ09312B Test Circuit Component Designations and Values — UMTS/LTE, 900 MHz, 3.3 V

Part	Description	Part Number	Manufacturer
C1, C2	1 μ F Chip Capacitors	GRM155R61A105KE15	Murata
C3	4.7 μ F Chip Capacitor	GRM188R60J475KE19	Murata
C4	470 pF Chip Capacitor	GRM1555C1H471JA01	Murata
C5	100 pF Chip Capacitor	GRM1555C1H101JA01	Murata
C6, C7, C8, C9	Components Not Placed		
C10	3.9 pF Chip Capacitor	04023J3R9BBSTR	AVX
C11	6.8 pF Chip Capacitor	04023J6R8BBSTR	AVX
L1	8.2 nH Chip Inductor	LL1608-FSL8N2JL	TOKO
L2	1.2 nH Chip Inductor	LL1608-FSL1N2S	TOKO
L3	33 nH Chip Inductor	0402CS-33NXGLW	Coilcraft
L4	22 nH Chip Inductor	0402CS-22NXGLW	Coilcraft
L5	3.3 nH Chip Inductor	0603CS-3N3XJLW	Coilcraft
R1	82 Ω , 1/16 W Chip Resistor	RC0402JR-07820RL	Yageo
R2	470 Ω , 1/16 W Chip Resistor	RC0402JR-07471RL	Yageo
R3	Component Not Placed		
PCB	0.014", $\epsilon_r = 3.7$	FR408	Isola

Note: Component numbers C6, C7, C8, C9 and R3 are labeled on board but not placed.



(1) V_{BIAS} [Board] supplies V_{BA1} , V_{BA2} and V_{BIAS} [Device].
 Note: Component numbers C6*, C7*, C8*, C9* and R3* are labeled on board but not placed.

Figure 30. MMZ09312B Test Circuit Component Layout — UMTS/LTE, 900 MHz, 3.3 V

Table 10. MMZ09312B Test Circuit Component Designations and Values — UMTS/LTE, 900 MHz, 3.3 V

Part	Description	Part Number	Manufacturer
C1, C2	1 μ F Chip Capacitors	GRM155R61A105KE15	Murata
C3	4.7 μ F Chip Capacitor	GRM188R60J475KE19	Murata
C4	470 pF Chip Capacitor	GRM1555C1H471JA01	Murata
C5	100 pF Chip Capacitor	GRM1555C1H101JA01	Murata
C6, C7, C8, C9	Components Not Placed		
C10	3.9 pF Chip Capacitor	04023J3R9BBSTR	AVX
C11	6.8 pF Chip Capacitor	04023J6R8BBSTR	AVX
L1	8.2 nH Chip Inductor	LL1608-FSL8N2JL	TOKO
L2	1.2 nH Chip Inductor	LL1608-FSL1N2S	TOKO
L3	33 nH Chip Inductor	0402CS-33NXGLW	Coilcraft
L4	22 nH Chip Inductor	0402CS-22NXGLW	Coilcraft
L5	3.3 nH Chip Inductor	0603CS-3N3XJLW	Coilcraft
R1	82 Ω , 1/16 W Chip Resistor	RC0402JR-07820RL	Yageo
R2	470 Ω , 1/16 W Chip Resistor	RC0402JR-07471RL	Yageo
R3	Component Not Placed		
PCB	0.014", $\epsilon_r = 3.7$	FR408	Isola

(Test Circuit Component Designations and Values table repeated for reference.)

MMZ09312BT1

TYPICAL CHARACTERISTICS — UMTS/LTE, 900 MHz, 3.3 V

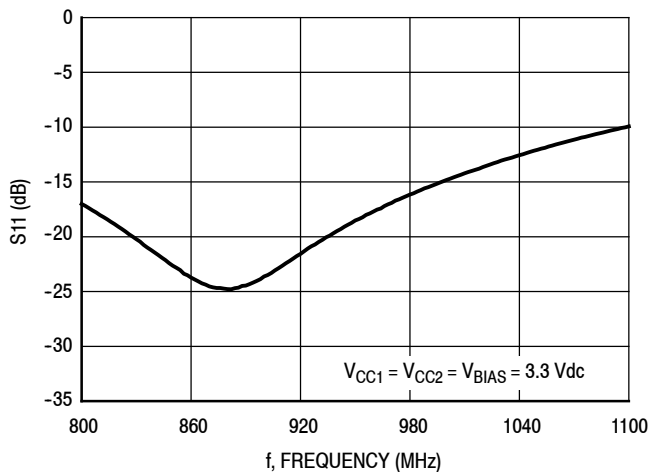

Figure 31. S11 versus Frequency

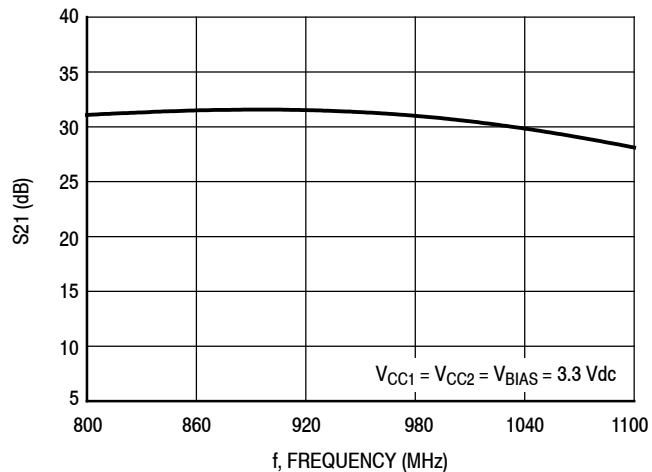

Figure 32. S21 versus Frequency

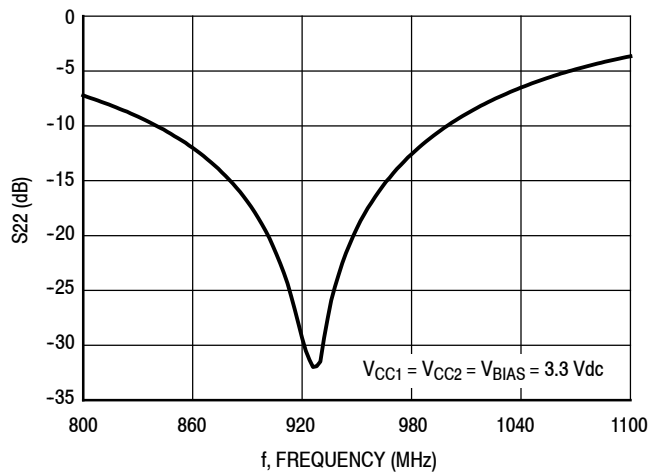

Figure 33. S22 versus Frequency

TYPICAL CHARACTERISTICS — UMTS/LTE, 900 MHz, 3.3 V

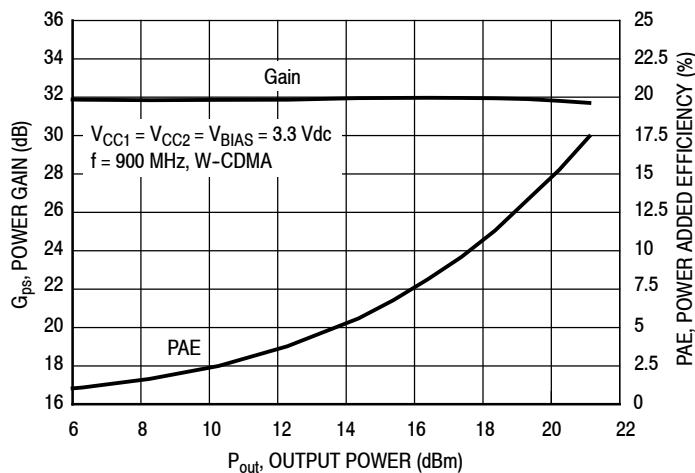

Figure 34. Power Gain and Power Added Efficiency versus Output Power

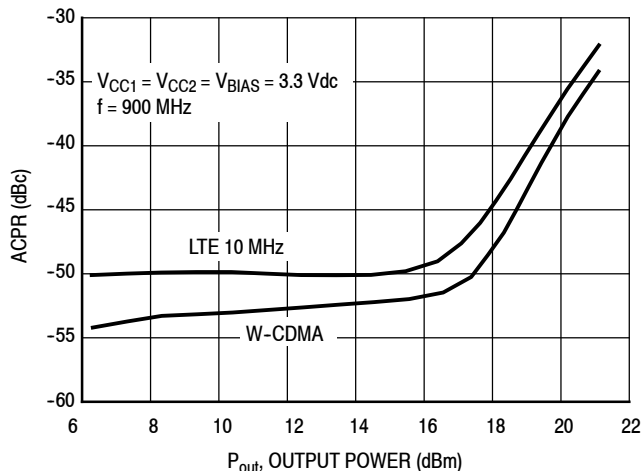

Figure 35. ACPR versus Output Power

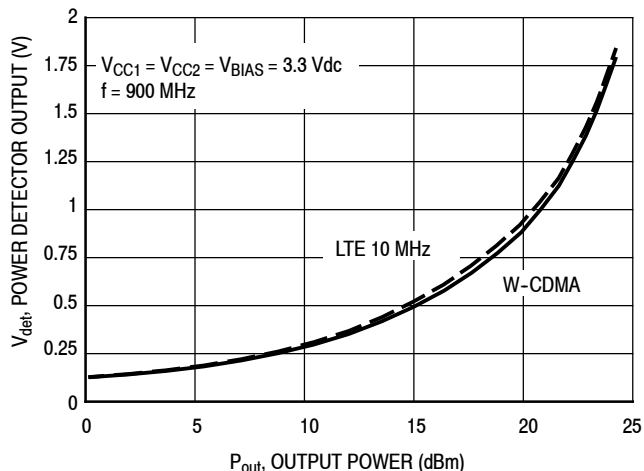

Figure 36. Power Detector Output versus Output Power

OPERATING CONDITIONS FOR FIGURES 34–36

W-CDMA
 Single-Carrier W-CDMA 3GPP TM1
 CF = 9.31 dB, Channel Bandwidth = 3.84 MHz
 Adjacent Channel Bandwidth = 3.84 MHz
 Channel Offset = ±5 MHz

LTE 10 MHz
 LTE 10 MHz 3GPP TM1.1
 CF = 11.70 dB, Channel Bandwidth = 9 MHz
 Adjacent Channel Bandwidth = 9 MHz
 Channel Offset = ±10 MHz

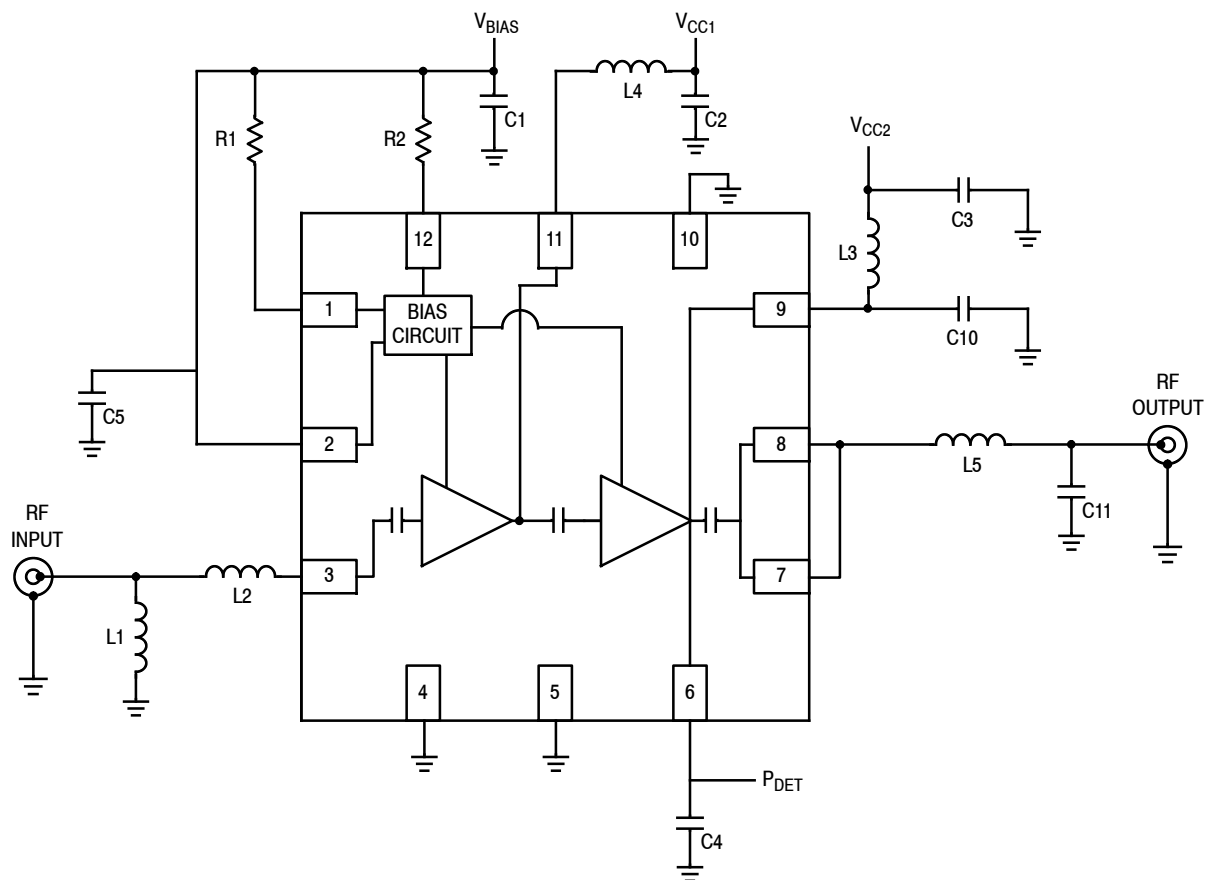
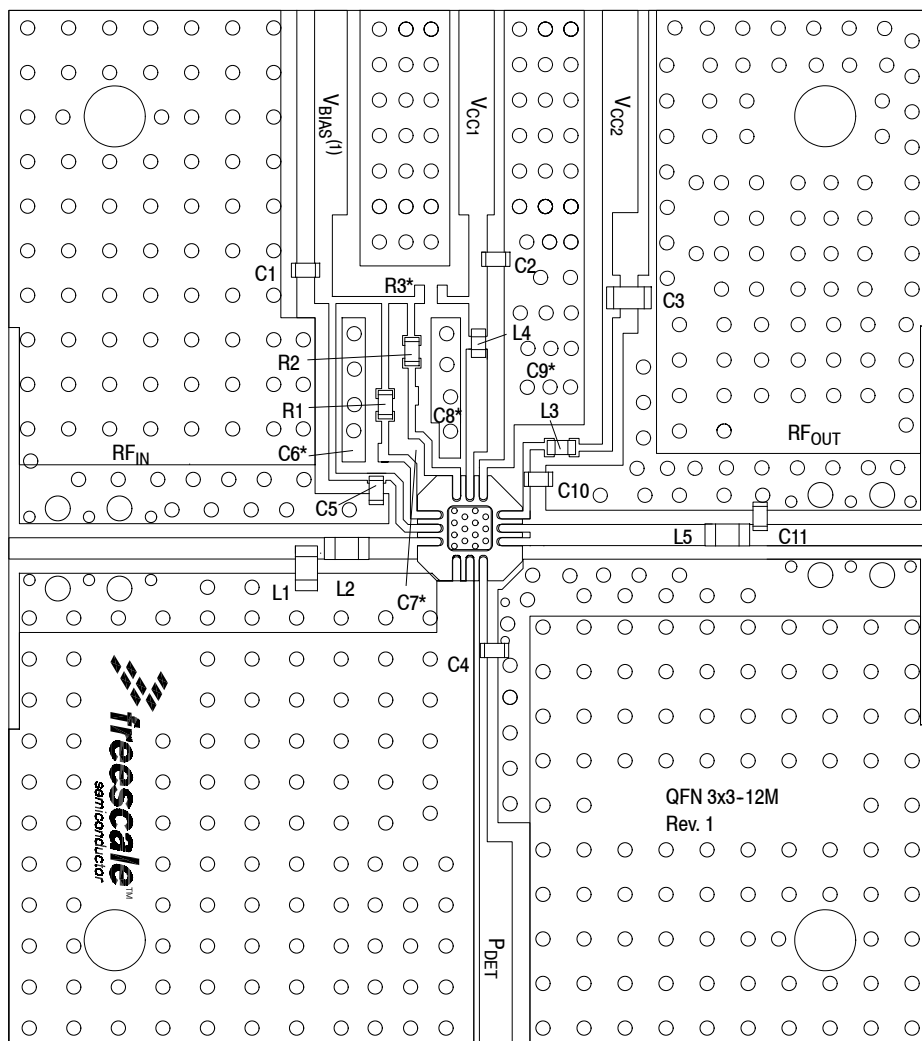

Figure 37. MMZ09312B Test Circuit Schematic — ZigBee, 450 MHz, 5.0 V

Table 11. MMZ09312B Test Circuit Component Designations and Values — ZigBee, 450 MHz, 5.0 V

Part	Description	Part Number	Manufacturer
C1, C2	1 μ F Chip Capacitors	GRM155R61A105KE15	Murata
C3	4.7 μ F Chip Capacitor	GRM188R60J475KE19	Murata
C4	470 pF Chip Capacitor	GRM1555C1H471JA01	Murata
C5	100 pF Chip Capacitor	GRM1555C1H101JA01	Murata
C6, C7, C8, C9	Components Not Placed		
C10	3.9 pF Chip Capacitor	04023J3R9BBSTR	AVX
C11	10 pF Chip Capacitor	04023J10R0BBSTR	AVX
L1	18 nH Chip Inductor	LL1608-FSL18N0S	TOKO
L2	1.2 nH Chip Inductor	LL1608-FSL1N2S	TOKO
L3	3.9 nH Chip Inductor	LL1608-FSL3N9S	TOKO
L4	12 nH Chip Inductor	LL1608-FSL12N0S	TOKO
L5	12 nH Chip Inductor	0603CS-12NXJL	Coilcraft
R1	330 Ω , 1/16 W Chip Resistor	RC0402JR-07331RL	Yageo
R2	1.5 k Ω , 1/16 W Chip Resistor	RC0402JR-07152RL	Yageo
R3	Component Not Placed		
PCB	0.014", $\epsilon_r = 3.7$	FR408	Isola

Note: Component numbers C6, C7, C8, C9 and R3 are labeled on board but not placed.



(1) V_{BIAS} [Board] supplies V_{BA1} , V_{BA2} and V_{BIAS} [Device].

Note: Component numbers C6*, C7*, C8*, C9* and R3* are labeled on board but not placed.

Figure 38. MMZ09312B Test Circuit Component Layout — ZigBee, 450 MHz, 5.0 V

Table 11. MMZ09312B Test Circuit Component Designations and Values — ZigBee, 450 MHz, 5.0 V

Part	Description	Part Number	Manufacturer
C1, C2	1 μ F Chip Capacitors	GRM155R61A105KE15	Murata
C3	4.7 μ F Chip Capacitor	GRM188R60J475KE19	Murata
C4	470 pF Chip Capacitor	GRM1555C1H471JA01	Murata
C5	100 pF Chip Capacitor	GRM1555C1H101JA01	Murata
C6, C7, C8, C9	Components Not Placed		
C10	3.9 pF Chip Capacitor	04023J3R9BBSTR	AVX
C11	10 pF Chip Capacitor	04023J10R0BBSTR	AVX
L1	18 nH Chip Inductor	LL1608-FSL18N0S	TOKO
L2	1.2 nH Chip Inductor	LL1608-FSL1N2S	TOKO
L3	3.9 nH Chip Inductor	LL1608-FSL3N9S	TOKO
L4	12 nH Chip Inductor	LL1608-FSL12N0S	TOKO
L5	12 nH Chip Inductor	0603CS-12NXJL	Coilcraft
R1	330 Ω , 1/16 W Chip Resistor	RC0402JR-07331RL	Yageo
R2	1.5 k Ω , 1/16 W Chip Resistor	RC0402JR-07152RL	Yageo
R3	Component Not Placed		
PCB	0.014", $\epsilon_r = 3.7$	FR408	Isola

(Test Circuit Component Designations and Values table repeated for reference.)

MMZ09312BT1

TYPICAL CHARACTERISTICS — ZIGBEE, 450 MHz, 5.0 V

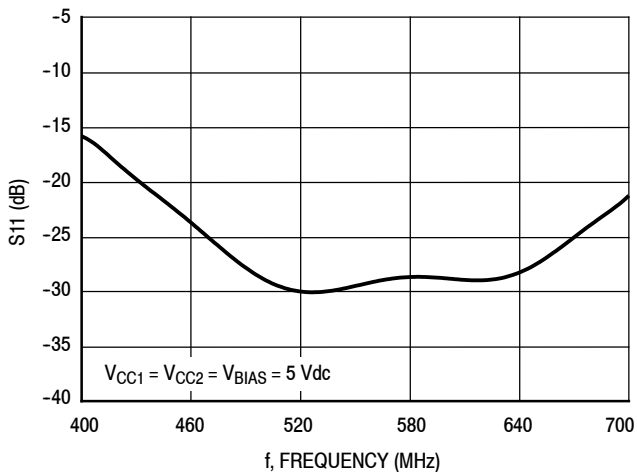

Figure 39. S11 versus Frequency

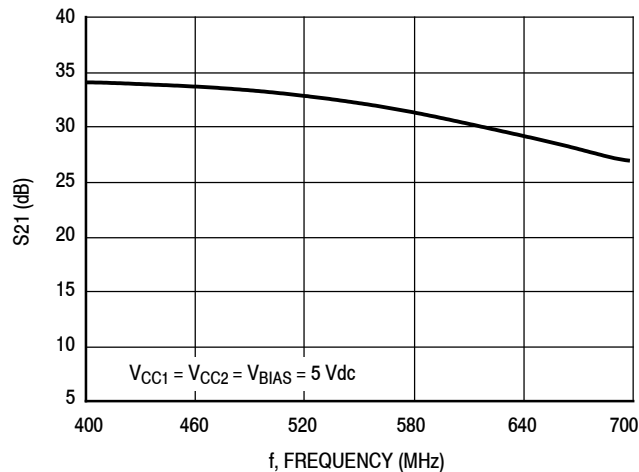

Figure 40. S21 versus Frequency

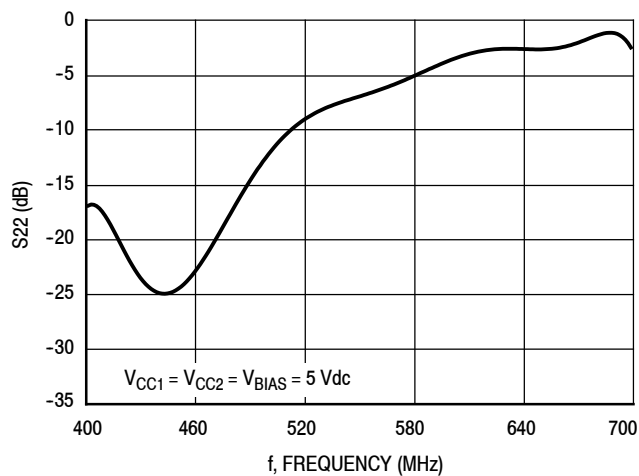

Figure 41. S22 versus Frequency

TYPICAL CHARACTERISTICS — ZIGBEE, 450 MHz, 5.0 V

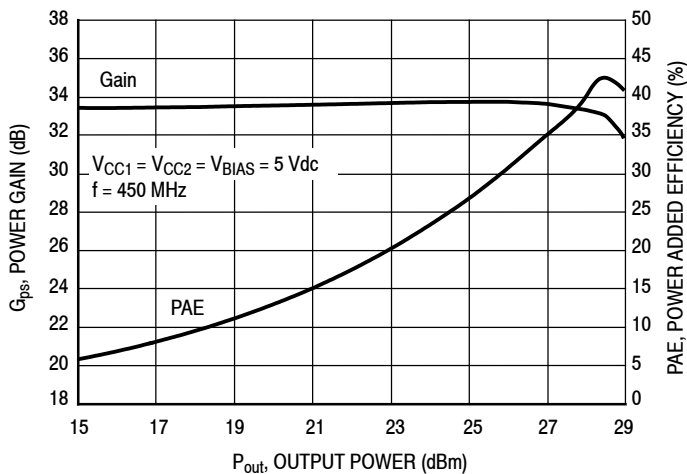

Figure 42. Power Gain versus Power Added Efficiency versus Output Power, CW

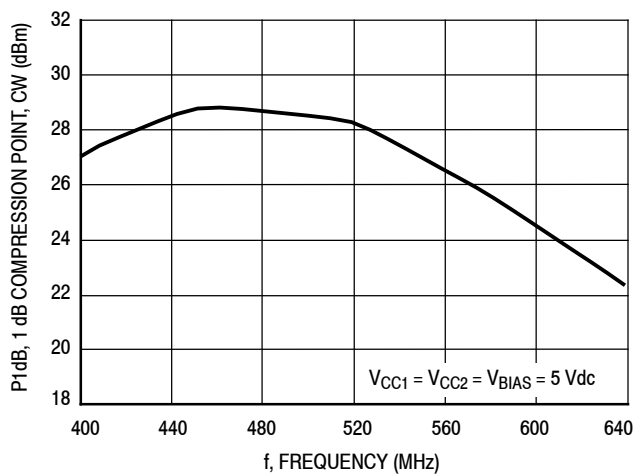

Figure 43. P1dB versus Frequency, CW

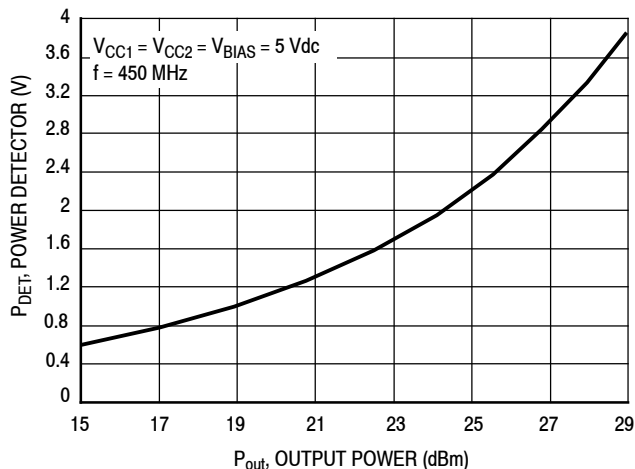

Figure 44. Power Detector versus Output Power, CW

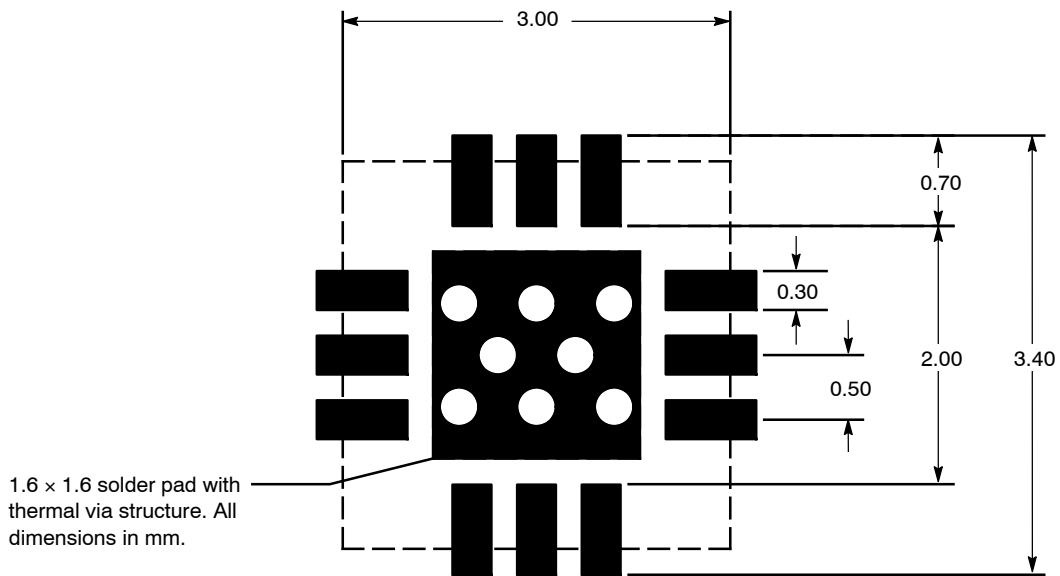
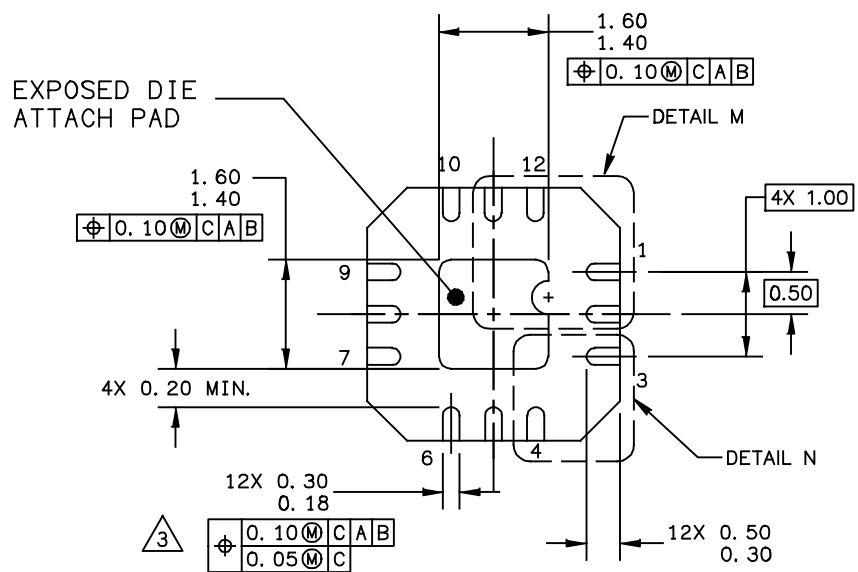
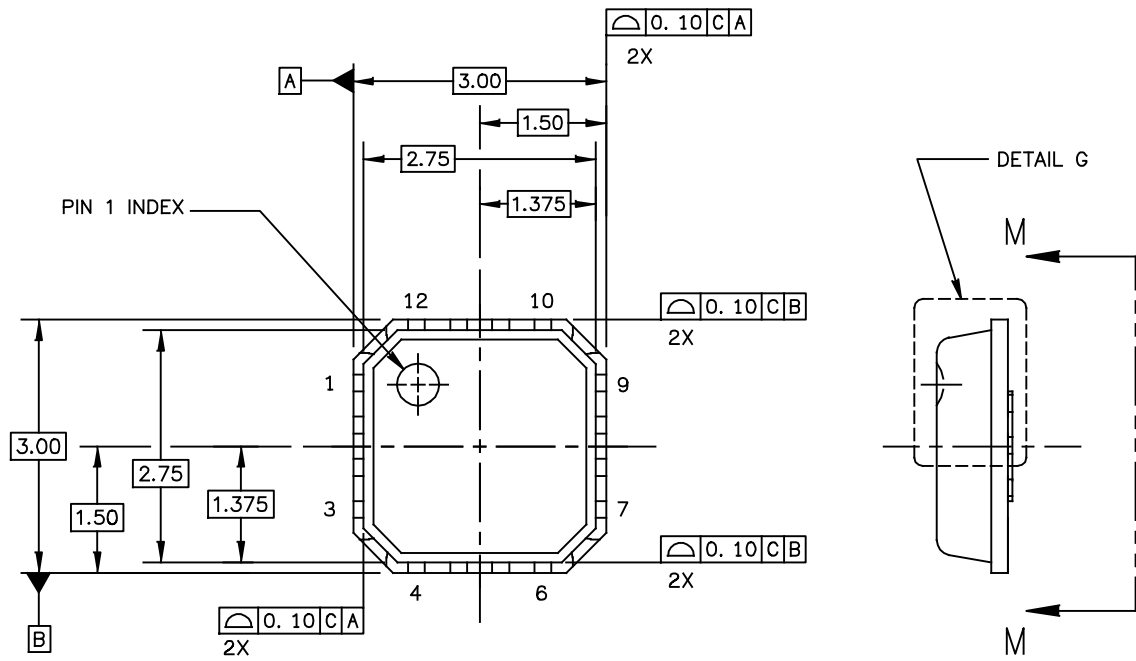

Figure 45. PCB Pad Layout for QFN 3 x 3



Figure 46. Product Marking

PACKAGE DIMENSIONS



VIEW M-M

© FREESCALE SEMICONDUCTOR, INC. ALL RIGHTS RESERVED.	MECHANICAL OUTLINE	PRINT VERSION NOT TO SCALE
TITLE: THERMALLY ENHANCED QUAD FLAT NON-LEADED PACKAGE (QFN) 12 TERMINAL, 0.5 PITCH (3X3X0.85)	DOCUMENT NO: 98ASA00227D	REV: 0
	CASE NUMBER: 2131-01	14 MAY 2010
	STANDARD: NON-JEDEC	

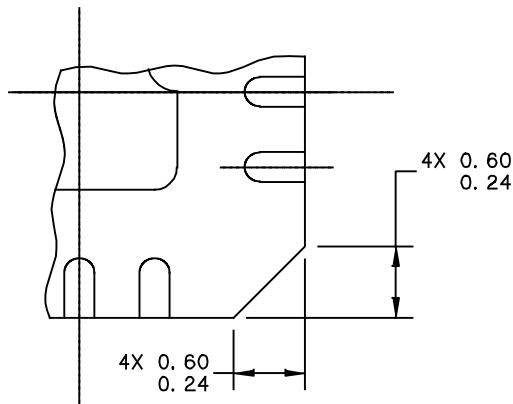

DETAIL N
CORNER CONFIGURATION

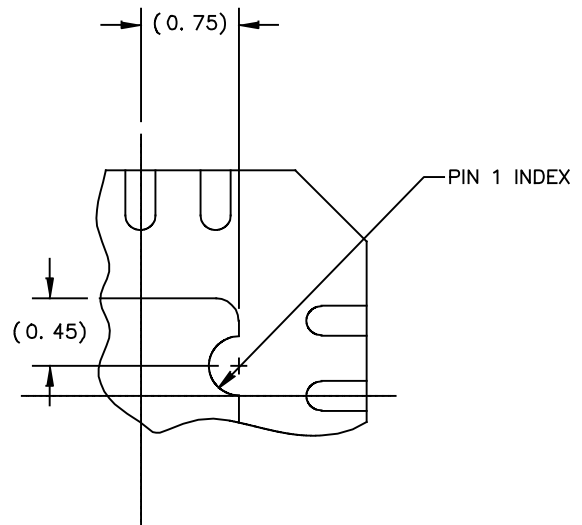

DETAIL M
PIN 1 BACKSIDE INDEX

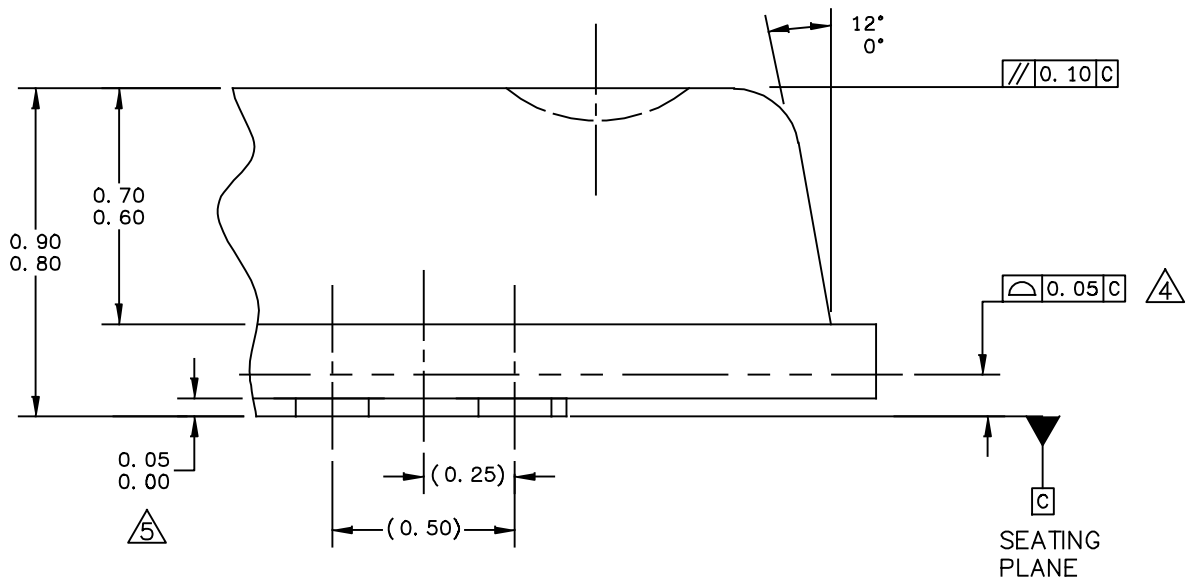

DETAIL G
VIEW ROTATED 90° CW

© FREESCALE SEMICONDUCTOR, INC. ALL RIGHTS RESERVED.	MECHANICAL OUTLINE	PRINT VERSION NOT TO SCALE	
TITLE: THERMALLY ENHANCED QUAD FLAT NON-LEADED PACKAGE (QFN) 12 TERMINAL, 0.5 PITCH (3X3X0.85)	DOCUMENT NO: 98ASA00227D	REV: 0	
	CASE NUMBER: 2131-01	14 MAY 2010	
	STANDARD: NON-JEDEC		

NOTE:

1. ALL DIMENSIONS ARE IN MILLIMETERS.
2. DIMENSIONING & TOLERANCING PER ASME Y14.5 – 2009.
3. THIS DIMENSION APPLIES TO PLATED TERMINAL AND IS MEASURED BETWEEN 0.15 AND 0.30 MM FROM TERMINAL TIP.
4. BILATERAL COPLANARITY ZONE APPLIES TO THE EXPOSED PAD AS WELL AS THE TERMINALS.
5. THIS DIMENSION APPLIED ONLY FOR TERMINALS.

© FREESCALE SEMICONDUCTOR, INC. ALL RIGHTS RESERVED.	MECHANICAL OUTLINE	PRINT VERSION NOT TO SCALE	
TITLE: THERMALLY ENHANCED QUAD FLAT NON-LEADED PACKAGE (QFN) 12 TERMINAL, 0.5 PITCH (3X3X0.85)		DOCUMENT NO: 98ASA00227D	REV: 0
		CASE NUMBER: 2131-01	14 MAY 2010
		STANDARD: NON-JEDEC	

PRODUCT DOCUMENTATION, SOFTWARE AND TOOLS

Refer to the following resources to aid your design process.

Application Notes

- AN1955: Thermal Measurement Methodology of RF Power Amplifiers

Software

- .s2p File

Development Tools

- Printed Circuit Boards

For Software and Tools, do a Part Number search at <http://www.freescale.com>, and select the “Part Number” link. Go to Software & Tools on the part’s Product Summary page to download the respective tool.

FAILURE ANALYSIS

At this time, because of the physical characteristics of the part, failure analysis is limited to electrical signature analysis. In cases where Freescale is contractually obligated to perform failure analysis (FA) services, full FA may be performed by third party vendors with moderate success. For updates contact your local Freescale Sales Office.

REVISION HISTORY

The following table summarizes revisions to this document.

Revision	Date	Description
0	Nov. 2011	<ul style="list-style-type: none">• Initial Release of Data Sheet
1	Feb. 2012	<ul style="list-style-type: none">• Typical Performance table: changed P_{out} at 750 MHz from 19.5 to 17.5 dBm to reflect recent performance measurements, p. 1• Figs. 3, 12 and 21, MMZ09312B Test Circuit Schematic: corrected L1 inductor label in test circuit schematics, pp. 3, 7 and 11
2	Dec. 2014	<ul style="list-style-type: none">• Typical Performance table: added 900 MHz, 1C W-CDMA TM1 and 900 MHz, 10 MHz LTE TM1.1, p. 1• Table 2, Maximum Ratings: updated Junction Temperature from 150°C to 175°C to reflect recent test results of the device, p. 1• Added application circuit for UMTS/LTE, 900 MHz, 5.0 V as follows: schematic, component designations and values, component layout, and typical characteristic performance graphs, pp. 7-10• Added application circuit for UMTS/LTE, 900 MHz, 3.3 V as follows: schematic, component designations and values, component layout, and typical characteristic performance graphs, pp. 15-18• Fig. 46, Product Marking: updated date code line to reflect improved traceability information, p. 23• Added Failure Analysis information, p. 27

How to Reach Us:

Home Page:
freescale.com

Web Support:
freescale.com/support

Information in this document is provided solely to enable system and software implementers to use Freescale products. There are no express or implied copyright licenses granted hereunder to design or fabricate any integrated circuits based on the information in this document.

Freescale reserves the right to make changes without further notice to any products herein. Freescale makes no warranty, representation, or guarantee regarding the suitability of its products for any particular purpose, nor does Freescale assume any liability arising out of the application or use of any product or circuit, and specifically disclaims any and all liability, including without limitation consequential or incidental damages. "Typical" parameters that may be provided in Freescale data sheets and/or specifications can and do vary in different applications, and actual performance may vary over time. All operating parameters, including "typicals," must be validated for each customer application by customer's technical experts. Freescale does not convey any license under its patent rights nor the rights of others. Freescale sells products pursuant to standard terms and conditions of sale, which can be found at the following address: freescale.com/SalesTermsandConditions.

Freescale and the Freescale logo are trademarks of Freescale Semiconductor, Inc., Reg. U.S. Pat. & Tm. Off. All other product or service names are the property of their respective owners.

© 2011–2012, 2014 Freescale Semiconductor, Inc.

