

## 4-CHANNEL ESD SOLUTION FOR USB-HS/USB OTG/USB CHARGER INTERFACE

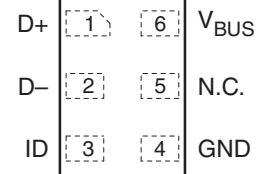
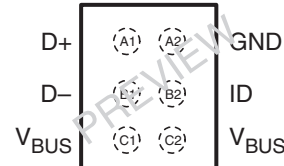
Check for Samples: [TPD4S012](#)

### FEATURES

- Integrated ESD Clamps for D+, D–, V<sub>BUS</sub>, and ID Pins to Provide Single-Chip ESD Protection for USB High Speed, USB-OTG, and USB Charger Interface
- Special Snap Back Technology Allows High-voltage Tolerance During Normal Operation while Reducing the Clamp Voltage during System Level ESD Stress
- USB Signal Pins (D+, D–, ID)
  - 0.8-pF Line Capacitance
  - Tolerates 6 V Signal
- V<sub>BUS</sub> Line (V<sub>BUS</sub>)
  - 11-pF Line Capacitance
  - Tolerates 20 V Signal
- Flow-Through Pin Mapping for the High-Speed Lines Ensures Zero Additional Skew Due to Board Layout While Placing the ESD Protection Chip Near the Connector
- Supports Data Rates in Excess of 480 Mbps
- IEC 61000-4-2 (Level 4) System Level ESD Compliance Measured at the D+, D–, and ID Pins
  - $\hat{A}\pm 10$ -kV IEC 61000-4-2 Contact Discharge
  - $\hat{A}\pm 10$ -kV IEC 61000-4-2 Air-Gap Discharge
- 3 Amps Peak Pulse Current (8/20  $\mu$ s Pulse) for V<sub>BUS</sub> and D+, D–, and ID Lines
- Industrial Temperature Range: –40°C to 85°C

### APPLICATIONS

- Cellular Phones
- Digital Cameras
- Global Positioning Systems (GPS)
- Portable Digital Assistants (PDA)
- Portable Computers

**DRY PACKAGE  
(TOP VIEW)**

**YFP PACKAGE  
(TOP VIEW)**


N.C. – Not internally connected

D+, D–, and ID pins are exact equivalent ESD clamp circuits. Any of these pins can be connected to any other D+, D–, or ID pin if it becomes easier to route the traces from the USB connector.

### DESCRIPTION

The TPD4S012 is a four-channel electrostatic discharge (ESD) solution for USB charger or USB on-the-go (OTG) interface. In many cell phone applications, the USB connector is the de facto communication port for external communications like high-speed data transfer, audio signal, charging, car-kit, etc. In order to support different interfaces, the USB port needs to handle different voltage levels. For example, some chargers require the V<sub>BUS</sub> port of the USB connector to handle in excess of the normal V<sub>BUS</sub> voltage per USB specifications. The TPD4S012 offers combinations of two different clamp voltages to match the voltage tolerances of the different signal interfaces using the common USB connector. Refer to Figure 5-6 & Figure 9-12, special snap back technology allows high-voltage tolerance during normal operation while reducing the clamp voltage during system level ESD stress.

The TPD4S012 conforms to IEC61000-4-2 (Level 4) ESD. The device is offered in space-saving packages with flow-through pin mapping.

The TPD4S012 is characterized for operation over ambient air temperature of –40°C to 85°C.



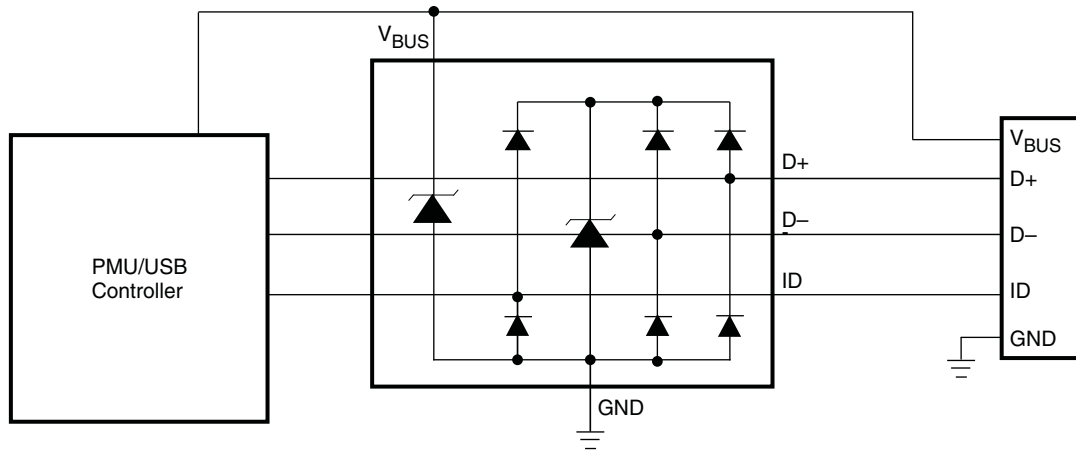
Please be aware that an important notice concerning availability, standard warranty, and use in critical applications of Texas Instruments semiconductor products and disclaimers thereto appears at the end of this data sheet.

**ORDERING INFORMATION**

T <sub>A</sub>	PACKAGE (1) (2)		NOMINAL DIMENSIONS (mm)	ORDERABLE PART NUMBER	TOP-SIDE MARKING
	SON – DRY	Reel of 3000			
–40°C to 85°C	SON – DRY	Reel of 3000	W = 1.0, L = 1.45, H = 0.55, Pitch = 0.5	TPD4S012DRYR	3B
	WCSP – XXX	Reel of 3000	W = 0.8, L = 1.2, H = 0.5, Pitch = 0.4	TPD4S012XXXR	TBD

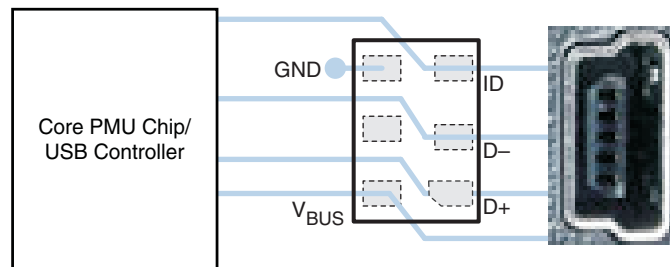
- (1) Package drawings, thermal data, and symbolization are available at [www.ti.com/packaging](http://www.ti.com/packaging).
- (2) For the most current package and ordering information, see the Package Option Addendum at the end of this document, or see the TI website at [www.ti.com](http://www.ti.com).

**APPLICATION SCHEMATIC**

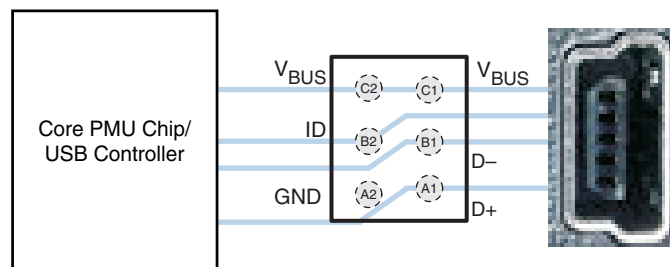


If the ID pin is not used, it can be left floating.

**Board Layout Recommendations**

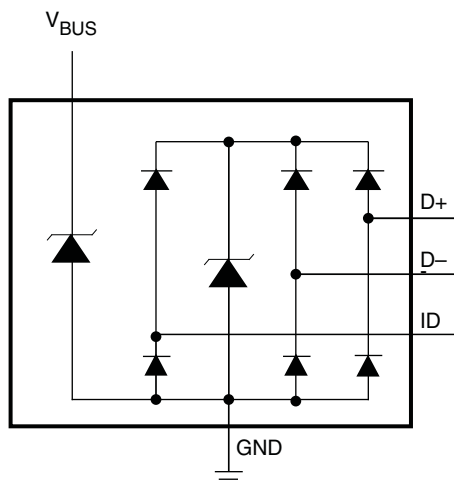


**Figure 1. Using DRY Package**



**Figure 2. Using YFP Package**

The TPD4S012 can provide system-level ESD protection to the high-speed differential ports. The flow-through package offers flexibility for board routing. Figure 1 and Figure 2 show the board layout scheme for the D+ and D– lines of a single differential pair. It allows the differential signal pairs couple together right after they touch the ESD ports of the TPD4S012.

**CIRCUIT DIAGRAM**

**TERMINAL FUNCTIONS**

TERMINAL			TYPE	DESCRIPTION
DRY PIN NO.	XXX BALL NO.	NAME		
1	A1	D+	ESD clamp	Provides ESD protection to the high-speed differential data lines
2	B1	D-	ESD clamp	Provides ESD protection to the high-speed differential data lines
3	B2	ID	ESD clamp	Provides ESD protection to the high-speed differential data lines
4	A2	GND	Pwr	Ground
5	–	N.C.	–	Not internally connected
6	C1, C2	V <sub>BUS</sub>	ESD clamp	ESD clamp for high-voltage tolerant V <sub>BUS</sub> line(s)

**ABSOLUTE MAXIMUM RATINGS**

over operating free-air temperature range (unless otherwise noted)

		MIN	MAX	UNIT
V <sub>BUS</sub> voltage tolerance	V <sub>BUS</sub> pin	–0.3	20	V
IO voltage tolerance	D+, D–, ID pins	–0.3	6	V
T <sub>stg</sub>	Storage temperature range	–65	125	°C
T <sub>A</sub>	Operating free-air temperature range	–40	85	°C
	IEC 61000-4-2 Contact Discharge		±10	kV
	IEC 61000-4-2 Air-Gap Discharge		±10	kV
	IEC 61000-4-2 Contact Discharge		±10	kV
	IEC 61000-4-2 Air-Gap Discharge		±9	kV
	Peak pulse power (t <sub>p</sub> = 8/20 μs)		60	W
	Peak pulse current (t <sub>p</sub> = 8/20 μs)		3	A

### ELECTRICAL CHARACTERISTICS

over operating free-air temperature range (unless otherwise noted)

PARAMETER		TEST CONDITIONS		MIN	TYP	MAX	UNIT
$I_{V_{BUS}}$	$V_{BUS}$ operating current	$V_{BUS} = 5\text{ V}$	D+, D-, ID pins open		0.1	0.5	$\mu\text{A}$
		$V_{BUS} = 19\text{ V}$					
$I_{IO}$	IO port current	$V_{IO} = 2.5\text{ V}, V_{BUS} = 5\text{ V}$	D+, D-, ID pins		0.1	0.5	$\mu\text{A}$
$V_D$	Diode forward voltage	$I_{IO} = 8\text{ mA}$	D+, D-, ID pins (lower clamp diode)	0.6	0.8	0.95	V
$C_{V_{BUS}}$	$V_{BUS}$ pin capacitance	$V_{BUS} = 5\text{ V}$			11	15	pF
$C_{IO}$	IO capacitance	$V_{IO} = 2.5\text{ V}$	D+, D-, ID pins (DRY package)		0.8	1	pF
$R_{DYN}$	Dynamic resistance	$I_{IO} = 1.5\text{ A}$	D+, D-, ID, and $V_{BUS}$ pins, including central clamp diode during positive ESD pulse		1.2		$\Omega$
		$I_{IO} = 1\text{ A}$	D+, D-, ID, and $V_{BUS}$ pins, including central clamp diode during negative ESD pulse		1		
$V_{BR}$	Breakdown voltage	$I_{IO} = 1\text{ mA}$	D+, D-, ID pins	6	9		V
			$V_{BUS}$ pin(s)	20	24		

### TYPICAL CHARACTERISTICS

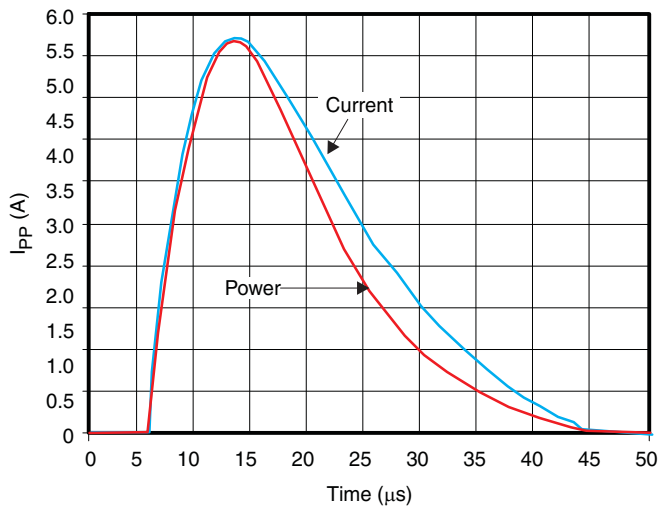


Figure 3. Peak Pulse Power Waveform at the D+, D-, or ID Pin

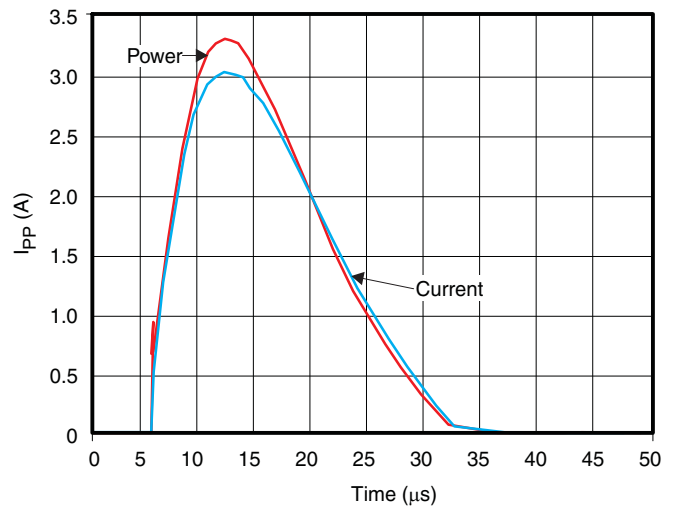


Figure 4. Peak Pulse Power Waveform at the  $V_{BUS}$  Pin

TYPICAL CHARACTERISTICS (continued)

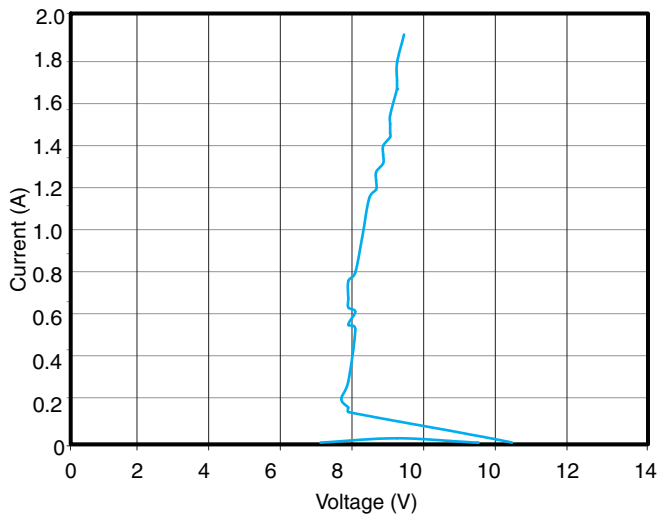


Figure 5. D+, D-, or ID Clamp Voltage Under ESD Event

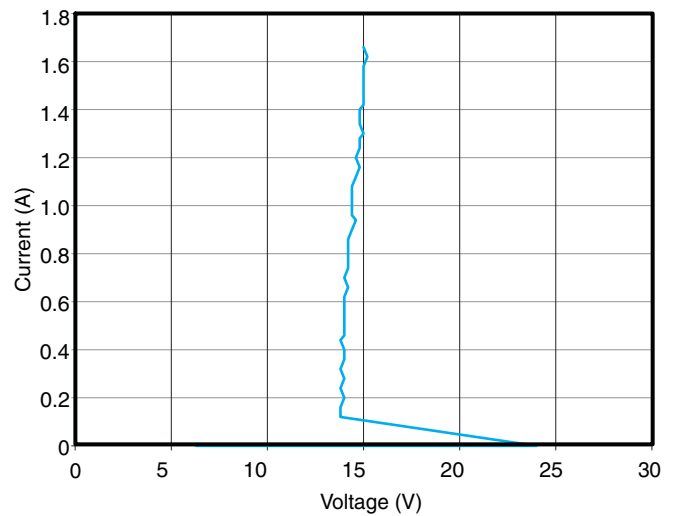


Figure 6. V<sub>BUS</sub> Clamp Voltage Under ESD Event

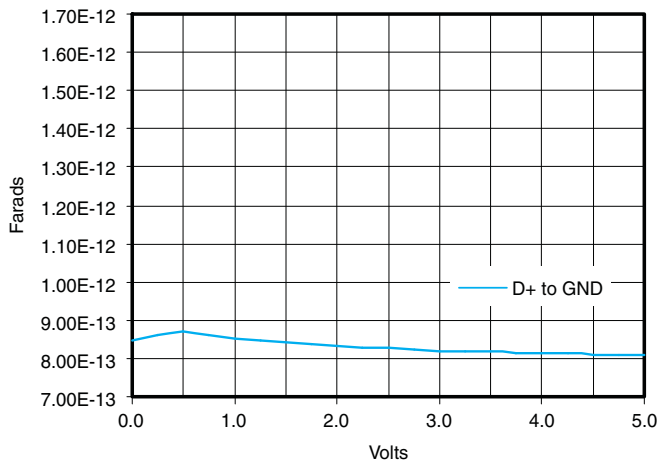


Figure 7. D+, D-, or ID Capacitance, T<sub>A</sub> = 27°C

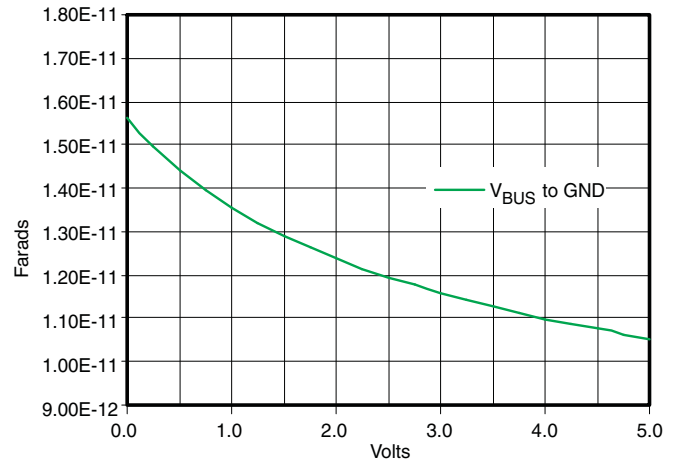


Figure 8. V<sub>BUS</sub> Capacitance, T<sub>A</sub> = 27°C

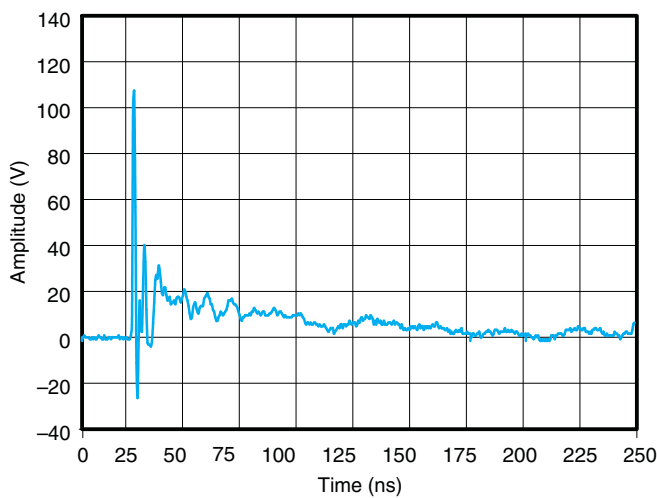


Figure 9. IEC Clamping Waveform, 8 kV Contact, D+, 25 ns/div

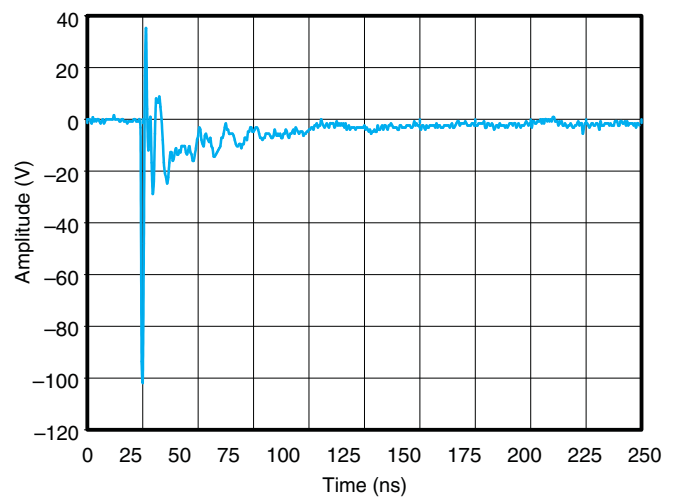


Figure 10. IEC Clamping Waveform, -8 kV Contact, D+, 25 ns/div

TYPICAL CHARACTERISTICS (continued)

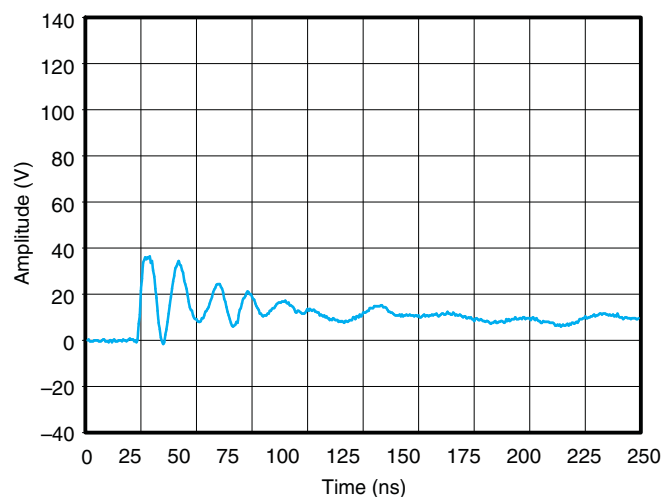


Figure 11.  $V_{BUS}$  IEC Clamping Waveform, 8 kV Contact, D+, 25 ns/div

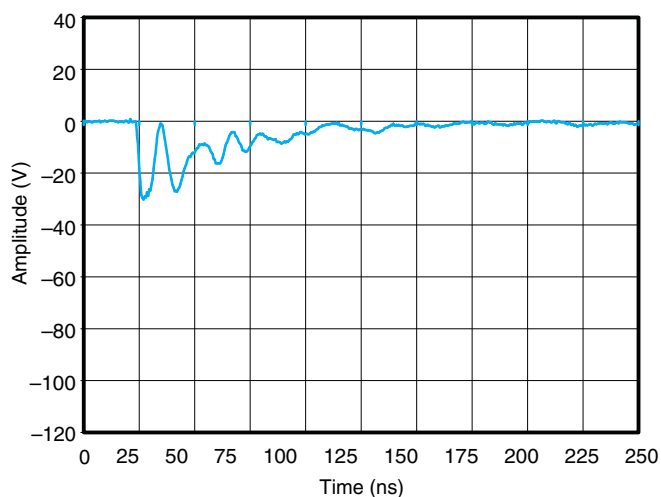



Figure 12.  $V_{BUS}$  IEC Clamping Waveform, -8 kV Contact, D+, 25 ns/div

**PACKAGING INFORMATION**

Orderable Device	Status (1)	Package Type	Package Drawing	Pins	Package Qty	Eco Plan (2)	Lead/Ball Finish	MSL Peak Temp (3)	Op Temp (°C)	Top-Side Markings (4)	Samples
TPD4S012DRYR	ACTIVE	SON	DRY	6	5000	Green (RoHS & no Sb/Br)	CU NIPDAU	Level-1-260C-UNLIM	-40 to 85	3B	

(1) The marketing status values are defined as follows:

**ACTIVE:** Product device recommended for new designs.

**LIFEBUY:** TI has announced that the device will be discontinued, and a lifetime-buy period is in effect.

**NRND:** Not recommended for new designs. Device is in production to support existing customers, but TI does not recommend using this part in a new design.

**PREVIEW:** Device has been announced but is not in production. Samples may or may not be available.

**OBSOLETE:** TI has discontinued the production of the device.

(2) Eco Plan - The planned eco-friendly classification: Pb-Free (RoHS), Pb-Free (RoHS Exempt), or Green (RoHS & no Sb/Br) - please check <http://www.ti.com/productcontent> for the latest availability information and additional product content details.

**TBD:** The Pb-Free/Green conversion plan has not been defined.

**Pb-Free (RoHS):** TI's terms "Lead-Free" or "Pb-Free" mean semiconductor products that are compatible with the current RoHS requirements for all 6 substances, including the requirement that lead not exceed 0.1% by weight in homogeneous materials. Where designed to be soldered at high temperatures, TI Pb-Free products are suitable for use in specified lead-free processes.

**Pb-Free (RoHS Exempt):** This component has a RoHS exemption for either 1) lead-based flip-chip solder bumps used between the die and package, or 2) lead-based die adhesive used between the die and leadframe. The component is otherwise considered Pb-Free (RoHS compatible) as defined above.

**Green (RoHS & no Sb/Br):** TI defines "Green" to mean Pb-Free (RoHS compatible), and free of Bromine (Br) and Antimony (Sb) based flame retardants (Br or Sb do not exceed 0.1% by weight in homogeneous material)

(3) MSL, Peak Temp. -- The Moisture Sensitivity Level rating according to the JEDEC industry standard classifications, and peak solder temperature.

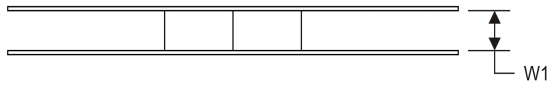
(4) Only one of markings shown within the brackets will appear on the physical device.

**Important Information and Disclaimer:** The information provided on this page represents TI's knowledge and belief as of the date that it is provided. TI bases its knowledge and belief on information provided by third parties, and makes no representation or warranty as to the accuracy of such information. Efforts are underway to better integrate information from third parties. TI has taken and continues to take reasonable steps to provide representative and accurate information but may not have conducted destructive testing or chemical analysis on incoming materials and chemicals. TI and TI suppliers consider certain information to be proprietary, and thus CAS numbers and other limited information may not be available for release.

In no event shall TI's liability arising out of such information exceed the total purchase price of the TI part(s) at issue in this document sold by TI to Customer on an annual basis.

**TAPE AND REEL INFORMATION**

**REEL DIMENSIONS**



**TAPE DIMENSIONS**



A0	Dimension designed to accommodate the component width
B0	Dimension designed to accommodate the component length
K0	Dimension designed to accommodate the component thickness
W	Overall width of the carrier tape
P1	Pitch between successive cavity centers

**TAPE AND REEL INFORMATION**

\*All dimensions are nominal

Device	Package Type	Package Drawing	Pins	SPQ	Reel Diameter (mm)	Reel Width W1 (mm)	A0 (mm)	B0 (mm)	K0 (mm)	P1 (mm)	W (mm)	Pin1 Quadrant
TPD4S012DRYR	SON	DRY	6	5000	179.0	8.4	1.2	1.65	0.7	4.0	8.0	Q1



TAPE AND REEL BOX DIMENSIONS

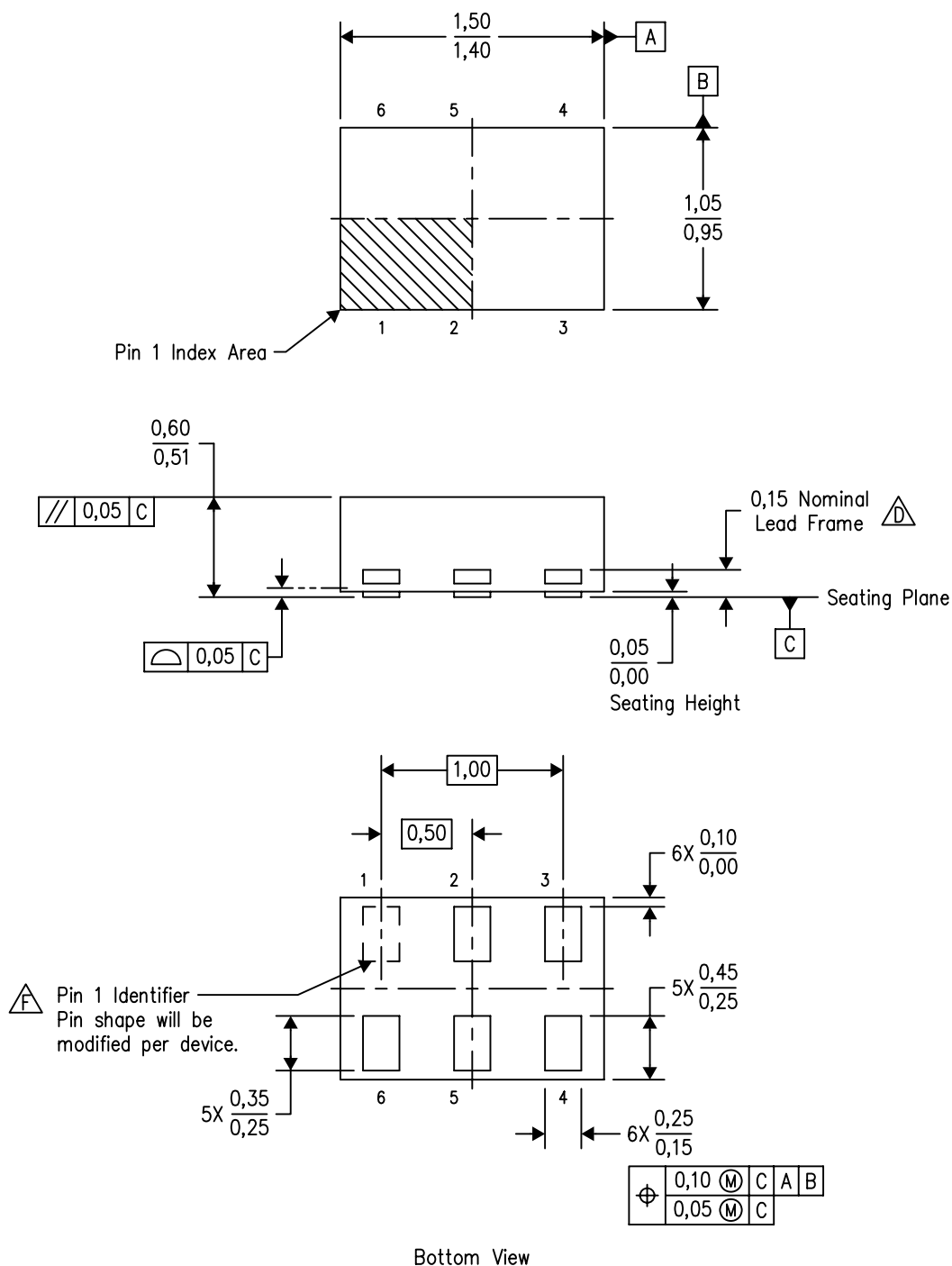


\*All dimensions are nominal

Device	Package Type	Package Drawing	Pins	SPQ	Length (mm)	Width (mm)	Height (mm)
TPD4S012DRYR	SON	DRY	6	5000	203.0	203.0	35.0

DRY (R-PUSON-N6)

PLASTIC SMALL OUTLINE NO-LEAD

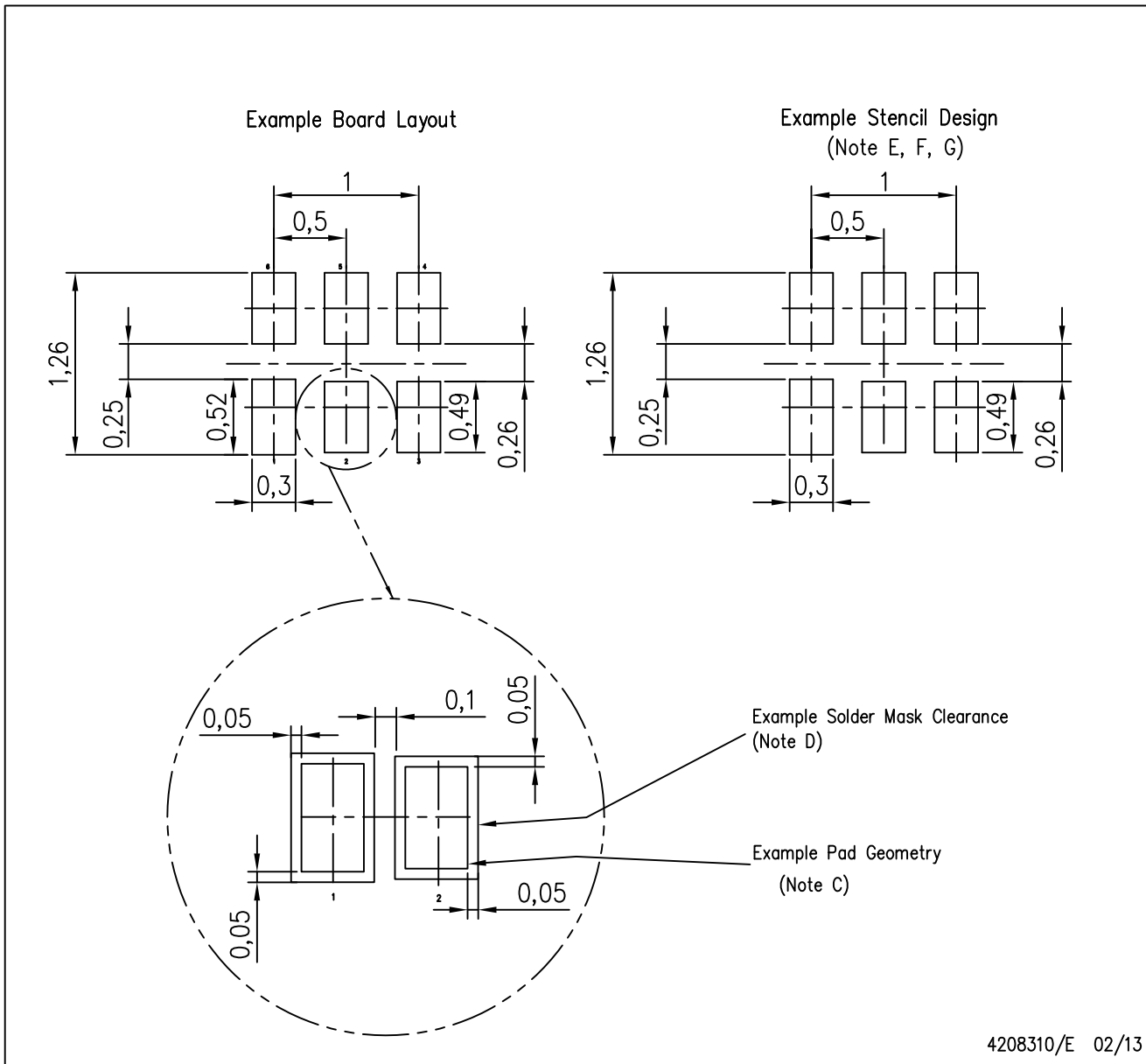


4207181/F 12/11

- NOTES:
- A. All linear dimensions are in millimeters. Dimensioning and tolerancing per ASME Y14.5M-1994.
  - B. This drawing is subject to change without notice.
  - C. SON (Small Outline No-Lead) package configuration.
  - $\triangle D$  The exposed lead frame feature on side of package may or may not be present due to alternative lead frame designs.
  - E. This package complies to JEDEC MO-287 variation UFAD.
  - $\triangle F$  See the additional figure in the Product Data Sheet for details regarding the pin 1 identifier shape.

DRY (R-PUSON-N6)

PLASTIC SMALL OUTLINE NO-LEAD



- NOTES:
- All linear dimensions are in millimeters.
  - This drawing is subject to change without notice.
  - Publication IPC-7351 is recommended for alternate designs.
  - Customers should contact their board fabrication site for minimum solder mask web tolerances between signal pads.
  - Maximum stencil thickness 0,127 mm (5 mils). All linear dimensions are in millimeters.
  - Laser cutting apertures with trapezoidal walls and also rounding corners will offer better paste release. Customers should contact their board assembly site for stencil design recommendations. Refer to IPC 7525 for stencil design considerations.
  - Side aperture dimensions over-print land for acceptable area ratio > 0.66. Customer may reduce side aperture dimensions if stencil manufacturing process allows for sufficient release at smaller opening.

## IMPORTANT NOTICE

Texas Instruments Incorporated and its subsidiaries (TI) reserve the right to make corrections, enhancements, improvements and other changes to its semiconductor products and services per JESD46, latest issue, and to discontinue any product or service per JESD48, latest issue. Buyers should obtain the latest relevant information before placing orders and should verify that such information is current and complete. All semiconductor products (also referred to herein as "components") are sold subject to TI's terms and conditions of sale supplied at the time of order acknowledgment.

TI warrants performance of its components to the specifications applicable at the time of sale, in accordance with the warranty in TI's terms and conditions of sale of semiconductor products. Testing and other quality control techniques are used to the extent TI deems necessary to support this warranty. Except where mandated by applicable law, testing of all parameters of each component is not necessarily performed.

TI assumes no liability for applications assistance or the design of Buyers' products. Buyers are responsible for their products and applications using TI components. To minimize the risks associated with Buyers' products and applications, Buyers should provide adequate design and operating safeguards.

TI does not warrant or represent that any license, either express or implied, is granted under any patent right, copyright, mask work right, or other intellectual property right relating to any combination, machine, or process in which TI components or services are used. Information published by TI regarding third-party products or services does not constitute a license to use such products or services or a warranty or endorsement thereof. Use of such information may require a license from a third party under the patents or other intellectual property of the third party, or a license from TI under the patents or other intellectual property of TI.

Reproduction of significant portions of TI information in TI data books or data sheets is permissible only if reproduction is without alteration and is accompanied by all associated warranties, conditions, limitations, and notices. TI is not responsible or liable for such altered documentation. Information of third parties may be subject to additional restrictions.

Resale of TI components or services with statements different from or beyond the parameters stated by TI for that component or service voids all express and any implied warranties for the associated TI component or service and is an unfair and deceptive business practice. TI is not responsible or liable for any such statements.

Buyer acknowledges and agrees that it is solely responsible for compliance with all legal, regulatory and safety-related requirements concerning its products, and any use of TI components in its applications, notwithstanding any applications-related information or support that may be provided by TI. Buyer represents and agrees that it has all the necessary expertise to create and implement safeguards which anticipate dangerous consequences of failures, monitor failures and their consequences, lessen the likelihood of failures that might cause harm and take appropriate remedial actions. Buyer will fully indemnify TI and its representatives against any damages arising out of the use of any TI components in safety-critical applications.

In some cases, TI components may be promoted specifically to facilitate safety-related applications. With such components, TI's goal is to help enable customers to design and create their own end-product solutions that meet applicable functional safety standards and requirements. Nonetheless, such components are subject to these terms.

No TI components are authorized for use in FDA Class III (or similar life-critical medical equipment) unless authorized officers of the parties have executed a special agreement specifically governing such use.

Only those TI components which TI has specifically designated as military grade or "enhanced plastic" are designed and intended for use in military/aerospace applications or environments. Buyer acknowledges and agrees that any military or aerospace use of TI components which have **not** been so designated is solely at the Buyer's risk, and that Buyer is solely responsible for compliance with all legal and regulatory requirements in connection with such use.

TI has specifically designated certain components as meeting ISO/TS16949 requirements, mainly for automotive use. In any case of use of non-designated products, TI will not be responsible for any failure to meet ISO/TS16949.

### Products

Audio	<a href="http://www.ti.com/audio">www.ti.com/audio</a>
Amplifiers	<a href="http://amplifier.ti.com">amplifier.ti.com</a>
Data Converters	<a href="http://dataconverter.ti.com">dataconverter.ti.com</a>
DLP® Products	<a href="http://www.dlp.com">www.dlp.com</a>
DSP	<a href="http://dsp.ti.com">dsp.ti.com</a>
Clocks and Timers	<a href="http://www.ti.com/clocks">www.ti.com/clocks</a>
Interface	<a href="http://interface.ti.com">interface.ti.com</a>
Logic	<a href="http://logic.ti.com">logic.ti.com</a>
Power Mgmt	<a href="http://power.ti.com">power.ti.com</a>
Microcontrollers	<a href="http://microcontroller.ti.com">microcontroller.ti.com</a>
RFID	<a href="http://www.ti-rfid.com">www.ti-rfid.com</a>
OMAP Applications Processors	<a href="http://www.ti.com/omap">www.ti.com/omap</a>
Wireless Connectivity	<a href="http://www.ti.com/wirelessconnectivity">www.ti.com/wirelessconnectivity</a>

### Applications

Automotive and Transportation	<a href="http://www.ti.com/automotive">www.ti.com/automotive</a>
Communications and Telecom	<a href="http://www.ti.com/communications">www.ti.com/communications</a>
Computers and Peripherals	<a href="http://www.ti.com/computers">www.ti.com/computers</a>
Consumer Electronics	<a href="http://www.ti.com/consumer-apps">www.ti.com/consumer-apps</a>
Energy and Lighting	<a href="http://www.ti.com/energy">www.ti.com/energy</a>
Industrial	<a href="http://www.ti.com/industrial">www.ti.com/industrial</a>
Medical	<a href="http://www.ti.com/medical">www.ti.com/medical</a>
Security	<a href="http://www.ti.com/security">www.ti.com/security</a>
Space, Avionics and Defense	<a href="http://www.ti.com/space-avionics-defense">www.ti.com/space-avionics-defense</a>
Video and Imaging	<a href="http://www.ti.com/video">www.ti.com/video</a>

### TI E2E Community

[e2e.ti.com](http://e2e.ti.com)