

## LM2936 Ultra-Low Quiescent Current LDO Voltage Regulator

Check for Samples: [LM2936](#)

### FEATURES

- Ultra Low Quiescent Current ( $I_Q \leq 15 \mu\text{A}$  for  $I_O = 100 \mu\text{A}$ )
- Fixed 3.0V, 3.3V or 5.0V with 50 mA Output
- $\pm 2\%$  Initial Output Tolerance
- $\pm 3\%$  Output Tolerance Over Line, Load, and Temperature
- Dropout Voltage Typically 200 mV @  $I_O = 50 \text{ mA}$
- Reverse Battery Protection
- $-50\text{V}$  Reverse Transient Protection
- Internal Short Circuit Current Limit
- Internal Thermal Shutdown Protection
- 40V Operating Voltage Limit
- 60V Operating Voltage Limit for LM2936HV
- Shutdown Pin Available with LM2936BM Package

### DESCRIPTION

The LM2936 ultra-low quiescent current regulator features low dropout voltage and low current in the standby mode. With less than  $15 \mu\text{A}$  quiescent current at a  $100 \mu\text{A}$  load, the LM2936 is ideally suited for automotive and other battery operated systems. The LM2936 retains all of the features that are common to low dropout regulators including a low dropout PNP pass device, short circuit protection, reverse battery protection, and thermal shutdown. The LM2936 has a 40V maximum operating voltage limit, a  $-40^\circ\text{C}$  to  $+125^\circ\text{C}$  operating temperature range, and  $\pm 3\%$  output voltage tolerance over the entire output current, input voltage, and temperature range. The LM2936 is available in a TO-92 package, SOIC-8 and SOT-223 surface mount packages, and a PFM surface mount power package.

### Typical Application

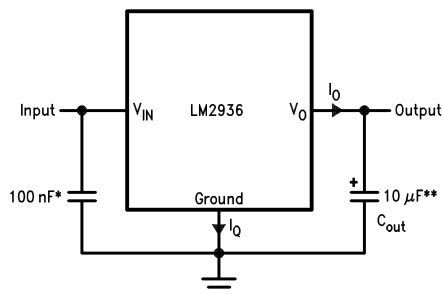

\* Required if regulator is located more than 2" from power supply filter capacitor.

\*\* Required for stability. See [Electrical Characteristics](#) for required values. Must be rated over intended operating temperature range. Effective series resistance (ESR) is critical, see curve. Locate capacitor as close as possible to the regulator output and ground pins. Capacitance may be increased without bound.



Please be aware that an important notice concerning availability, standard warranty, and use in critical applications of Texas Instruments semiconductor products and disclaimers thereto appears at the end of this data sheet.

All trademarks are the property of their respective owners.

## Connection Diagrams

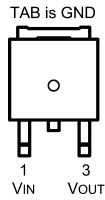

**Figure 1. PFM  
Top View**  
See Package Number NDP0003B

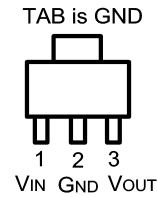

**Figure 2. SOT-223  
Top View**  
See Package Number DCY0004A

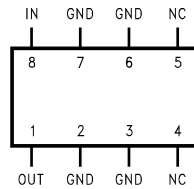

**Figure 3. 8-Pin SOIC (D)  
Top View**  
See Package Number D0008A

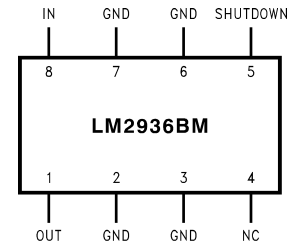

**Figure 4. 8-Pin SOIC (D)  
Top View**  
See Package Number D0008A

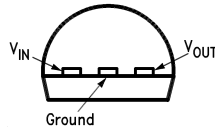

**Figure 5. TO-92  
Bottom View**  
See Package Number LP0003A

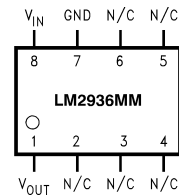

**Figure 6. 8-Pin VSSOP (DGK)  
Top View**  
See Package Number DGK0008A



These devices have limited built-in ESD protection. The leads should be shorted together or the device placed in conductive foam during storage or handling to prevent electrostatic damage to the MOS gates.

## Absolute Maximum Ratings <sup>(1)(2)</sup>

Input Voltage (Survival)	+60V, -50V
ESD Susceptibility <sup>(3)</sup>	2000V
Power Dissipation <sup>(4)</sup>	Internally limited
Junction Temperature (T <sub>Jmax</sub> )	150°C
Storage Temperature Range	-65°C to +150°C
Lead Temperature (Soldering, 10 sec.)	260°C

- (1) Absolute Maximum Ratings indicate limits beyond which damage to the device may occur. DC and AC electrical specifications do not apply when operating the device beyond its specified operating ratings.
- (2) If Military/Aerospace specified devices are required, please contact the TI Sales Office/ Distributors for availability and specifications.
- (3) Human body model, 100 pF discharge through a 1.5 kΩ resistor.
- (4) The maximum power dissipation is a function of T<sub>Jmax</sub>, θ<sub>JA</sub>, and T<sub>A</sub>. The maximum allowable power dissipation at any ambient temperature is P<sub>D</sub> = (T<sub>Jmax</sub> - T<sub>A</sub>)/θ<sub>JA</sub>. If this dissipation is exceeded, the die temperature will rise above 150°C and the LM2936 will go into thermal shutdown.

## Operating Ratings

Operating Temperature Range	-40°C to +125°C
Maximum Operating Input Voltage - LM2936	+40V
Maximum Operating Input Voltage - LM2936HV only	+60V
Maximum Shutdown Pin Voltage - LM2936BM only	0V to 40V
TO-92 (LP0003A) $\theta_{JA}$	195°C/W
VSSOP-8 (DGK0008A) $\theta_{JA}$	200°C/W
SOIC-8 (D0008A) $\theta_{JA}$	140°C/W
SOIC-8 (D0008A) $\theta_{JC}$	45°C/W
PFM (NDP0003B) $\theta_{JA}$	136°C/W
PFM (NDP0003B) $\theta_{JC}$	6°C/W
SOT-223 (DCY0004A) $\theta_{JA}$	149°C/W
SOT-223 (DCY0004A) $\theta_{JC}$	36°C/W

## Electrical Characteristics for LM2936–3.0

$V_{IN} = 14V$ ,  $I_O = 10\text{ mA}$ ,  $T_J = 25^\circ\text{C}$ , unless otherwise specified. **Boldface** limits apply over entire operating temperature range

Parameter	Conditions	Min (1)	Typical (2)	Max (1)	Units
<b>LM2936HV–3.0 Only</b>					
Output Voltage	$5.5V \leq V_{IN} \leq 48V$ , $100\ \mu\text{A} \leq I_O \leq 50\ \text{mA}$ (3)	<b>2.910</b>	<b>3.000</b>	<b>3.090</b>	V
Line Regulation	$6V \leq V_{IN} \leq 60V$ , $I_O = 1\text{ mA}$		10	30	mV
<b>All LM2936–3.0</b>					
Output Voltage	$4.0V \leq V_{IN} \leq 26V$ , $100\ \mu\text{A} \leq I_O \leq 50\ \text{mA}$ (3)	2.940	3.000	3.060	V
		<b>2.910</b>	<b>3.000</b>	<b>3.090</b>	
Quiescent Current	$I_O = 100\ \mu\text{A}$ , $8V \leq V_{IN} \leq 24V$		15	20	$\mu\text{A}$
	$I_O = 10\ \text{mA}$ , $8V \leq V_{IN} \leq 24V$		0.20	0.50	mA
	$I_O = 50\ \text{mA}$ , $8V \leq V_{IN} \leq 24V$		1.5	2.5	mA
Line Regulation	$9V \leq V_{IN} \leq 16V$		5	10	mV
	$6V \leq V_{IN} \leq 40V$ , $I_O = 1\ \text{mA}$		10	30	
Load Regulation	$100\ \mu\text{A} \leq I_O \leq 5\ \text{mA}$		10	30	mV
	$5\ \text{mA} \leq I_O \leq 50\ \text{mA}$		10	30	
Dropout Voltage	$I_O = 100\ \mu\text{A}$		0.05	0.10	V
	$I_O = 50\ \text{mA}$		0.20	0.40	V
Short Circuit Current	$V_O = 0V$	65	120	250	mA
Output Impedance	$I_O = 30\ \text{mAdc}$ and $10\ \text{mArms}$ , $f = 1000\ \text{Hz}$		450		$\text{m}\Omega$
Output Noise Voltage	10 Hz–100 kHz		500		$\mu\text{V}$
Long Term Stability			20		mV/1000 Hr
Ripple Rejection	$V_{\text{ripple}} = 1V_{\text{rms}}$ , $f_{\text{ripple}} = 120\ \text{Hz}$	-40	-60		dB
Reverse Polarity Transient Input Voltage	$R_L = 500\ \Omega$ , $T = 1\ \text{ms}$	-50	-80		V
Output Voltage with Reverse Polarity Input	$V_{IN} = -15V$ , $R_L = 500\ \Omega$		0.00	-0.30	V
Maximum Line Transient	$R_L = 500\ \Omega$ , $V_O \leq 3.30V$ , $T = 40\ \text{ms}$	60			V
Output Bypass Capacitance ( $C_{OUT}$ ) ESR	$C_{OUT} = 22\ \mu\text{F}$ $0.1\ \text{mA} \leq I_{OUT} \leq 50\ \text{mA}$	0.3		8	$\Omega$
<b>Shutdown Input – LM2936BM–3.0 Only</b>					

(1) Datasheet min/max specification limits are ensured by design, test, or statistical analysis.

(2) Typicals are at 25°C (unless otherwise specified) and represent the most likely parametric norm.

(3) To ensure constant junction temperature, pulse testing is used.

### Electrical Characteristics for LM2936–3.0 (continued)

$V_{IN} = 14V$ ,  $I_O = 10\text{ mA}$ ,  $T_J = 25^\circ\text{C}$ , unless otherwise specified. **Boldface** limits apply over entire operating temperature range

Parameter	Conditions	Min (1)	Typical (2)	Max (1)	Units
Output Voltage, $V_{OUT}$	Output Off, $V_{SD}=2.4V$ , $R_{LOAD} = 500\Omega$		0	0.010	V
Shutdown High Threshold Voltage, $V_{IH}$	Output Off, $R_{LOAD} = 500\Omega$	2.00	1.1		V
Shutdown Low Threshold Voltage, $V_{IL}$	Output On, $R_{LOAD} = 500\Omega$		1.1	0.60	V
Shutdown High Current, $I_{IH}$	Output Off, $V_{SD} = 2.4V$ , $R_{LOAD} = 500\Omega$		12		$\mu\text{A}$
Quiescent Current	Output Off, $V_{SD} = 2.4V$ , $R_{LOAD} = 500\Omega$ Includes $I_{IH}$ Current		30		$\mu\text{A}$

### Electrical Characteristics for LM2936–3.3

$V_{IN} = 14V$ ,  $I_O = 10\text{ mA}$ ,  $T_J = 25^\circ\text{C}$ , unless otherwise specified. **Boldface** limits apply over entire operating temperature range

Parameter	Conditions	Min (1)	Typical (2)	Max (1)	Units
<b>LM2936HV–3.3 Only</b>					
Output Voltage	$5.5V \leq V_{IN} \leq 48V$ , $100\ \mu\text{A} \leq I_O \leq 50\text{ mA}$ (3)	<b>3.201</b>	<b>3.300</b>	<b>3.399</b>	V
Line Regulation	$6V \leq V_{IN} \leq 60V$ , $I_O = 1\text{ mA}$		10	30	mV
<b>All LM2936–3.3</b>					
Output Voltage	$4.0V \leq V_{IN} \leq 26V$ , $100\ \mu\text{A} \leq I_O \leq 50\text{ mA}$ (3)	<b>3.234</b>	3.300	3.366	V
Quiescent Current	$I_O = 100\ \mu\text{A}$ , $8V \leq V_{IN} \leq 24V$		15	20	
	$I_O = 10\text{ mA}$ , $8V \leq V_{IN} \leq 24V$		0.20	0.50	mA
	$I_O = 50\text{ mA}$ , $8V \leq V_{IN} \leq 24V$		1.5	2.5	mA
Line Regulation	$9V \leq V_{IN} \leq 16V$		5	10	mV
	$6V \leq V_{IN} \leq 40V$ , $I_O = 1\text{ mA}$		10	30	
Load Regulation	$100\ \mu\text{A} \leq I_O \leq 5\text{ mA}$		10	30	mV
	$5\text{ mA} \leq I_O \leq 50\text{ mA}$		10	30	
Dropout Voltage	$I_O = 100\ \mu\text{A}$		0.05	0.10	V
	$I_O = 50\text{ mA}$		0.20	0.40	V
Short Circuit Current	$V_O = 0V$	65	120	250	mA
Output Impedance	$I_O = 30\text{ mAdc}$ and $10\text{ mArms}$ , $f = 1000\text{ Hz}$		450		m $\Omega$
Output Noise Voltage	10 Hz–100 kHz		500		$\mu\text{V}$
Long Term Stability			20		mV/1000 Hr
Ripple Rejection	$V_{\text{ripple}} = 1V_{\text{rms}}$ , $f_{\text{ripple}} = 120\text{ Hz}$	-40	-60		dB
Reverse Polarity Transient Input Voltage	$R_L = 500\Omega$ , $T = 1\text{ ms}$	-50	-80		V
Output Voltage with Reverse Polarity Input	$V_{IN} = -15V$ , $R_L = 500\Omega$		0.00	-0.30	V
Maximum Line Transient	$R_L = 500\Omega$ , $V_O \leq 3.63V$ , $T = 40\text{ms}$	60			V
Output Bypass Capacitance ( $C_{OUT}$ ) ESR	$C_{OUT} = 22\ \mu\text{F}$ $0.1\text{ mA} \leq I_{OUT} \leq 50\text{ mA}$	0.3		8	$\Omega$
<b>Shutdown Input – LM2936BM–3.3 Only</b>					
Output Voltage, $V_{OUT}$	Output Off, $V_{SD}=2.4V$ , $R_{LOAD} = 500\Omega$		0	0.010	V

(1) Datasheet min/max specification limits are ensured by design, test, or statistical analysis.

(2) Typicals are at  $25^\circ\text{C}$  (unless otherwise specified) and represent the most likely parametric norm.

(3) To ensure constant junction temperature, pulse testing is used.

**Electrical Characteristics for LM2936–3.3 (continued)**
 $V_{IN} = 14V$ ,  $I_O = 10\text{ mA}$ ,  $T_J = 25^\circ\text{C}$ , unless otherwise specified. **Boldface** limits apply over entire operating temperature range

Parameter	Conditions	Min (1)	Typical (2)	Max (1)	Units
Shutdown High Threshold Voltage, $V_{IH}$	Output Off, $R_{LOAD} = 500\Omega$	2.00	1.1		V
Shutdown Low Threshold Voltage, $V_{IL}$	Output On, $R_{LOAD} = 500\Omega$		1.1	0.60	V
Shutdown High Current, $I_{IH}$	Output Off, $V_{SD} = 2.4V$ , $R_{LOAD} = 500\Omega$		12		$\mu\text{A}$
Quiescent Current	Output Off, $V_{SD} = 2.4V$ , $R_{LOAD} = 500\Omega$ Includes $I_{IH}$ Current		30		$\mu\text{A}$

**Electrical Characteristics for LM2936–5.0**
 $V_{IN} = 14V$ ,  $I_O = 10\text{ mA}$ ,  $T_J = 25^\circ\text{C}$ , unless otherwise specified. **Boldface** limits apply over entire operating temperature range

Parameter	Conditions	Min (1)	Typical (2)	Max (1)	Units
<b>LM2936HV–5.0 Only</b>					
Output Voltage	$5.5V \leq V_{IN} \leq 48V$ , $100\ \mu\text{A} \leq I_O \leq 50\text{ mA}$ (3)	<b>4.85</b>	<b>5.00</b>	<b>5.15</b>	V
Line Regulation	$6V \leq V_{IN} \leq 60V$ , $I_O = 1\text{ mA}$		15	35	mV
<b>All LM2936–5.0</b>					
Output Voltage	$5.5V \leq V_{IN} \leq 26V$ , $100\ \mu\text{A} \leq I_O \leq 50\text{ mA}$ (3)	4.90	5.00	5.10	V
		<b>4.85</b>	<b>5.00</b>	<b>5.15</b>	
Quiescent Current	$I_O = 100\ \mu\text{A}$ , $8V \leq V_{IN} \leq 24V$		9	15	$\mu\text{A}$
	$I_O = 10\text{ mA}$ , $8V \leq V_{IN} \leq 24V$		0.20	0.50	mA
	$I_O = 50\text{ mA}$ , $8V \leq V_{IN} \leq 24V$		1.5	2.5	mA
Line Regulation	$9V \leq V_{IN} \leq 16V$		5	10	mV
	$6V \leq V_{IN} \leq 40V$ , $I_O = 1\text{ mA}$		10	30	
Load Regulation	$100\ \mu\text{A} \leq I_O \leq 5\text{ mA}$		10	30	mV
	$5\text{ mA} \leq I_O \leq 50\text{ mA}$		10	30	
Dropout Voltage	$I_O = 100\ \mu\text{A}$		0.05	0.10	V
	$I_O = 50\text{ mA}$		0.20	0.40	V
Short Circuit Current	$V_O = 0V$	65	120	250	mA
Output Impedance	$I_O = 30\text{ mAdc}$ and $10\text{ mArms}$ , $f = 1000\text{ Hz}$		450		m $\Omega$
Output Noise Voltage	10 Hz–100 kHz		500		$\mu\text{V}$
Long Term Stability			20		mV/1000 Hr
Ripple Rejection	$V_{ripple} = 1V_{rms}$ , $f_{ripple} = 120\text{ Hz}$	-40	-60		dB
Reverse Polarity Transient Input Voltage	$R_L = 500\Omega$ , $T = 1\text{ ms}$	-50	-80		V
Output Voltage with Reverse Polarity Input	$V_{IN} = -15V$ , $R_L = 500\Omega$		0.00	-0.30	V
Maximum Line Transient	$R_L = 500\Omega$ , $V_O \leq 5.5V$ , $T = 40\text{ ms}$	60			V
Output Bypass Capacitance ( $C_{OUT}$ ) ESR	$C_{OUT} = 10\ \mu\text{F}$ $0.1\text{ mA} \leq I_{OUT} \leq 50\text{ mA}$	0.3		8	$\Omega$
<b>Shutdown Input – LM2936BM–5.0 Only</b>					
Output Voltage, $V_{OUT}$	Output Off, $V_{SD} = 2.4V$ , $R_{LOAD} = 500\Omega$		0	0.010	V
Shutdown High Threshold Voltage, $V_{IH}$	Output Off, $R_{LOAD} = 500\Omega$	2.00	1.1		V

(1) Datasheet min/max specification limits are ensured by design, test, or statistical analysis.

(2) Typicals are at  $25^\circ\text{C}$  (unless otherwise specified) and represent the most likely parametric norm.

(3) To ensure constant junction temperature, pulse testing is used.

**Electrical Characteristics for LM2936–5.0 (continued)**
 $V_{IN} = 14V$ ,  $I_O = 10\text{ mA}$ ,  $T_J = 25^\circ\text{C}$ , unless otherwise specified. **Boldface** limits apply over entire operating temperature range

Parameter	Conditions	Min (1)	Typical (2)	Max (1)	Units
Shutdown Low Threshold Voltage, $V_{IL}$	Output On, $R_{LOAD} = 500\Omega$		1.1	0.60	V
Shutdown High Current, $I_{IH}$	Output Off, $V_{SD} = 2.4V$ , $R_{LOAD} = 500\Omega$		12		$\mu\text{A}$
Quiescent Current	Output Off, $V_{SD} = 2.4V$ , $R_{LOAD} = 500\Omega$ Includes $I_{IH}$ Current		30		$\mu\text{A}$

Typical Performance Characteristics

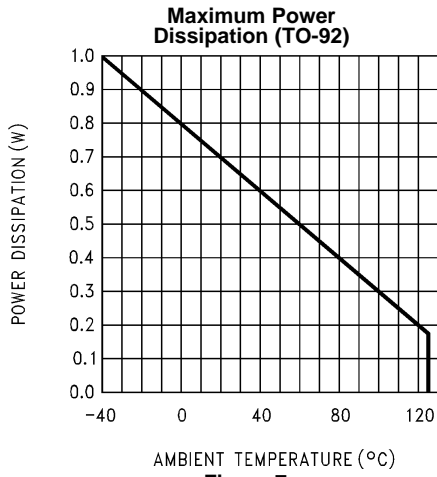

Figure 7.

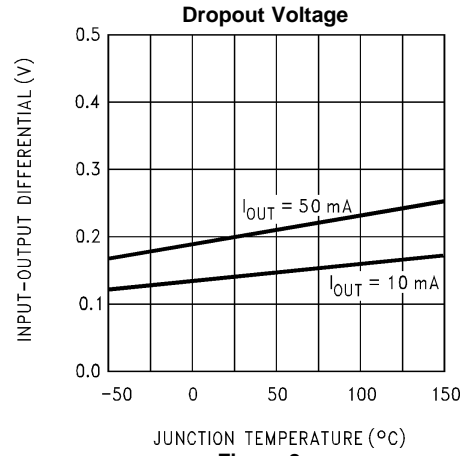

Figure 8.

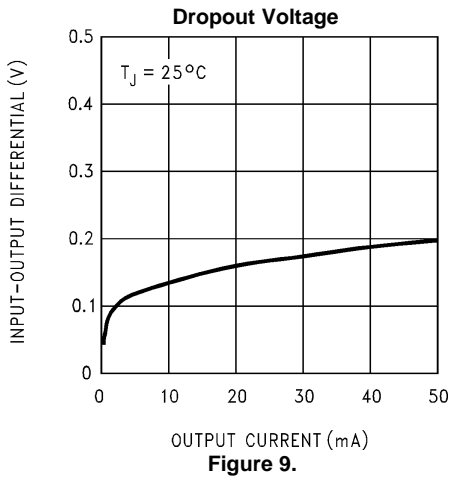

Figure 9.

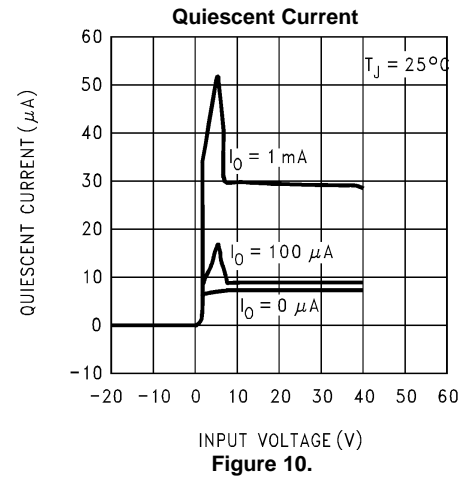

Figure 10.

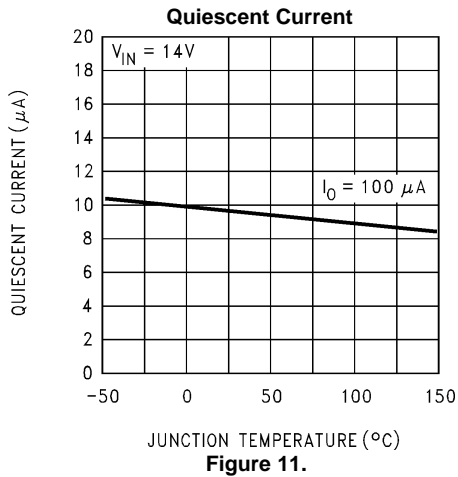

Figure 11.

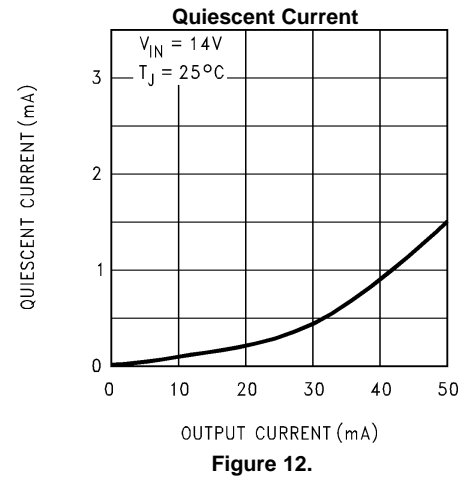

Figure 12.

**Typical Performance Characteristics (continued)**

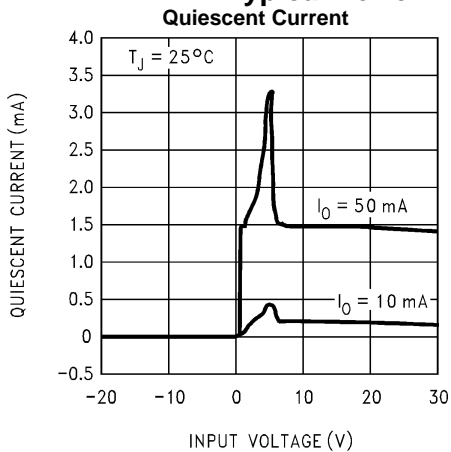

Figure 13.

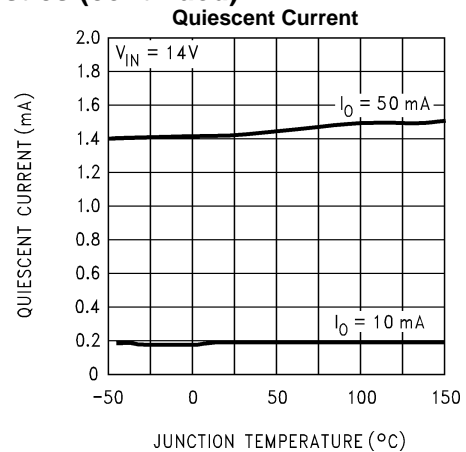

Figure 14.

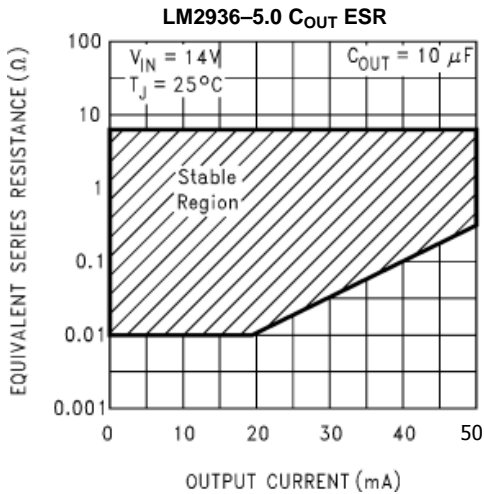

Figure 15.

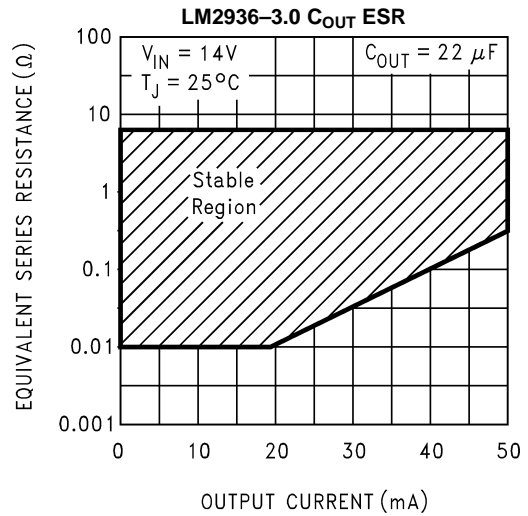

Figure 16.

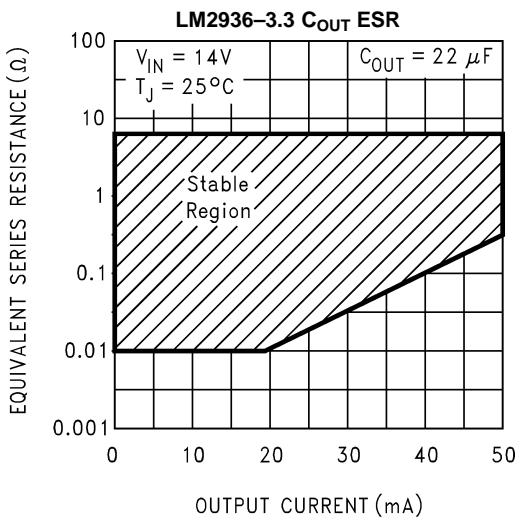

Figure 17.

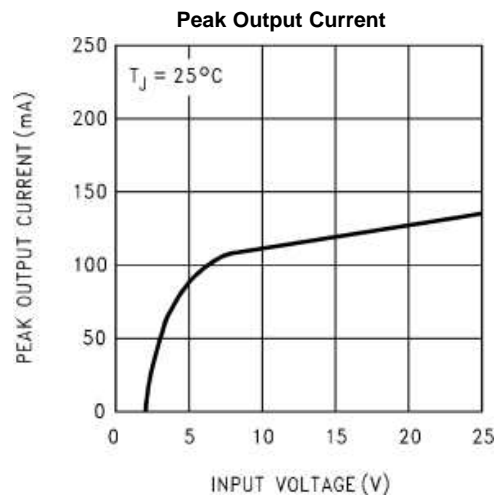

Figure 18.



Typical Performance Characteristics (continued)

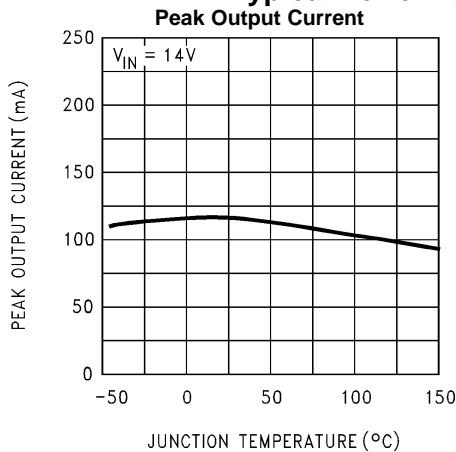

Figure 19.

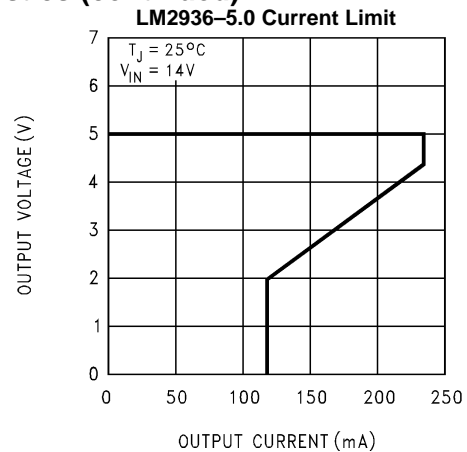

Figure 20.

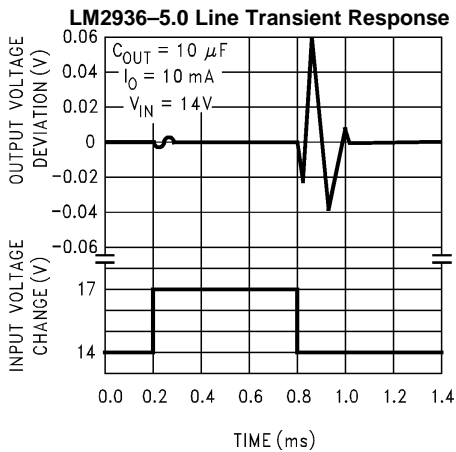

Figure 21.

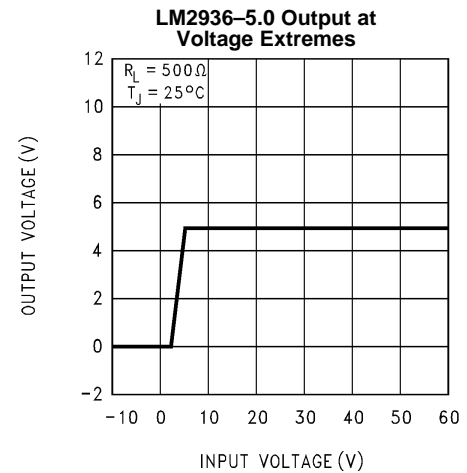

Figure 22.

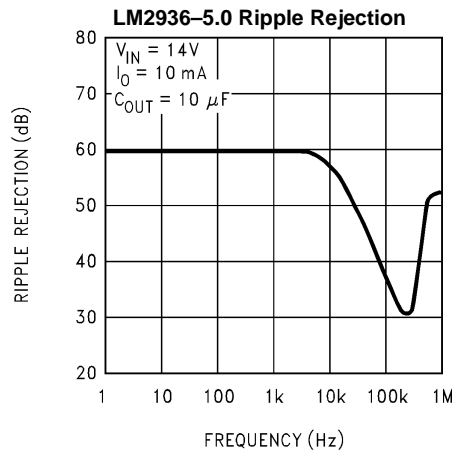

Figure 23.

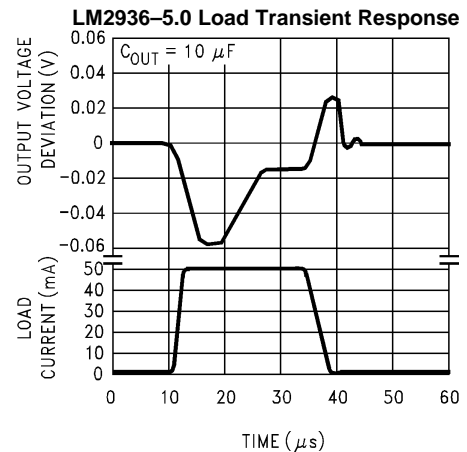
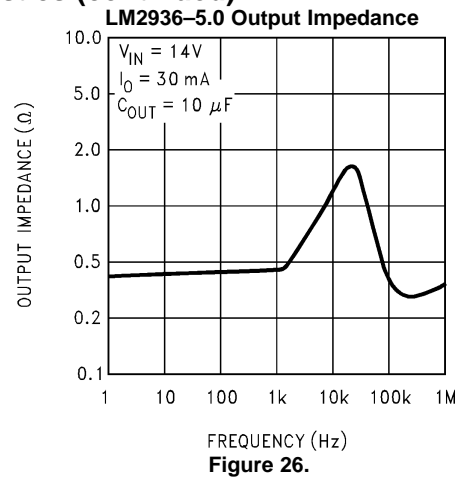
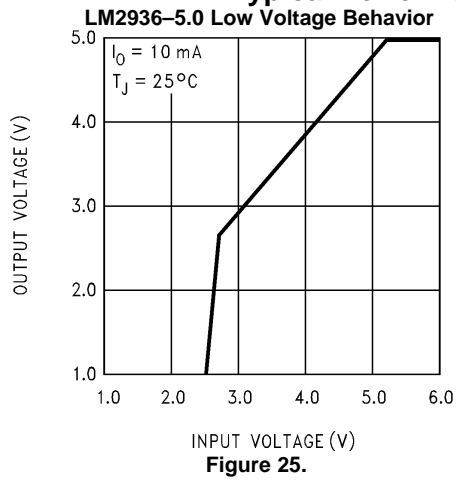

Figure 24.

**Typical Performance Characteristics (continued)**



## APPLICATIONS INFORMATION

Unlike other PNP low dropout regulators, the LM2936 remains fully operational to 40V. Owing to power dissipation characteristics of the available packages, full output current cannot be ensured for all combinations of ambient temperature and input voltage. As an example, consider an LM2936Z–5.0 operating at 25°C ambient. Using the formula for maximum allowable power dissipation given in <sup>(1)</sup>, we find that  $P_{Dmax} = 641 \text{ mW}$  at 25°C. Including the small contribution of the quiescent current to total power dissipation the maximum input voltage (while still delivering 50 mA output current) is 17.3V. The LM2936Z–5.0 will go into thermal shutdown if it attempts to deliver full output current with an input voltage of more than 17.3V. Similarly, at 40V input and 25°C ambient the LM2936Z–5.0 can deliver 18 mA maximum.

Under conditions of higher ambient temperatures, the voltage and current calculated in the previous examples will drop. For instance, at the maximum ambient of 125°C the LM2936Z–5.0 can only dissipate 128 mW, limiting the input voltage to 7.34V for a 50 mA load, or 3.5 mA output current for a 40V input.

The junction to ambient thermal resistance  $\theta_{JA}$  rating has two distinct components: the junction to case thermal resistance rating  $\theta_{JC}$ ; and the case to ambient thermal resistance rating  $\theta_{CA}$ . The relationship is defined as:  $\theta_{JA} = \theta_{JC} + \theta_{CA}$ .

For the SOIC-8 and PFM surface mount packages the  $\theta_{JA}$  rating can be improved by using the copper mounting pads on the printed circuit board as a thermal conductive path to extract heat from the package.

On the SOIC-8 package the four ground pins are thermally connected to the backside of the die. Adding approximately 0.04 square inches of 2 oz. copper pad area to these four pins will improve the  $\theta_{JA}$  rating to approximately 110°C/W. If this extra pad are is placed directly beneath the package there should not be any impact on board density.

On the PFM package the ground tab is thermally connected to the backside of the die. Adding 1 square inch of 2 oz. copper pad area directly under the ground tab will improve the  $\theta_{JA}$  rating to approximately 50°C/W.

While the LM2936 has an internally set thermal shutdown point of typically 160°C, this is intended as a safety feature only. Continuous operation near the thermal shutdown temperature should be avoided as it may have a negative affect on the life of the device.

While the LM2936 maintains regulation to 60V, it will not withstand a short circuit above 40V because of safe operating area limitations in the internal PNP pass device. Above 60V the LM2936 will break down with catastrophic effects on the regulator and possibly the load as well. Do not use this device in a design where the input operating voltage may exceed 40V, or where transients are likely to exceed 60V.

### SHUTDOWN PIN

The LM2936BM has a pin for shutting down the regulator output. Applying a Logic Level High (>2.0V) to the Shutdown pin will cause the output to turn off. Leaving the Shutdown pin open, connecting it to Ground, or applying a Logic Level Low (<0.6V) will allow the regulator output to turn on.

(1) The maximum power dissipation is a function of  $T_{Jmax}$ ,  $\theta_{JA}$ , and  $T_A$ . The maximum allowable power dissipation at any ambient temperature is  $P_D = (T_{Jmax} - T_A)/\theta_{JA}$ . If this dissipation is exceeded, the die temperature will rise above 150°C and the LM2936 will go into thermal shutdown.

## Equivalent Schematic Diagram

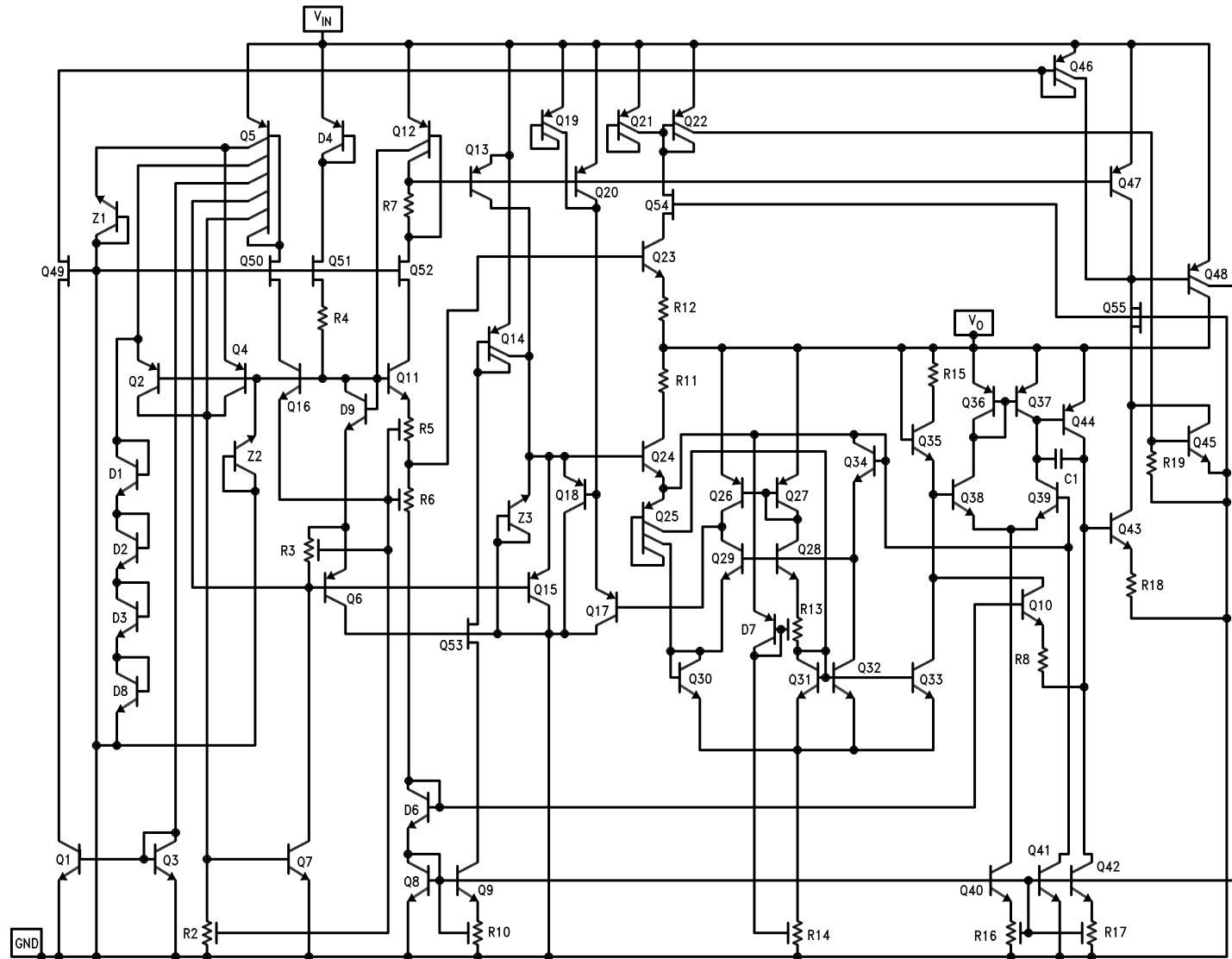

Figure 27.

---

**REVISION HISTORY**

<b>Changes from Revision M (March 2013) to Revision N</b>	<b>Page</b>
<hr/> <ul style="list-style-type: none"><li>• Changed layout of National Data Sheet to TI format .....</li></ul>	<hr/> <a href="#">12</a>

**PACKAGING INFORMATION**

Orderable Device	Status (1)	Package Type	Package Drawing	Pins	Package Qty	Eco Plan (2)	Lead/Ball Finish (6)	MSL Peak Temp (3)	Op Temp (°C)	Device Marking (4/5)	Samples
LM2936BM-3.3/NOPB	ACTIVE	SOIC	D	8	95	Green (RoHS & no Sb/Br)	CU SN	Level-1-260C-UNLIM	-40 to 125	LM2936B3.3	<a href="#">Samples</a>
LM2936BM-5.0/NOPB	ACTIVE	SOIC	D	8	95	Green (RoHS & no Sb/Br)	CU SN	Level-1-260C-UNLIM	-40 to 125	LM2936B5.0	<a href="#">Samples</a>
LM2936BMX-3.3/NOPB	ACTIVE	SOIC	D	8	2500	Green (RoHS & no Sb/Br)	CU SN	Level-1-260C-UNLIM	-40 to 125	LM2936B3.3	<a href="#">Samples</a>
LM2936BMX-5.0	NRND	SOIC	D	8	2500	TBD	Call TI	Call TI	-40 to 125	LM2936B5.0	
LM2936BMX-5.0/NOPB	ACTIVE	SOIC	D	8	2500	Green (RoHS & no Sb/Br)	CU SN	Level-1-260C-UNLIM	-40 to 125	LM2936B5.0	<a href="#">Samples</a>
LM2936DT-3.0	NRND	TO-252	NDP	3	75	TBD	Call TI	Call TI	-40 to 125	LM2936DT-3.0	
LM2936DT-3.0/NOPB	ACTIVE	TO-252	NDP	3	75	Green (RoHS & no Sb/Br)	CU SN	Level-2-260C-1 YEAR	-40 to 125	LM2936DT-3.0	<a href="#">Samples</a>
LM2936DT-3.3/NOPB	ACTIVE	TO-252	NDP	3	75	Green (RoHS & no Sb/Br)	CU SN	Level-2-260C-1 YEAR	-40 to 125	LM2936DT-3.3	<a href="#">Samples</a>
LM2936DT-5.0	NRND	TO-252	NDP	3	75	TBD	Call TI	Call TI	-40 to 125	LM2936DT-5.0	
LM2936DT-5.0/NOPB	ACTIVE	TO-252	NDP	3	75	Green (RoHS & no Sb/Br)	CU SN	Level-2-260C-1 YEAR	-40 to 125	LM2936DT-5.0	<a href="#">Samples</a>
LM2936DTX-3.0/NOPB	ACTIVE	TO-252	NDP	3	2500	Green (RoHS & no Sb/Br)	CU SN	Level-2-260C-1 YEAR	-40 to 125	LM2936DTX-3.0	<a href="#">Samples</a>
LM2936DTX-3.3/NOPB	ACTIVE	TO-252	NDP	3	2500	Green (RoHS & no Sb/Br)	CU SN	Level-2-260C-1 YEAR	-40 to 125	LM2936DTX-3.3	<a href="#">Samples</a>
LM2936DTX-5.0	NRND	TO-252	NDP	3	2500	TBD	Call TI	Call TI	-40 to 125	LM2936DTX-5.0	
LM2936DTX-5.0/NOPB	ACTIVE	TO-252	NDP	3	2500	Green (RoHS & no Sb/Br)	CU SN	Level-2-260C-1 YEAR	-40 to 125	LM2936DTX-5.0	<a href="#">Samples</a>
LM2936HVBMA-3.3	NRND	SOIC	D	8	95	TBD	Call TI	Call TI	-40 to 125	2936HBM3.3	
LM2936HVBMA-3.3/NOPB	ACTIVE	SOIC	D	8	95	Green (RoHS & no Sb/Br)	CU SN	Level-1-260C-UNLIM	-40 to 125	2936HBM3.3	<a href="#">Samples</a>
LM2936HVBMA-5.0	NRND	SOIC	D	8	95	TBD	Call TI	Call TI	-40 to 125	2936HBM5.0	

Orderable Device	Status (1)	Package Type	Package Drawing	Pins	Package Qty	Eco Plan (2)	Lead/Ball Finish (6)	MSL Peak Temp (3)	Op Temp (°C)	Device Marking (4/5)	Samples
LM2936HVBMA-5.0/NOPB	ACTIVE	SOIC	D	8	95	Green (RoHS & no Sb/Br)	CU SN	Level-1-260C-UNLIM	-40 to 125	2936H BM5.0	<a href="#">Samples</a>
LM2936HVBMAX3.3	NRND	SOIC	D	8	2500	TBD	Call TI	Call TI		2936H BM3.3	
LM2936HVBMAX3.3/NOPB	ACTIVE	SOIC	D	8	2500	Green (RoHS & no Sb/Br)	CU SN	Level-1-260C-UNLIM		2936H BM3.3	<a href="#">Samples</a>
LM2936HVBMAX5.0/NOPB	ACTIVE	SOIC	D	8	2500	Green (RoHS & no Sb/Br)	CU SN	Level-1-260C-UNLIM		2936H BM5.0	<a href="#">Samples</a>
LM2936HVMA-5.0	NRND	SOIC	D	8	95	TBD	Call TI	Call TI	-40 to 125	2936H M-5.0	
LM2936HVMA-5.0/NOPB	ACTIVE	SOIC	D	8	95	Green (RoHS & no Sb/Br)	CU SN	Level-1-260C-UNLIM	-40 to 125	2936H M-5.0	<a href="#">Samples</a>
LM2936HVMAX-5.0	NRND	SOIC	D	8	2500	TBD	Call TI	Call TI	-40 to 125	2936H M-5.0	
LM2936HVMAX-5.0/NOPB	ACTIVE	SOIC	D	8	2500	Green (RoHS & no Sb/Br)	CU SN	Level-1-260C-UNLIM	-40 to 125	2936H M-5.0	<a href="#">Samples</a>
LM2936M-3.0/NOPB	ACTIVE	SOIC	D	8	95	Green (RoHS & no Sb/Br)	CU SN	Level-1-260C-UNLIM	-40 to 125	LM293 6M-3	<a href="#">Samples</a>
LM2936M-3.3	NRND	SOIC	D	8	95	TBD	Call TI	Call TI	-40 to 125	LM293 6-3.3	
LM2936M-3.3/NOPB	ACTIVE	SOIC	D	8	95	Green (RoHS & no Sb/Br)	CU SN	Level-1-260C-UNLIM	-40 to 125	LM293 6-3.3	<a href="#">Samples</a>
LM2936M-5.0	NRND	SOIC	D	8	95	TBD	Call TI	Call TI	-40 to 125	LM293 6M-5	
LM2936M-5.0/NOPB	ACTIVE	SOIC	D	8	95	Green (RoHS & no Sb/Br)	CU SN	Level-1-260C-UNLIM	-40 to 125	LM293 6M-5	<a href="#">Samples</a>
LM2936MM-3.0/NOPB	ACTIVE	VSSOP	DGK	8	1000	Green (RoHS & no Sb/Br)	CU SN	Level-1-260C-UNLIM	-40 to 125	KBC	<a href="#">Samples</a>
LM2936MM-3.3	NRND	VSSOP	DGK	8	1000	TBD	Call TI	Call TI	-40 to 125	KBB	
LM2936MM-3.3/NOPB	ACTIVE	VSSOP	DGK	8	1000	Green (RoHS & no Sb/Br)	CU SN	Level-1-260C-UNLIM	-40 to 125	KBB	<a href="#">Samples</a>
LM2936MM-5.0/NOPB	ACTIVE	VSSOP	DGK	8	1000	Green (RoHS & no Sb/Br)	CU SN	Level-1-260C-UNLIM	-40 to 125	KBA	<a href="#">Samples</a>
LM2936MMX-3.3/NOPB	ACTIVE	VSSOP	DGK	8	3500	Green (RoHS & no Sb/Br)	CU SN	Level-1-260C-UNLIM	-40 to 125	KBB	<a href="#">Samples</a>
LM2936MMX-5.0	NRND	VSSOP	DGK	8	3500	TBD	Call TI	Call TI	-40 to 125	KBA	

Orderable Device	Status (1)	Package Type	Package Drawing	Pins	Package Qty	Eco Plan (2)	Lead/Ball Finish (6)	MSL Peak Temp (3)	Op Temp (°C)	Device Marking (4/5)	Samples
LM2936MMX-5.0/NOPB	ACTIVE	VSSOP	DGK	8	3500	Green (RoHS & no Sb/Br)	CU SN	Level-1-260C-UNLIM	-40 to 125	KBA	<a href="#">Samples</a>
LM2936MP-3.0/NOPB	ACTIVE	SOT-223	DCY	4	1000	Green (RoHS & no Sb/Br)	CU SN	Level-1-260C-UNLIM		KACA	<a href="#">Samples</a>
LM2936MP-3.3	NRND	SOT-223	DCY	4	1000	TBD	Call TI	Call TI	-40 to 125	KABA	
LM2936MP-3.3/NOPB	ACTIVE	SOT-223	DCY	4	1000	Green (RoHS & no Sb/Br)	CU SN	Level-1-260C-UNLIM	-40 to 125	KABA	<a href="#">Samples</a>
LM2936MP-5.0	NRND	SOT-223	DCY	4	1000	TBD	Call TI	Call TI	-40 to 125	KAAA	
LM2936MP-5.0/NOPB	ACTIVE	SOT-223	DCY	4	1000	Green (RoHS & no Sb/Br)	CU SN	Level-1-260C-UNLIM	-40 to 125	KAAA	<a href="#">Samples</a>
LM2936MPX-3.0/NOPB	ACTIVE	SOT-223	DCY	4	2000	TBD	Call TI	Call TI	-40 to 125	KACA	<a href="#">Samples</a>
LM2936MPX-3.3/NOPB	ACTIVE	SOT-223	DCY	4	2000	Green (RoHS & no Sb/Br)	CU SN	Level-1-260C-UNLIM	-40 to 125	KABA	<a href="#">Samples</a>
LM2936MPX-5.0/NOPB	ACTIVE	SOT-223	DCY	4	2000	Green (RoHS & no Sb/Br)	CU SN	Level-1-260C-UNLIM	-40 to 125	KAAA	<a href="#">Samples</a>
LM2936MX-3.3	NRND	SOIC	D	8	2500	TBD	Call TI	Call TI	-40 to 125	LM293 6-3.3	
LM2936MX-3.3/NOPB	ACTIVE	SOIC	D	8	2500	Green (RoHS & no Sb/Br)	CU SN	Level-1-260C-UNLIM	-40 to 125	LM293 6-3.3	<a href="#">Samples</a>
LM2936MX-5.0	NRND	SOIC	D	8	2500	TBD	Call TI	Call TI	-40 to 125	LM293 6M-5	
LM2936MX-5.0/NOPB	ACTIVE	SOIC	D	8	2500	Green (RoHS & no Sb/Br)	CU SN	Level-1-260C-UNLIM	-40 to 125	LM293 6M-5	<a href="#">Samples</a>
LM2936Z-3.0/NOPB	ACTIVE	TO-92	LP	3	1800	Green (RoHS & no Sb/Br)	CU SN	N / A for Pkg Type	-40 to 125	LM2936 Z-3	<a href="#">Samples</a>
LM2936Z-3.3/NOPB	ACTIVE	TO-92	LP	3	1800	Green (RoHS & no Sb/Br)	CU SN	N / A for Pkg Type	-40 to 125	LM2936 Z-3.3	<a href="#">Samples</a>
LM2936Z-5.0/LFT1	ACTIVE	TO-92	LP	3	2000	Green (RoHS & no Sb/Br)	CU SN	N / A for Pkg Type		LM293 6Z-5	<a href="#">Samples</a>
LM2936Z-5.0/LFT3	ACTIVE	TO-92	LP	3	2000	Green (RoHS & no Sb/Br)	CU SN	N / A for Pkg Type		LM293 6Z-5	<a href="#">Samples</a>
LM2936Z-5.0/LFT4	ACTIVE	TO-92	LP	3	2000	Green (RoHS & no Sb/Br)	CU SN	N / A for Pkg Type		LM293 6Z-5	<a href="#">Samples</a>
LM2936Z-5.0/NOPB	ACTIVE	TO-92	LP	3	1800	Green (RoHS & no Sb/Br)	CU SN	N / A for Pkg Type	-40 to 125	LM293 6Z-5	<a href="#">Samples</a>



(1) The marketing status values are defined as follows:

**ACTIVE:** Product device recommended for new designs.

**LIFEBUY:** TI has announced that the device will be discontinued, and a lifetime-buy period is in effect.

**NRND:** Not recommended for new designs. Device is in production to support existing customers, but TI does not recommend using this part in a new design.

**PREVIEW:** Device has been announced but is not in production. Samples may or may not be available.

**OBSOLETE:** TI has discontinued the production of the device.

(2) Eco Plan - The planned eco-friendly classification: Pb-Free (RoHS), Pb-Free (RoHS Exempt), or Green (RoHS & no Sb/Br) - please check <http://www.ti.com/productcontent> for the latest availability information and additional product content details.

**TBD:** The Pb-Free/Green conversion plan has not been defined.

**Pb-Free (RoHS):** TI's terms "Lead-Free" or "Pb-Free" mean semiconductor products that are compatible with the current RoHS requirements for all 6 substances, including the requirement that lead not exceed 0.1% by weight in homogeneous materials. Where designed to be soldered at high temperatures, TI Pb-Free products are suitable for use in specified lead-free processes.

**Pb-Free (RoHS Exempt):** This component has a RoHS exemption for either 1) lead-based flip-chip solder bumps used between the die and package, or 2) lead-based die adhesive used between the die and leadframe. The component is otherwise considered Pb-Free (RoHS compatible) as defined above.

**Green (RoHS & no Sb/Br):** TI defines "Green" to mean Pb-Free (RoHS compatible), and free of Bromine (Br) and Antimony (Sb) based flame retardants (Br or Sb do not exceed 0.1% by weight in homogeneous material)

(3) MSL, Peak Temp. - The Moisture Sensitivity Level rating according to the JEDEC industry standard classifications, and peak solder temperature.

(4) There may be additional marking, which relates to the logo, the lot trace code information, or the environmental category on the device.

(5) Multiple Device Markings will be inside parentheses. Only one Device Marking contained in parentheses and separated by a "~" will appear on a device. If a line is indented then it is a continuation of the previous line and the two combined represent the entire Device Marking for that device.

(6) Lead/Ball Finish - Orderable Devices may have multiple material finish options. Finish options are separated by a vertical ruled line. Lead/Ball Finish values may wrap to two lines if the finish value exceeds the maximum column width.

**Important Information and Disclaimer:** The information provided on this page represents TI's knowledge and belief as of the date that it is provided. TI bases its knowledge and belief on information provided by third parties, and makes no representation or warranty as to the accuracy of such information. Efforts are underway to better integrate information from third parties. TI has taken and continues to take reasonable steps to provide representative and accurate information but may not have conducted destructive testing or chemical analysis on incoming materials and chemicals. TI and TI suppliers consider certain information to be proprietary, and thus CAS numbers and other limited information may not be available for release.

In no event shall TI's liability arising out of such information exceed the total purchase price of the TI part(s) at issue in this document sold by TI to Customer on an annual basis.

**TAPE AND REEL INFORMATION**

**QUADRANT ASSIGNMENTS FOR PIN 1 ORIENTATION IN TAPE**

\*All dimensions are nominal

Device	Package Type	Package Drawing	Pins	SPQ	Reel Diameter (mm)	Reel Width W1 (mm)	A0 (mm)	B0 (mm)	K0 (mm)	P1 (mm)	W (mm)	Pin1 Quadrant
LM2936BMX-3.3/NOPB	SOIC	D	8	2500	330.0	12.4	6.5	5.4	2.0	8.0	12.0	Q1
LM2936BMX-5.0	SOIC	D	8	2500	330.0	12.4	6.5	5.4	2.0	8.0	12.0	Q1
LM2936BMX-5.0/NOPB	SOIC	D	8	2500	330.0	12.4	6.5	5.4	2.0	8.0	12.0	Q1
LM2936DTX-3.0/NOPB	TO-252	NDP	3	2500	330.0	16.4	6.9	10.5	2.7	8.0	16.0	Q2
LM2936DTX-3.3/NOPB	TO-252	NDP	3	2500	330.0	16.4	6.9	10.5	2.7	8.0	16.0	Q2
LM2936DTX-5.0	TO-252	NDP	3	2500	330.0	16.4	6.9	10.5	2.7	8.0	16.0	Q2
LM2936DTX-5.0/NOPB	TO-252	NDP	3	2500	330.0	16.4	6.9	10.5	2.7	8.0	16.0	Q2
LM2936HVBMAX3.3	SOIC	D	8	2500	330.0	12.4	6.5	5.4	2.0	8.0	12.0	Q1
LM2936HVBMAX3.3/NOPB	SOIC	D	8	2500	330.0	12.4	6.5	5.4	2.0	8.0	12.0	Q1
LM2936HVBMAX5.0/NOPB	SOIC	D	8	2500	330.0	12.4	6.5	5.4	2.0	8.0	12.0	Q1
LM2936HVBMAX-5.0	SOIC	D	8	2500	330.0	12.4	6.5	5.4	2.0	8.0	12.0	Q1
LM2936HVBMAX-5.0/NOPB	SOIC	D	8	2500	330.0	12.4	6.5	5.4	2.0	8.0	12.0	Q1
LM2936MM-3.0/NOPB	VSSOP	DGK	8	1000	178.0	12.4	5.3	3.4	1.4	8.0	12.0	Q1
LM2936MM-3.3	VSSOP	DGK	8	1000	178.0	12.4	5.3	3.4	1.4	8.0	12.0	Q1
LM2936MM-3.3/NOPB	VSSOP	DGK	8	1000	178.0	12.4	5.3	3.4	1.4	8.0	12.0	Q1
LM2936MM-5.0/NOPB	VSSOP	DGK	8	1000	178.0	12.4	5.3	3.4	1.4	8.0	12.0	Q1

Device	Package Type	Package Drawing	Pins	SPQ	Reel Diameter (mm)	Reel Width W1 (mm)	A0 (mm)	B0 (mm)	K0 (mm)	P1 (mm)	W (mm)	Pin1 Quadrant
LM2936MMX-3.3/NOPB	VSSOP	DGK	8	3500	330.0	12.4	5.3	3.4	1.4	8.0	12.0	Q1
LM2936MMX-5.0	VSSOP	DGK	8	3500	330.0	12.4	5.3	3.4	1.4	8.0	12.0	Q1
LM2936MMX-5.0/NOPB	VSSOP	DGK	8	3500	330.0	12.4	5.3	3.4	1.4	8.0	12.0	Q1
LM2936MP-3.0/NOPB	SOT-223	DCY	4	1000	330.0	16.4	7.0	7.5	2.2	12.0	16.0	Q3
LM2936MP-3.3	SOT-223	DCY	4	1000	330.0	16.4	7.0	7.5	2.2	12.0	16.0	Q3
LM2936MP-3.3/NOPB	SOT-223	DCY	4	1000	330.0	16.4	7.0	7.5	2.2	12.0	16.0	Q3
LM2936MP-5.0	SOT-223	DCY	4	1000	330.0	16.4	7.0	7.5	2.2	12.0	16.0	Q3
LM2936MP-5.0/NOPB	SOT-223	DCY	4	1000	330.0	16.4	7.0	7.5	2.2	12.0	16.0	Q3
LM2936MPX-3.3/NOPB	SOT-223	DCY	4	2000	330.0	16.4	7.0	7.5	2.2	12.0	16.0	Q3
LM2936MPX-5.0/NOPB	SOT-223	DCY	4	2000	330.0	16.4	7.0	7.5	2.2	12.0	16.0	Q3
LM2936MX-3.3	SOIC	D	8	2500	330.0	12.4	6.5	5.4	2.0	8.0	12.0	Q1
LM2936MX-3.3/NOPB	SOIC	D	8	2500	330.0	12.4	6.5	5.4	2.0	8.0	12.0	Q1
LM2936MX-5.0	SOIC	D	8	2500	330.0	12.4	6.5	5.4	2.0	8.0	12.0	Q1
LM2936MX-5.0/NOPB	SOIC	D	8	2500	330.0	12.4	6.5	5.4	2.0	8.0	12.0	Q1

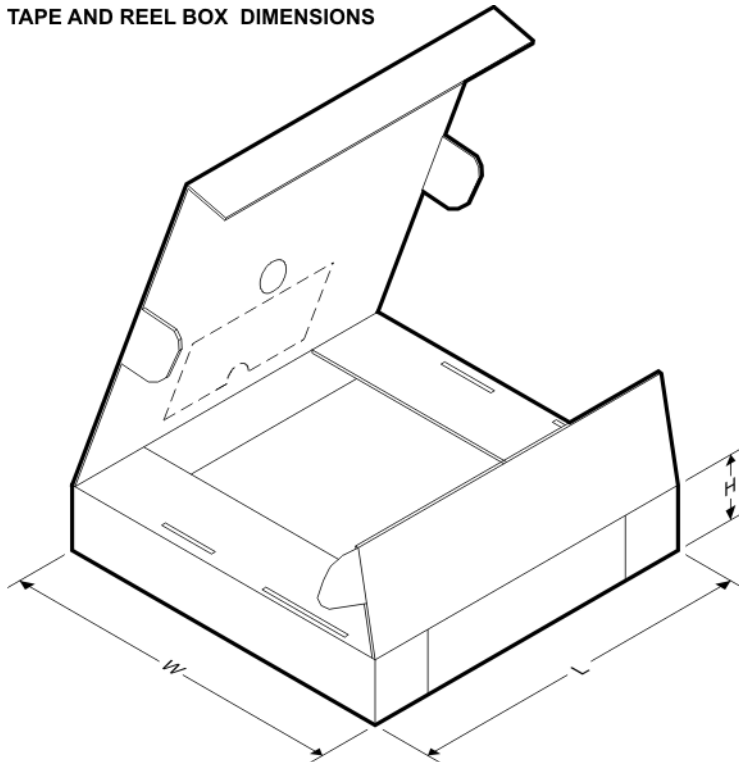
**TAPE AND REEL BOX DIMENSIONS**

\*All dimensions are nominal

Device	Package Type	Package Drawing	Pins	SPQ	Length (mm)	Width (mm)	Height (mm)
LM2936BMX-3.3/NOPB	SOIC	D	8	2500	367.0	367.0	35.0
LM2936BMX-5.0	SOIC	D	8	2500	367.0	367.0	35.0
LM2936BMX-5.0/NOPB	SOIC	D	8	2500	367.0	367.0	35.0

Device	Package Type	Package Drawing	Pins	SPQ	Length (mm)	Width (mm)	Height (mm)
LM2936DTX-3.0/NOPB	TO-252	NDP	3	2500	367.0	367.0	38.0
LM2936DTX-3.3/NOPB	TO-252	NDP	3	2500	367.0	367.0	38.0
LM2936DTX-5.0	TO-252	NDP	3	2500	367.0	367.0	35.0
LM2936DTX-5.0/NOPB	TO-252	NDP	3	2500	367.0	367.0	38.0
LM2936HVBMAX3.3	SOIC	D	8	2500	367.0	367.0	35.0
LM2936HVBMAX3.3/NOPB	SOIC	D	8	2500	367.0	367.0	35.0
LM2936HVBMAX5.0/NOPB	SOIC	D	8	2500	367.0	367.0	35.0
LM2936HVMAX-5.0	SOIC	D	8	2500	367.0	367.0	35.0
LM2936HVMAX-5.0/NOPB	SOIC	D	8	2500	367.0	367.0	35.0
LM2936MM-3.0/NOPB	VSSOP	DGK	8	1000	210.0	185.0	35.0
LM2936MM-3.3	VSSOP	DGK	8	1000	210.0	185.0	35.0
LM2936MM-3.3/NOPB	VSSOP	DGK	8	1000	210.0	185.0	35.0
LM2936MM-5.0/NOPB	VSSOP	DGK	8	1000	210.0	185.0	35.0
LM2936MMX-3.3/NOPB	VSSOP	DGK	8	3500	367.0	367.0	35.0
LM2936MMX-5.0	VSSOP	DGK	8	3500	367.0	367.0	35.0
LM2936MMX-5.0/NOPB	VSSOP	DGK	8	3500	367.0	367.0	35.0
LM2936MP-3.0/NOPB	SOT-223	DCY	4	1000	367.0	367.0	35.0
LM2936MP-3.3	SOT-223	DCY	4	1000	367.0	367.0	35.0
LM2936MP-3.3/NOPB	SOT-223	DCY	4	1000	367.0	367.0	35.0
LM2936MP-5.0	SOT-223	DCY	4	1000	367.0	367.0	35.0
LM2936MP-5.0/NOPB	SOT-223	DCY	4	1000	367.0	367.0	35.0
LM2936MPX-3.3/NOPB	SOT-223	DCY	4	2000	367.0	367.0	35.0
LM2936MPX-5.0/NOPB	SOT-223	DCY	4	2000	367.0	367.0	35.0
LM2936MX-3.3	SOIC	D	8	2500	367.0	367.0	35.0
LM2936MX-3.3/NOPB	SOIC	D	8	2500	367.0	367.0	35.0
LM2936MX-5.0	SOIC	D	8	2500	367.0	367.0	35.0
LM2936MX-5.0/NOPB	SOIC	D	8	2500	367.0	367.0	35.0

NDP0003B

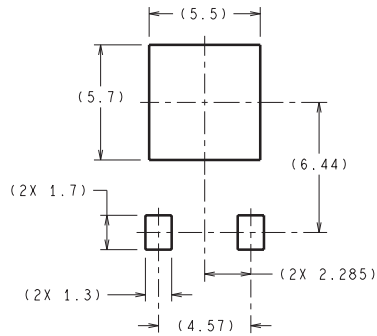

DIMENSIONS ARE IN MILLIMETERS  
DIMENSIONS IN ( ) FOR REFERENCE ONLY

LAND PATTERN RECOMMENDATION

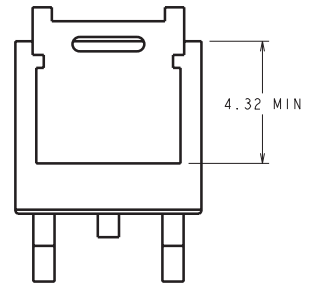
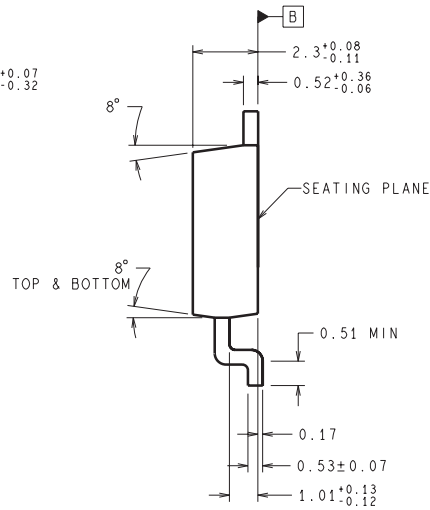
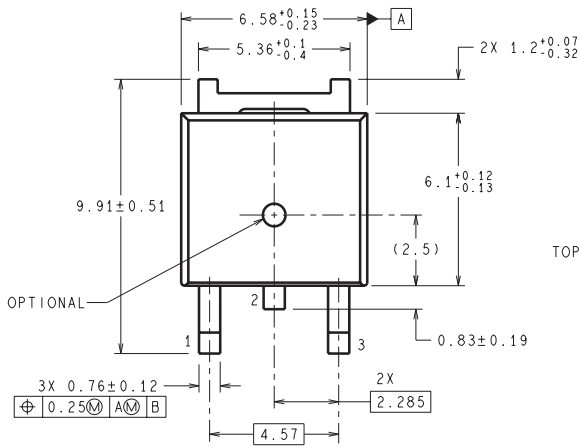

TD03B (Rev F)



DCY (R-PDSO-G4)

PLASTIC SMALL-OUTLINE



- NOTES: A. All linear dimensions are in millimeters (inches).  
 B. This drawing is subject to change without notice.  
 C. Body dimensions do not include mold flash or protrusion.  
 D. Falls within JEDEC TO-261 Variation AA.

D (R-PDSO-G8)

PLASTIC SMALL OUTLINE

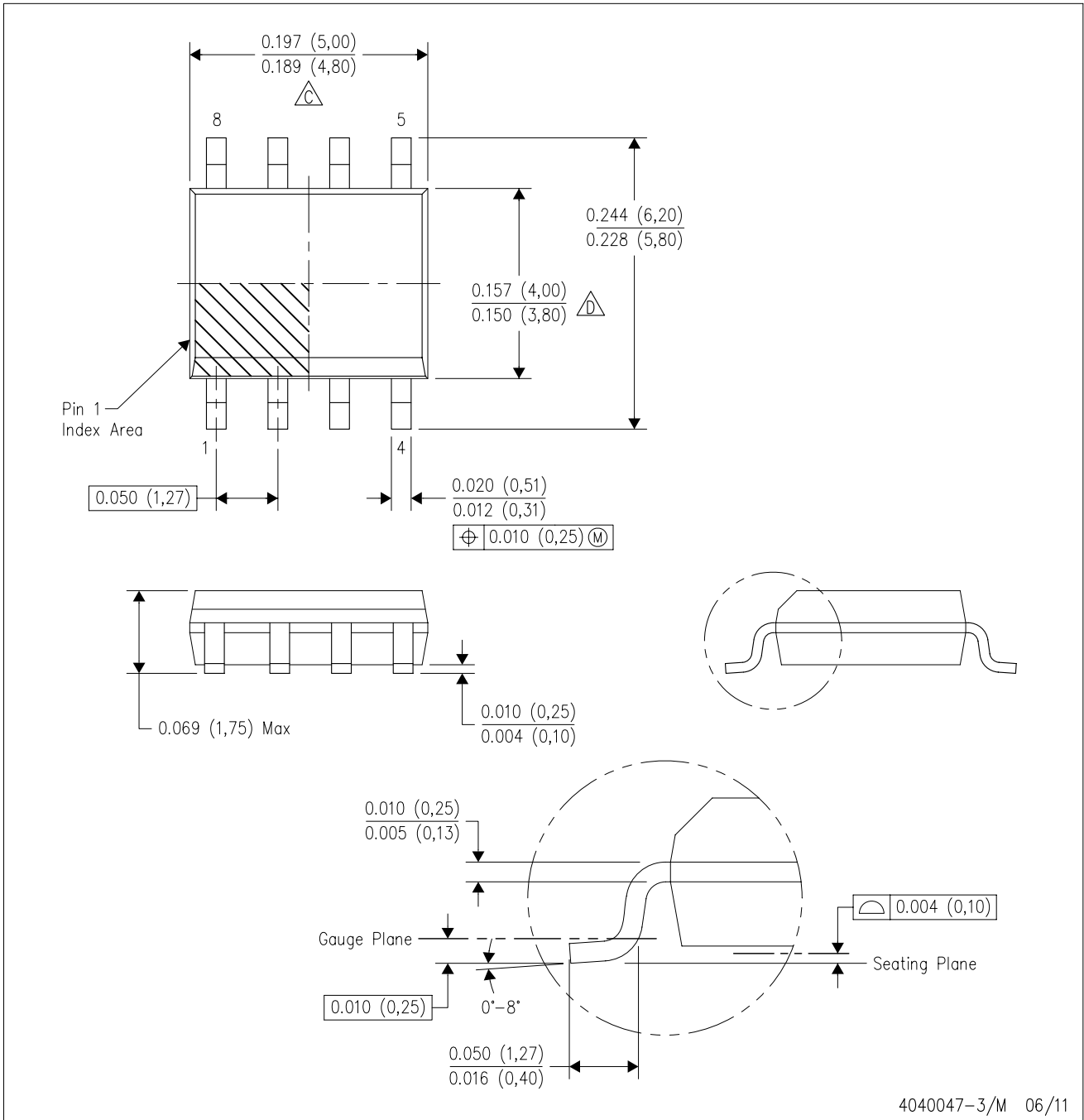

- NOTES:
- A. All linear dimensions are in inches (millimeters).
  - B. This drawing is subject to change without notice.
  - C. Body length does not include mold flash, protrusions, or gate burrs. Mold flash, protrusions, or gate burrs shall not exceed 0.006 (0,15) each side.
  - D. Body width does not include interlead flash. Interlead flash shall not exceed 0.017 (0,43) each side.
  - E. Reference JEDEC MS-012 variation AA.



**MECHANICAL DATA**

LP (O-PBCY-W3)

PLASTIC CYLINDRICAL PACKAGE

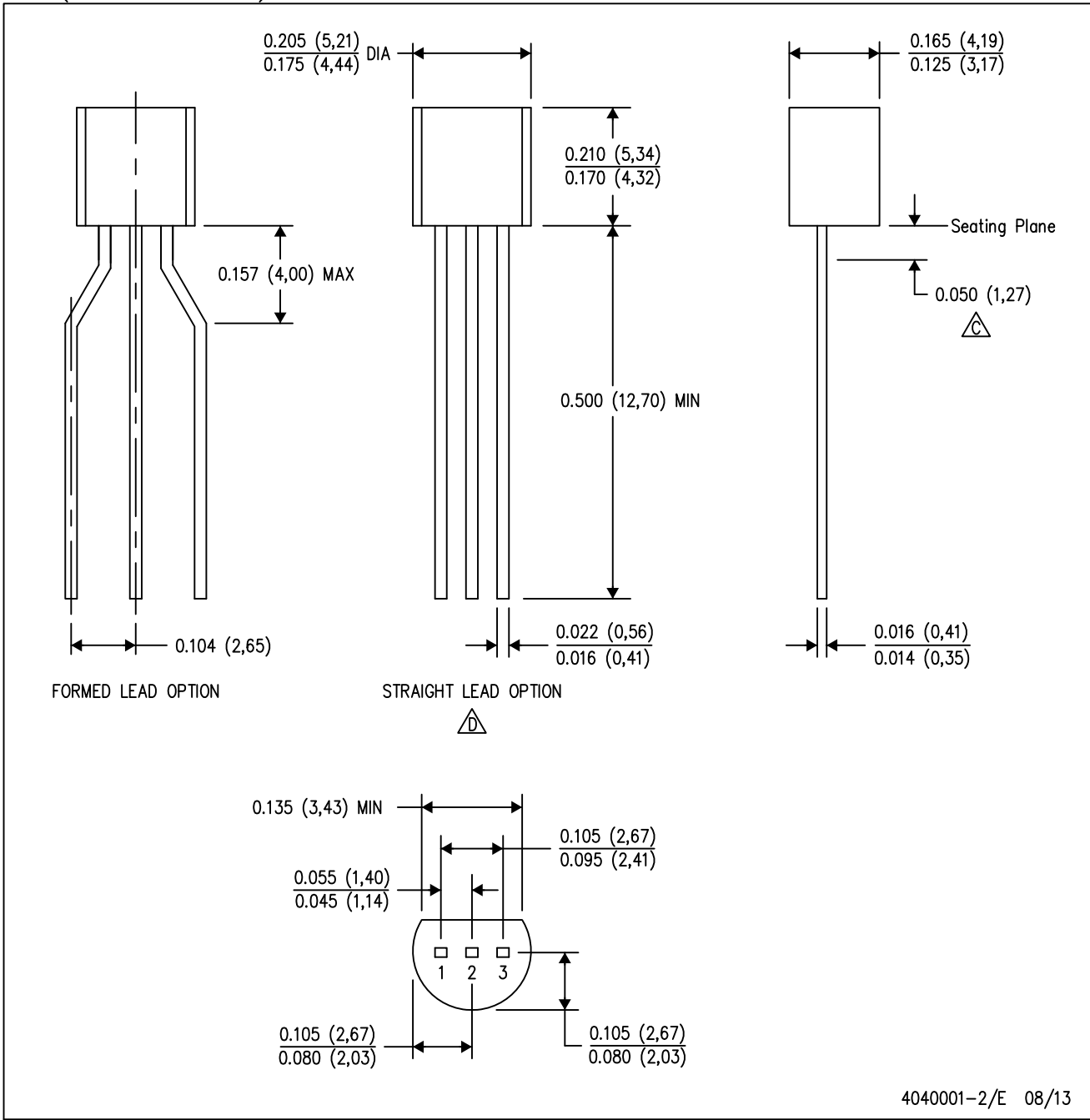

4040001-2/E 08/13

- NOTES:
- A. All linear dimensions are in inches (millimeters).
  - B. This drawing is subject to change without notice.
  - $\triangle C$  Lead dimensions are not controlled within this area.
  - $\triangle D$  Falls within JEDEC TO-226 Variation AA (TO-226 replaces TO-92).
  - E. Shipping Method:
    - Straight lead option available in bulk pack only.
    - Formed lead option available in tape & reel or ammo pack.
    - Specific products can be offered in limited combinations of shipping mediums and lead options.
    - Consult product folder for more information on available options.

**MECHANICAL DATA**

LP (O-PBCY-W3)

PLASTIC CYLINDRICAL PACKAGE

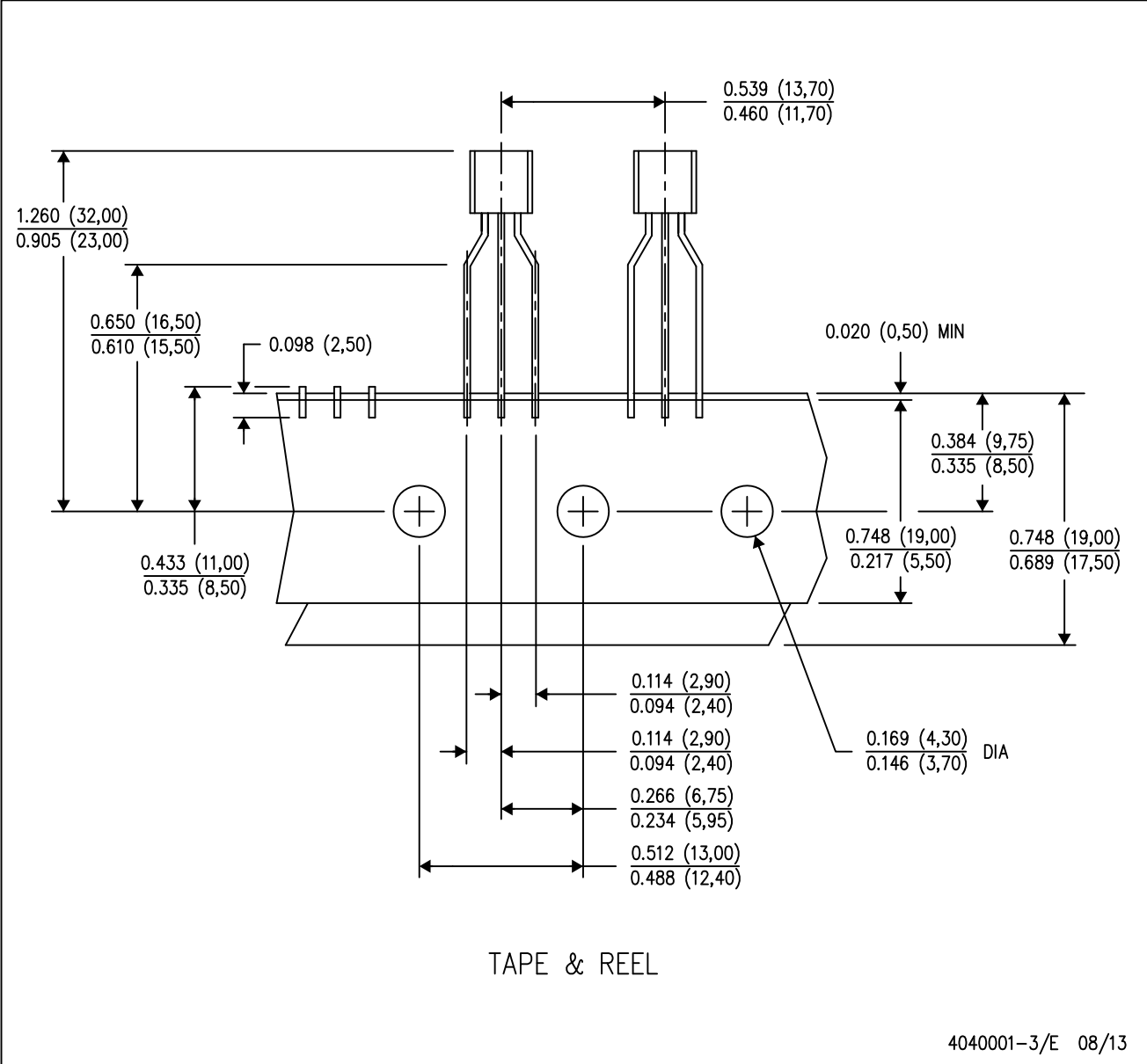

- NOTES:
- A. All linear dimensions are in inches (millimeters).
  - B. This drawing is subject to change without notice.
  - C. Tape and Reel information for the Formed Lead Option package.

## IMPORTANT NOTICE

Texas Instruments Incorporated and its subsidiaries (TI) reserve the right to make corrections, enhancements, improvements and other changes to its semiconductor products and services per JESD46, latest issue, and to discontinue any product or service per JESD48, latest issue. Buyers should obtain the latest relevant information before placing orders and should verify that such information is current and complete. All semiconductor products (also referred to herein as "components") are sold subject to TI's terms and conditions of sale supplied at the time of order acknowledgment.

TI warrants performance of its components to the specifications applicable at the time of sale, in accordance with the warranty in TI's terms and conditions of sale of semiconductor products. Testing and other quality control techniques are used to the extent TI deems necessary to support this warranty. Except where mandated by applicable law, testing of all parameters of each component is not necessarily performed.

TI assumes no liability for applications assistance or the design of Buyers' products. Buyers are responsible for their products and applications using TI components. To minimize the risks associated with Buyers' products and applications, Buyers should provide adequate design and operating safeguards.

TI does not warrant or represent that any license, either express or implied, is granted under any patent right, copyright, mask work right, or other intellectual property right relating to any combination, machine, or process in which TI components or services are used. Information published by TI regarding third-party products or services does not constitute a license to use such products or services or a warranty or endorsement thereof. Use of such information may require a license from a third party under the patents or other intellectual property of the third party, or a license from TI under the patents or other intellectual property of TI.

Reproduction of significant portions of TI information in TI data books or data sheets is permissible only if reproduction is without alteration and is accompanied by all associated warranties, conditions, limitations, and notices. TI is not responsible or liable for such altered documentation. Information of third parties may be subject to additional restrictions.

Resale of TI components or services with statements different from or beyond the parameters stated by TI for that component or service voids all express and any implied warranties for the associated TI component or service and is an unfair and deceptive business practice. TI is not responsible or liable for any such statements.

Buyer acknowledges and agrees that it is solely responsible for compliance with all legal, regulatory and safety-related requirements concerning its products, and any use of TI components in its applications, notwithstanding any applications-related information or support that may be provided by TI. Buyer represents and agrees that it has all the necessary expertise to create and implement safeguards which anticipate dangerous consequences of failures, monitor failures and their consequences, lessen the likelihood of failures that might cause harm and take appropriate remedial actions. Buyer will fully indemnify TI and its representatives against any damages arising out of the use of any TI components in safety-critical applications.

In some cases, TI components may be promoted specifically to facilitate safety-related applications. With such components, TI's goal is to help enable customers to design and create their own end-product solutions that meet applicable functional safety standards and requirements. Nonetheless, such components are subject to these terms.

No TI components are authorized for use in FDA Class III (or similar life-critical medical equipment) unless authorized officers of the parties have executed a special agreement specifically governing such use.

Only those TI components which TI has specifically designated as military grade or "enhanced plastic" are designed and intended for use in military/aerospace applications or environments. Buyer acknowledges and agrees that any military or aerospace use of TI components which have **not** been so designated is solely at the Buyer's risk, and that Buyer is solely responsible for compliance with all legal and regulatory requirements in connection with such use.

TI has specifically designated certain components as meeting ISO/TS16949 requirements, mainly for automotive use. In any case of use of non-designated products, TI will not be responsible for any failure to meet ISO/TS16949.

### Products

Audio	<a href="http://www.ti.com/audio">www.ti.com/audio</a>
Amplifiers	<a href="http://amplifier.ti.com">amplifier.ti.com</a>
Data Converters	<a href="http://dataconverter.ti.com">dataconverter.ti.com</a>
DLP® Products	<a href="http://www.dlp.com">www.dlp.com</a>
DSP	<a href="http://dsp.ti.com">dsp.ti.com</a>
Clocks and Timers	<a href="http://www.ti.com/clocks">www.ti.com/clocks</a>
Interface	<a href="http://interface.ti.com">interface.ti.com</a>
Logic	<a href="http://logic.ti.com">logic.ti.com</a>
Power Mgmt	<a href="http://power.ti.com">power.ti.com</a>
Microcontrollers	<a href="http://microcontroller.ti.com">microcontroller.ti.com</a>
RFID	<a href="http://www.ti-rfid.com">www.ti-rfid.com</a>
OMAP Applications Processors	<a href="http://www.ti.com/omap">www.ti.com/omap</a>
Wireless Connectivity	<a href="http://www.ti.com/wirelessconnectivity">www.ti.com/wirelessconnectivity</a>

### Applications

Automotive and Transportation	<a href="http://www.ti.com/automotive">www.ti.com/automotive</a>
Communications and Telecom	<a href="http://www.ti.com/communications">www.ti.com/communications</a>
Computers and Peripherals	<a href="http://www.ti.com/computers">www.ti.com/computers</a>
Consumer Electronics	<a href="http://www.ti.com/consumer-apps">www.ti.com/consumer-apps</a>
Energy and Lighting	<a href="http://www.ti.com/energy">www.ti.com/energy</a>
Industrial	<a href="http://www.ti.com/industrial">www.ti.com/industrial</a>
Medical	<a href="http://www.ti.com/medical">www.ti.com/medical</a>
Security	<a href="http://www.ti.com/security">www.ti.com/security</a>
Space, Avionics and Defense	<a href="http://www.ti.com/space-avionics-defense">www.ti.com/space-avionics-defense</a>
Video and Imaging	<a href="http://www.ti.com/video">www.ti.com/video</a>

### TI E2E Community

[e2e.ti.com](http://e2e.ti.com)