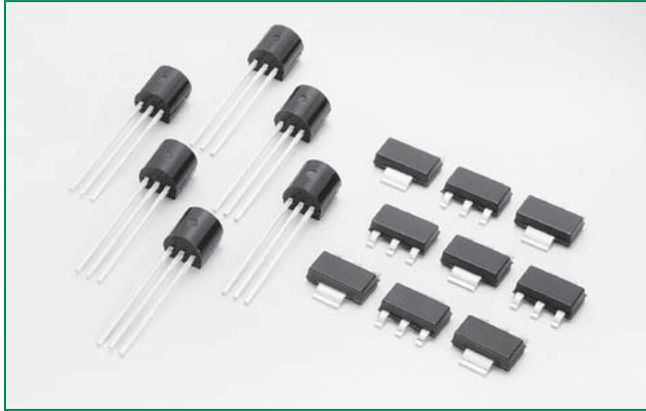


**Sx02xS Series**



**Description**

New 1.5 Amp sensitive gate SCR series offers high static dv/dt with low turn off time (tq) through small die planar construction design. All SCR's junctions are glass-passivated to ensure long term reliability and parametric stability.

**Features**

- RoHS compliant and Halogen-Free
- Thru hole and surface mount packages
- Surge capability > 15Amps
- Blocking voltage ( $V_{DRM}/V_{RRM}$ ) capability — up to 600V
- High dv/dt noise immunity
- Improved turn-off time (tq) < 35 µsec.
- Sensitive gate for direct microprocessor interface

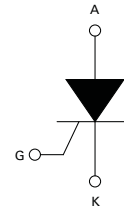
**Main Features**

Symbol	Value	Unit
$I_{T(RMS)}$	1.5	A
$V_{DRM}/V_{RRM}$	400 to 600	V
$I_{GT}$	200	µA

**Applications**

The Sx02xS EV series is specifically designed for Gas Ignition applications that require high pulse surge current capability.

**Schematic Symbol**



**Absolute Maximum Ratings**

Symbol	Parameter	Value	Unit	
$I_{T(RMS)}$	RMS on-state current (full sine wave)	TO-92 $T_c = 65^\circ\text{C}$	1.5	A
		SOT-223 $T_L = 95^\circ\text{C}$		
$I_{T(AV)}$	Average on-state current	TO-92 $T_c = 65^\circ\text{C}$	0.95	A
		SOT-223 $T_c = 95^\circ\text{C}$		
$I_{TSM}$	Non repetitive surge peak on-state current (Single cycle, $T_J$ initial = $25^\circ\text{C}$ )	TO-92 $F = 50$ Hz	12.5	A
		SOT-223 $F = 60$ Hz	15.0	
$I^2t$	$I^2t$ Value for fusing	$t_p = 10$ ms $F = 50$ Hz	0.78	A <sup>2</sup> s
		$t_p = 8.3$ ms $F = 60$ Hz	0.93	
di/dt	Critical rate of rise of on-state current $I_G = 10\text{mA}$	TO-92 $T_J = 125^\circ\text{C}$ SOT-223	50	A/µs
$I_{GM}$	Peak gate current	$t_p = 10$ µs $T_J = 125^\circ\text{C}$	1.0	A
$P_{G(AV)}$	Average gate power dissipation	$T_J = 125^\circ\text{C}$	0.1	W
$T_{stg}$	Storage junction temperature range		-40 to 150	°C
$T_J$	Operating junction temperature range		-40 to 125	°C

**Electrical Characteristics (T<sub>J</sub> = 25°C, unless otherwise specified)**

Symbol	Description	Test Conditions	Sx02xS		Unit
			Min	Max	
I <sub>GT</sub>	DC Gate Trigger Current	V <sub>D</sub> = 12V R <sub>L</sub> = 60 Ω	15	200	μA
V <sub>GT</sub>	DC Gate Trigger Voltage		—	0.8	V
V <sub>GRM</sub>	Peak Reverse Gate Voltage	I <sub>RG</sub> = 10μA	5	—	V
I <sub>H</sub>	Holding Current	R <sub>GK</sub> = 1 kΩ	—	5	mA
(dv/dt) <sub>s</sub>	Critical Rate-of-Rise of Off-State Voltage	T <sub>J</sub> = 125°C V <sub>D</sub> = V <sub>DRM</sub> / V <sub>RRM</sub> Exponential Waveform R <sub>GK</sub> = 1 kΩ	25	—	V/μs
t <sub>q</sub>	Turn-Off Time	T <sub>J</sub> = 125°C @ 600 V R <sub>GK</sub> = 1 kΩ	—	35	μs
t <sub>gt</sub>	Turn-On Time	I <sub>G</sub> = 10mA PW = 15μsec I <sub>T</sub> = 3.0A (pk)	—	3	μs

**Static Characteristics (T<sub>J</sub> = 25°C, unless otherwise specified)**

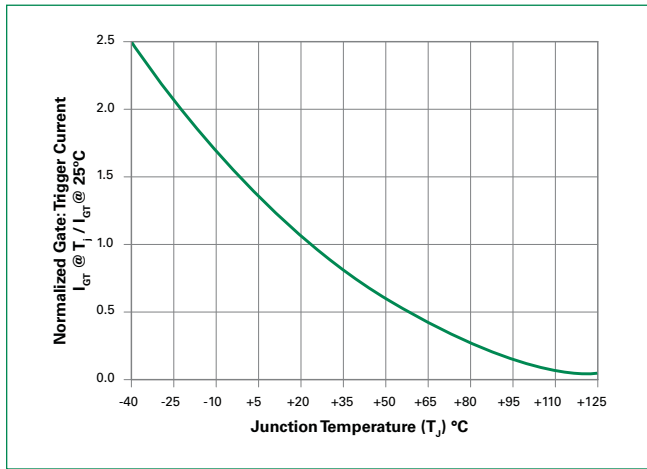
Symbol	Description	Test Conditions	Value		Unit
			Min	Max	
V <sub>TM</sub>	Peak On-State Voltage	I <sub>TM</sub> = 3.0A (pk)	—	1.70	V
I <sub>DRM</sub>	Off-State Current, Peak Repetitive	T <sub>J</sub> = 25°C @ V <sub>D</sub> = V <sub>DRM</sub> R <sub>GK</sub> = 1 kΩ	—	5	μA
		T <sub>J</sub> = 125°C @ V <sub>D</sub> = V <sub>DRM</sub> R <sub>GK</sub> = 1 kΩ	—	500	μA

**Thermal Resistances**

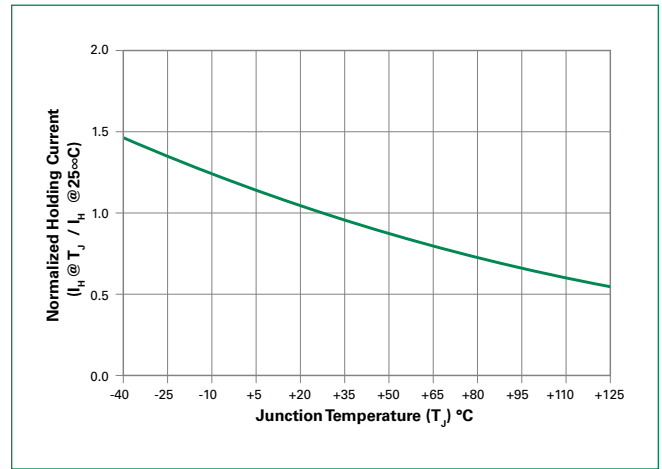
Symbol	Description	Test Conditions	Value	Unit	
R <sub>th(j-c)</sub>	Junction to case (AC)	I <sub>T</sub> = 1.5A <sub>(RMS)</sub> <sup>1</sup>	TO-92	50	°C/W
			SOT-223	25	
R <sub>th(j-a)</sub>	Junction to ambient	I <sub>T</sub> = 1.5A <sub>(RMS)</sub> <sup>1</sup>	TO-92	160	°C/W
			SOT-223	60	

<sup>1</sup> 60Hz AC resistive load condition, 100% conduction.

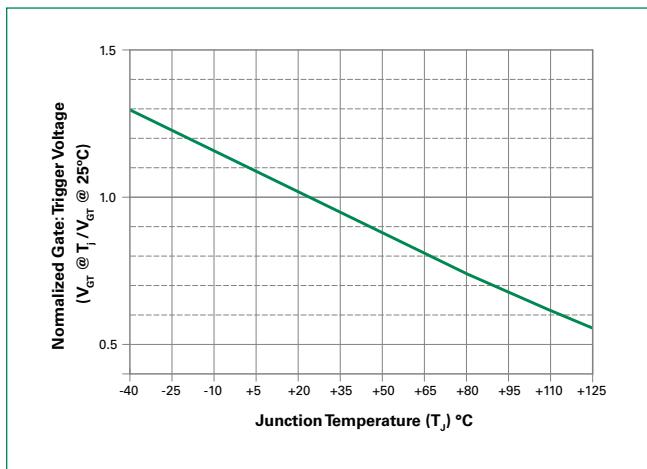
**Figure 1: Normalized DC Gate Trigger Current vs. Junction Temperature**



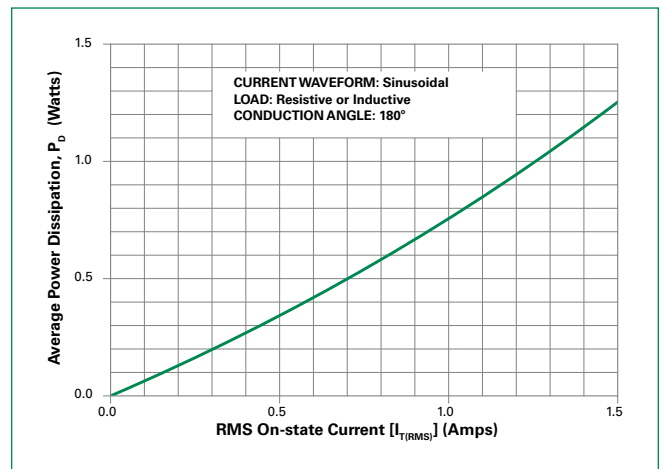
**Figure 2: Normalized DC Holding Current vs. Junction Temperature**



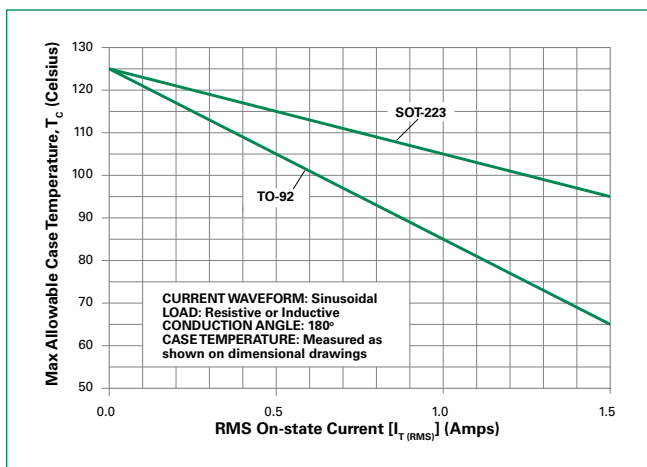
**Figure 3: Normalized DC Gate Trigger Voltage vs. Junction Temperature**



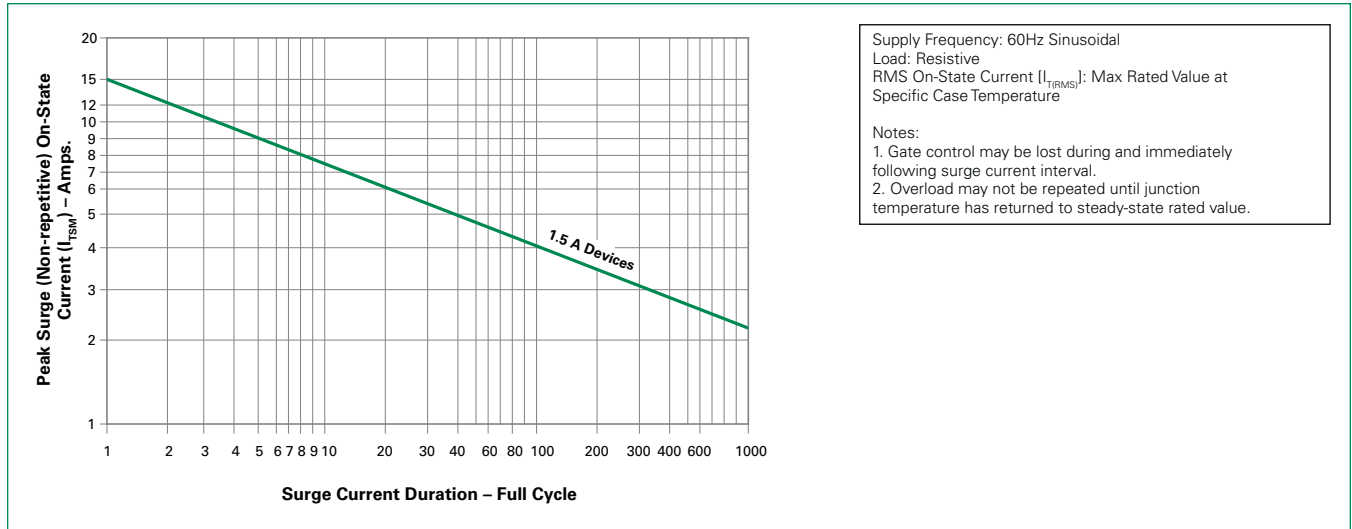
**Figure 4: Power Dissipation (Typical) vs. RMS On-State Current**



**Figure 5: Maximum Allowable Case Temperature vs. On-State Current**

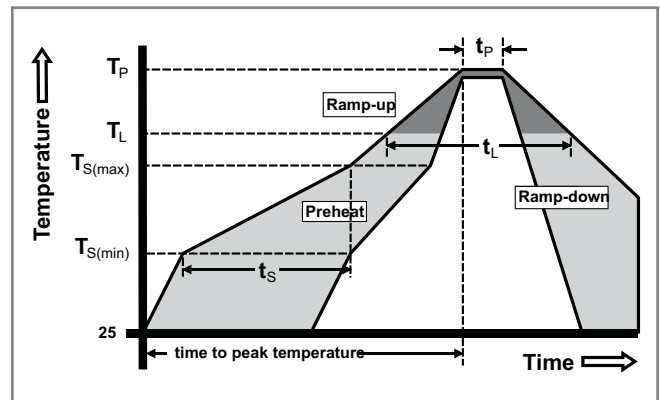


**Figure 6: Surge Peak On-State Current vs. Number of Cycles**



**Soldering Parameters**

Reflow Condition		Pb – Free assembly
Pre Heat	- Temperature Min ( $T_{s(min)}$ )	150°C
	- Temperature Max ( $T_{s(max)}$ )	200°C
	- Time (min to max) ( $t_s$ )	60 – 180 secs
Average ramp up rate (Liquidus Temp) ( $T_L$ ) to peak		5°C/second max
$T_{s(max)}$ to $T_L$ - Ramp-up Rate		5°C/second max
Reflow	- Temperature ( $T_L$ ) (Liquidus)	217°C
	- Time (min to max) ( $t_s$ )	60 – 150 seconds
Peak Temperature ( $T_p$ )		260 <sup>+0/-5</sup> °C
Time within 5°C of actual peak Temperature ( $t_p$ )		20 – 40 seconds
Ramp-down Rate		5°C/second max
Time 25°C to peak Temperature ( $T_p$ )		8 minutes Max.
Do not exceed		280°C



**Physical Specifications**

<b>Terminal Finish</b>	100% Matte Tin-plated.
<b>Body Material</b>	UL recognized epoxy meeting flammability classification 94V-0.
<b>Lead Material</b>	Copper Alloy

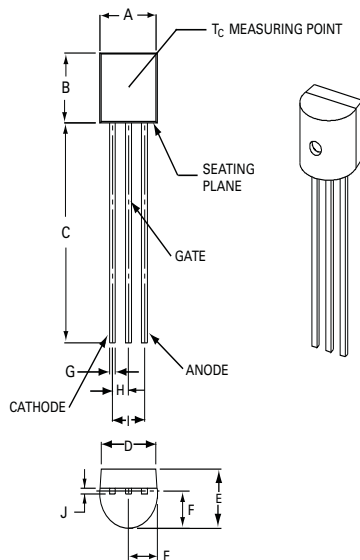
**Design Considerations**

Careful selection of the correct device for the application's operating parameters and environment will go a long way toward extending the operating life of the Thyristor. Good design practice should limit the maximum continuous current through the main terminals to 75% of the device rating. Other ways to ensure long life for a power discrete semiconductor are proper heat sinking and selection of voltage ratings for worst case conditions. Overheating, overvoltage (including dv/dt), and surge currents are the main killers of semiconductors. Correct mounting, soldering, and forming of the leads also help protect against component damage.

**Environmental Specifications**

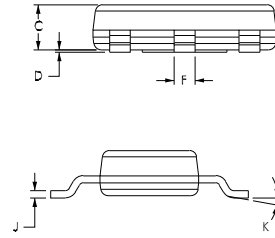
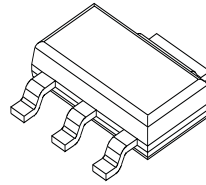
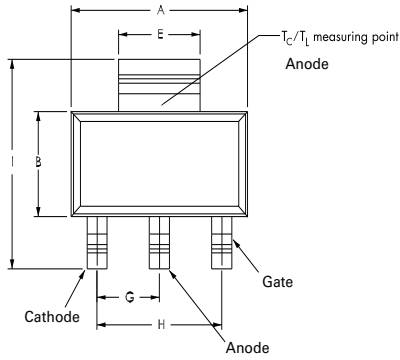
Test	Specifications and Conditions
<b>AC Blocking</b>	MIL-STD-750, M-1040, Cond A Applied Peak AC voltage @ 125°C for 1008 hours
<b>Temperature Cycling</b>	MIL-STD-750, M-1051, 100 cycles; -40°C to +150°C; 15-min dwell-time
<b>Temperature/Humidity</b>	EIA / JEDEC, JESD22-A101 1008 hours; 320V - DC: 85°C; 85% rel humidity
<b>High Temp Storage</b>	MIL-STD-750, M-1031, 1008 hours; 150°C
<b>Low-Temp Storage</b>	1008 hours; -40°C
<b>Thermal Shock</b>	MIL-STD-750, M-1056 10 cycles; 0°C to 100°C; 5-min dwell-time at each temperature; 10 sec (max) transfer time between temperature
<b>Autoclave</b>	EIA / JEDEC, JESD22-A102 168 hours (121°C at 2 ATMs) and 100% R/H
<b>Resistance to Solder Heat</b>	MIL-STD-750 Method 2031
<b>Solderability</b>	ANSI/J-STD-002, category 3, Test A
<b>Lead Bend</b>	MIL-STD-750, M-2036 Cond E

**Dimensions – TO-92 (E Package)**

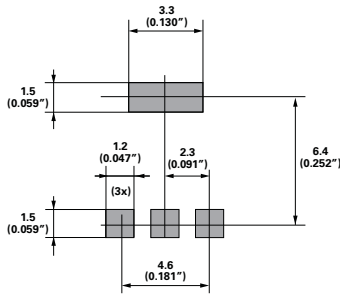


Dimensions	Inches		Millimeters	
	Min	Max	Min	Max
A	0.175	0.205	4.450	5.200
B	0.170	0.210	4.320	5.330
C	0.500	—	12.700	—
D	0.135	—	3.430	—
E	0.125	0.165	3.180	4.190
F	0.080	0.105	2.040	2.660
G	0.016	0.021	0.407	0.533
H	0.045	0.055	1.150	1.390
I	0.095	0.105	2.420	2.660
J	0.015	0.020	0.380	0.500

**Dimensions – SOT-223**



**Pad Layout for SOT-223**



Dimensions in Millimeters (Inches)

Dimensions	Inches			Millimeters		
	Min	Typ	Max	Min	Typ	Max
A	0.248	0.256	0.264	6.30	6.50	6.70
B	0.130	0.138	0.146	3.30	3.50	3.70
C	—	—	0.071	—	—	1.80
D	0.001	—	0.004	0.02	—	0.10
E	0.114	0.118	0.124	2.90	3.00	3.15
F	0.024	0.027	0.034	0.60	0.70	0.85
G	—	0.090	—	—	2.30	—
H	—	0.181	—	—	4.60	—
I	0.264	0.276	0.287	6.70	7.00	7.30
J	0.009	0.010	0.014	0.24	0.26	0.35
K	10° MAX					

**Product Selector**

Part Number	Voltage		Gate Sensitivity	Package
	400V	600V		
S402ES	X	—	200µA	TO-92
S602ES	—	X	200µA	TO-92
S402TS	X	—	200µA	SOT-223
S602TS	—	X	200µA	SOT-223

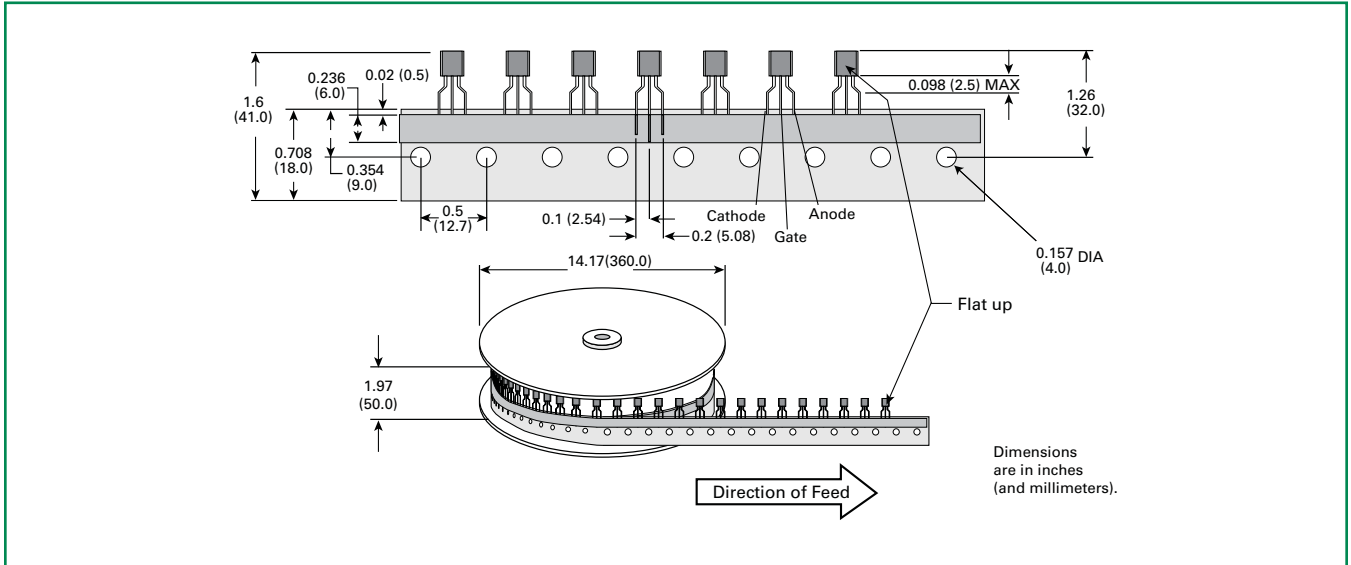
**Packing Options**

Part Number	Marking	Weight	Packing Mode	Base Quantity
Sx02ES	Sx02ES	0.170 g	Bulk	2500
Sx02ESAP	Sx02ES	0.170 g	Ammo Pack	2000
Sx02ESRP	Sx02ES	0.170 g	Tape & Reel	2000
Sx02TSRP	Sx02TS	0.120 g	Tape & Reel	1000

Note: x = voltage

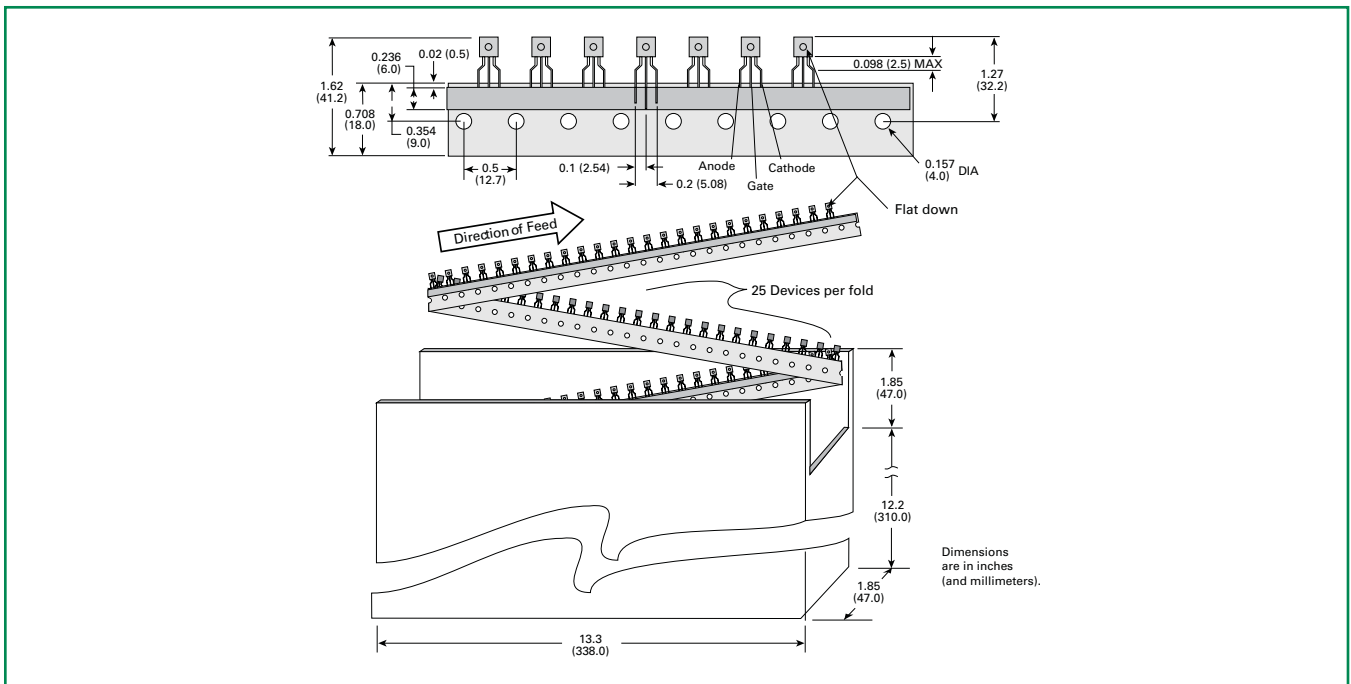
**TO-92 (3-lead) Reel Pack (RP) Radial Leaded Specifications**

Meets all EIA-468-C Standards

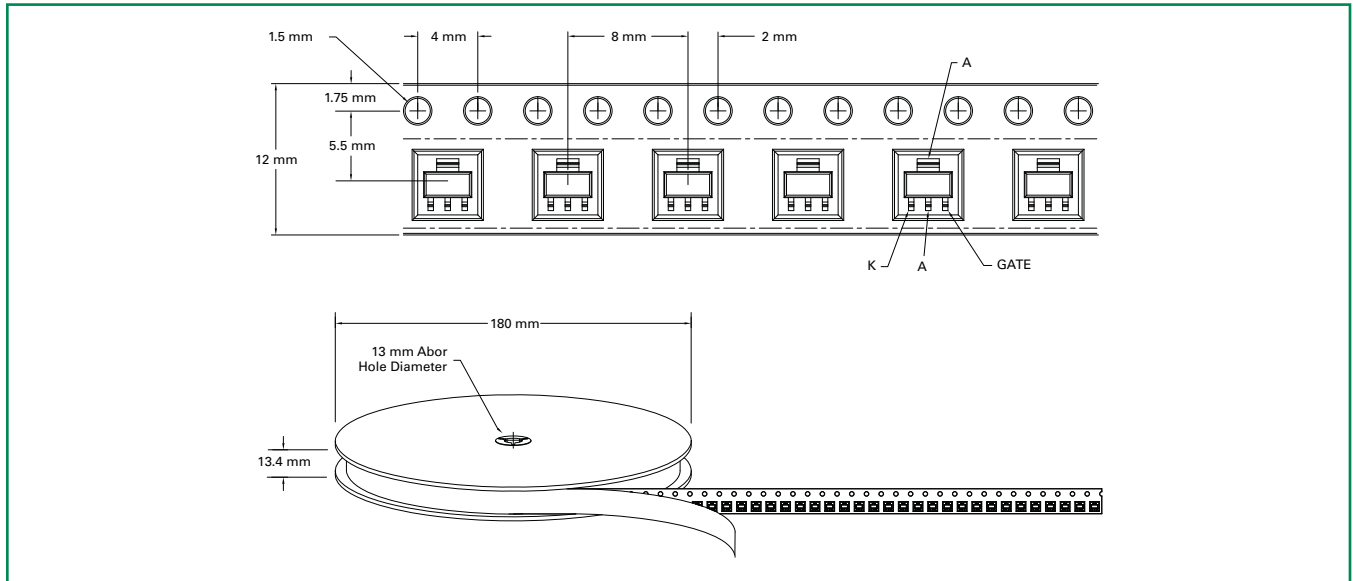


**TO-92 (3-lead) Ammo Pack (AP) Radial Leaded Specifications**

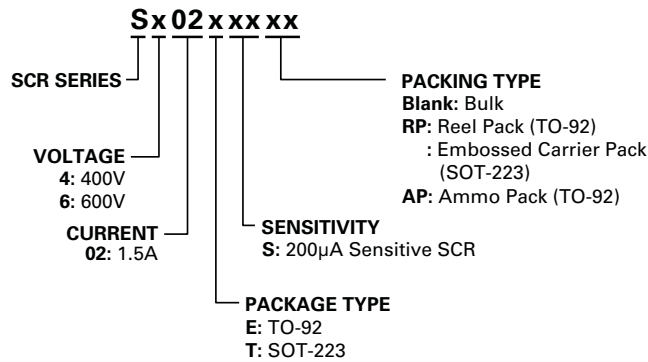
Meets all EIA-468-C Standards



**SOT-223 Reel Pack (RP) Specifications**



**Part Numbering System**



**Part Marking System**

