

SP05 Series - 30pF 30kV Unidirectional TVS Array

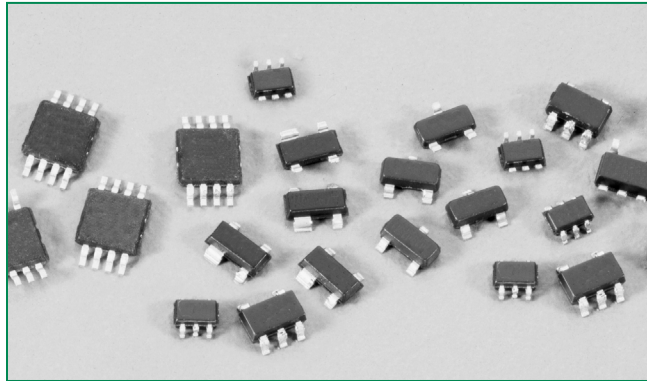

Pinout

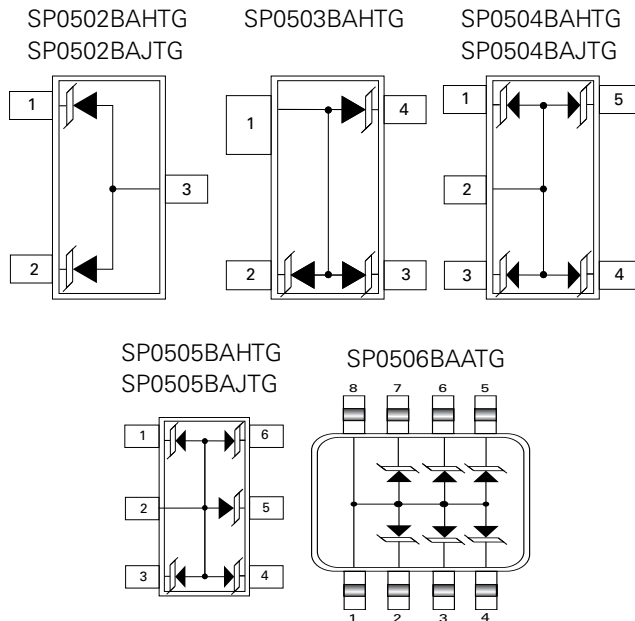

Description

This surface mount family of arrays suppresses ESD and other transient overvoltage events. Used to meet the International Electrotechnical Compatibility (IEC transient immunity standards IEC 61000-4-2 for Electrostatic Discharge Requirements), these devices can help protect sensitive digital or analog input circuits on data, signal, or control lines with voltage levels up to 5VDC.

The monolithic silicon arrays are comprised of specially designed structures for transient voltage suppression (TVS). The size and shape of these structures have been tailored for transient protection. The low capacitance and clamp voltage are ideal for high speed signal line protection.

Features

- An Array of 2, 3, 4, 5 or 6 TVS Avalanche Diodes in a ultra small SC70, SOT-23, SOT-143 or MSOP packages
- ESD Capability Standards
 - IEC 61000-4-2, Direct Discharge 30kV (Level 4)
 - IEC 61000-4-2, Air Discharge..... 30kV (Level 4)
 - MIL STD 883 3015.7.....30kV
- Input Protection for Applications Up to 5VDC
- Fast Response Time <1ns
- Low Input Capacitance.....30pF Typical
- Operating Temperature Range..... -40°C to 85°C

Applications

- Mobile phone handsets
- Personal Digital Assistants (PDA)
- Portable handheld equipment (Laptop, Palmtop computers)
- Computer port, keyboard (USB1.1)
- Digital still cameras
- Digital video cameras
- MP3 players

Additional Information



Datasheet



Resources



Samples

Life Support Note:

Not Intended for Use in Life Support or Life Saving Applications

The products shown herein are not designed for use in life sustaining or life saving applications unless otherwise expressly indicated.

Absolute Maximum Ratings

Parameter	Rating	Units
Storage Temperature Range	-40 to 125	°C
Package Power Dissipation		
SC70	0.2	W
SOT23-3, SOT23-5, SOT23-6, SOT143	0.225	W
MSOP	0.5	W

Electrical Characteristics $T_A = +25^\circ\text{C}$, Unless Otherwise Specified

Parameter	Test Conditions	Min	Typ	Max	Units
Reverse Standoff Voltage	$I_R \leq 1\mu\text{A}$	-	-	5.5	V
Reverse Standoff Leakage Current	$V = 5.0\text{V}$		1	100	nA
Signal Clamp Voltage					
Positive	$I = 1\text{mA}$	6.0		8.5	V
Negative	$I = 10\text{mA}$	-1.2	-0.8	-0.4	V
Clamp Voltage during ESD					
MIL-STD-883 Method 3015 (HBM) test					
+ 8kV			12		V
- 8kV			-8		V
ESD Test Level (1)					
IEC-61000-4-2, Contact discharge		30			kV
MIL-STD-883 Method 3015 (HBM)		30			kV
Capacitance	$2.5\text{V} @ 1\text{MHz}$		30		pF
Turn on/off Time			<1		ns
Temperature Range					
Operating		-40		85	°C
Storage		-65		150	°C
Diode Dynamic Resistance					
Forward Conduction			1.0		Ω
Reverse Conduction			1.4		Ω

Note:

(1) ESD voltage applied between channel pins and ground, one pin at a time; all other channel pins are open; all ground pins are grounded.

Typical Diode Capacitance vs. Reverse Voltage

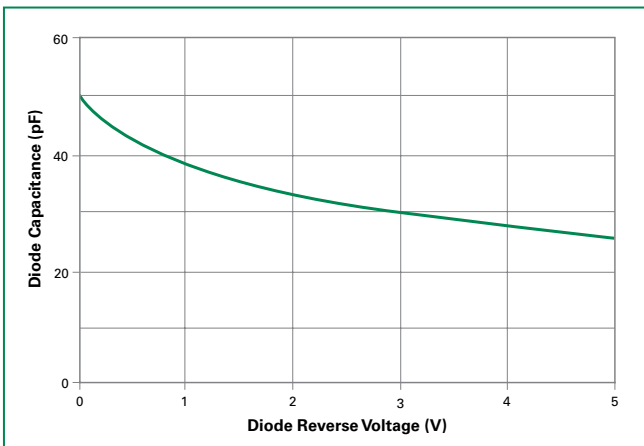

Soldering Parameters

Reflow Condition		Pb – Free assembly
Pre Heat	- Temperature Min ($T_{s(min)}$)	150°C
	- Temperature Max ($T_{s(max)}$)	200°C
	- Time (min to max) (t_s)	60 – 180 secs
Average ramp up rate (Liquidus) Temp (T_L) to peak		5°C/second max
$T_{s(max)}$ to T_L - Ramp-up Rate		5°C/second max
Reflow	- Temperature (T_L) (Liquidus)	217°C
	- Temperature (t_L)	60 – 150 seconds
Peak Temperature (T_P)		260 ^{+0/-5} °C
Time within 5°C of actual peak Temperature (t_p)		20 – 40 seconds
Ramp-down Rate		5°C/second max
Time 25°C to peak Temperature (T_P)		8 minutes Max.
Do not exceed		260°C

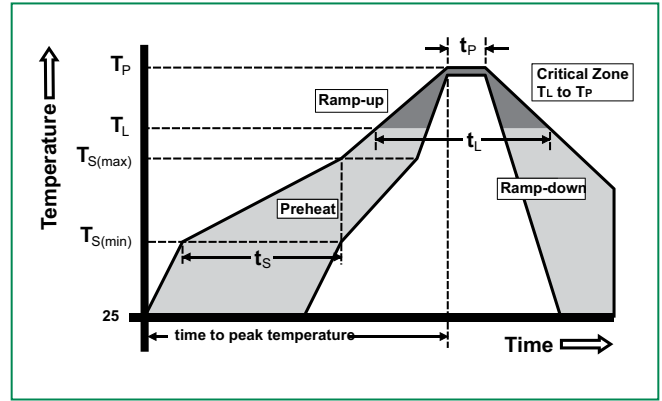

Package Dimensions – SOT143

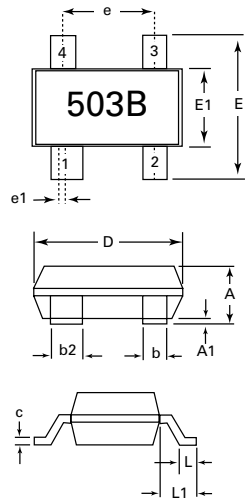

SP0503BAHTG - SOT143-4

Recommended Pad Layout

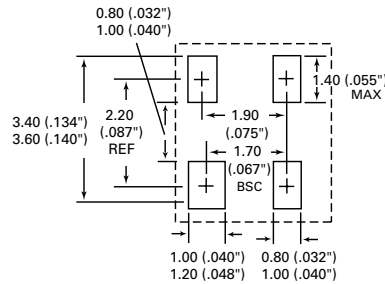

Package	SOT143-4			
Pins	4			
JEDEC	TO-253			
	Millimeters		Inches	
	Min	Max	Min	Max
A	0.8	1.22	0.03	0.048
A1	0.05	0.15	0.002	0.006
b	0.30	0.50	0.012	0.020
b2	0.76	0.89	0.030	0.035
c	0.08	0.20	0.003	0.008
D	2.80	3.04	0.110	0.120
E	2.10	2.64	0.082	0.104
E1	1.20	1.40	0.047	0.055
e	1.92 BSC		0.076 BSC	
e1	0.20 BSC		0.008 BSC	
L	0.4	0.6	0.016	0.024
L1	0.550 REF		0.022 REF	

Package Dimensions — SC70

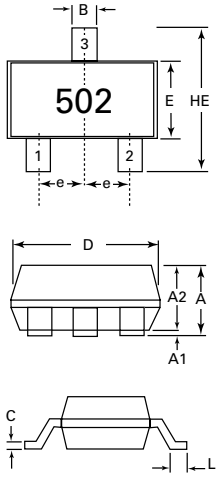

SP0502BAJTG - SC70-3

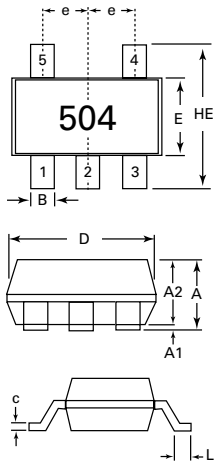

SP0504BAJTG - SC70-5

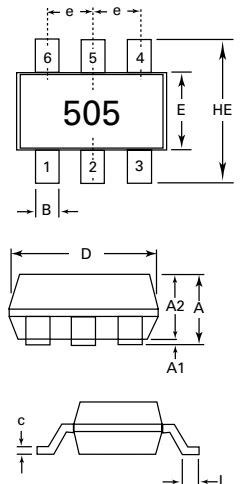

SP0505BAJTG - SC70-6

Recommended Pad Layout

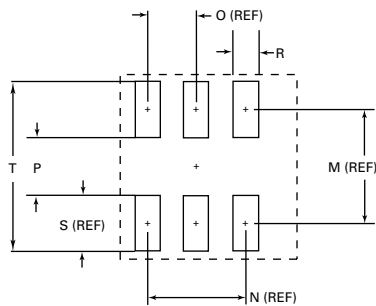

Package	SC70-3			
Pins	3			
JEDEC	MO-203			
	Millimeters		Inches	
	Min	Max	Min	Max
A	0.80	1.10	0.031	0.043
A1	0.00	0.10	0.00	0.004
A2	0.70	1.00	0.028	0.039
B	0.15	0.30	0.006	0.012
c	0.08	0.25	0.003	0.010
D	1.85	2.25	0.073	0.089
E	1.15	1.35	0.045	0.053
e	0.66 BSC		0.026 BSC	
HE	2.00	2.40	0.079	0.094
L	0.26	0.46	0.010	0.018

Package	SC70-5			
Pins	5			
JEDEC	MO-203			
	Millimeters		Inches	
	Min	Max	Min	Max
A	0.80	1.10	0.031	0.043
A1	0.00	0.10	0.00	0.004
A2	0.70	1.00	0.028	0.039
B	0.15	0.30	0.006	0.012
c	0.08	0.25	0.003	0.010
D	1.85	2.25	0.073	0.089
E	1.15	1.35	0.045	0.053
e	0.65 BSC		0.026 BSC	
HE	2.00	2.40	0.079	0.094
L	0.26	0.46	0.010	0.018

Package	SC70-6			
Pins	6			
JEDEC	MO-203			
	Millimeters		Inches	
	Min	Max	Min	Max
A	0.80	1.10	0.031	0.043
A1	0.00	0.10	0.00	0.004
A2	0.70	1.00	0.028	0.039
B	0.15	0.30	0.006	0.012
c	0.08	0.25	0.003	0.010
D	1.85	2.25	0.073	0.089
E	1.15	1.35	0.045	0.053
e	0.65 BSC		0.026 BSC	
HE	2.00	2.40	0.079	0.094
L	0.26	0.46	0.010	0.018
M	-	1.60	-	0.063
N	-	1.30	-	0.051
O	-	0.65	-	0.026
P	-	0.70	-	0.028
R	-	0.35	-	0.014
S	-	0.90	-	0.035
T	-	2.50	-	0.098

Package Dimensions – SOT23

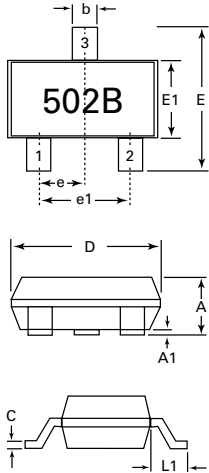

SP0502BAHTG - SOT23-3

Recommended Pad Layout

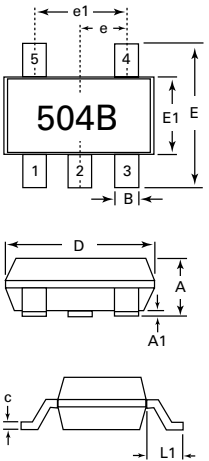
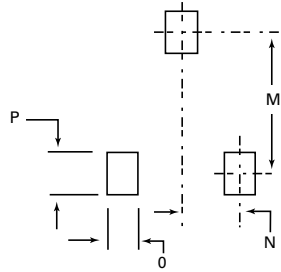

SP0504BAHTG - SOT23-5

Recommended Pad Layout

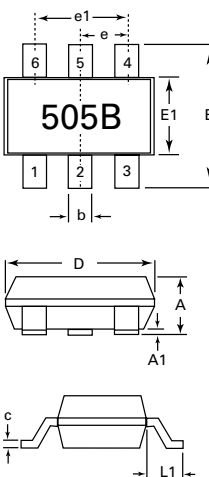
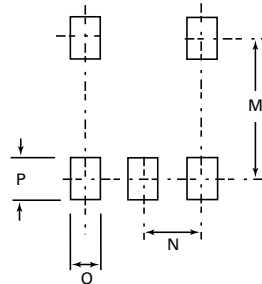

SP0505BAHTG - SOT23-6

Recommended Pad Layout

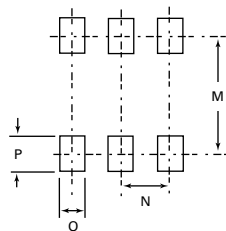

Package	SOT23-3			
Pins	3			
JEDEC	TO-236			
	Millimeters		Inches	
	Min	Max	Min	Max
A	0.89	1.12	0.035	0.044
A1	0.01	0.1	0.0004	0.004
b	0.3	0.5	0.012	0.020
c	0.08	0.2	0.003	0.008
D	2.8	3.04	0.110	0.120
E	2.1	2.64	0.083	0.104
E1	1.2	1.4	0.047	0.055
e	0.95 BSC		0.038 BSC	
e1	1.90 BSC		0.075 BSC	
L1	0.54 REF		0.021 REF	
M		2.29		.090
N		0.95		0.038
O		0.78		.030TYP
P		0.78		.030TYP

Package	SOT23-5			
Pins	5			
JEDEC	MO-178			
	Millimeters		Inches	
	Min	Max	Min	Max
A	-	1.45	-	0.057
A1	0	0.15	0	0.006
b	0.3	0.5	0.012	0.020
c	0.08	0.22	0.003	0.009
D	2.75	3.05	0.108	0.120
E	2.6	3.0	0.102	0.118
E1	1.45	1.75	0.057	0.069
e	0.95 BSC		0.038 BSC	
e1	1.90 BSC		0.075 BSC	
L1	0.60 REF		0.024 REF	
M		2.59		.102
N		0.95		.038
O		0.69		.027TYP
P		0.99		.039TYP

Package	SOT23-6			
Pins	6			
JEDEC	MO-178			
	Millimeters		Inches	
	Min	Max	Min	Max
A	-	1.45	-	0.057
A1	0	0.15	0	0.006
b	0.3	0.5	0.012	0.020
c	0.08	0.22	0.003	0.009
D	2.75	3.05	0.108	0.120
E	2.6	3.0	0.102	0.118
E1	1.45	1.75	0.057	0.069
e	0.95 BSC		0.038 BSC	
e1	1.90 BSC		0.075 BSC	
L1	0.60 REF		0.024 REF	
M		2.59		.102
N		0.95		0.038
O		0.69		.027TYP
P		0.99		.039TYP

Package Dimensions – MSOP

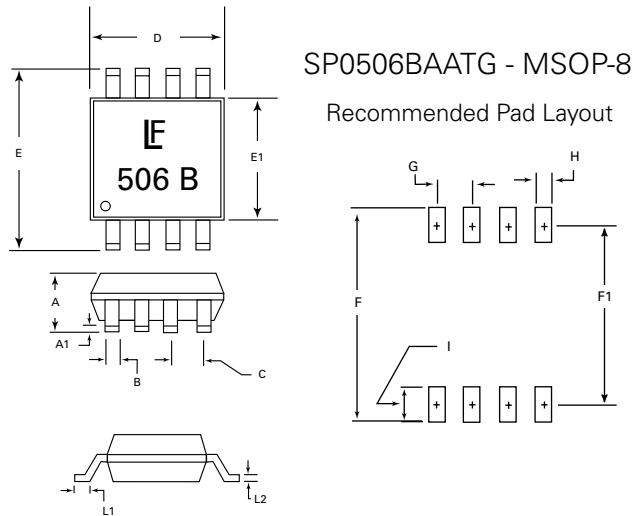

Package	MSOP			
Pins	8			
JEDEC	MO-187			
	Millimeters		Inches	
	Min	Max	Min	Max
D	2.90	3.10	0.114	.122
E	4.78	4.98	.188	.196
E1	2.90	3.10	.114	.122
A	0.87	1.17	.034	.046
A1	0.05	0.25	.002	0.010
B	-	0.30TYP	-	0.012TYP
C	-	0.65TYP	-	0.026TYP
L1	0.52	0.54	0.020	0.021
L2	-	0.18TYP	-	.007TYP
F	-	5.28	-	.208
F1	-	4.24	-	.167
G	-	0.65	-	0.026
H	-	0.38	-	.015
I	-	1.04	-	.041

Part Numbering System

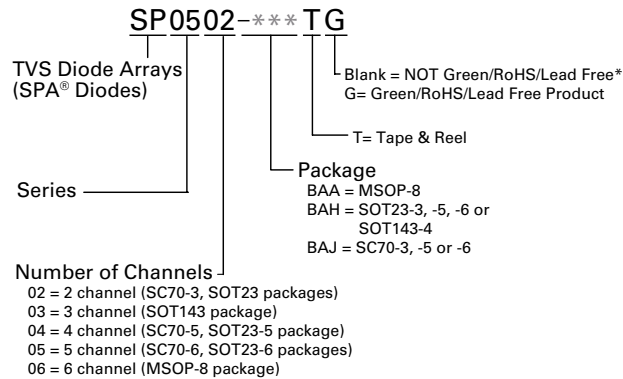

Product Characteristics

Lead Plating	"G" Green version - Matte Tin (Sn)
Lead Material	Copper / Iron Alloy
Lead Coplanarity	0.004 inches (0.102mm)
Substitute Material	Silicon
Body Material	Molded Epoxy
Flammability	UL 94 V-0

Notes:

- All dimensions are in millimeters.
- Dimensions include solder plating.
- Dimensions are exclusive of mold flash & metal burr.
- Blo is facing up for mold and facing down for trim/form, i.e. reverse trim/form.
- Package surface matte finish VDI 11-13.

Ordering Information

*NOTE: To order NON-Green/RoHS/Lead Free version of product, remove "G" at the end of part number.

Part Number	CH	Package Type	Quantity Per Reel
SP0502BAHTG	2	SOT23-3	3000
SP0503BAHTG	3	SOT143-4	3000
SP0504BAHTG	4	SOT23-5	3000
SP0505BAHTG	5	SOT23-6	3000
SP0506BAATG	6	MSOP-8	4000
SP0502BAJTG	2	SC70-3	3000
SP0504BAJTG	4	SC70-5	3000
SP0505BAJTG	5	SC70-6	3000

Embossed Carrier Tape & Reel Specification – SOT23-3

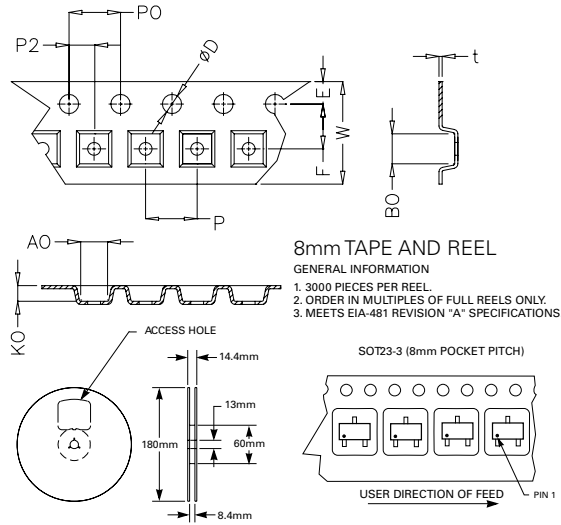

Symbol	Millimetres		Inches	
	Min	Max	Min	Max
E	1.65	1.85	0.065	0.073
F	3.40	3.60	0.134	0.142
P2	1.90	2.10	0.075	0.083
D	1.40	1.60	0.055	0.063
P0	3.90	4.10	0.154	0.161
W	7.70	8.30	0.303	0.327
P	3.90	4.10	0.154	0.161
A0	3.05	3.25	0.120	0.128
B0	2.67	2.87	0.105	0.113
K0	1.12	1.32	0.044	0.052
t	0.22	0.24	0.009	0.009

Embossed Carrier Tape & Reel Specification – SOT23-5

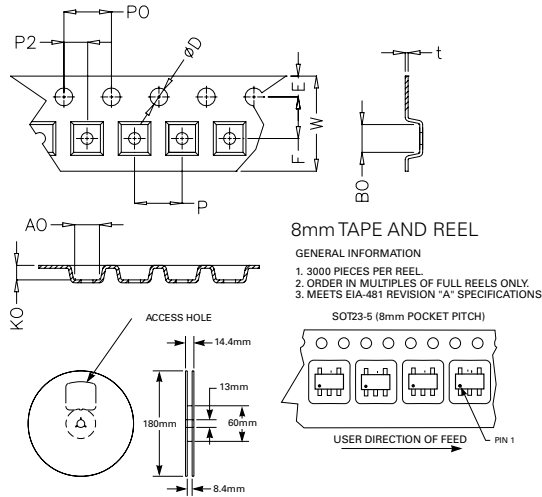

Symbol	Millimetres		Inches	
	Min	Max	Min	Max
E	1.65	1.85	0.065	0.073
F	3.40	3.60	0.134	0.142
P2	1.90	2.10	0.075	0.083
D	1.40	1.60	0.055	0.063
P0	3.90	4.10	0.154	0.161
W	7.70	8.30	0.303	0.327
P	3.90	4.10	0.154	0.161
A0	3.05	3.25	0.120	0.128
B0	2.67	2.87	0.105	0.113
K0	1.12	1.32	0.044	0.052
t	0.22	0.24	0.009	0.009

Embossed Carrier Tape & Reel Specification – SOT23-6

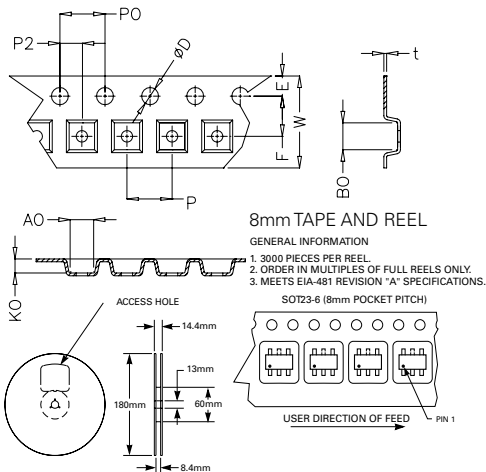

Symbol	Millimetres		Inches	
	Min	Max	Min	Max
E	1.65	1.85	0.065	0.073
F	3.40	3.60	0.134	0.142
P2	1.90	2.10	0.075	0.083
D	1.40	1.60	0.055	0.063
P0	3.90	4.10	0.154	0.161
W	7.70	8.30	0.303	0.327
P	3.90	4.10	0.154	0.161
A0	3.05	3.25	0.120	0.128
B0	2.67	2.87	0.105	0.113
K0	1.12	1.32	0.044	0.052
t	0.22	0.24	0.009	0.009

Embossed Carrier Tape & Reel Specification – SOT143-4

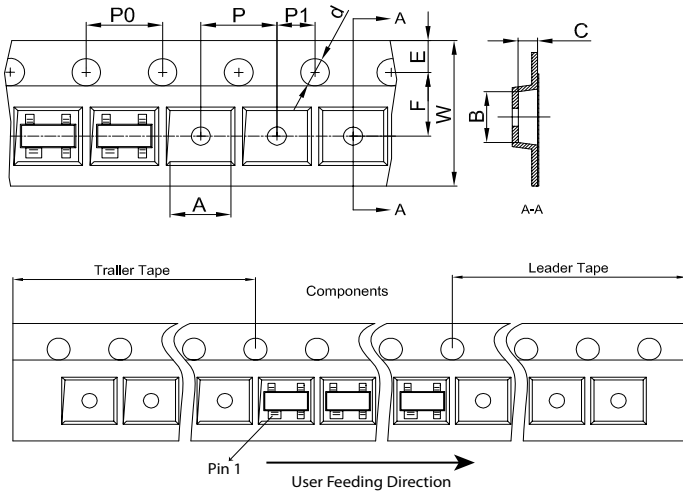

Symbol	Millimetres		Inches	
	Min	Max	Min	Max
A	3.09	3.09	0.122	0.130
B	2.70	2.90	1.106	0.114
C	1.21	1.41	0.048	0.056
d	1.40	1.60	0.055	0.102
E	1.65	0.85	0.065	0.073
F	3.45	3.65	0.133	0.142
P0	4.10	3.90	0.154	0.161
P	4.10	3.90	0.154	0.161
P1	1.90	2.10	0.075	0.083
W	7.90	8.10	0.311	0.319

Embossed Carrier Tape & Reel Specification – MSOP-8

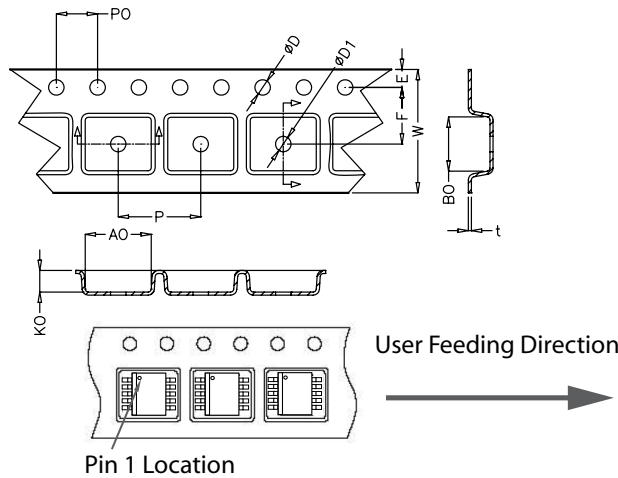

	Millimetres		Inches	
	Min	Max	Min	Max
E	1.65	1.85	0.065	0.073
F	5.40	5.60	0.213	0.220
D	1.50	1.60	0.059	0.063
D1	1.50 Min		0.059 Min	
P0	3.90	4.10	0.154	0.161
W	11.70	12.30	0.461	0.484
P	7.90	8.10	0.311	0.319
AO	5.20	5.40	0.205	0.213
B0	3.30	3.40	0.126	0.134
K0	1.20	1.40	0.047	0.055
t	0.30 ± 0.05		0.012 ± 0.002	

Embossed Carrier Tape & Reel Specification – SC70-3

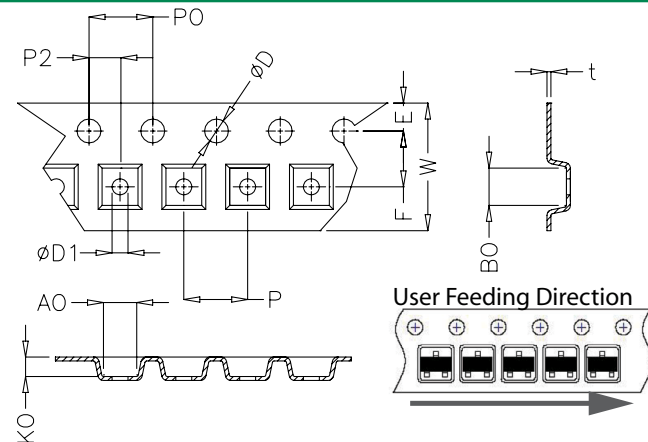

Symbol	Millimetres		Inches	
	Min	Max	Min	Max
E	1.65	1.85	0.064	0.073
F	3.45	3.55	0.135	0.139
P2	1.95	2.05	0.077	0.081
D	1.40	1.60	0.055	0.063
D1	1.00	1.25	0.039	0.049
P0	3.90	4.10	0.154	0.161
W	7.70	8.10	0.303	0.318
P	3.90	4.10	0.153	0.161
AO	2.14	2.34	0.084	0.092
B0	2.24	2.44	0.088	0.096
K0	1.12	1.32	0.044	0.052
t	0.27 Max		0.010 Max	

Embossed Carrier Tape & Reel Specification – SC70-5

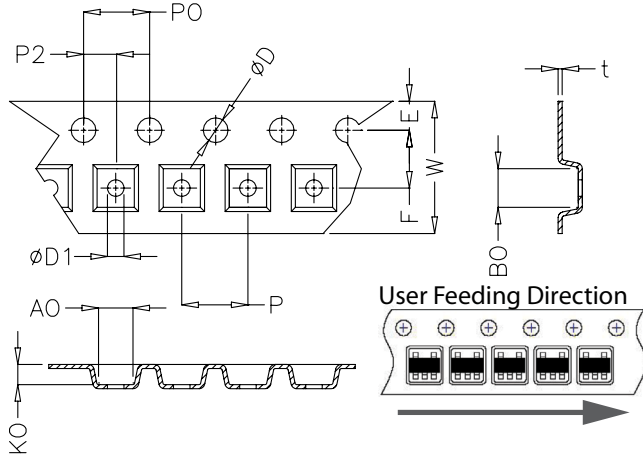

Symbol	Millimetres		Inches	
	Min	Max	Min	Max
E	1.65	1.85	0.064	0.073
F	3.45	3.55	0.135	0.139
P2	1.95	2.05	0.077	0.081
D	1.40	1.60	0.055	0.063
D1	1.00	1.25	0.039	0.049
P0	3.90	4.10	0.154	0.161
W	7.70	8.10	0.303	0.318
P	3.90	4.10	0.153	0.161
A0	2.14	2.34	0.084	0.092
B0	2.24	2.44	0.088	0.096
K0	1.12	1.32	0.044	0.052
t	0.27 Max		0.010 Max	

Embossed Carrier Tape & Reel Specification – SC70-6

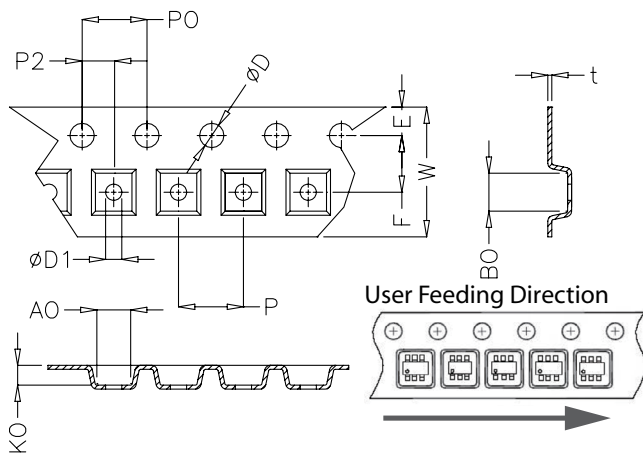

Symbol	Millimetres		Inches	
	Min	Max	Min	Max
E	1.65	1.85	0.064	0.073
F	3.45	3.55	0.135	0.139
P2	1.95	2.05	0.077	0.081
D	1.40	1.60	0.055	0.063
D1	1.00	1.25	0.039	0.049
P0	3.90	4.10	0.154	0.161
W	7.70	8.10	0.303	0.318
P	3.90	4.10	0.153	0.161
A0	2.14	2.34	0.084	0.092
B0	2.24	2.44	0.088	0.096
K0	1.12	1.32	0.044	0.052
t	0.27 Max		0.010 Max	