

Protective Devices

Add-on Residual Current Protection PBSM MW



- By combining this device with a top-quality miniature circuit breaker of type PLS. (except PLSN) a top-quality RCBO unit (combined RCD/MCB device) is formed.
- Draw-out connection bar locked in installation position
- For subsequent mounting onto 2-, 3-, 3+N- and 4-pole miniature circuit breakers PLS.
- Rated current 40 and 63 A

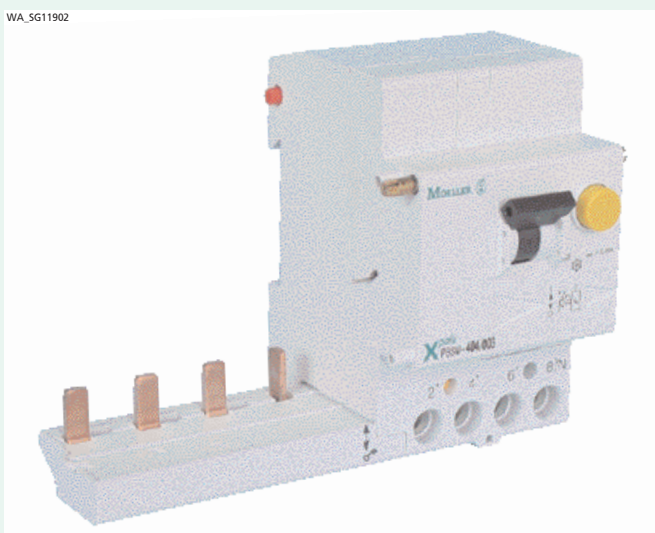

Xpole

WA_5G11902

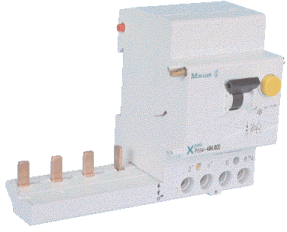

Protective Devices

		Add-on Residual Current Protection Unit PBSM		MW	
		conditionally surge-current-proof 250 A, type AC			
		Max. nominal current of PLS./I _{Δn} (A)	Type designation	Article-No.	Units per package
 <p>WA_SG11702</p>	2-pole				
	40/0,03	PBSM-402/003	262323	1 / 20	
	40/0,10	PBSM-402/01	262324	1 / 20	
	40/0,30	PBSM-402/03	262325	1 / 20	
	40/0,50	PBSM-402/05	262326	1 / 20	
	40/1,00	PBSM-402/1	262327	1 / 20	
	63/0,03	PBSM-632/003	262426	1 / 20	
	63/0,10	PBSM-632/01	262427	1 / 20	
	63/0,30	PBSM-632/03	262428	1 / 20	
	63/0,5	PBSM-632/05	262429	1 / 20	
63/1,00	PBSM-632/1	262431	1 / 20		
 <p>WA_SG11802</p>	3-pole				
	40/0,03	PBSM-403/003	262537	1 / 20	
	40/0,10	PBSM-403/01	262538	1 / 20	
	40/0,30	PBSM-403/03	262539	1 / 20	
	40/0,50	PBSM-403/05	262541	1 / 20	
	40/1,00	PBSM-403/1	262542	1 / 20	
	63/0,03	PBSM-633/003	262556	1 / 20	
	63/0,10	PBSM-633/01	262557	1 / 20	
	63/0,30	PBSM-633/03	262558	1 / 20	
	63/0,5	PBSM-633/05	262559	1 / 20	
63/1,00	PBSM-633/1	262560	1 / 20		
 <p>WA_SG11902</p>	4-pole				
	40/0,03	PBSM-404/003	262568	2 / 20	
	40/0,10	PBSM-404/01	262569	2 / 20	
	40/0,30	PBSM-404/03	262570	2 / 20	
	40/0,50	PBSM-404/05	262571	2 / 20	
	40/1,00	PBSM-404/1	262572	2 / 20	
	63/0,03	PBSM-634/003	262590	2 / 20	
	63/0,10	PBSM-634/01	262591	2 / 20	
	63/0,30	PBSM-634/03	262592	2 / 20	
	63/0,5	PBSM-634/05	262595	2 / 20	
63/1,00	PBSM-634/1	262596	2 / 20		

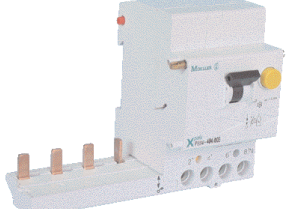
		Add-on Residual Current Protection Unit PBSM		MW	
		conditionally surge-current-proof, 250 A, sensitive to residual pulsating DC, type			
		Max. nominal current of PLS./I _{Δn} (A)	Type designation	Article-No.	Units per package
 <p>WA_SG11702</p>	2-pole				
	40/0,03	PBSM-402/003-A	262328	1 / 20	
	40/0,10	PBSM-402/01-A	262329	1 / 20	
	40/0,30	PBSM-402/03-A	262420	1 / 20	
	40/1,00	PBSM-402/1-A	262421	1 / 20	
	63/0,03	PBSM-632/003-A	262530	1 / 20	
	63/0,10	PBSM-632/01-A	262531	1 / 20	
	63/0,30	PBSM-632/03-A	262532	1 / 20	
	63/1,00	PBSM-632/1-A	262533	1 / 20	
	 <p>WA_SG11802</p>	3-pole			
40/0,03		PBSM-403/003-A	262543	1 / 20	
40/0,10		PBSM-403/01-A	262544	1 / 20	
40/0,30		PBSM-403/03-A	262545	1 / 20	
40/1,00		PBSM-403/1-A	262546	1 / 20	
63/0,03		PBSM-633/003-A	262561	1 / 20	
63/0,10		PBSM-633/01-A	262562	1 / 20	
63/0,30		PBSM-633/03-A	262563	1 / 20	
63/1,00		PBSM-633/1-A	262564	1 / 20	
 <p>WA_SG11902</p>		4-pole			
	40/0,03	PBSM-404/003-A	262573	2 / 20	
	40/0,10	PBSM-404/01-A	262574	2 / 20	
	40/0,30	PBSM-404/03-A	262575	2 / 20	
	40/1,00	PBSM-404/1-A	262576	2 / 20	
	63/0,03	PBSM-634/003-A	262597	2 / 20	
	63/0,10	PBSM-634/01-A	262598	2 / 20	
	63/0,30	PBSM-634/03-A	262600	2 / 20	
	63/1,00	PBSM-634/1-A	262602	2 / 20	

Explanation PBSM:
P = XPole, BS = Add-on Residual Current Protection Unit onto PLS

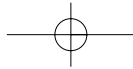

Protective Devices

		Add-on Residual Current Protection Unit PBSM		MW
		surge current-proof 3 kA, type G (ÖVE E 8601)		
		Max. nominal current of PLS./I _{Δn} (A)	Type designation	Article-No. Units per package
 <p>WA_SG11702</p>	2-pole			
	40/0,03	PBSM-402/003-G	262422	1 / 20
 <p>WA_SG11802</p>	3-pole			
	40/0,03	PBSM-403/003-G	262552	1 / 20
 <p>WA_SG11902</p>	4-pole			
	40/0,03	PBSM-404/003-G	262577	2 / 20
		Add-on Residual Current Protection Unit PBSM		MW
		selective and surge current-proof 5 kA, type S		
		Max. nominal current of PLS./I _{Δn} (A)	Type designation	Article-No. Units per package
 <p>WA_SG11702</p>	2-pole			
	40/0,10	PBSM-402/01-S	262423	1 / 20
	40/0,30	PBSM-402/03-S	262424	1 / 20
	40/1,00	PBSM-402/1-S	262425	1 / 20
	63/0,10	PBSM-632/01-S	262534	1 / 20
	63/0,30	PBSM-632/03-S	262535	1 / 20
	63/1,00	PBSM-632/1-S	262536	1 / 20
 <p>WA_SG11802</p>	3-pole			
	40/0,10	PBSM-403/01-S	262553	1 / 20
	40/0,30	PBSM-403/03-S	262554	1 / 20
	40/1,00	PBSM-403/1-S	262555	1 / 20
	63/0,10	PBSM-633/01-S	262565	1 / 20
	63/0,30	PBSM-633/03-S	262566	1 / 20
	63/1,00	PBSM-633/1-S	262567	1 / 20
 <p>WA_SG11902</p>	4-pole			
	40/0,10	PBSM-404/01-S	262586	2 / 20
	40/0,30	PBSM-404/03-S	262587	2 / 20
	40/1,00	PBSM-404/1-S	262588	2 / 20
	63/0,10	PBSM-634/01-S	262603	2 / 20
	63/0,30	PBSM-634/03-S	262605	2 / 20
	63/1,00	PBSM-634/1-S	262607	2 / 20

X pole

Explanation PBSM:
P = XPole, BS = Add-on Residual Current Protection Unit onto PLS.

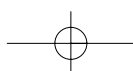

Protective Devices

Add-on Residual Current Protection Unit PBHT

- By combination with miniature circuit breaker PLHT => RCBO unit (MCCB)
- Add-on residual current unit (screw connection) for 80 or 125 A (2-pole and 4-pole)
- High flexibility and ease of installation thanks to variable wiring
- Free selection of main power supply
- Auxiliary switch 1 make contact included as standard in all PBHT versions
- Permits combinations with a variety of characteristics thanks to the different rated currents and characteristics of the miniature circuit breakers PLHT which can be connected
- For commercial and industry applications
- For subsequent mounting onto 2, 3, 3+N and 4-pole-miniature circuit breakers PLHT
- The screw connection to the PLHT-device can be unscrewed at any time. Consequently, in case of modifications of the systems to be protected, the installation can be adapted to new requirements at any time.



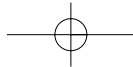

Protective Devices

Add-on Residual Current Protection Unit PBHT

AC-sensitive, conditionally surge-current-proof 250 A

SG5902



SG6002



$I_n/I_{\Delta n}$ (A)	Type Designation	Article No.	Units per package
2-pole			
80/0.03	PBHT-80/2/003	248818	1 / 4
80/0.30	PBHT-80/2/03	248820	1 / 4
80/0.50	PBHT-80/2/05	248822	1 / 4
80/1.00	PBHT-80/2/1	248824	1 / 4
125/0.03	PBHT-125/2/003	248799	1 / 4
125/0.30	PBHT-125/2/03	248801	1 / 4
125/0.50	PBHT-125/2/05	248803	1 / 4
125/1.00	PBHT-125/2/1	248805	1 / 4

4-pole			
80/0.03	PBHT-80/4/003	248826	1 / 4
80/0.30	PBHT-80/4/03	248828	1 / 4
80/0.50	PBHT-80/4/05	248831	1 / 4
80/1.00	PBHT-80/4/1	248834	1 / 4
125/0.03	PBHT-125/4/003	248807	1 / 4
125/0.30	PBHT-125/4/03	248809	1 / 4
125/0.50	PBHT-125/4/05	248812	1 / 4
125/1.00	PBHT-125/4/1	248815	1 / 4

X pole

Add-on Residual Current Protection Unit PBHT

Sensitive to residual pulsating DC, conditionally surge current-proof 250 A

SG5902



SG6002



$I_n/I_{\Delta n}$ (A)	Type Designation	Article No.	Units per package
2-pole			
80/0.03	PBHT-80/2/003-A	248819	1 / 4
80/0.30	PBHT-80/2/03-A	248821	1 / 4
80/0.50	PBHT-80/2/05-A	248823	1 / 4
80/1.00	PBHT-80/2/1-A	248825	1 / 4
125/0.03	PBHT-125/2/003-A	248800	1 / 4
125/0.30	PBHT-125/2/03-A	248802	1 / 4
125/0.50	PBHT-125/2/05-A	248804	1 / 4
125/1.00	PBHT-125/2/1-A	248806	1 / 4

4-pole			
80/0.03	PBHT-80/4/003-A	248827	1 / 4
80/0.30	PBHT-80/4/03-A	248829	1 / 4
80/0.50	PBHT-80/4/05-A	248832	1 / 4
80/1.00	PBHT-80/4/1-A	248835	1 / 4
125/0.03	PBHT-125/4/003-A	248808	1 / 4
125/0.30	PBHT-125/4/03-A	248810	1 / 4
125/0.50	PBHT-125/4/05-A	248813	1 / 4
125/1.00	PBHT-125/4/1-A	248816	1 / 4

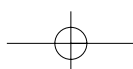

Protective Devices

Xpole

Xpole

wa_sg1101 / WA_SG0301



Add-on Residual Current Protection Unit PBHT Selective + surge current-proof 5 kA, type S/A

$I_n/I_{\Delta n}$ (A)	Type Designation	Article No.	Units per package
4-pole			
80/0.30	PBHT-80/4/03-S/A	248830	1 / 4
80/0.50	PBHT-80/4/05-S/A	248833	1 / 4
80/1.00	PBHT-80/4/1-S/A	248836	1 / 4
125/0.30	PBHT-125/4/03-S/A	248811	1 / 4
125/0.50	PBHT-125/4/05-S/A	248814	1 / 4
125/1.00	PBHT-125/4/1-S/A	248817	1 / 4

Accessories for residual current protection unit PBHT

SG9998

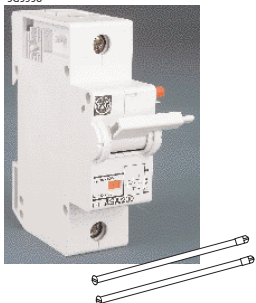

Operational voltage range V~	Type Designation	Article No.	Units per package
Shunt trip release			
110-415	Z-BHASA/230	248445	8
12-60	Z-BHASA/24	248444	8

Protective Devices

Add-on Residual Current Protection Unit PBSM

- Add-on residual current unit
- Line voltage-independent tripping
- By combining this device with a top-quality miniature circuit breaker type PLS. (except PLSN.) a top-quality RCBO unit (combined RCD/MCB device) is formed.
- Rated current 40 and 63 A
- Permits combinations with a variety of characteristics thanks to the different rated currents and characteristics of the PLS.-miniature circuit breakers which can be connected
- Comprehensive range of accessories suitable for subsequent installation onto PLS.
- **Type -A:** Protect against special forms of residual pulsating DC which have not been smoothed.
- **Type -G:** High reliability against unwanted tripping. Compulsory for any circuit where personal injury or damage to property may occur in case of unwanted tripping (ÖVE-EN1, Part1, §12.14).
- **Type -S:** Selective residual current device, either sensitive to AC, type -S, or sensitive to pulsating DC, type -S/A, for protection against special forms of residual pulsating DC which have not been smoothed. Compulsory for systems with surge arresters downstream of the RCD (ÖVE-EN1, Part 1, §12.15).

Accessories (on PLS.):

Auxiliary switch for subsequent installation	ZP-AHK	248436
Tripping signal contact for subsequent installation	ZP-NHK	248437
Remote control and automatic switching device	Z-FW/LP	248296
Shunt trip release	ZP-ASA/..	248438, 248439
Undervoltage release	Z-USA/..	248288-248291
Compact enclosure	KLV-TC-2	276240
	KLV-TC-4	276241
Additional terminal 35mm ²	HA7-ZK35	751942199
Anti-tamper device	HA7-SPE	750960510

Connection diagrams

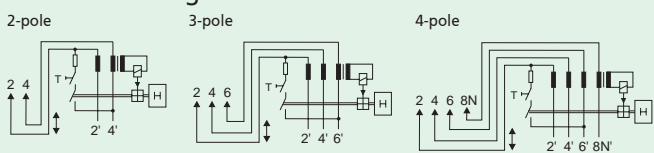

Accessories :

Cover cap for draw-out connection bar	included
Slotted one-way cheese head screw	included

Technical Data

Electrical

Design according to	IEC/EN 61009
Current test marks as printed onto the device	
Tripping	instantaneous 250A (8/20μ), surge current-proof
	Type G 10 ms delay 3kA (8/20μ), surge current-proof
	Type S 40 ms delay 6kA - with selective disconnecting function
Rated voltage U_n	230/400 V AC
Operational voltage range	196 - 440 V
Rated frequency	50 Hz
Rated current I_n	≤ 40 A, ≤ 63 A
Rated tripping current $I_{\Delta n}$	30, 100, 300, 500, 1000 mA
Rated non-tripping current $I_{\Delta no}$	0.5 $I_{\Delta n}$
Sensitivity	AC and pulsating DC
Service short circuit breaking capacity I_{cs}	same as connected PLS. (7.5 kA)
Rated breaking capacity I_{cn}	same as connected PLS. (10 kA)
Rated fault breaking capacity $I_{\Delta m}$	6 kA ($U_n = 230V$) 3 kA ($U_n = 400V$)

Mechanical

Frame-size	45 mm
Device height	90 mm
Device width	70 mm (2p), 107.5 mm (3p), 125 mm (4p)
Mounting	fix mounted onto PLS.
Degree of protection installed device	IP40
Fastening screw	M 2.5 (slotted one-way cheese head screw;
	Screw head breaking torque > 0.6 Nm
Upper and lower terminals	lift terminals
Terminal screws	M 5 (combined Philips/standard head screws according to DIN7962-Z2, Pozidrive)
Terminal protection	finger and hand touch safe, BGV A3, ÖVE-EN 6
Terminal capacity	
Rigid conductors	1 x (1 - 25) mm ²
Flexible conductors (with wire end sleeve)	1 x (0.75 - 16) mm ²
Busbar thickness	0.8 - 2 mm
Permitted ambient temperature range	-25°C to +40°C
Resistance to climatic conditions	acc. to IEC/EN 60068-2 (25..55°C/90..95% relative humidity)

Dimensions (mm)

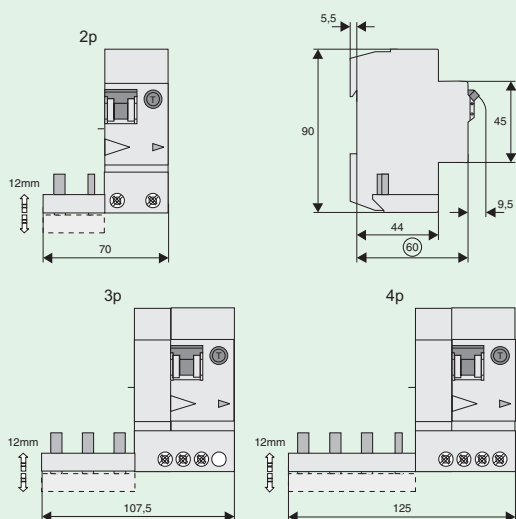

Protective Devices

Add-on Residual Current Protection Unit PBHT

- By combination with miniature circuit breaker PLHT => RCBO-Unit (MCCB)
- Add-on residual current unit (screw connection) for 80 or 125 A (2-pole and 4-pole)
- High flexibility and ease of installation thanks to variable wiring (400 mm flexible connection wires 2p = 2 units, 4p = 4 units included in the set)
- Free selection of main power supply
- Auxiliary switch 1 NO included as standard in all PBHT versions
- Permits combinations with a variety of characteristics thanks to the different rated currents and characteristics of the miniature circuit breakers PLHT which can be connected
- For trade and industry applications
- For subsequent mounting onto 2, 3, 3+N and 4-pole-miniature circuit breakers PLHT
- Toggle (serves as switch position- and tripping indicator)
- The screw connection to the PLHT-device can be unscrewed at any time. Consequently, in case of modifications of the systems to be protected, the installation can be adapted to new requirements at any time.

Accessories:

Flexible connection wires (connection to PLHT) are included in the standard set:

2-pole	80A	2 x 16mm ² (400mm each)
4-pole	80A	4 x 16mm ² (400mm each)
2-pole	125A	2 x 35mm ² (400mm each)
4-pole	125A	4 x 35mm ² (400mm each)

Connection diagrams

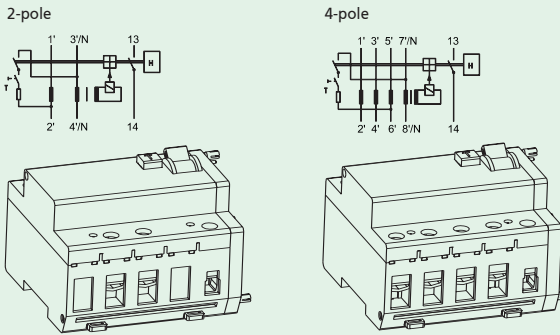

Technical Data

Electrical

Design according to	IEC/EN 60947-2
Current test marks as printed onto the device	
Current flow paths	
Rated voltage U_e	230/400 V AC
Operational voltage range	196-440 V
Rated frequency	50 Hz
Rated current I_n	80 A, 125 A
Rated tripping current $I_{\Delta n}$	30, 300, 500, 1000 mA
Rated non-tripping current $I_{\Delta no}$	0.5 $I_{\Delta n}$
Sensitivity	AC and pulsating DC
Tripping characteristic	instantaneous 250A (8/20 μ), surge current-proof;
	Type S 40 ms delay 6kA (8/20 μ) with selective disconnecting function, surge current-proof
Rated service short circuit breaking capacity I_{cn}	same as connected PLHT
Rated ultimate circuit breaking capacity I_{cu}	same as connected PLHT
Rated fault short circuit breaking capacity $I_{\Delta n} = I_{cu}$	
Rated peak withstand voltage U_{imp}	4 kV (1.2/50 μ)
Endurance mechanical comp.	
PBHT-80	>10000
PBHT-125	>8000
Endurance electrical comp.	
PBHT-80	>1500
PBHT-125	>1000

Auxiliary Contact

Utilisation category AC15	
Rated voltage U_e	250 V AC
Rated operational current I_e	16 A AC

Mechanical

Frame size	45 mm
Device height	90 mm
Device width	95 mm (5,5MU)
Depth of central body	60 mm
Mounting	screwed onto PLHT
Upper and lower terminals	2-, 3-, 4-pole; PBHT-ASA lift terminals
Terminal protection	finger and hand touch safe, BGV A3, ÖVE-EN 6
Terminal capacity	
Main conductor	2.5 - 50 mm ²
Auxiliary switch	1 - 25 mm ²
Degree of protection, built-in	IP40
Permissible ambient temperature range	-25°C to +40°C
Resistance to climatic conditions	acc. to IEC 60068-2 (25...55°C/90...95% relative humidity)

Dimensions (mm)

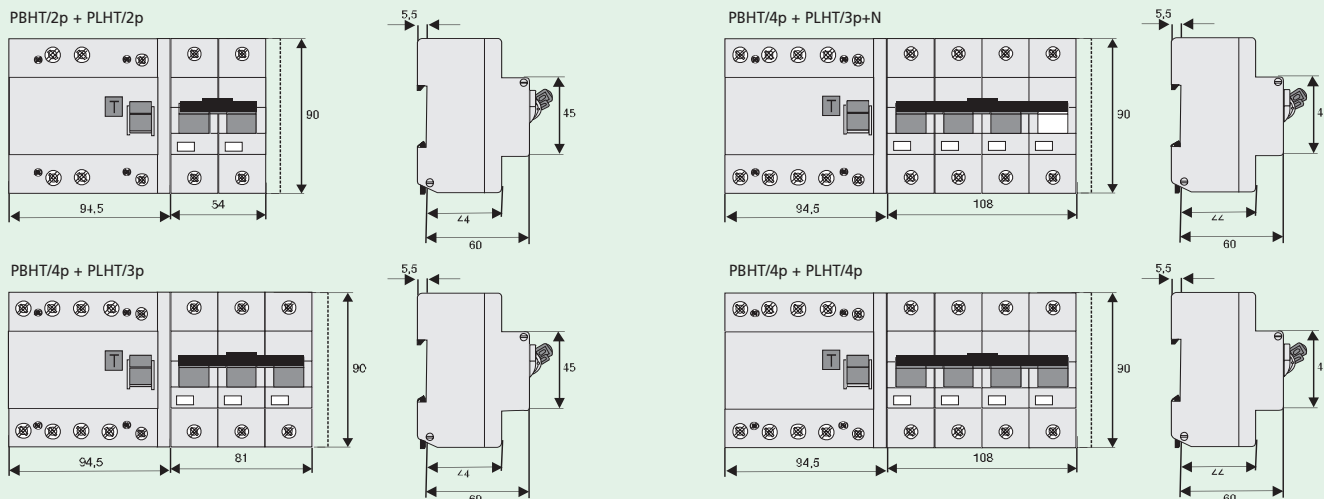

Protective Devices

Wiring options

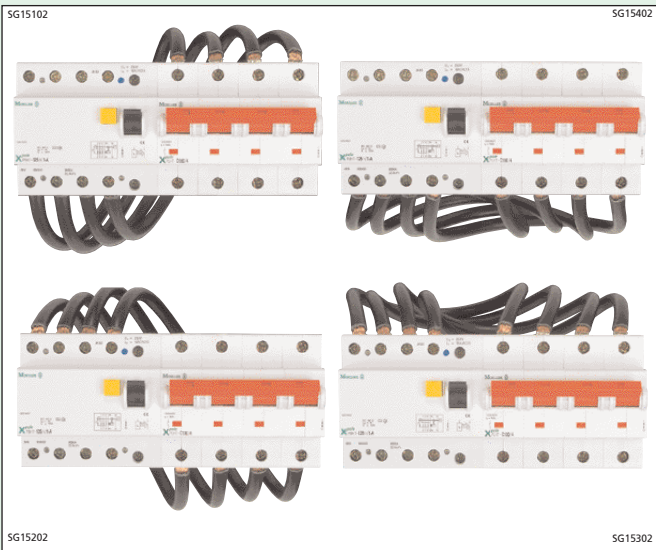

Mounting PBHT + PLHT

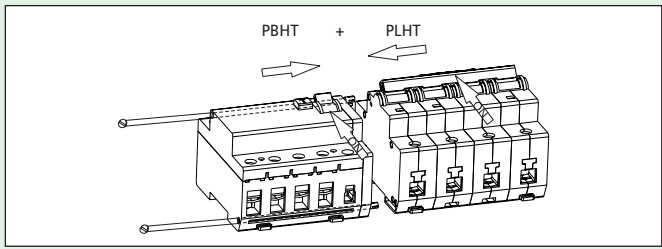

Connection PBHT/4p + PLHT/3p

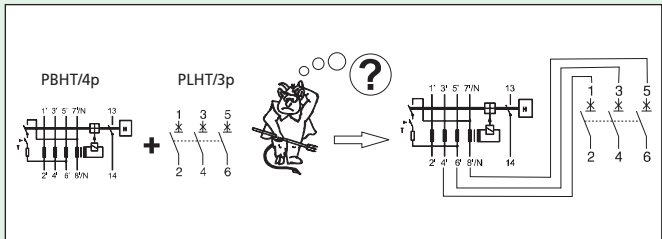

Mounting arrangement residual current protection unit - shunt trip release - miniature circuit breaker - auxiliary contact

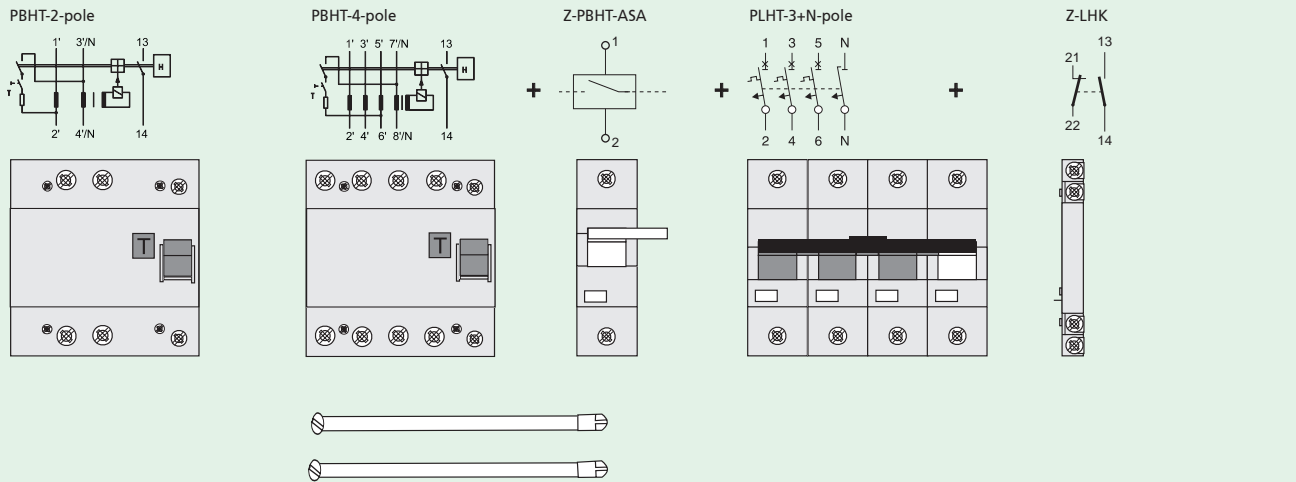

X pole

X pole

Protective Devices

Accessories for PBHT

Shunt Trip Release Z-PBHT-ASA

- Can be mounted subsequently
- Contact position indicator red - green
- Marking labels can be fitted
- Wide operational voltage range
- Sufficient power of extra low voltage source must be ensured
PBHT-ASA/24: min. 90 VA
- Screws for mounting included PBHT => PBHT-ASA => PLHT

Connection diagram

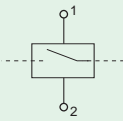

Technical Data

	Z-PBHT-ASA/24	Z-PBHT-ASA/230
Electrical		
Minimum pulse duration	15 ms	10 ms
Internal resistance	2 Ω	130 Ω
Duty	100%	100%
Tripping time	< 20 ms	< 20 ms
Peak withstand voltage (1.2/50μ)	2 kV	2 kV
Endurance	>4,000 operating cycles	>4,000 operating cycles
AC voltage range:		
Responding limit	8 V	70 V
Operational voltage range	12-60 V	110-415 V
Maximum current consumption during switch-on	1.4-7 A	3.4 A (at 230V)
Current flow time at max. current consumption	4.0 ms	4.5 ms
DC voltage range:		
Responding limit	11 V	90 V
Operational voltage range	12-60 V	110-230 V
Maximum current consumption during switch-on	1.7 A typ.	1.7 A typ.
Current flow time at max. current consumption	2 ms	4 ms
Mechanical		
Frame size	45 mm	45 mm
Device height	90 mm	90 mm
Device width	27 mm	27 mm
Mounting	quick fastening on DIN rail EN 50022	
Degree of protection, built-in	IP40	IP40
Upper and lower terminal screws	lift terminals	lift terminals
Terminal capacity	2.5-30 mm ²	2.5-30 mm ²
Fastening torque of terminal screws	4 Nm	4 Nm

Dimensions (mm)

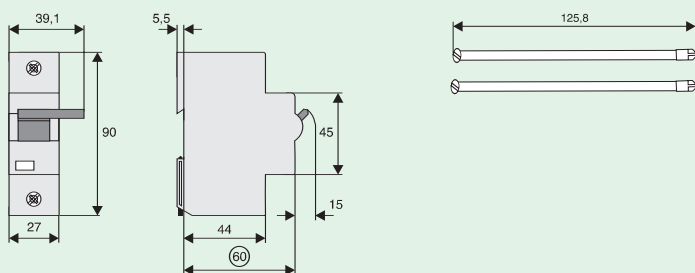

X pole