

GRM31BR72J102KW01#

"#" indicates a package specification code.



< List of part numbers with package codes >
GRM31BR72J102KW01L

Shape

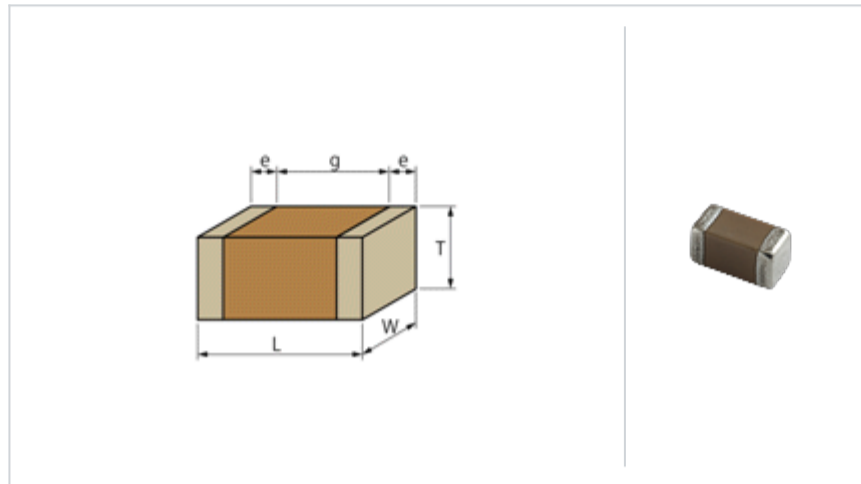

L size	3.2 ± 0.2mm
W size	1.6 ± 0.2mm
T size	1.25 +0/-0.3mm
External terminal width e	0.3mm min.
Distance between external terminals g	1.2mm min.
Size code in inch(mm)	1206 (3216)

References

Packaging	Specifications	Minimum quantity
L	180mm Embossed taping	3000

Specifications

Capacitance	1000pF ± 10%
Rated voltage	630Vdc
Temperature characteristics (complied standard)	X7R(EIA)
Capacitance change rate	± 15%
Temperature range of temperature characteristics	-55 to 125
Operating temperature range	-55 to 125

⚠ Attention

- 1.This datasheet is downloaded from the website of Murata Manufacturing Co., Ltd. Therefore, it ' s specifications are subject to change or our products in it may be discontinued without advance notice. Please check with our sales representatives or product engineers before ordering.
- 2.This datasheet has only typical specifications because there is no space for detailed specifications. Therefore, please review our product specifications or consult the approval sheet for product specifications before ordering.

▪ Frequency characteristics (ESR, Impedance)

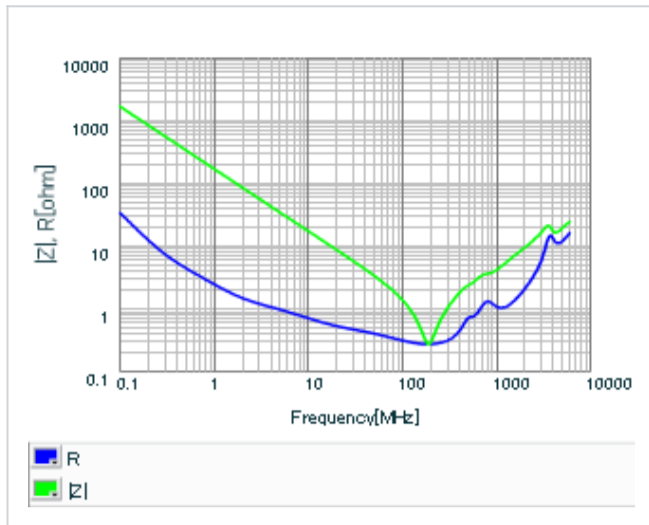

▪ DC bias characteristics

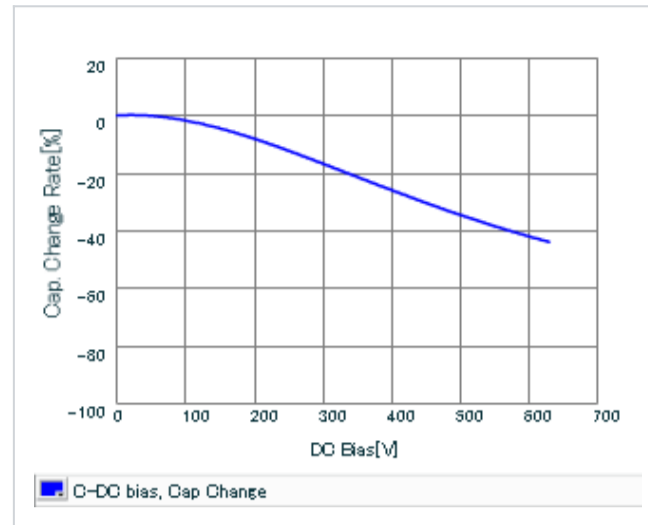

▪ AC voltage characteristics

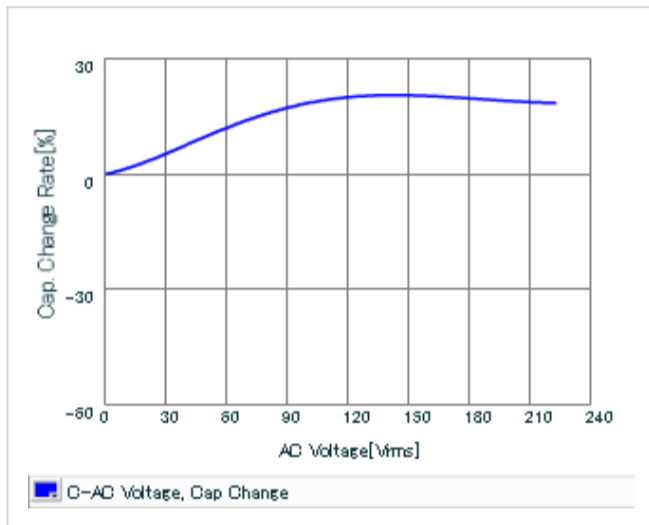

▪ Capacitance - temperature characteristics

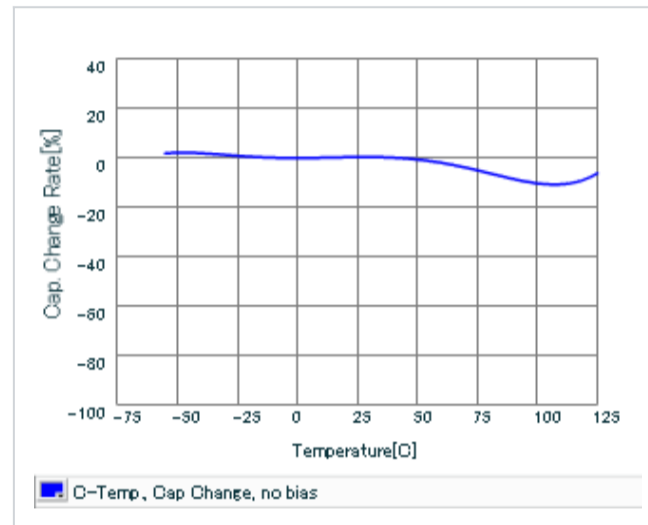

▪ Calorific property by ripple current

