

74VHC541; 74VHCT541

Octal buffer/line driver; 3-state

Rev. 01 — 12 August 2009

Product data sheet

1. General description

The 74VHC541; 74VHCT541 are high-speed Si-gate CMOS devices.

The 74VHC541; 74VHCT541 are octal non-inverting buffer/line drivers with 3-state bus compatible outputs.

The 3-state outputs are controlled by the output enable inputs $\overline{OE}0$ and $\overline{OE}1$.

A HIGH on $\overline{OE}n$ causes the outputs to assume a high-impedance OFF-state.

2. Features

- Balanced propagation delays
- All inputs have a Schmitt-trigger action
- Inputs accepts voltages higher than V_{CC}
- The 74VHC541 operates with CMOS input level
- The 74VHCT541 operates with TTL input level
- ESD protection:
 - ◆ HBM JESD22-A114E exceeds 2000 V
 - ◆ MM JESD22-A115-A exceeds 200 V
 - ◆ CDM JESD22-C101C exceeds 1000 V
- Multiple package options
- Specified from $-40\text{ }^{\circ}\text{C}$ to $+85\text{ }^{\circ}\text{C}$ and from $-40\text{ }^{\circ}\text{C}$ to $+125\text{ }^{\circ}\text{C}$

3. Ordering information

Table 1. Ordering information

Type number	Package			Version
	Temperature range	Name	Description	
74VHC541D 74VHCT541D	$-40\text{ }^{\circ}\text{C}$ to $+125\text{ }^{\circ}\text{C}$	SO20	plastic small outline package; 20 leads; body width 7.5 mm	SOT163-1
74VHC541PW 74VHCT541PW	$-40\text{ }^{\circ}\text{C}$ to $+125\text{ }^{\circ}\text{C}$	TSSOP20	plastic thin shrink small outline package; 20 leads; body width 4.4 mm	SOT360-1
74VHC541BQ 74VHCT541BQ	$-40\text{ }^{\circ}\text{C}$ to $+125\text{ }^{\circ}\text{C}$	DHVQFN20	plastic dual-in-line compatible thermal enhanced very thin quad flat package; no leads; 20 terminals; body $2.5 \times 4.5 \times 0.85$ mm	SOT764-1

4. Functional diagram

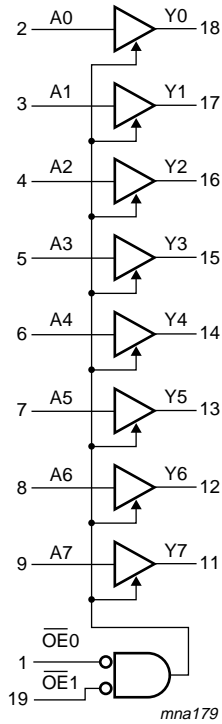

Fig 1. Logic symbol

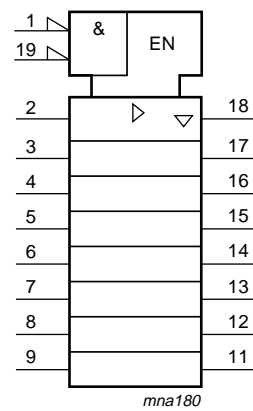
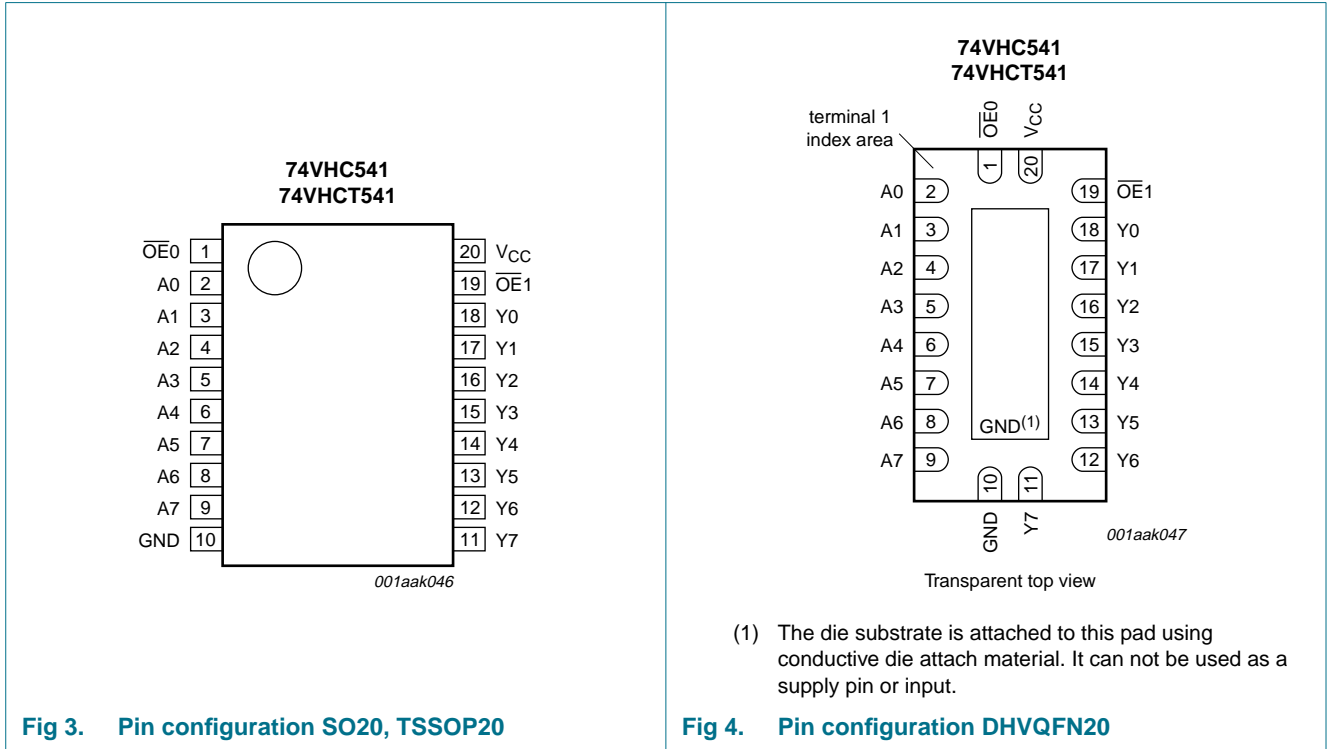

Fig 2. IEC logic symbol

5. Pinning information

5.1 Pinning



5.2 Pin description

Table 2. Pin description

Symbol	Pin	Description
$\overline{OE}0$	1	output enable input (active LOW)
A[0:7]	2, 3, 4, 5, 6, 7, 8, 9	data input
GND	10	ground (0 V)
Y[0:7]	18, 17, 16, 15, 14, 13, 12, 11	data output
$\overline{OE}1$	19	output enable input (active LOW)
V _{CC}	20	supply voltage

6. Functional description

Table 3. Functional table^[1]

Control		Input		Output
$\overline{OE}0$	$\overline{OE}1$	An		Yn
L	L	L		L
L	L	H		H
X	H	X		Z
H	X	X		Z

- [1] H = HIGH voltage level;
 L = LOW voltage level;
 X = don't care;
 Z = high-impedance OFF-state.

7. Limiting values

Table 4. Limiting values

In accordance with the Absolute Maximum Rating System (IEC 60134). Voltages are referenced to GND (ground = 0 V).

Symbol	Parameter	Conditions	Min	Max	Unit
V_{CC}	supply voltage		-0.5	+7.0	V
V_I	input voltage		-0.5	+7.0	V
I_{IK}	input clamping current	$V_I < -0.5$ V	[1] -20	-	mA
I_{OK}	output clamping current	$V_O < -0.5$ V or $V_O > V_{CC} + 0.5$ V	[1] -	±20	mA
I_O	output current	$V_O = -0.5$ V to $(V_{CC} + 0.5$ V)	-	±25	mA
I_{CC}	supply current		-	75	mA
I_{GND}	ground current		-75	-	mA
T_{stg}	storage temperature		-65	+150	°C
P_{tot}	total power dissipation	$T_{amb} = -40$ °C to +125 °C			
	SO20 package		[2] -	500	mW
	TSSOP20 package		[3] -	500	mW
	DHVQFN20 package		[4] -	500	mW

- [1] The input and output voltage ratings may be exceeded if the input and output current ratings are observed.
 [2] P_{tot} derates linearly with 8 mW/K above 70 °C.
 [3] P_{tot} derates linearly with 5.5 mW/K above 60 °C.
 [4] P_{tot} derates linearly with 4.5 mW/K above 60 °C.

8. Recommended operating conditions

Table 5. Recommended operating conditions

Voltages are referenced to GND (ground = 0 V).

Symbol	Parameter	Conditions	74VHC541			74VHCT541			Unit
			Min	Typ	Max	Min	Typ	Max	
V _{CC}	supply voltage		2.0	5.0	5.5	4.5	5.0	5.5	V
V _I	input voltage		0	-	5.5	0	-	5.5	V
V _O	output voltage		0	-	V _{CC}	0	-	V _{CC}	V
T _{amb}	ambient temperature		-40	+25	+125	-40	+25	+125	°C
Δt/ΔV	input transition rise and fall rate	V _{CC} = 3.3 V ± 0.3 V	-	-	100	-	-	-	ns/V
		V _{CC} = 5.0 V ± 0.5 V	-	-	20	-	-	20	ns/V

9. Static characteristics

Table 6. Static characteristics

Voltages are referenced to GND (ground = 0 V).

Symbol	Parameter	Conditions	25 °C			-40 °C to +85 °C		-40 °C to +125 °C		Unit
			Min	Typ	Max	Min	Max	Min	Max	
For type 74VHC541										
V _{IH}	HIGH-level input voltage	V _{CC} = 2.0 V	1.5	-	-	1.5	-	1.5	-	V
		V _{CC} = 3.0 V	2.1	-	-	2.1	-	2.1	-	V
		V _{CC} = 5.5 V	3.85	-	-	3.85	-	3.85	-	V
V _{IL}	LOW-level input voltage	V _{CC} = 2.0 V	-	-	0.5	-	0.5	-	0.5	V
		V _{CC} = 3.0 V	-	-	0.9	-	0.9	-	0.9	V
		V _{CC} = 5.5 V	-	-	1.65	-	1.65	-	1.65	V
V _{OH}	HIGH-level output voltage	V _I = V _{IH} or V _{IL}								
		I _O = -50 μA; V _{CC} = 2.0 V	1.9	2.0	-	1.9	-	1.9	-	V
		I _O = -50 μA; V _{CC} = 3.0 V	2.9	3.0	-	2.9	-	2.9	-	V
		I _O = -50 μA; V _{CC} = 4.5 V	4.4	4.5	-	4.4	-	4.4	-	V
		I _O = -4.0 mA; V _{CC} = 3.0 V	2.58	-	-	2.48	-	2.40	-	V
I _O = -8.0 mA; V _{CC} = 4.5 V	3.94	-	-	3.8	-	3.70	-	V		
V _{OL}	LOW-level output voltage	V _I = V _{IH} or V _{IL}								
		I _O = 50 μA; V _{CC} = 2.0 V	-	0	0.1	-	0.1	-	0.1	V
		I _O = 50 μA; V _{CC} = 3.0 V	-	0	0.1	-	0.1	-	0.1	V
		I _O = 50 μA; V _{CC} = 4.5 V	-	0	0.1	-	0.1	-	0.1	V
		I _O = 4.0 mA; V _{CC} = 3.0 V	-	-	0.36	-	0.44	-	0.55	V
I _O = 8.0 mA; V _{CC} = 4.5 V	-	-	0.36	-	0.44	-	0.55	V		
I _{OZ}	OFF-state output current	V _I = V _{IH} or V _{IL} ; V _O = V _{CC} or GND; V _{CC} = 5.5 V	-	-	±0.25	-	±2.5	-	±10.0	μA
I _I	input leakage current	V _I = V _{CC} or GND; V _{CC} = 0 V to 5.5 V	-	-	0.1	-	1.0	-	2.0	μA
I _{CC}	supply current	V _I = V _{CC} or GND; I _O = 0 A; V _{CC} = 5.5 V	-	-	4.0	-	40	-	80	μA

Table 6. Static characteristics ...continued
 Voltages are referenced to GND (ground = 0 V).

Symbol	Parameter	Conditions	25 °C			-40 °C to +85 °C		-40 °C to +125 °C		Unit
			Min	Typ	Max	Min	Max	Min	Max	
C _I	input capacitance		-	3.0	10	-	10	-	10	pF
C _O	output capacitance		-	4.0	-	-	-	-	-	pF
For type 74VHCT541										
V _{IH}	HIGH-level input voltage	V _{CC} = 4.5 V to 5.5 V	2.0	-	-	2.0	-	2.0	-	V
V _{IL}	LOW-level input voltage	V _{CC} = 4.5 V to 5.5 V	-	-	0.8	-	0.8	-	0.8	V
V _{OH}	HIGH-level output voltage	V _I = V _{IH} or V _{IL} ; V _{CC} = 4.5 V								
		I _O = -50 μA	4.4	4.5	-	4.4	-	4.4	-	V
		I _O = -8.0 mA	3.94	-	-	3.8	-	3.70	-	V
V _{OL}	LOW-level output voltage	V _I = V _{IH} or V _{IL} ; V _{CC} = 4.5 V								
		I _O = 50 μA	-	0	0.1	-	0.1	-	0.1	V
		I _O = 8.0 mA	-	-	0.36	-	0.44	-	0.55	V
I _{OZ}	OFF-state output current	per input pin; V _I = V _{IH} or V _{IL} ; V _{CC} = 5.5 V; I _O = 0 A; V _O = V _{CC} or GND; other pins at V _{CC} or GND	-	-	±0.25	-	±2.5	-	±10.0	μA
I _I	input leakage current	V _I = V _{CC} or GND; V _{CC} = 0 V to 5.5 V	-	-	0.1	-	1.0	-	2.0	μA
I _{CC}	supply current	V _I = V _{CC} or GND; I _O = 0 A; V _{CC} = 5.5 V	-	-	4.0	-	40	-	80	μA
ΔI _{CC}	additional supply current	per input pin; V _I = V _{CC} - 2.1 V; I _O = 0 A; other pins at V _{CC} or GND; V _{CC} = 4.5 V to 5.5 V	-	-	1.35	-	1.5	-	1.5	mA
C _I	input capacitance		-	3	10	-	10	-	10	pF
C _O	output capacitance		-	4.0	-	-	-	-	-	pF

10. Dynamic characteristics

Table 7. Dynamic characteristics
GND = 0 V. For test circuit see Figure 7.

Symbol	Parameter	Conditions	25 °C			-40 °C to +85 °C		-40 °C to +125 °C		Unit
			Min	Typ ^[1]	Max	Min	Max	Min	Max	
For type 74VHC541										
t_{pd}	propagation delay	An to Yn; see Figure 5 ^[2]								
		$V_{CC} = 3.0\text{ V to }3.6\text{ V}$								
		$C_L = 15\text{ pF}$	-	5.0	7.0	1.0	8.5	1.0	9.0	ns
		$C_L = 50\text{ pF}$	-	7.0	10.5	1.0	12.0	1.0	13.5	ns
		$V_{CC} = 4.5\text{ V to }5.5\text{ V}$								
		$C_L = 15\text{ pF}$	-	3.5	5.0	1.0	6.0	1.0	6.5	ns
t_{en}	enable time	$\overline{O}En$ to Yn; see Figure 6 ^[2]								
		$V_{CC} = 3.0\text{ V to }3.6\text{ V}$								
		$C_L = 15\text{ pF}$	-	5.5	10.5	1.0	11.0	1.0	13.5	ns
		$C_L = 50\text{ pF}$	-	7.5	14.0	1.0	16.0	1.0	17.5	ns
		$V_{CC} = 4.5\text{ V to }5.5\text{ V}$								
		$C_L = 15\text{ pF}$	-	3.5	7.2	1.0	8.5	1.0	9.0	ns
t_{dis}	disable time	$\overline{O}En$ to Yn; see Figure 6 ^[2]								
		$V_{CC} = 3.0\text{ V to }3.6\text{ V}$								
		$C_L = 15\text{ pF}$	-	6.0	11.0	1.0	12.0	1.0	14.0	ns
		$C_L = 50\text{ pF}$	-	9.5	15.4	1.0	17.5	1.0	19.5	ns
		$V_{CC} = 4.5\text{ V to }5.5\text{ V}$								
		$C_L = 15\text{ pF}$	-	4.5	7.5	1.0	8.0	1.0	9.5	ns
C_{PD}	power dissipation capacitance	$C_L = 50\text{ pF}$; $f_i = 1\text{ MHz}$; $V_i = \text{GND to }V_{CC}$ ^[3]	-	10	-	-	-	-	-	pF

Table 7. Dynamic characteristics ...continued
GND = 0 V. For test circuit see Figure 7.

Symbol	Parameter	Conditions	25 °C			-40 °C to +85 °C		-40 °C to +125 °C		Unit
			Min	Typ ^[1]	Max	Min	Max	Min	Max	
For type 74VHCT541										
t _{pd}	propagation delay	An to Yn; see Figure 5 ^[2]								
		V _{CC} = 4.5 V to 5.5 V								
		C _L = 15 pF	-	3.5	5.5	1.0	6.5	1.0	7.0	ns
		C _L = 50 pF	-	5.0	8.5	1.0	9.5	1.0	11.0	ns
t _{en}	enable time	OE _n to Yn; see Figure 6								
		V _{CC} = 4.5 V to 5.5 V								
		C _L = 15 pF	-	4.0	7.0	1.0	8.0	1.0	9.0	ns
		C _L = 50 pF	-	5.5	10.0	1.0	12.0	1.0	12.5	ns
t _{dis}	disable time	OE _n to Yn; see Figure 6 ^[2]								
		V _{CC} = 4.5 V to 5.5 V								
		C _L = 15 pF	-	5.0	7.0	1.0	8.0	1.0	9.0	ns
		C _L = 50 pF	-	7.0	10.0	1.0	12.0	1.0	12.5	ns
C _{PD}	power dissipation capacitance	per buffer; C _L = 50 pF; f = 1 MHz; V _I = GND to V _{CC}	^[3]	-	12	-	-	-	-	pF

[1] Typical values are measured at nominal supply voltage (V_{CC} = 3.3 V and V_{CC} = 5.0 V).

[2] t_{pd} is the same as t_{PLH} and t_{PHL}.
 t_{en} is the same as t_{PZL} and t_{PZH}.
 t_{dis} is the same as t_{PLZ} and t_{PHZ}.

[3] C_{PD} is used to determine the dynamic power dissipation P_D (μW).
 $P_D = C_{PD} \times V_{CC}^2 \times f_i + \sum(C_L \times V_{CC}^2 \times f_o)$ where:
 f_i = input frequency in MHz;
 f_o = output frequency in MHz;
 C_L = output load capacitance in pF;
 V_{CC} = supply voltage in Volts.

11. Waveforms

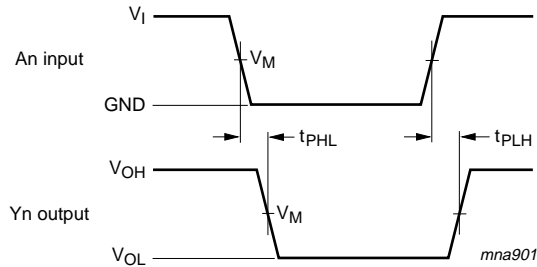

Measurement points are given in [Table 8](#).

V_{OL} and V_{OH} are typical voltage output levels that occur with the output load.

Fig 5. Propagation delay input (An) to output (Yn)

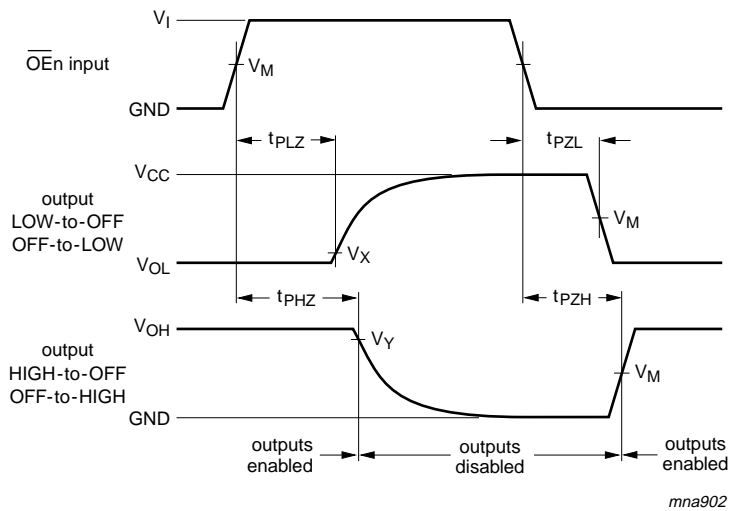

Measurement points are given in [Table 8](#).

V_{OL} and V_{OH} are typical voltage output levels that occur with the output load.

Fig 6. Enable and disable times

Table 8. Measurement points

Type	Input	Output		
	V_M	V_M	V_X	V_Y
74VHC541	$0.5V_{CC}$	$0.5V_{CC}$	$V_{OL} + 0.3 V$	$V_{OH} - 0.3 V$
74VHCT541	1.5 V	$0.5V_{CC}$	$V_{OL} + 0.3 V$	$V_{OH} - 0.3 V$

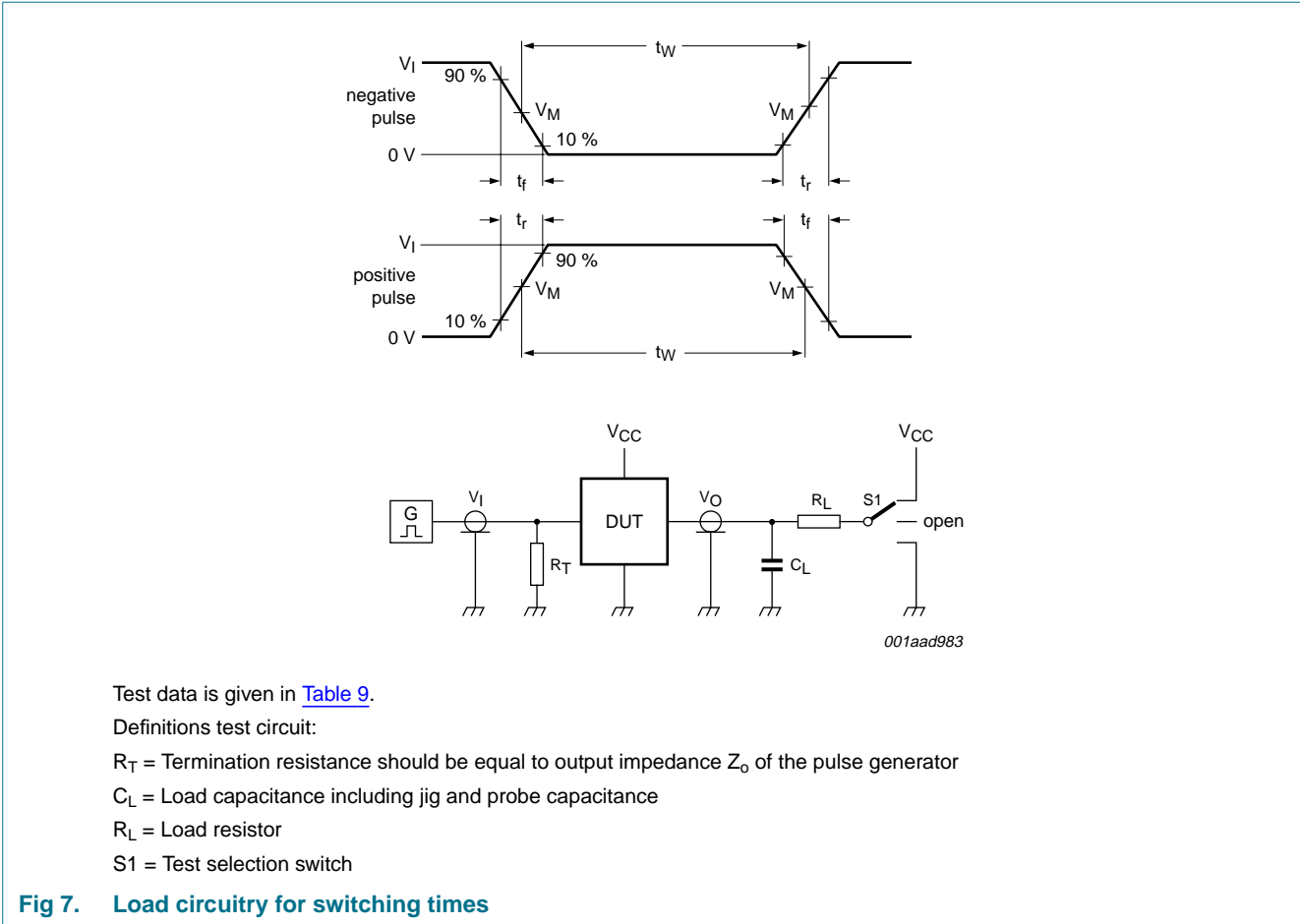

Fig 7. Load circuitry for switching times

Table 9. Test data

Type	Input		Load		S1 position		
	V_I	t_r, t_f	C_L	R_L	t_{PHL}, t_{PLH}	t_{PZH}, t_{PHZ}	t_{PZL}, t_{PLZ}
74VHC541	V_{CC}	3.0 ns	15 pF, 50 pF	1 k Ω	open	GND	V_{CC}
74VHCT541	3.0 V	3.0 ns	15 pF, 50 pF	1 k Ω	open	GND	V_{CC}

12. Package outline

SO20: plastic small outline package; 20 leads; body width 7.5 mm

SOT163-1

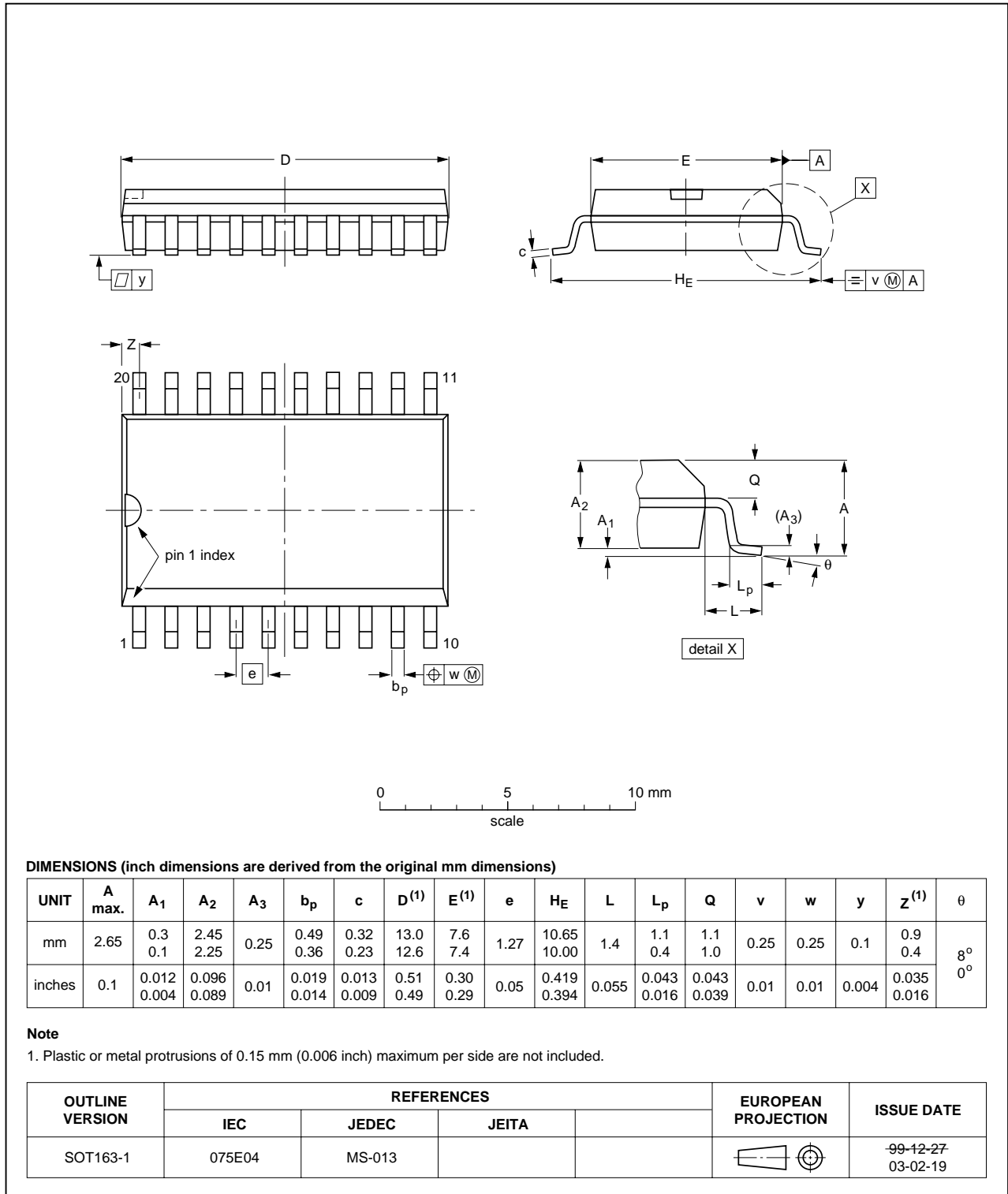

Fig 8. Package outline SOT163-1 (SO20)

TSSOP20: plastic thin shrink small outline package; 20 leads; body width 4.4 mm

SOT360-1

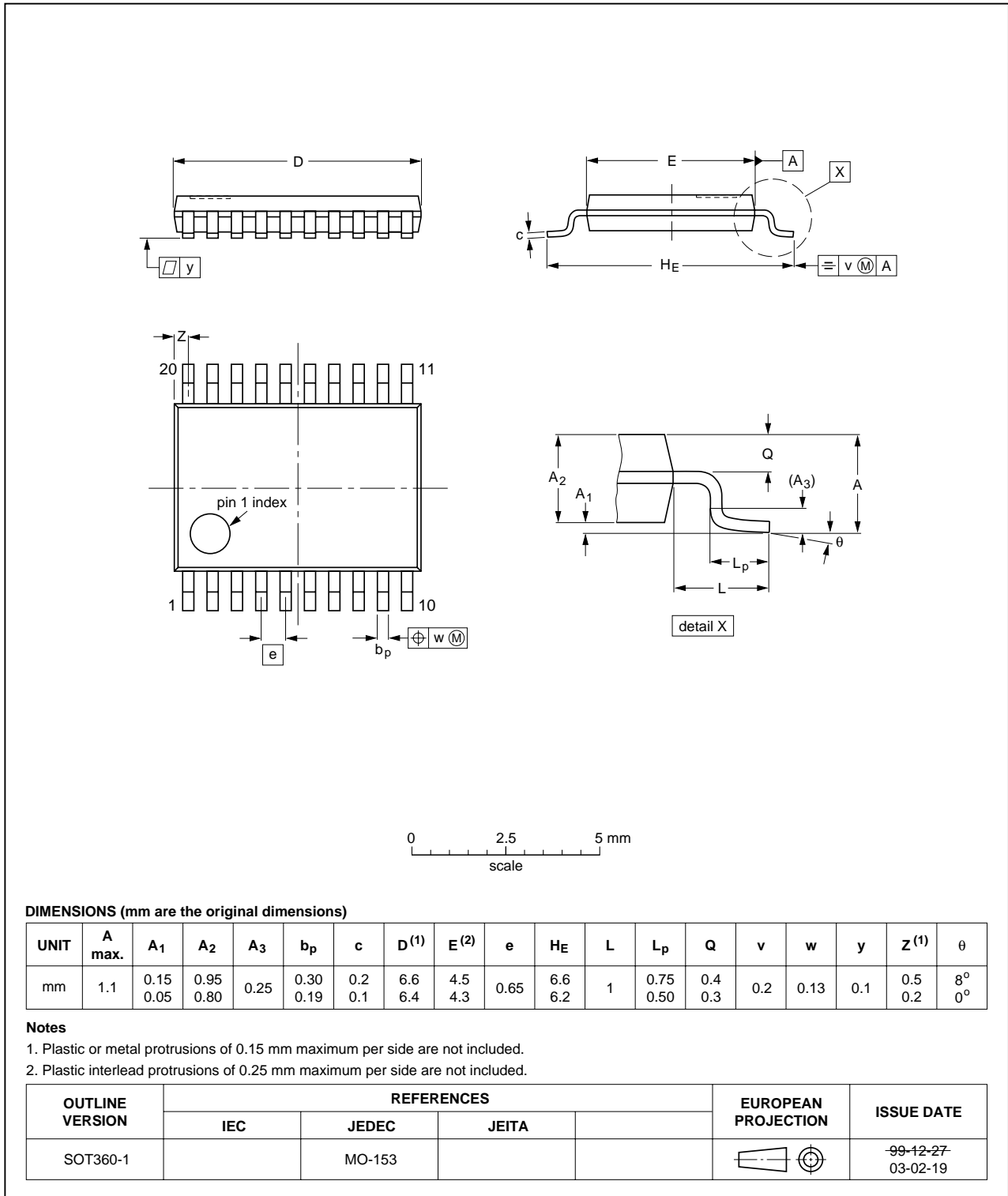

Fig 9. Package outline SOT360-1 (TSSOP20)

DHVQFN20: plastic dual in-line compatible thermal enhanced very thin quad flat package; no leads; 20 terminals; body 2.5 x 4.5 x 0.85 mm

SOT764-1

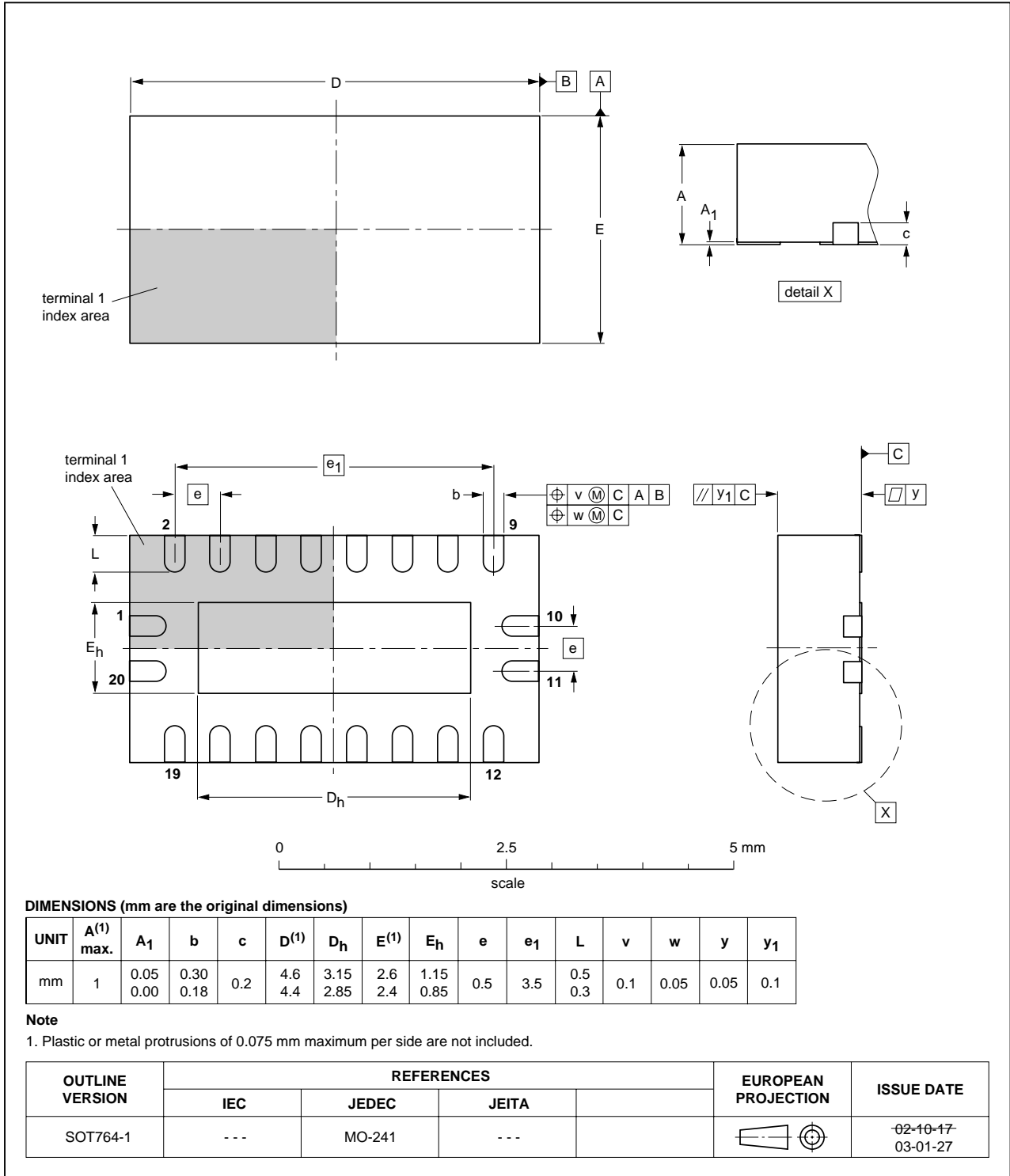

Fig 10. Package outline SOT764-1 (DHVQFN20)

13. Abbreviations

Table 10. Abbreviations

Acronym	Description
CDM	Charged Device Model
CMOS	Complementary Metal Oxide Semiconductor
DUT	Device Under Test
ESD	ElectroStatic Discharge
HBM	Human Body Model
MM	Machine Model
TTL	Transistor-Transistor Logic

14. Revision history

Table 11. Revision history

Document ID	Release date	Data sheet status	Change notice	Supersedes
74VHC_VHCT541_1	20090812	Product data sheet	-	-

15. Legal information

15.1 Data sheet status

Document status ^{[1][2]}	Product status ^[3]	Definition
Objective [short] data sheet	Development	This document contains data from the objective specification for product development.
Preliminary [short] data sheet	Qualification	This document contains data from the preliminary specification.
Product [short] data sheet	Production	This document contains the product specification.

[1] Please consult the most recently issued document before initiating or completing a design.

[2] The term 'short data sheet' is explained in section "Definitions".

[3] The product status of device(s) described in this document may have changed since this document was published and may differ in case of multiple devices. The latest product status information is available on the Internet at URL <http://www.nxp.com>.

15.2 Definitions

Draft — The document is a draft version only. The content is still under internal review and subject to formal approval, which may result in modifications or additions. NXP Semiconductors does not give any representations or warranties as to the accuracy or completeness of information included herein and shall have no liability for the consequences of use of such information.

Short data sheet — A short data sheet is an extract from a full data sheet with the same product type number(s) and title. A short data sheet is intended for quick reference only and should not be relied upon to contain detailed and full information. For detailed and full information see the relevant full data sheet, which is available on request via the local NXP Semiconductors sales office. In case of any inconsistency or conflict with the short data sheet, the full data sheet shall prevail.

15.3 Disclaimers

General — Information in this document is believed to be accurate and reliable. However, NXP Semiconductors does not give any representations or warranties, expressed or implied, as to the accuracy or completeness of such information and shall have no liability for the consequences of use of such information.

Right to make changes — NXP Semiconductors reserves the right to make changes to information published in this document, including without limitation specifications and product descriptions, at any time and without notice. This document supersedes and replaces all information supplied prior to the publication hereof.

Suitability for use — NXP Semiconductors products are not designed, authorized or warranted to be suitable for use in medical, military, aircraft, space or life support equipment, nor in applications where failure or malfunction of an NXP Semiconductors product can reasonably be expected to result in personal injury, death or severe property or environmental

damage. NXP Semiconductors accepts no liability for inclusion and/or use of NXP Semiconductors products in such equipment or applications and therefore such inclusion and/or use is at the customer's own risk.

Applications — Applications that are described herein for any of these products are for illustrative purposes only. NXP Semiconductors makes no representation or warranty that such applications will be suitable for the specified use without further testing or modification.

Limiting values — Stress above one or more limiting values (as defined in the Absolute Maximum Ratings System of IEC 60134) may cause permanent damage to the device. Limiting values are stress ratings only and operation of the device at these or any other conditions above those given in the Characteristics sections of this document is not implied. Exposure to limiting values for extended periods may affect device reliability.

Terms and conditions of sale — NXP Semiconductors products are sold subject to the general terms and conditions of commercial sale, as published at <http://www.nxp.com/profile/terms>, including those pertaining to warranty, intellectual property rights infringement and limitation of liability, unless explicitly otherwise agreed to in writing by NXP Semiconductors. In case of any inconsistency or conflict between information in this document and such terms and conditions, the latter will prevail.

No offer to sell or license — Nothing in this document may be interpreted or construed as an offer to sell products that is open for acceptance or the grant, conveyance or implication of any license under any copyrights, patents or other industrial or intellectual property rights.

Export control — This document as well as the item(s) described herein may be subject to export control regulations. Export might require a prior authorization from national authorities.

15.4 Trademarks

Notice: All referenced brands, product names, service names and trademarks are the property of their respective owners.

16. Contact information

For more information, please visit: <http://www.nxp.com>

For sales office addresses, please send an email to: salesaddresses@nxp.com

17. Contents

1	General description	1
2	Features	1
3	Ordering information	1
4	Functional diagram	2
5	Pinning information	3
5.1	Pinning	3
5.2	Pin description	3
6	Functional description	4
7	Limiting values	4
8	Recommended operating conditions	5
9	Static characteristics	5
10	Dynamic characteristics	7
11	Waveforms	9
12	Package outline	11
13	Abbreviations	14
14	Revision history	14
15	Legal information	15
15.1	Data sheet status	15
15.2	Definitions	15
15.3	Disclaimers	15
15.4	Trademarks	15
16	Contact information	15
17	Contents	16

Please be aware that important notices concerning this document and the product(s) described herein, have been included in section 'Legal information'.



© NXP B.V. 2009.

All rights reserved.

For more information, please visit: <http://www.nxp.com>

For sales office addresses, please send an email to: salesaddresses@nxp.com

Date of release: 12 August 2009

Document identifier: 74VHC_VHCT541_1