

Distributed by:

JAMECO[®]
ELECTRONICS

www.Jameco.com ♦ 1-800-831-4242

The content and copyrights of the attached
material are the property of its owner.

Jameco Part Number 1968507

4.20mm (.165") Pitch Mini-Fit Jr.™ Receptacle

5557
Single Row

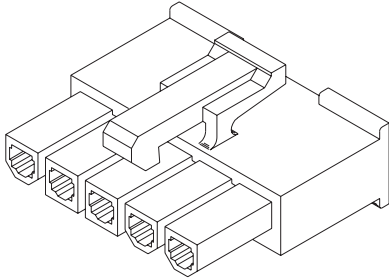

Circuits	Order No.	
	94V-2	94V-0
3*	39-01-4030	39-01-4031
4	39-01-4040	39-01-4041
5	39-01-4050	39-01-4051

*3-circuit receptacle designed for first-mate/last-break applications

Features and Benefits

- Low profile design to accommodate height constraints
- Fully isolated terminals to protect contacts from damage
- For wire-to-wire or wire-to-board applications

Reference Information

Packaging: Bag
 UL File No.: E29179
 CSA File No.: LR19980
 TUV License No.: R75142
 Mates With: 5559, 5566 and 5569 single row connectors
 Use With: 5556, 46083 or 45750 terminals
 Designed In: Millimeters

Mechanical

Contact Insertion Force: 1.5kg max.
 Contact Retention to Housing: 3.0kg min.

Physical

Housing: 6/6 nylon, UL 94V-2 or 94V-0
 Operating Temperature: -40 to +105°C

4.20mm (.165") Pitch Mini-Fit Jr.™ Plug

5559
Single Row, with and
Without Panel Mount Ears

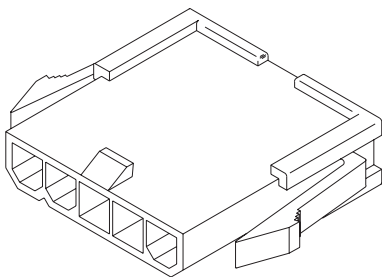

Features and Benefits

- Wire-to-wire plug for panel-mounted or free-hanging applications
- Available with and without panel mounting ears
- Positive housing locks to mate with Mini-Fit Jr. receptacle
- Fully isolated terminals to protect contacts from damage

Reference Information

Packaging: Bag
 UL File No.: E29179
 CSA File No.: LR19980
 TUV License No.: R75142
 Mates With: 5557 single row receptacle
 Use With: 5558, 30490, 46134 or 46012 terminals
 Panel Thickness: .079 to 2.00mm (.031 to 0.80")
 Designed In: Millimeters

Mechanical

Contact Insertion Force: 1.5kg max.
 Contact Retention to Housing: 3.0kg min.

Physical

Housing: 6/6 nylon, UL 94V-2 or 94V-0
 Operating Temperature: -40 to +105°C

Circuits	Order No.			
	Panel Mount		Free Hanging	
	94V-2	94V-0	94V-2	94V-0
3*	39-01-4032	39-01-4033	39-01-4036	39-01-4037
4	39-01-4042	39-01-4043	39-01-4046	39-01-4047
5	39-01-4052	39-01-4053	39-01-4056	39-01-4057

*3-circuit plug designed for first-mate/last-break applications

4.20mm (.165") Pitch Mini-Fit Jr.™ Header

5569 Right Angle, Single Row With Flanges

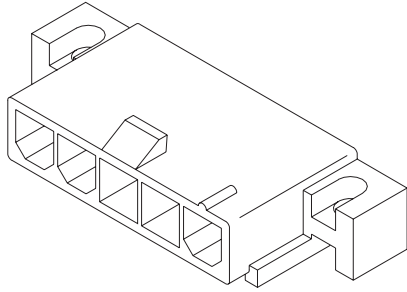

Features and Benefits

- Flanges allow for screw-in retention to board-mounted headers
- Low profile is ideal for power applications with space constraints

Reference Information

Packaging: Tray or bag
 UL File No.: E29179
 CSA File No.: LR19980
 TUV License No.: R75142
 Mates With: 5557 single row receptacle
 PCB Thickness: 1.60mm (.062")
 Process: Wave solder
 Designed In: Millimeters

Electrical

Voltage: 600V
 Current: (Used with 16 AWG)

Series	Circuits			
	2-3	4-6	7-10	12-24
46083	9.0A	8.0A	7.0A	6.0A
45750	12.0A	12.0A	12.0A	11.0A

Contact Resistance: 10 milliohms max.
 Dielectric Withstanding Voltage: 1500V AC
 Insulation Resistance: 1000 Megohms min.

Mechanical

Insertion Force to PCB: 5.0kg max.
 Durability: 30 cycles

Physical

Housing: 6/6 nylon, UL 94V-2 or 94V-0
 Contact: Brass
 Plating: Tin or Select Gold
 Underplating: Nickel
 Operating Temperature: -40 to +105°C

Circuits	Order No.				Lead-free
	Tin Plated		Select Gold Plated		
	94V-2	94V-0	94V-2	94V-0	
3	39-30-6039	39-30-7030	39-30-4037	39-30-4038	Yes
4	39-30-6049		50-30-4443		

4.20mm (.165") Pitch Mini-Fit Jr.™ Receptacle

5557 Dual Row

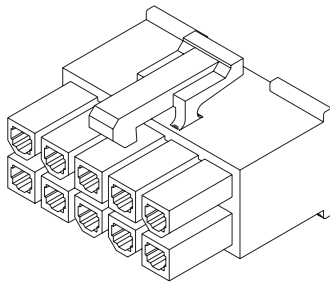

Features and Benefits

- Positive housing lock for secure mating retention
- Fully isolated terminals to protect contacts from damage
- Thumbblatch for easy unmating

Reference Information

Packaging: Bag
 UL File No.: E29179
 CSA File No.: LR19980
 TUV License No.: R75142
 Mates With: 5559, 5566, 5569, 42404, 42440, 42475, 43810, 43879 and 44068 dual row connectors
 Use With: 5556, 46083 or 45750 terminals
 Designed In: Millimeters

Electrical

Current: (Used with 16 AWG)

Series	Circuits			
	2-3	4-6	7-10	12-24
46083	9.0A	8.0A	7.0A	6.0A
45750	12.0A	12.0A	12.0A	11.0A

Mechanical

Contact Insertion Force: 1.5kg max.
 Contact Retention to Housing: 3.0kg min.

Physical

Housing: 6/6 nylon, UL 94V-2 or 94V-0
 Operating Temperature: -40 to +105°C

Circuits	Order No.		Circuits	Order No.	
	94V-2	94V-0		94V-2	94V-0
2	39-01-2020	39-01-2025	14	39-01-2140	39-01-2145
4	39-01-2040	39-01-2045	16	39-01-2160	39-01-2165
6	39-01-2060	39-01-2065	18	39-01-2180	39-01-2185
8	39-01-2080	39-01-2085	20	39-01-2200	39-01-2205
10	39-01-2100	39-01-2105	22	39-01-2220	39-01-2225
12	39-01-2120	39-01-2125	24	39-01-2240	39-01-2245



PRODUCT SPECIFICATION



LANGUAGE

JAPANESE
ENGLISH

【 1. 適用範囲 SCOPE 】

本仕様書は、_____ 殿 に納入する。

4. 2mm ピッチ プリント基板用 コネクタ _____ について規定する。

This specification covers the NEW MINI. FIT CONNECTOR series

【 2. 製品名称及び型番 PRODUCT NAME AND PART NUMBER 】

製品名称 Product Name		製品型番 Part Number
ターミナル (AWG #18~#24) Terminal (AWG #18~#24)	無鉛 LEAD FREE	5556GS7F
		5556GSL7F
ターミナル (AWG#22~#28) Terminal (AWG#22~#28)	無鉛 LEAD FREE	5556GS27F
		5556GS2L7F
ハウジング (UL 94V-2) Housing (UL 94V-2)	無鉛 LEAD FREE	5557-NR
ハウジング (UL 94V-0) Housing (UL 94V-0)	無鉛 LEAD FREE	5557-NR-210
ヘッダー アッセンブリ (UL 94V-2) Header Assembly (UL 94V-2)	無鉛 LEAD FREE	5566-NAGS
ヘッダー アッセンブリ (UL 94V-0) Header Assembly (UL 94V-0)	無鉛 LEAD FREE	5566-NAGS-210

N : 図面参照 Refer to the drawing.

REV.	A	A	A	A	A	A	A	A							
SHEET	1	2	3	4	5	6	7	8							
REVISE ON PC ONLY						TITLE:									
A	新規作成 RELEASED J2004-4752 '04/06/17 J.SASAMORI					NEW MINI FIT CONN. -LEAD FREE- 製品仕様書									
	THIS DOCUMENT CONTAINS INFORMATION THAT IS PROPRIETARY TO MOLEX INC. AND SHOULD NOT BE USED WITHOUT WRITTEN PERMISSION														
REV.	DESCRIPTION					WRITTEN BY:	CHECKED BY:	APPROVED BY:	DATE: YR/MO/DAY						
	DESIGN CONTROL J			STATUS		J.SASAMORI	K.TOJO	N.UKITA	2004/06/17						
DOCUMENT NUMBER PS-5557-043									FILE NAME PS5557043.doc	SHEET 1 OF 8					
EN-37-1(019)															



PRODUCT SPECIFICATION



LANGUAGE

JAPANESE
ENGLISH

【 3. 定格及び適用電線 RATINGS AND APPLICABLE WIRES 】

項目 Item	規格 Standard				
最大許容電圧 Rated Voltage (MAX.)	600 V				
最大許容電流 及び適用電線 Rated Current (MAX.) and Applicable wires	極数	2	4,6	8,10	12-24
	AWG#18	9 A	8 A	7 A	6 A
	AWG#20	7 A	6 A	5 A	5 A
	AWG#22	5 A	4 A	4 A	4 A
	AWG#24	4 A	3 A	3 A	3 A
	AWG#26	3 A	2 A	2 A	2 A
AWG#28	2 A	1 A	1 A	1 A	
使用温度範囲 Ambient Temperature Range	-40 °C ~ +105 °C *1				

[AC (実効値 rms) / DC]
被覆外径 Insulation O.D. :
5556GS7F, GSL7F :
φ 1.3~3.1mm
5556GS27F, GS2L7F :
φ 0.9~1.8mm

*1: 通電による温度上昇分も含む。

Including terminal temperature rise.

【 4. 性能 PERFORMANCE 】

4-1. 電気的性能 Electrical Performance

項目 Item	条件 Test Condition	規格 Requirement
4-1-1 接触抵抗 Contact Resistance	コネクタを嵌合させ、開放電圧 20mV 以下、短絡電流 10mA にて測定する。 (JIS C5402 5.4) Mate connectors, measure by dry circuit, 20mV MAX. , 10mA. (JIS C5402 5.4)	10 milliohm MAX.
4-1-2 絶縁抵抗 Insulation Resistance	コネクタを嵌合させ、隣接するターミナル間及びターミナル、アース間に、DC 500V を印加し測定する。 (JIS C5402 5.2/MIL-STD-202 試験法 302) Mate connectors, apply 500V DC between adjacent terminal or ground. (JIS C5402 5.2/MIL-STD-202 Method 302)	1000 Megohm MIN.

REVISE ON PC ONLY

TITLE:

A

SEE SHEET 1 OF 8

NEW MINI FIT CONN.

-LEAD FREE-

製品仕様書

REV.

DESCRIPTION

THIS DOCUMENT CONTAINS INFORMATION THAT IS PROPRIETARY TO MOLEX INC. AND SHOULD NOT BE USED WITHOUT WRITTEN PERMISSION

DOCUMENT NUMBER

PS-5557-043

FILE NAME

PS5557043.doc

SHEET

2 OF 8

EN-37-1(019)



PRODUCT SPECIFICATION



LANGUAGE

JAPANESE
ENGLISH

項目 Item	条件 Test Condition	規格 Requirement
4-1-3 耐電圧 Dielectric Strength	コネクタを嵌合させ、隣接するターミナル間及びターミナル、アース間に、AC 1500V (実効値)を1分間 印加する。 (JIS C5402 5.1/MIL-STD-202 試験法 301) Mate connectors, apply 1500V AC(rms) for 1 minute between adjacent terminal or ground. (JIS C5402 5.1/MIL-STD-202 Method 301)	異状なきこと No Breakdown
4-1-4 圧着部接触抵抗 Contact Resistance on Crimped Portion	ターミナルに適合電線を圧着し、開放電圧 20mV 以下、短絡電流 10mA にて測定する。 Crimp the applicable wire on to the terminal, measure by dry circuit, 20mV MAX., 10mA.	5 milliohm MAX.

4-2. 機械的性能 Mechanical Performance

項目 Item	条件 Test Condition	規格 Requirement
4-2-1 挿入力及び抜去力 Insertion / Withdrawal Force	毎分 25±3mm の速さで挿入、抜去を行う。 Insert and withdraw connectors at the speed rate of 25±3mm/minute.	第6項参照 Refer to paragraph 6
4-2-2 圧着部引張り強度 Crimping Pull Out Force	圧着されたターミナルを治具に固定し、電線を軸方向に 毎分 25±3mm の速さで引張る。 (JIS C5402 6.8) Fix the crimped terminal, apply axial pull out force on the wire at the speed rate of 25±3mm/minute. (JIS C5402 6.8)	AWG.#18 88.3 N {9.0kgf} MIN.
		AWG.#20 58.9 N {6.0kgf} MIN.
		AWG.#22 39.3 N {4.0kgf} MIN.
		AWG.#24 29.5 N {3.0kgf} MIN.
		AWG.#26 19.7 N {2.0kgf} MIN.
		AWG.#28 9.9 N {1.0kgf} MIN.
4-2-3 ターミナル挿入力 Terminal Insertion Force	圧着されたターミナルをハウジングに挿入する。 Insert the crimped terminal into the housing.	14.7 N { 1.5 kgf } MAX.

REVISE ON PC ONLY

TITLE:

A

SEE SHEET 1 OF 8

NEW MINI FIT CONN.

-LEAD FREE-

製品仕様書

REV.

DESCRIPTION

THIS DOCUMENT CONTAINS INFORMATION THAT IS PROPRIETARY TO MOLEX INC. AND SHOULD NOT BE USED WITHOUT WRITTEN PERMISSION

DOCUMENT NUMBER

PS-5557-043

FILE NAME

PS5557043.doc

SHEET

3 OF 8

EN-37-1(019)



PRODUCT SPECIFICATION



LANGUAGE

JAPANESE
ENGLISH

項目 Item	条件 Test Condition	規格 Requirement
4-2-4 ターミナル保持力 Terminal / Housing Retention Force	圧着されたターミナルをハウジングに装着し、電線を軸方向に 毎分 25±3mm の速さで引張る。 Apply axial pull out force at the speed rate of 25±3 mm/minute on the terminal assembled in the housing.	29.5 N { 3.0 kgf } MIN.
4-2-5 ピン保持力 Pin Retention Force	毎分 25±3mm の速さでピンを軸方向に押す。 Apply axial push force at the speed rate of 25±3 mm/minute.	9.9 N { 1.0 kgf } MIN.

4-3. その他 Environmental Performance and Others

項目 Item	条件 Test Condition	規格 Requirement	
4-3-1 繰り返し挿抜 Repeated Insertion / Withdrawal	1分間 10回以下 の速さで挿入、抜去を 30回繰り返す。 When mated up to 30 cycles repeatedly by the rate of 10 cycles/minute.	接触抵抗 Contact Resistance	20 milliohm MAX.
4-3-2 温度上昇 Temperature Rise	コネクタを嵌合させ、最大許容電流を通電し、コネクタの温度上昇分を測定する。 (UL 498) Carrying rated current load. (UL 498)	温度上昇 Temperature Rise	30°C MAX.
4-3-3 耐振動性 Vibration	DC 1mA 通電状態にて、嵌合軸を含む互いに垂直な 3方向 に掃引割合 10~55~10Hz/分、全振幅 1.5mm の振動を 各2時間 加える。 (MIL-STD-202 試験法 201) Amplitude: 1.5 mm P-P Sweep time: 10-55-10 Hz in 1 minute Duration: 2 hours in each X.Y.Z. axes (MIL STD-202 Method 201)	外 観 Appearance	異常なきこと No Damage
		接触抵抗 Contact Resistance	20 milliohm MAX.
		瞬断 Discontinuity	1.0 microsec. MAX.
4-3-4 耐衝撃性 Shock	DC 1mA 通電状態にて、嵌合軸を含む互いに垂直な 6方向 に、490m/s ² { 50G } の衝撃を 各3回 加える。 (JIS C0041/MIL-STD-202 試験法 213) 490m/s ² { 50G }, 3 strokes in each X.Y.Z. axes. (JIS C0041/MIL-STD-202 Method 213)	外 観 Appearance	異常なきこと No Damage
		接触抵抗 Contact Resistance	20 milliohm MAX.
		瞬断 Discontinuity	1.0 microsec. MAX.

REVISE ON PC ONLY

TITLE:

A

SEE SHEET 1 OF 8

NEW MINI FIT CONN.

-LEAD FREE-

製品仕様書

REV.

DESCRIPTION

THIS DOCUMENT CONTAINS INFORMATION THAT IS PROPRIETARY TO MOLEX INC. AND SHOULD NOT BE USED WITHOUT WRITTEN PERMISSION

DOCUMENT NUMBER

PS-5557-043

FILE NAME

PS5557043.doc

SHEET

4 OF 8

EN-37-1(019)



PRODUCT SPECIFICATION



LANGUAGE

JAPANESE
ENGLISH

項 目 Item		条 件 Test Condition	規 格 Requirement	
4-3-5	耐熱性 Heat Resistance	コネクタを嵌合させ、105±2°C の雰囲気中に 96時間 放置後取り出し、1~2時間 室温に放置する。 (JIS C0021/MIL-STD-202 試験法 108) 105±2°C, 96 hours (JIS C0021/MIL-STD-202 Method 108)	外 観 Appearance	異常なきこと No Damage
			接触抵抗 Contact Resistance	20 milliohm MAX.
4-3-6	耐寒性 Cold Resistance	コネクタを嵌合させ、-40±3°C の雰囲気中に 96時間 放置後取り出し、1~2時間 室温に放置する。 (JIS C0020) -40±3°C, 96 hours (JIS C0020)	外 観 Appearance	異常なきこと No Damage
			接触抵抗 Contact Resistance	20 milliohm MAX.
4-3-7	耐湿性 Humidity	コネクタを嵌合させ、60±2°C、相対湿度 90~95% の雰囲気中に 96時間 放置後取り出し、1~2時間 室温に放置する。 (JIS C0022/MIL-STD-202 試験法103) Temperature : 60±2°C Relative Humidity : 90 to 95% Duration : 96 hours (JIS C0022/MIL-STD-202 Method 103)	外 観 Appearance	異常なきこと No Damage
			接触抵抗 Contact Resistance	20 milliohm MAX.
			耐 電 圧 Dielectric Strength	4-1-3項 満足こと Must meet 4-1-3
			絶縁抵抗 Insulation Resistance	100 Megohm MIN.
4-3-8	温度サイクル Temperature Cycling	コネクタを嵌合させ、-55°C に 30分、+105°C に 30分、これを 1サイクル とし、5サイクル 繰り返す。但し、温度移行時間は、5分以内 とする。試験後 1~2時間 室温に放置する。(JIS C0025) 5 cycles of : a) -55°C 30 minutes b) +105°C 30 minutes (JIS C0025)	外 観 Appearance	異常なきこと No Damage
			接触抵抗 Contact Resistance	20 milliohm MAX.

REVISE ON PC ONLY

TITLE:

A

SEE SHEET 1 OF 8

NEW MINI FIT CONN.

-LEAD FREE-

製品仕様書

REV.

DESCRIPTION

THIS DOCUMENT CONTAINS INFORMATION THAT IS PROPRIETARY TO MOLEX INC. AND SHOULD NOT BE USED WITHOUT WRITTEN PERMISSION

DOCUMENT NUMBER

PS-5557-043

FILE NAME

PS5557043.doc

SHEET

5 OF 8

EN-37-1(019)



PRODUCT SPECIFICATION



LANGUAGE

JAPANESE
ENGLISH

項 目 Item		条 件 Test Condition	規 格 Requirement	
4-3-9	塩水噴霧 Salt Spray	コネクタを嵌合させ、35±2℃にて、重量比5±1%の塩水を48±4時間噴霧し、試験後常温で水洗いした後、室温で乾燥させる。 (JIS C0023/MIL-STD-202 試験法 101) 48±4 hours exposure to a salt spray from the 5±1% solution at 35±2℃. (JIS C0023/MIL-STD-202 Method 101)	外 観 Appearance	異常なきこと No Damage
			接触抵抗 Contact Resistance	20 milliohm MAX.
4-3-10	亜硫酸ガス SO ₂ Gas	コネクタを嵌合させ、40±2℃にて50±5ppmの亜硫酸ガス中に24時間放置する。 24 hours exposure to 50±5ppm. SO ₂ gas at 40±2℃.	外 観 Appearance	異常なきこと No Damage
			接触抵抗 Contact Resistance	20 milliohm MAX.
4-3-11	半田付け性 Solder Ability	ターミナルまたはピンをフラックスに浸し、本体の取付け基準面より1.2mm迄、245±3℃の半田に3±0.5秒浸す。 Solder Time : 3±0.5 seconds. Solder Temperature : 245±3℃	濡れ性 Solder Wetting	浸漬面積の75%以上 75% of immersed area must show no voids, pin holes.
4-3-12	半田耐熱性 Resistance to Soldering Heat	ターミナルまたはピンを本体の取付け基準面より1.2mm迄、260±5℃の半田に最大5秒浸す。 Solder Time : 5 5sec. MAX . Solder Temperature : 260±5℃	外 観 Appearance	端子ガタ割れ等 異常なきこと No Damage

() : 参考規格 Reference Standard

{ } : 参考単位 Reference Unit

【 5. 外観形状、寸法及び材質 PRODUCT SHAPE, DIMENSIONS AND MATERIALS 】

図面参照 Refer to the drawing.

REVISE ON PC ONLY		TITLE:	
A	SEE SHEET 1 OF 8	NEW MINI FIT CONN. -LEAD FREE- 製品仕様書	
	REV.	DESCRIPTION	THIS DOCUMENT CONTAINS INFORMATION THAT IS PROPRIETARY TO MOLEX INC. AND SHOULD NOT BE USED WITHOUT WRITTEN PERMISSION
DOCUMENT NUMBER PS-5557-043		FILE NAME PS5557043.doc	SHEET 6 OF 8



PRODUCT SPECIFICATION



LANGUAGE

JAPANESE
ENGLISH

【 6. 挿入力及び抜去力 INSERTION / WITHDRAWAL FORCE 】

極数 No. of CKT.	単位 Unit	挿入力 (最大値) Insertion Force (MAX.)			抜去力 (最小値) Withdrawal Force (MIN.)		
		初回 1st	6回目 6th	30回目 30th	初回 1st	6回目 6th	30回目 30th
2	N {kgf}	8.8 {0.9}	7.8 {0.8}	7.8 {0.8}	0.7 {0.07}	0.7 {0.07}	0.7 {0.07}
4	N {kgf}	17.6 {1.8}	15.6 {1.6}	15.6 {1.6}	1.4 {0.14}	1.4 {0.14}	1.4 {0.14}
6	N {kgf}	26.4 {2.7}	23.5 {2.4}	23.5 {2.4}	2.1 {0.21}	2.1 {0.21}	2.1 {0.21}
8	N {kgf}	35.3 {3.6}	31.3 {3.2}	31.3 {3.2}	2.8 {0.28}	2.8 {0.28}	2.8 {0.28}
10	N {kgf}	44.1 {4.5}	39.2 {4.0}	39.2 {4.0}	3.5 {0.35}	3.5 {0.35}	3.5 {0.35}
12	N {kgf}	52.9 {5.4}	47.0 {4.8}	47.0 {4.8}	4.2 {0.42}	4.2 {0.42}	4.2 {0.42}
14	N {kgf}	61.8 {6.3}	54.9 {5.6}	54.9 {5.6}	4.8 {0.49}	4.8 {0.49}	4.8 {0.49}
16	N {kgf}	70.6 {7.2}	62.7 {6.4}	62.7 {6.4}	5.5 {0.56}	5.5 {0.56}	5.5 {0.56}
18	N {kgf}	79.4 {8.1}	70.6 {7.2}	70.6 {7.2}	6.2 {0.63}	6.2 {0.63}	6.2 {0.63}
20	N {kgf}	88.2 {9.0}	78.4 {8.0}	78.4 {8.0}	6.9 {0.70}	6.9 {0.70}	6.9 {0.70}
22	N {kgf}	97.1 {9.9}	86.3 {8.8}	86.3 {8.8}	7.6 {0.77}	7.6 {0.77}	7.6 {0.77}
24	N {kgf}	105.9 {10.8}	94.1 {9.6}	94.1 {9.6}	8.3 {0.84}	8.3 {0.84}	8.3 {0.84}

REVISE ON PC ONLY		TITLE:	
A	SEE SHEET 1 OF 8	NEW MINI FIT CONN.	
		-LEAD FREE- 製品仕様書	
REV.	DESCRIPTION	THIS DOCUMENT CONTAINS INFORMATION THAT IS PROPRIETARY TO MOLEX INC. AND SHOULD NOT BE USED WITHOUT WRITTEN PERMISSION	
DOCUMENT NUMBER PS-5557-043		FILE NAME PS5557043.doc	SHEET 7 OF 8

10 9 8 7 6 5 4 3 2 1

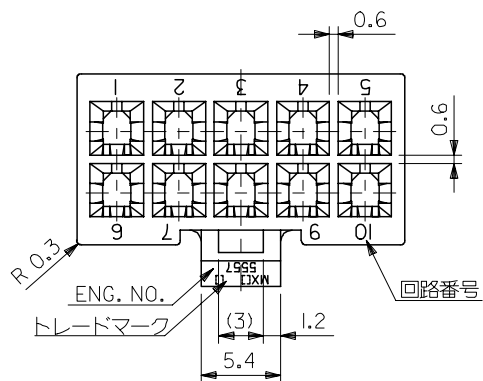

- 注記
- 適用ターミナル：5556 シリーズ
 - 嵌合相手：5559 シリーズ
5566 シリーズ
5569 シリーズ
501566 シリーズ
- △ D 面の位置にて維持すること。

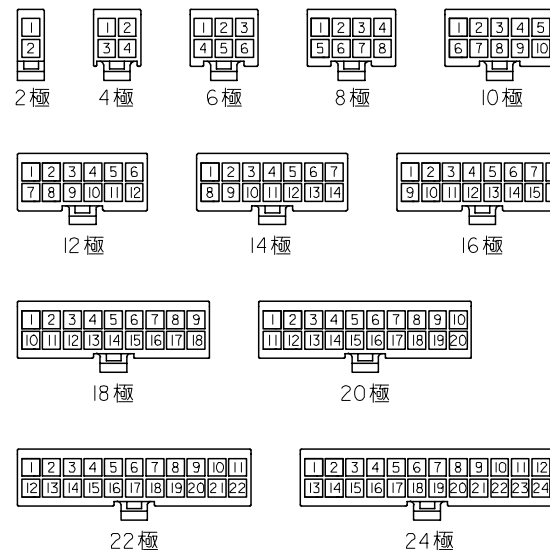

回路レイアウト図
(SCALE 1:1)

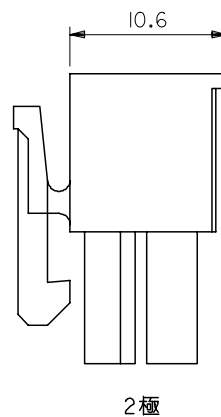
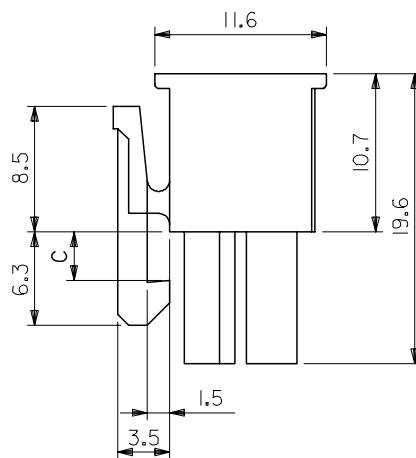
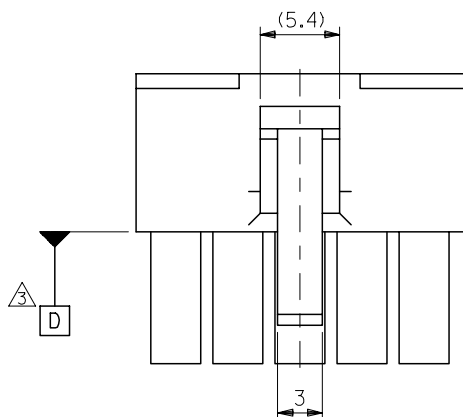

材料 MATERIAL	66ナイロン (UL94V-2)
仕上げ FINISH	—
適用電線範囲 WIRE RANGE	—
被覆外径 INS. RANGE	—

C	B	A	EDP. NO.	ENG. NO.	極数
3.6	51.6	46.2	39-01-2240	5557-24R	24
	47.4	42	-2220	-22R	22
	43.2	37.8	-2200	-20R	20
3.3	39	33.6	-2180	-18R	18
	34.8	29.4	-2160	-16R	16
	30.6	25.2	-2140	-14R	14
	26.4	21	-2120	-12R	12
	22.2	16.8	-2100	-10R	10
	18	12.6	-2080	-08R	8
	13.8	8.4	-2060	-06R	6
	9.6	4.2	-2040	-04R	4
	5.4	—	39-01-2020	5557-02R	2

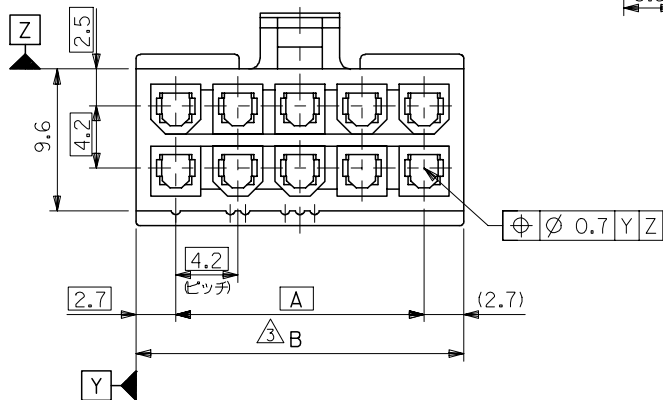

REVISED EC NO: J2005-3799 DRWN: NABE CHKD: TOYODA APPR: NUKITA	DESCRIPTION	GENERAL TOLERANCES (UNLESS SPECIFIED)	DIMENSION STYLE MM ONLY	SCALE ---	DESIGN UNITS METRIC	THIRD ANGLE PROJECTION
	REV	10 UNDER ±0.2	DRAWN BY DATE S. MOCHIZUKI '90/02/22	TITLE NEW MINI FIT CONN REC. HOUSING	MOLEX INCORPORATED	
	J	10 OVER 30 UNDER ±0.3	CHECKED BY DATE M. FUKUSHIMA '97/01/08	APPROVED BY DATE M. FUKUSHIMA '97/01/08		
		30 OVER ±0.4	ANGULAR ±3 °	MATERIAL NO. SEE CHART	DOCUMENT NO. SD-5557-003	SHEET NO. 1 OF 2
		DRAFT WHERE APPLICABLE MUST REMAIN WITHIN DIMENSIONS	SIZE A3	THIS DRAWING CONTAINS INFORMATION THAT IS PROPRIETARY TO MOLEX INCORPORATED AND SHOULD NOT BE USED WITHOUT WRITTEN PERMISSION		

