

Distributed by:

**JAMECO**<sup>®</sup>  
ELECTRONICS

**www.Jameco.com ♦ 1-800-831-4242**

The content and copyrights of the attached  
material are the property of its owner.

Jameco Part Number 909847

## FFB2222A

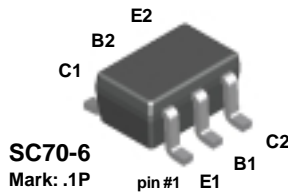

**SC70-6**  
Mark: .1P

NOTE: The pinouts are symmetrical; pin 1 and pin 4 are interchangeable. Units inside the carrier can be of either orientation and will not affect the functionality of the device.

## FMB2222A

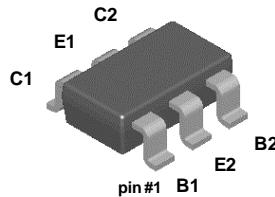

**SuperSOT™-6**  
Mark: .1P  
Dot denotes pin #1

## MMPQ2222A

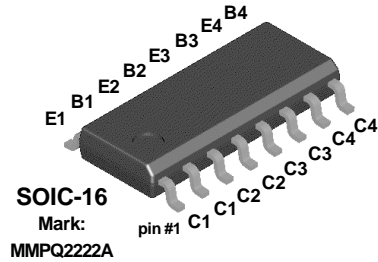

**SOIC-16**  
Mark: MMPQ2222A

## NPN Multi-Chip General Purpose Amplifier

This device is for use as a medium power amplifier and switch requiring collector currents up to 500 mA. Sourced from Process 19.

### Absolute Maximum Ratings\*

$T_A = 25^\circ\text{C}$  unless otherwise noted

Symbol	Parameter	Value	Units
$V_{CEO}$	Collector-Emitter Voltage	40	V
$V_{CBO}$	Collector-Base Voltage	75	V
$V_{EBO}$	Emitter-Base Voltage	5.0	V
$I_C$	Collector Current - Continuous	500	mA
$T_J, T_{stg}$	Operating and Storage Junction Temperature Range	-55 to +150	$^\circ\text{C}$

\*These ratings are limiting values above which the serviceability of any semiconductor device may be impaired.

#### NOTES:

- 1) These ratings are based on a maximum junction temperature of 150 degrees C.
- 2) These are steady state limits. The factory should be consulted on applications involving pulsed or low duty cycle operations.

### Thermal Characteristics

$T_A = 25^\circ\text{C}$  unless otherwise noted

Symbol	Characteristic	Max			Units
		FFB2222A	FMB2222A	MMPQ2222A	
$P_D$	Total Device Dissipation	300	700	1,000	mW
	Derate above $25^\circ\text{C}$	2.4	5.6	8.0	mW/ $^\circ\text{C}$
$R_{\theta JA}$	Thermal Resistance, Junction to Ambient	415	180		$^\circ\text{C}/\text{W}$
	Effective 4 Die			125	$^\circ\text{C}/\text{W}$
	Each Die			240	$^\circ\text{C}/\text{W}$

## NPN Multi-Chip General Purpose Amplifier

(continued)

### Electrical Characteristics

$T_A = 25^\circ\text{C}$  unless otherwise noted

Symbol	Parameter	Test Conditions	Min	Typ	Max	Units
<b>OFF CHARACTERISTICS</b>						
$V_{(BR)CEO}$	Collector-Emitter Breakdown Voltage*	$I_C = 10\text{ mA}, I_B = 0$	40			V
$V_{(BR)CBO}$	Collector-Base Breakdown Voltage	$I_C = 10\ \mu\text{A}, I_E = 0$	75			V
$V_{(BR)EBO}$	Emitter-Base Breakdown Voltage	$I_E = 10\ \mu\text{A}, I_C = 0$	5.0			V
$I_{CBO}$	Collector Cutoff Current	$V_{CB} = 60\text{ V}, I_E = 0$			10	nA
$I_{EBO}$	Emitter Cutoff Current	$V_{EB} = 3.0\text{ V}, I_C = 0$			10	nA

### ON CHARACTERISTICS

$h_{FE}$	DC Current Gain	$I_C = 0.1\text{ mA}, V_{CE} = 10\text{ V}$ $I_C = 1.0\text{ mA}, V_{CE} = 10\text{ V}$ $I_C = 10\text{ mA}, V_{CE} = 10\text{ V}$ $I_C = 150\text{ mA}, V_{CE} = 10\text{ V}^*$ $I_C = 150\text{ mA}, V_{CE} = 1.0\text{ V}^*$ $I_C = 500\text{ mA}, V_{CE} = 10\text{ V}^*$	35 50 75 100 50 40		300	
$V_{CE(sat)}$	Collector-Emitter Saturation Voltage*	$I_C = 150\text{ mA}, I_B = 15\text{ mA}$ $I_C = 500\text{ mA}, I_B = 50\text{ mA}$			0.3 1.0	V V
$V_{BE(sat)}$	Base-Emitter Saturation Voltage*	$I_C = 150\text{ mA}, I_B = 15\text{ mA}$ $I_C = 500\text{ mA}, I_B = 50\text{ mA}$			1.2 2.0	V V

### SMALL SIGNAL CHARACTERISTICS

$f_T$	Current Gain - Bandwidth Product	$I_C = 20\text{ mA}, V_{CE} = 20\text{ V},$ $f = 100\text{ MHz}$		300		MHz
$C_{obo}$	Output Capacitance	$V_{CB} = 10\text{ V}, I_E = 0, f = 100\text{ kHz}$		4.0		pF
$C_{ibo}$	Input Capacitance	$V_{EB} = 0.5\text{ V}, I_C = 0, f = 100\text{ kHz}$		20		pF
NF	Noise Figure	$I_C = 100\ \mu\text{A}, V_{CE} = 10\text{ V},$ $R_S = 1.0\text{ k}\Omega, f = 1.0\text{ kHz}$		2.0		dB

### SWITCHING CHARACTERISTICS

$t_d$	Delay Time	$V_{CC} = 30\text{ V}, V_{BE(OFF)} = 0.5\text{ V},$		8		ns
$t_r$	Rise Time	$I_C = 150\text{ mA}, I_{B1} = 15\text{ mA}$		20		ns
$t_s$	Storage Time	$V_{CC} = 30\text{ V}, I_C = 150\text{ mA},$		180		ns
$t_f$	Fall Time	$I_{B1} = I_{B2} = 15\text{ mA}$		40		ns

\*Pulse Test: Pulse Width  $\leq 300\ \mu\text{s}$ , Duty Cycle  $\leq 2.0\%$

### Spice Model

NPN (Is=14.34f Xti=3 Eg=1.11 Vaf=74.03 Bf=255.9 Ne=1.307 Ise=14.34f Ikf=.2847 Xtb=1.5 Br=6.092 Nc=2 Isc=0 Ikr=0 Rc=1 Cjc=7.306p Mjc=.3416 Vjc=.75 Fc=.5 Cje=22.01p Mje=.377 Vje=.75 Tr=46.91n Tf=411.1p Itf=.6 Vtf=1.7 Xtf=3 Rb=10)

FFB2222A / FMB2222A / MMPQ2222A

Typical Characteristics

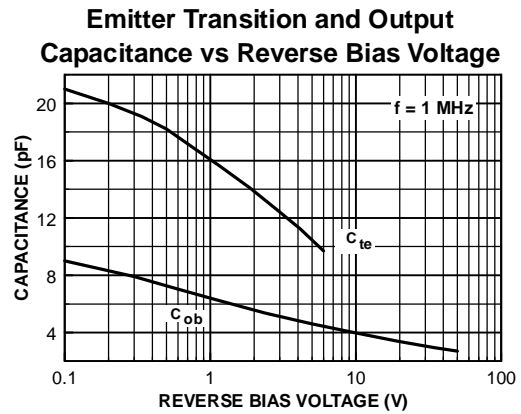
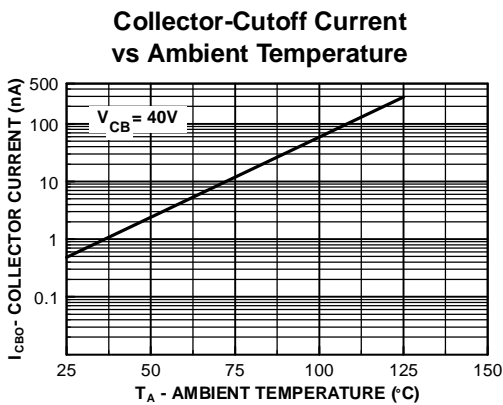
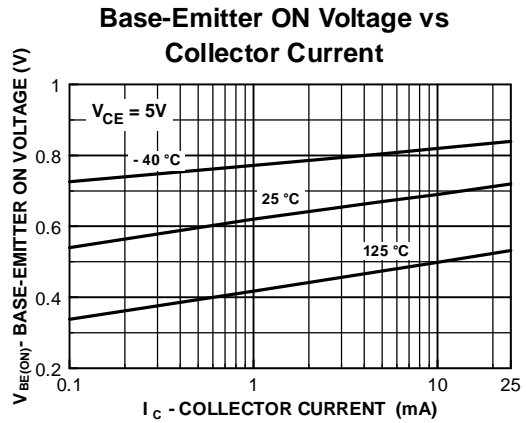
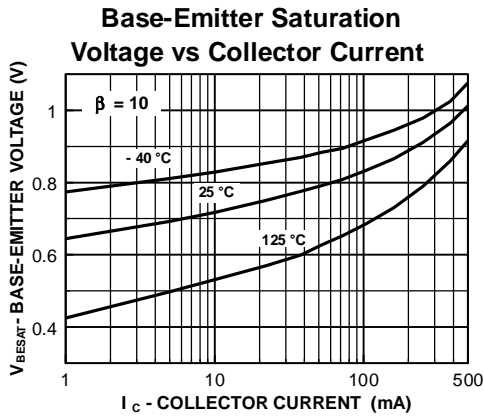
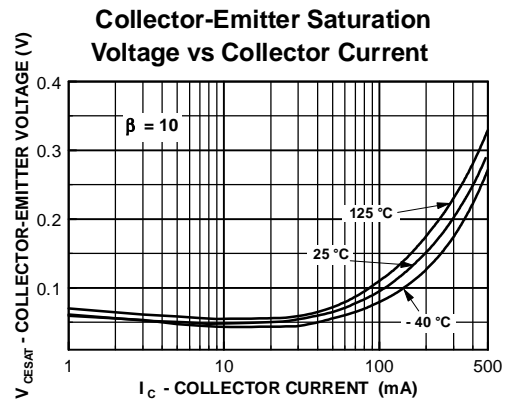
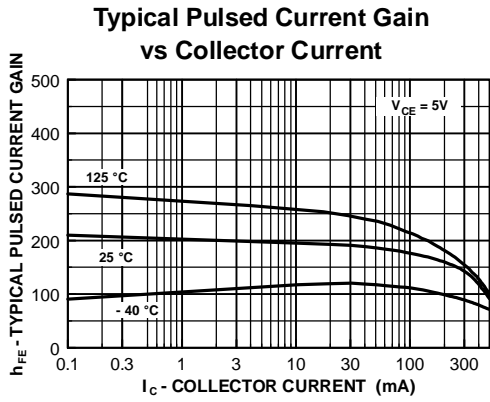

# NPN Multi-Chip General Purpose Amplifier

(continued)

FFB2222A / FMB2222A / MMFQ2222A

## Typical Characteristics (continued)

**Turn On and Turn Off Times vs Collector Current**

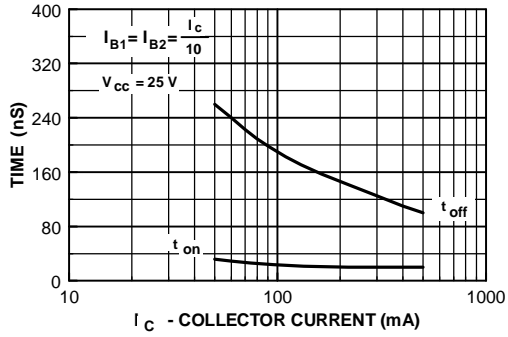

**Switching Times vs Collector Current**

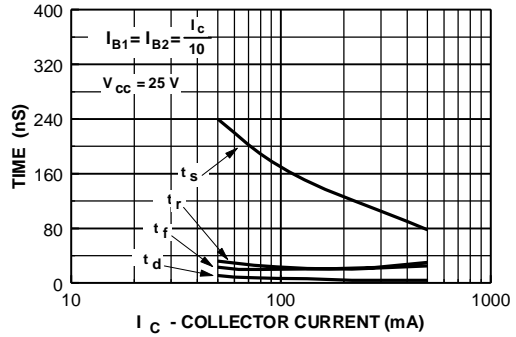

**Power Dissipation vs Ambient Temperature**

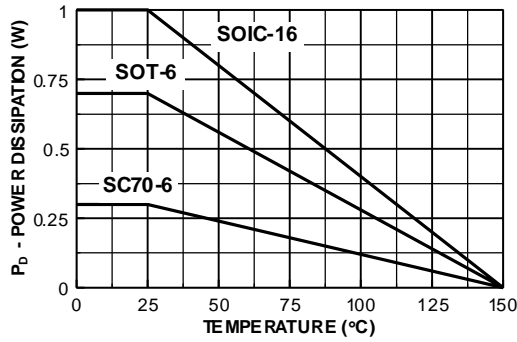

**NPN Multi-Chip General Purpose Amplifier**  
(continued)

**Typical Common Emitter Characteristics** (f = 1.0kHz)

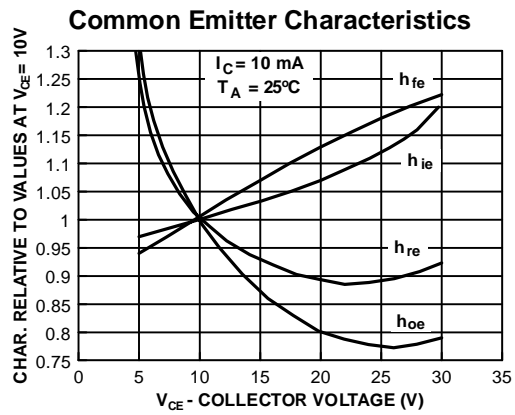
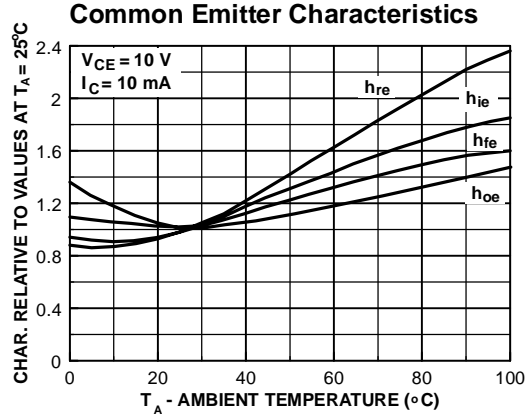
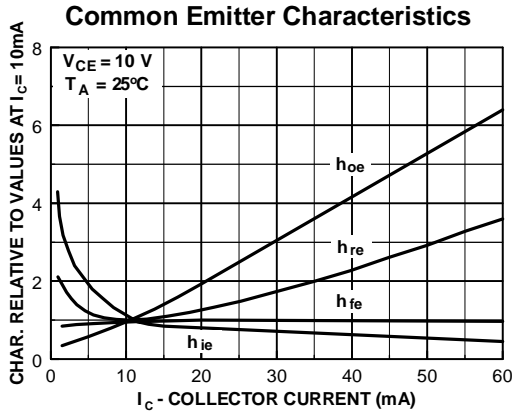

FFB2222A / FMB2222A / MMPQ2222A

Test Circuits

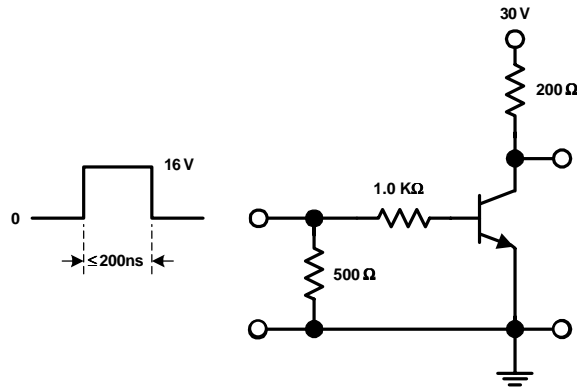

FIGURE 1: Saturated Turn-On Switching Time

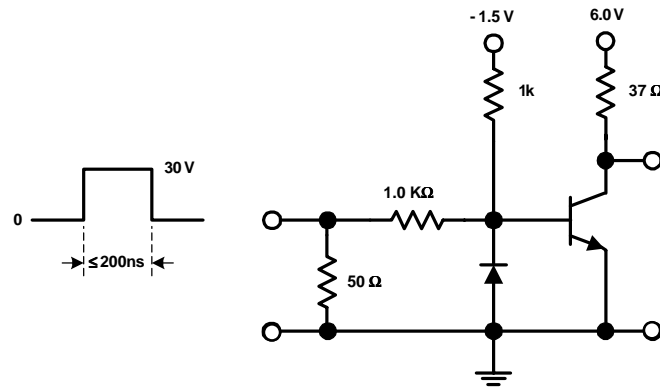

FIGURE 2: Saturated Turn-Off Switching Time

## TRADEMARKS

The following are registered and unregistered trademarks Fairchild Semiconductor owns or is authorized to use and is not intended to be an exhaustive list of all such trademarks.

ACEx™	FASTr™	PowerTrench®	SyncFET™
Bottomless™	GlobalOptoisolator™	QFET™	TinyLogic™
CoolFET™	GTO™	QS™	UHC™
CROSSVOLT™	HiSeC™	QT Optoelectronics™	VCX™
DOME™	ISOPLANAR™	Quiet Series™	
E <sup>2</sup> CMOS™	MICROWIRE™	SILENT SWITCHER®	
EnSigna™	OPTOLOGIC™	SMART START™	
FACT™	OPTOPLANAR™	SuperSOT™-3	
FACT Quiet Series™	PACMAN™	SuperSOT™-6	
FAST®	POP™	SuperSOT™-8	

## DISCLAIMER

FAIRCHILD SEMICONDUCTOR RESERVES THE RIGHT TO MAKE CHANGES WITHOUT FURTHER NOTICE TO ANY PRODUCTS HEREIN TO IMPROVE RELIABILITY, FUNCTION OR DESIGN. FAIRCHILD DOES NOT ASSUME ANY LIABILITY ARISING OUT OF THE APPLICATION OR USE OF ANY PRODUCT OR CIRCUIT DESCRIBED HEREIN; NEITHER DOES IT CONVEY ANY LICENSE UNDER ITS PATENT RIGHTS, NOR THE RIGHTS OF OTHERS.

## LIFE SUPPORT POLICY

FAIRCHILD'S PRODUCTS ARE NOT AUTHORIZED FOR USE AS CRITICAL COMPONENTS IN LIFE SUPPORT DEVICES OR SYSTEMS WITHOUT THE EXPRESS WRITTEN APPROVAL OF FAIRCHILD SEMICONDUCTOR CORPORATION. As used herein:

1. Life support devices or systems are devices or systems which, (a) are intended for surgical implant into the body, or (b) support or sustain life, or (c) whose failure to perform when properly used in accordance with instructions for use provided in the labeling, can be reasonably expected to result in significant injury to the user.
2. A critical component is any component of a life support device or system whose failure to perform can be reasonably expected to cause the failure of the life support device or system, or to affect its safety or effectiveness.

## PRODUCT STATUS DEFINITIONS

### Definition of Terms

Datasheet Identification	Product Status	Definition
Advance Information	Formative or In Design	This datasheet contains the design specifications for product development. Specifications may change in any manner without notice.
Preliminary	First Production	This datasheet contains preliminary data, and supplementary data will be published at a later date. Fairchild Semiconductor reserves the right to make changes at any time without notice in order to improve design.
No Identification Needed	Full Production	This datasheet contains final specifications. Fairchild Semiconductor reserves the right to make changes at any time without notice in order to improve design.
Obsolete	Not In Production	This datasheet contains specifications on a product that has been discontinued by Fairchild semiconductor. The datasheet is printed for reference information only.