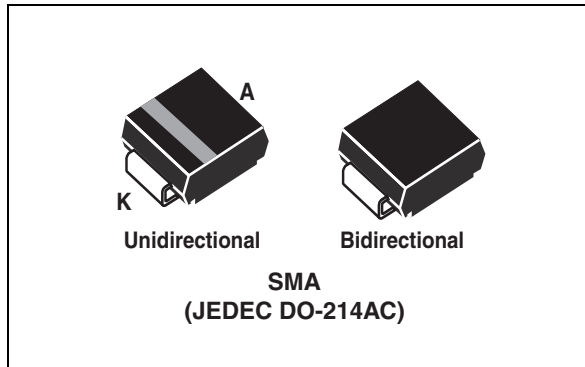

High junction temperature Transil™

Datasheet - production data

**Description**

The SMA6J Transil series has been designed to protect sensitive equipment against electro-static discharges according to IEC 61000-4-2, MIL STD 883 Method 3015, and electrical over stress such as IEC 61000-4-4 and 5. They are generally for surges below 600 W 10/1000 μ s.

This planar technology makes it compatible with high-end equipment and SMPS where low leakage current and high junction temperature are required to provide reliability and stability over time. Their low clamping voltages provides a better safety margin to protect sensitive circuits with extended life time expectancy.

Packaged in SMA, this minimizes PCB space consumption (SMA footprint in accordance with IPC 7531 standard).

Features

- Peak pulse power:
 - 600 W (10/1000 μ s)
 - 4 kW (8/20 μ s)
- Stand off voltage range: from 5 V to 188 V
- Unidirectional and bidirectional types
- Low clamping voltage versus standard series
- Low leakage current:
 - 0.2 μ A at 25 °C
 - 1 μ A at 85 °C
- Operating T_j max: 175 °C
- JEDEC registered package outline

Complies with the following standards

- IEC 61000-4-2 level 4:
 - 15 kV (air discharge)
 - 8 kV (contact discharge)
- MIL STD 883G-Method 3015-7: class3B
 - 25 kV (human body model)

TM: Transil is a trademark of STMicroelectronics

1 Characteristics

Table 1. Absolute ratings ($T_{amb} = 25\text{ }^{\circ}\text{C}$)

Symbol	Parameter		Value	Unit
P_{PP}	Peak pulse power dissipation ⁽¹⁾	T_j initial = T_{amb}	600	W
P	Power dissipation on infinite heatsink	$T_{amb} = 55\text{ }^{\circ}\text{C}$	4	W
I_{FSM}	Non repetitive surge peak forward current for unidirectional types	$t_p = 10\text{ ms}$ T_j initial = T_{amb}	60	A
T_{stg}	Storage temperature range		-65 to +175	$^{\circ}\text{C}$
T_j	Operating junction temperature range		-55 to +175	$^{\circ}\text{C}$
T_L	Maximum lead temperature for soldering during 10 s		260	$^{\circ}\text{C}$

1. For a surge greater than the maximum values, the diode will fail in short-circuit.

Table 2. Thermal resistances

Symbol	Parameter	Value	Unit
$R_{th(j-l)}$	Junction to leads	30	$^{\circ}\text{C/W}$
$R_{th(j-a)}$	Junction to ambient on printed circuit on recommended pad layout	120	$^{\circ}\text{C/W}$

Table 3. Electrical characteristics - definitions ($T_{amb} = 25\text{ }^{\circ}\text{C}$)

Symbol	Parameter	
V_{RM}	Stand-off voltage	
V_{BR}	Breakdown voltage	
V_{CL}	Clamping voltage	
I_{RM}	Leakage current @ V_{RM}	
I_{PP}	Peak pulse current	
α_T	Voltage temperature coefficient	
V_F	Forward voltage drop	
R_D	Dynamic resistance	

Table 4. Electrical characteristics - values ($T_{amb} = 25\text{ °C}$)

Type	$I_{RM} \text{ max}@V_{RM}$		$V_{BR} @I_R^{(1)}$				$V_{CL} @I_{PP}$ 10/1000 μs		$R_D^{(2)}$ 10/1000 μs	$V_{CL} @I_{PP}$ 8/20 μs		$R_D^{(2)}$ 8/20 μs	$\alpha T^{(3)}$	
	25 °C	85 °C	min	typ	max	max		max		max		max		
	μA	V	V		mA	V	A	Ω	V	A	Ω	10-4/°C		
SMA6J5.0A/CA	20	50	5.0	6.40	6.74	7.07	10	9.1	68	0.029	13.4	298	0.021	5.7
SMA6J6.0A/CA	20	50	6.0	6.70	7.05	7.41	10	9.5	61	0.034	13.7	290	0.022	5.9
SMA6J6.5A/CA	20	50	6.5	7.20	7.58	7.96	10	10.2	56	0.040	14.5	276	0.024	6.1
SMA6J8.5A/CA	20	50	8.5	9.4	9.9	10.4	1	13.3	41.7	0.070	18.7	205	0.041	7.3
SMA6J10A/CA	0.2	1	10	11.1	11.7	12.3	1	15.7	37	0.093	19.6	184	0.040	7.8
SMA6J12A/CA	0.2	1	12	13.3	14.0	14.7	1	18.8	31	0.133	23.5	157	0.056	8.3
SMA6J13A/CA	0.2	1	13	14.4	15.2	15.9	1	20.4	29	0.154	23.9	147	0.054	8.4
SMA6J15A/CA	0.2	1	15	16.7	17.6	18.5	1	23.6	25.1	0.206	27.7	123	0.075	8.8
SMA6J18A/CA	0.2	1	18	20.0	21.1	22.1	1	28.3	21.5	0.288	33.2	102	0.108	9.2
SMA6J20A/CA	0.2	1	20	22.2	23.4	24.5	1	31.4	19.4	0.354	36.8	93	0.132	9.4
SMA6J24A/CA	0.2	1	24	26.7	28.1	29.5	1	37.8	16	0.516	44.3	80	0.184	9.6
SMA6J26A/CA	0.2	1	26	28.9	30.4	31.9	1	40.9	14.9	0.600	47.9	75	0.213	9.7
SMA6J28A/CA	0.2	1	28	31.1	32.7	34.4	1	44.0	13.8	0.697	51.6	68	0.253	9.8
SMA6J33A/CA	0.2	1	33	36.7	38.6	40.6	1	51.9	11.8	0.963	60.8	57	0.356	10.0
SMA6J40A/CA	0.2	1	40	44.4	46.7	49.1	1	62.8	9.7	1.42	73.6	48	0.511	10.1
SMA6J48A/CA	0.2	1	48	53.3	56.1	58.9	1	75.4	8.1	2.04	88.4	40	0.736	10.3
SMA6J58A/CA	0.2	1	58	64.4	67.8	71.2	1	91.1	6.7	2.97	100	33	0.863	10.4
SMA6J70A/CA	0.2	1	70	77.8	81.9	86.0	1	110	5.5	4.38	120	27	1.27	10.5
SMA6J85A/CA	0.2	1	85	94	99	104	1	134	4.6	6.45	146	22.5	1.85	10.6
SMA6J100A/CA	0.2	1	100	111	117	123	1	157	3.8	9.03	172	19	2.58	10.7
SMA6J130A/CA	0.2	1	130	144	152	159	1	204	3	14.9	223	15	4.24	10.8
SMA6J154A/CA	0.2	1	154	171	180	189	1	242	2.4	22.1	265	12.6	6.00	10.8
SMA6J170A/CA	0.2	1	170	189	199	209	1	275	2.2	30.0	292	11.3	7.39	10.8
SMA6J188A/CA	0.2	1	188	209	220	231	1	328	2	48.5	323	10.3	8.97	10.8

1. Pulse test: $t_p < 50\text{ms}$.

2. To calculate maximum clamping voltage at other surge currents, use the following formula

$$V_{CLmax} = R_D \times I_{PP} + V_{BRmax}$$

3. To calculate V_{BR} versus junction temperature, use the following formula:

$$V_{BR} @ T_j = V_{BR} @ 25\text{ °C} \times (1 + \alpha T \times (T_j - 25))$$

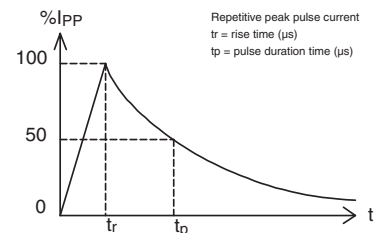

Figure 1. Peak power dissipation versus initial junction temperature

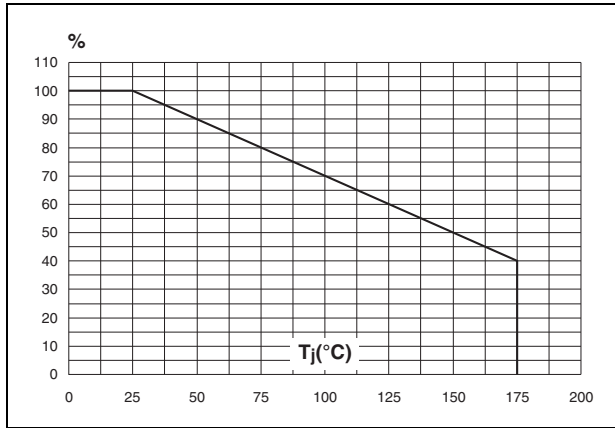

Figure 2. Peak pulse power versus exponential pulse duration (T_j initial = 25 °C)

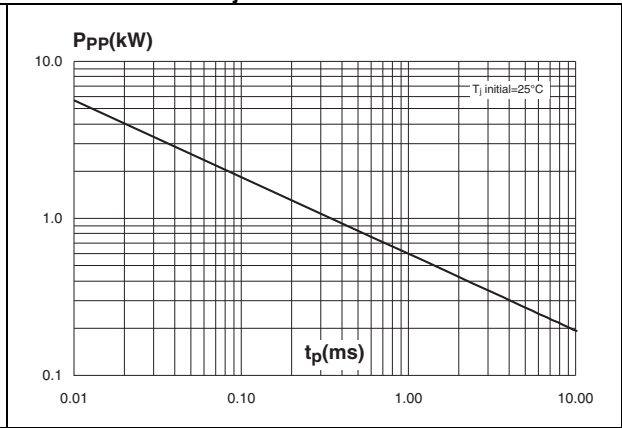

Figure 3. Clamping voltage versus peak pulse current (exponential waveform, maximum values)

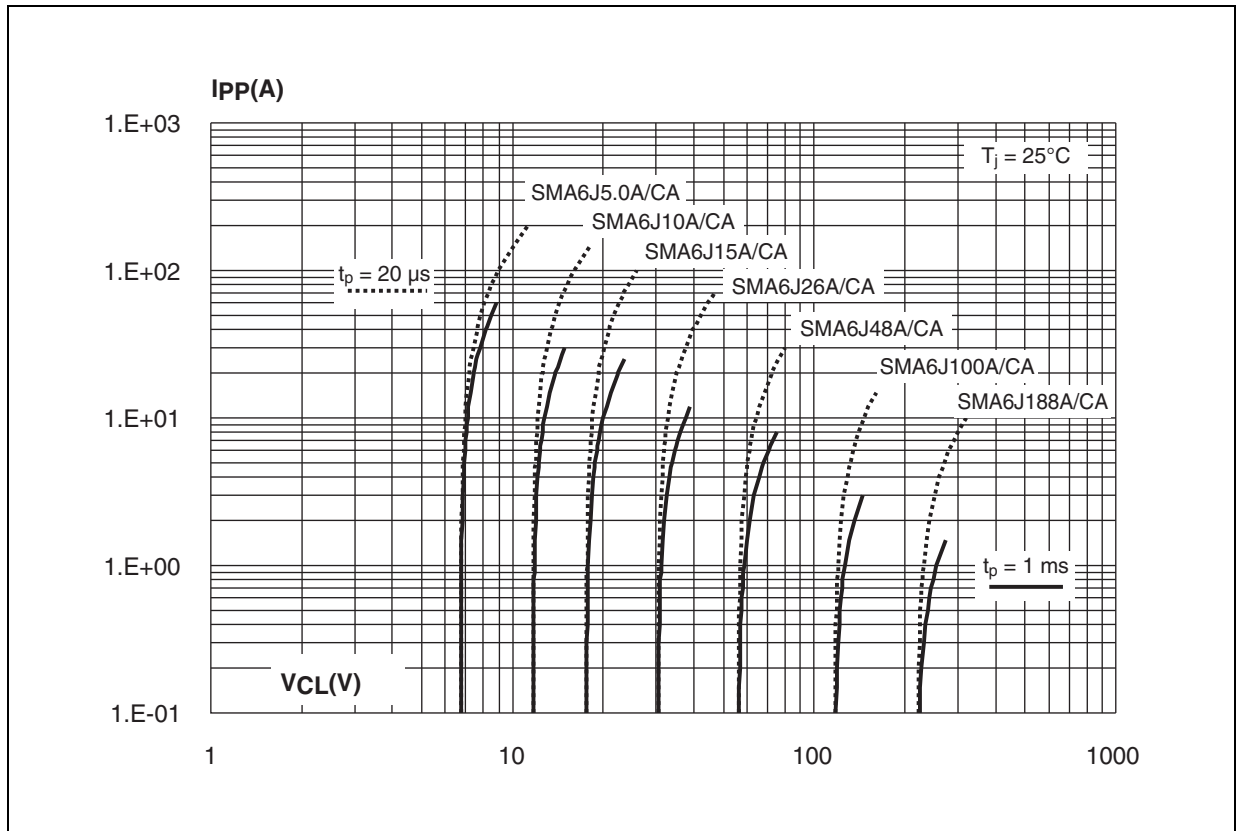

Figure 4. Junction capacitance versus reverse applied voltage (typical values) (SMA6JxxA)

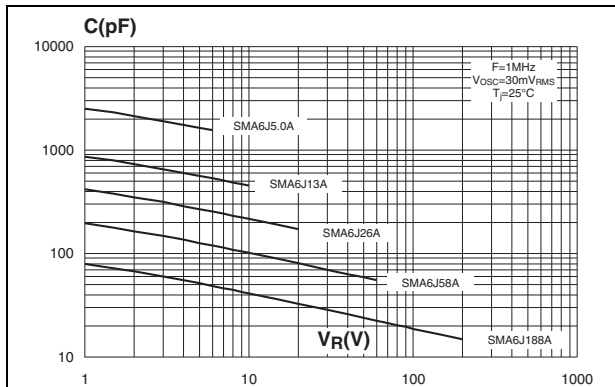

Figure 5. Junction capacitance versus reverse applied voltage (typical values) (SMA6JxxCA)

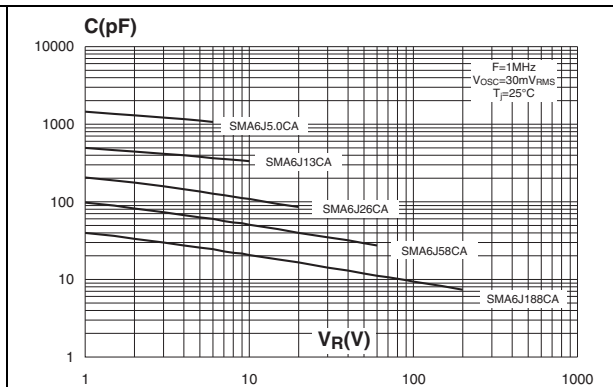

Figure 6. Peak forward voltage drop versus peak forward current (typical values)

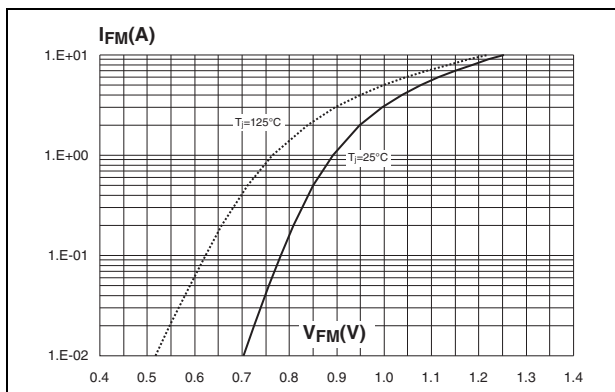

Figure 7. Relative variation of thermal impedance junction to ambient versus pulse duration (printed circuit board FR4, S_{Cu} = 1 cm²)

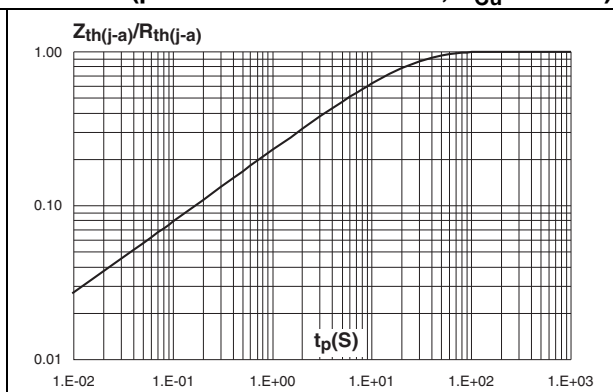

Figure 8. Thermal resistance junction to ambient versus copper surface under each lead (printed circuit board FR4, e_{Cu} = 35 μm)

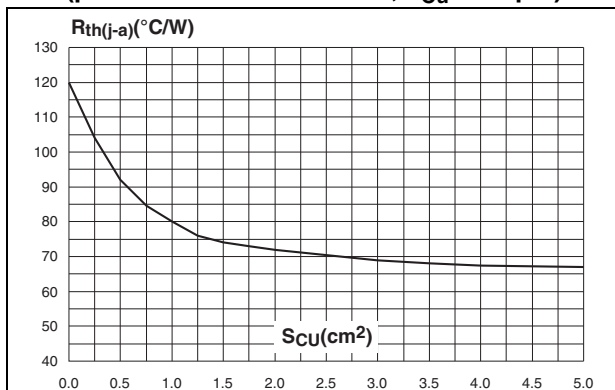
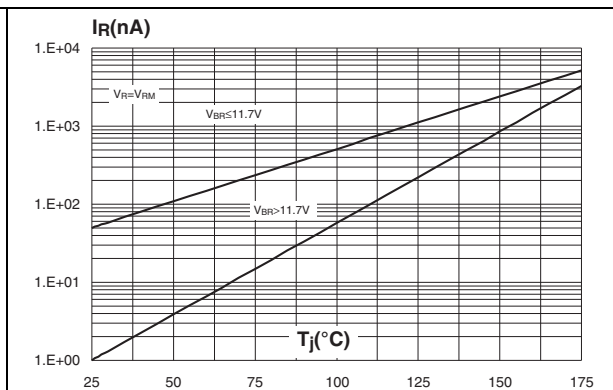
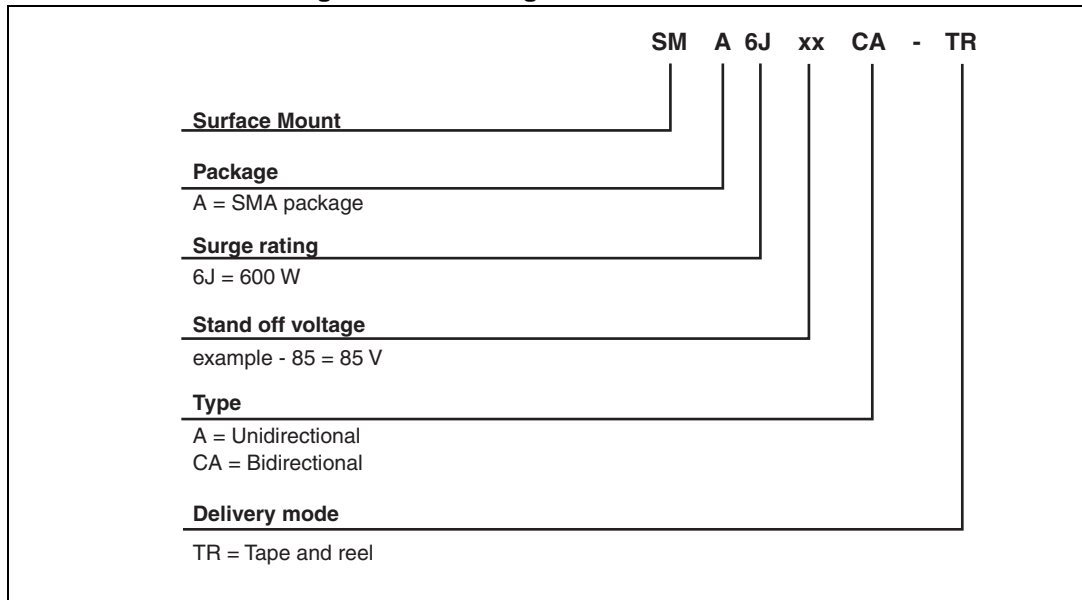

Figure 9. Leakage current versus junction temperature (typical values)



2 Ordering information scheme

Figure 10. Ordering information scheme



3 Package information

- Case: JEDEC DO-214AC molded plastic over Planar junction
- Terminals: Solder plated, solderable per MIL-STD-750, Method 2026
- Polarity: For unidirectional types the band indicates cathode.
- Flammability: Epoxy is rated UL94V-0
- RoHS package

In order to meet environmental requirements, ST offers these devices in ECOPACK® packages. These packages have a Lead-free second level interconnect . The category of second level interconnect is marked on the package and on the inner box label, in compliance with JEDEC Standard JESD97. The maximum ratings related to soldering conditions are also marked on the inner box label. ECOPACK is an ST trademark. ECOPACK specifications are available at: www.st.com.

Table 5. SMA dimensions

Ref.	Dimensions			
	Millimeters		Inches	
	Min.	Max.	Min.	Max.
A1	1.90	2.03	0.075	0.08
A2	0.05	0.20	0.002	0.008
b	1.25	1.65	0.049	0.065
c	0.15	0.40	0.006	0.016
D	2.25	2.90	0.089	0.114
E	4.80	5.35	0.189	0.211
E1	3.95	4.60	0.156	0.181
L	0.75	1.50	0.030	0.059

Figure 11. SMA footprint dimensions

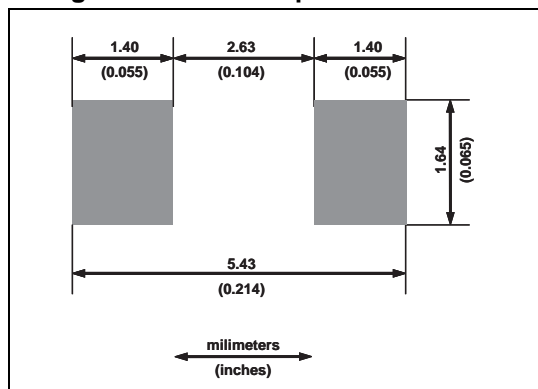

Figure 12. Marking information

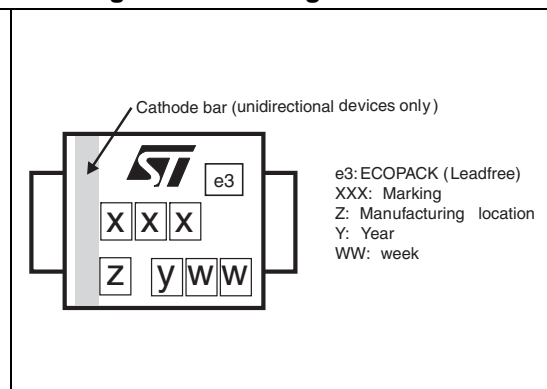

Table 6. Marking

Type	Marking	Type	Marking
SMA6J5.0A-TR	6UA	SMA6J5.0CA-TR	6BA
SMA6J6.0A-TR	6UB	SMA6J6.0CA-TR	6BB
SMA6J6.5A-TR	6UC	SMA6J6.5CA-TR	6BC
SMA6J8.5A-TR	6UD	SMA6J8.5CA-TR	6BD
SMA6J10A-TR	6UE	SMA6J10CA-TR	6BE
SMA6J12A-TR	6UF	SMA6J12CA-TR	6BF
SMA6J13A-TR	6UG	SMA6J13CA-TR	6BG
SMA6J15A-TR	6UH	SMA6J15CA-TR	6BH
SMA6J18A-TR	6UJ	SMA6J18CA-TR	6BJ
SMA6J20A-TR	6UK	SMA6J20CA-TR	6BK
SMA6J24A-TR	6UM	SMA6J24CA-TR	6BM
SMA6J26A-TR	6UN	SMA6J26CA-TR	6BN
SMA6J28A-TR	6UO	SMA6J28CA-TR	6BO
SMA6J33A-TR	6UQ	SMA6J33CA-TR	6BQ
SMA6J40A-TR	6UR	SMA6J40CA-TR	6BR
SMA6J48A-TR	6US	SMA6J48CA-TR	6BS
SMA6J58A-TR	6UT	SMA6J58CA-TR	6BT
SMA6J70A-TR	6UU	SMA6J70CA-TR	6BU
SMA6J85A-TR	6UV	SMA6J85CA-TR	6BV
SMA6J100A-TR	6UW	SMA6J100CA-TR	6BW
SMA6J130A-TR	6UX	SMA6J130CA-TR	6BX
SMA6J154A-TR	6UY	SMA6J154CA-TR	6BY
SMA6J170A-TR	6UZ	SMA6J170CA-TR	6BZ
SMA6J188A-TR	6UAA	SMA6J188CA-TR	6BAA

4 Ordering information

Table 7. Ordering information

Order code ⁽¹⁾	Marking	Package	Weight	Base qty	Delivery mode
SMA6JxxA-TR	See Table 6 .	SMA	0.072 g	5000	Tape and reel
SMA6JxxCA-TR	See Table 6 .	SMA	0.072 g	5000	Tape and reel

1. xx indicates stand-off voltage

5 Revision history

Table 8. Document revision history

Date	Revision	Changes
21-Feb-2007	1	First issue.
07-Nov-2007	2	Updated Description . Improved readability of Ordering information scheme . Reformatted to current standards.
04-Aug-2014	3	Updated weight in Table 7 .

IMPORTANT NOTICE – PLEASE READ CAREFULLY

STMicroelectronics NV and its subsidiaries ("ST") reserve the right to make changes, corrections, enhancements, modifications, and improvements to ST products and/or to this document at any time without notice. Purchasers should obtain the latest relevant information on ST products before placing orders. ST products are sold pursuant to ST's terms and conditions of sale in place at the time of order acknowledgement.

Purchasers are solely responsible for the choice, selection, and use of ST products and ST assumes no liability for application assistance or the design of Purchasers' products.

No license, express or implied, to any intellectual property right is granted by ST herein.

Resale of ST products with provisions different from the information set forth herein shall void any warranty granted by ST for such product.

ST and the ST logo are trademarks of ST. All other product or service names are the property of their respective owners.

Information in this document supersedes and replaces information previously supplied in any prior versions of this document.

© 2014 STMicroelectronics – All rights reserved