

0.5mm pitch, 0.9mm above the board, Flexible Printed Circuit & Flexible Flat Cable ZIF Connectors

FH19C & FH19SC Series

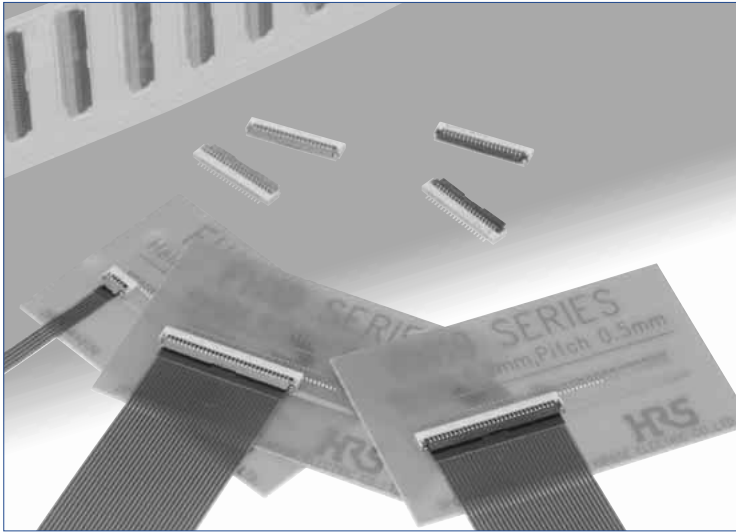

FH19C – FPC/FFC thickness: $0.2 \pm 0.03\text{mm}$

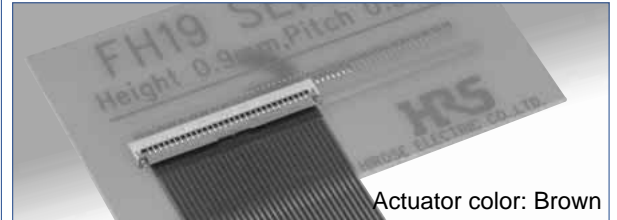

FH19SC – FPC/FFC thickness: $0.3 \pm 0.03\text{mm}$

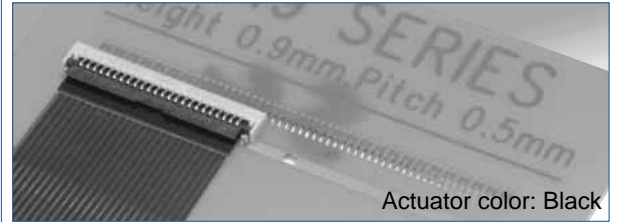

■ Features

1. Low-profile 0.5mm pitch FPC/FFC Connectors

Miniaturization of portable equipment and personal mobile devices has created increased demand for a low profile, high density, and high reliability connectors.

- *The design of this connector has been made thinner and smaller, with a height of 0.9mm and width of 3mm.
- *PCB footprint: Reduced approximately 48% (as compared with Hirose Electric's 0.5mm pitch FH12 Series connectors)
- *Connector weight: Reduced approximately 78% (as compared with Hirose Electric's 0.5mm pitch FH12 Series connectors)

2. Conductive traces on the PCB can run under the connector

All bottom surface of the connector is solid, without any exposure of the contact.

3. Proven Flip-Lock Actuator System assures easy and reliable operation

Rotating actuator permits easy insertion and reliable connection with the FPC & FFC.
 Tactile sensation confirms complete mechanical locking of the actuator and the electrical connection.

4. Accepts 0.2mm & 0.3mm thick FPC/FFC

No exposed contacts on the bottom of the connector.
 The connector will also terminate with 0.2mm thick Flat Flexible Cable (FFC).

5. Board placement with automatic equipment

Flat top surface and packaged on the tape-and-reel allows use of vacuum nozzles.
 Standard reel contains 5,000 pieces.

■ Applications

Notebook PC's, PDA's, digital cameras and other compact devices requiring interconnections of the main circuit board with the LCD, plasma display (PDP), HDD or other compact devices requiring FPC/FFC connections using low profile, high reliability ZIF connectors.

● 0.9mm high

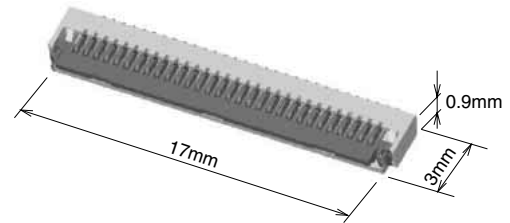

● Can be mounted over conductive traces

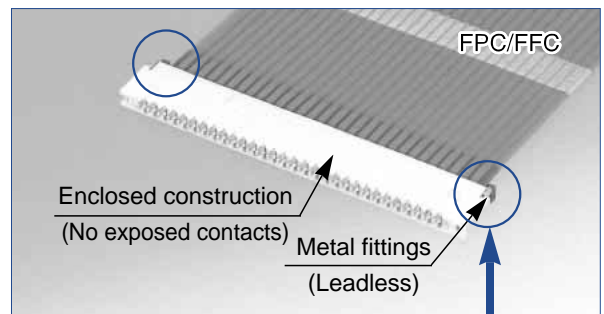

● Metal Fittings (Leadless Type)

No protrusions on the sides allows close side-by-side board placement.



● Actuator Temporary Hold Mechanism



Actuator stays open during insertion of the FPC/FFC.

FH19C & FH19SC Series 0.5mm pitch, 0.9mm above the board, Flexible Printed Circuit & Flexible Flat Cable ZIP Connectors

Product Specifications

Rating	Current rating 0.5 A (Note1)	Operating temperature range -55°C to +85°C (Note 2)	Storage temperature range -10°C to +50°C (Note 3)
	Voltage rating 50 V AC	Operating humidity range Relative humidity 90% max. (No condensation)	Storage humidity range Relative humidity 90% max. (No condensation)

Recommended FPC, FFC	FH19C Series	Thickness: = 0.2 ± 0.03mm Gold plated
	FH19SC Series	Thickness: = 0.3 ± 0.03mm Gold plated

Item	Specification	Conditions
1. Insulation resistance	500 M ohms min.	100 V DC
2. Withstanding voltage	No flashover or insulation breakdown	150 V AC/1 minute
3. Contact resistance	100 m ohms max. *Including FPC/FFC conductor resistance	1 mA
4. Durability (insertion/ withdrawal)	Contact resistance: 100 m ohms max. No damage, cracks, or parts dislocation.	20 cycles
5. Vibration	No electrical discontinuity of 1 μs or more. Contact resistance: 100 m ohms max. No damage, cracks, or parts dislocation.	Frequency: 10 to 55 Hz, single amplitude of 0.75mm, 10 cycles in each of the 3 directions
6. Shock	No electrical discontinuity of 1 μs. min. Contact resistance: 100 m ohms max. No damage, cracks, or parts dislocation.	Acceleration of 981 m/s ² , 6 ms duration, sine half-wave waveform, 3 cycles in each of the 3 axis.
7. Humidity (Steady state)	Contact resistance: 100 m ohms max. Insulation resistance: 100 M ohms min. No damage, cracks, or parts dislocation.	96 hours at temperature of 40°C and humidity of 90 to 95%
8. Temperature cycle	Contact resistance: 100 m ohms max. Insulation resistance: 100 M ohms min. No damage, cracks, or parts dislocation.	Temperature: -55°C → +15°C to +35°C → +85°C → +15°C to +35°C Time : 30 → 2 to 3 → 30 → 2 to 3(Minutes) 5 cycles
9. Resistance to soldering heat	No deformation of components affecting performance.	Reflow: At the recommended temperature profile Manual soldering: 350°C±5°C for 5 seconds

Note 1: When passing the current through all of the contacts, use 70% of the current rating.

Note 2: Includes temperature rise caused by current flow.

Note 3: The term "storage" refers to products stored for long period of time prior to mounting and use. Operating Temperature Range and Humidity range covers non- conducting condition of installed connectors in storage, shipment or during transportation.

Materials

Part	Material	Finish	Remarks
Insulator	LCP	Color: Beige	UL94V-0
Actuator	PPS/LCP	Color: Brown (FH19C Series) Color: Black (FH19SC Series)	
Contacts	Phosphor bronze	Gold flash plated	—
Metal fittings	Phosphor bronze	Pure tin reflow plated	—

Ordering information

FH19 C - 30S - 0.5 SH (05)

① ② ③ ④ ⑤ ⑥

① Series name :	FH19	④ Contact pitch :	0.5mm																
② C :	FPC/FFC thickness : 0.2mm	⑤ Terminal type	SH: SMT horizontal mounting type																
SC :	FPC/FFC thickness : 0.3mm																		
③ No. of contacts :	4 to 50	⑥ Material and plating specifications :																	
			<table border="1"> <thead> <tr> <th colspan="2">Actuator material</th> <th>PPS</th> <th>LCP</th> </tr> </thead> <tbody> <tr> <td>FH19C</td> <td>Contact: Gold flash plated</td> <td>—</td> <td>(05)</td> </tr> <tr> <td>FH19SC 4 to 10 pos.</td> <td>Contact: Gold flash plated</td> <td>(05)</td> <td>—</td> </tr> <tr> <td>FH19SC 11 to 50 pos.</td> <td>Contact: Gold flash plated</td> <td>—</td> <td>(05)</td> </tr> </tbody> </table>	Actuator material		PPS	LCP	FH19C	Contact: Gold flash plated	—	(05)	FH19SC 4 to 10 pos.	Contact: Gold flash plated	(05)	—	FH19SC 11 to 50 pos.	Contact: Gold flash plated	—	(05)
Actuator material		PPS	LCP																
FH19C	Contact: Gold flash plated	—	(05)																
FH19SC 4 to 10 pos.	Contact: Gold flash plated	(05)	—																
FH19SC 11 to 50 pos.	Contact: Gold flash plated	—	(05)																

Connector Dimension

[FH19C Series]

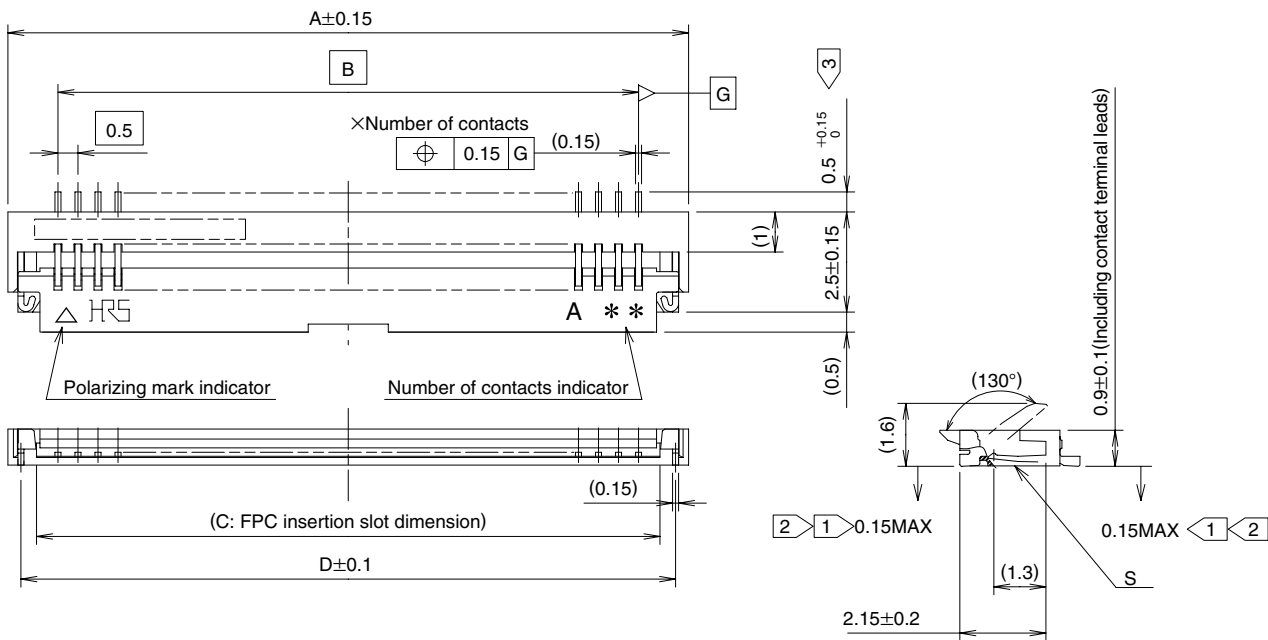

- Notes
- ① The coplanarity of each terminal lead and metal fitting is within 0.1
 - ② The contact terminal lead position indicates the dimension from the bottom surface of the insulator body.
 - ③ Difference between terminal contact to be max. 0.1mm.
 - 4 Any discoloration of the plastic compound will NOT AFFECT form, fit or function of the connector.
Note that preventive hole for sink mark could be added for improvement.

Unit: mm

Part Number	CL No.	Number of Contacts	A	B	C	D	RoHS
FH19C- 4S-0.5SH(05)	CL580-0410-1-05	4	4	1.5	2.57	3.35	YES
FH19C- 6S-0.5SH(05)	CL580-0409-2-05	6	5	2.5	3.57	4.35	
FH19C- 7S-0.5SH(05)	CL580-0411-4-05	7	5.5	3	4.07	4.85	
FH19C- 8S-0.5SH(05)	CL580-0404-9-05	8	6	3.5	4.57	5.35	
FH19C- 9S-0.5SH(05)	CL580-0403-6-05	9	6.5	4	5.07	5.85	
FH19C-10S-0.5SH(05)	CL580-0412-7-05	10	7	4.5	5.57	6.35	
FH19C-12S-0.5SH(05)	CL580-0413-0-05	12	8	5.5	6.57	7.35	
FH19C-13S-0.5SH(05)	CL580-0405-1-05	13	8.5	6	7.07	7.82	
FH19C-15S-0.5SH(05)	CL580-0406-4-05	15	9.5	7	8.07	8.85	
FH19C-17S-0.5SH(05)	CL580-0408-0-05	17	10.5	8	9.07	9.85	
FH19C-20S-0.5SH(05)	CL580-0402-3-05	20	12	9.5	10.57	11.35	
FH19C-21S-0.5SH(05)	CL580-0414-2-05	21	12.5	10	11.07	11.85	
FH19C-24S-0.5SH(05)	CL580-0407-7-05	24	14	11.5	12.57	13.35	
FH19C-27S-0.5SH(05)	CL580-0401-0-05	27	15.5	13	14.07	14.85	
FH19C-30S-0.5SH(05)	CL580-0400-8-05	30	17	14.5	15.57	16.35	
FH19C-34S-0.5SH(05)	CL580-0419-6-05	34	19	16.5	17.57	18.35	
FH19C-40S-0.5SH(05)	CL580-0416-8-05	40	22	19.5	20.57	21.35	
FH19C-50S-0.5SH(05)	CL580-0417-0-05	50	27	24.5	25.57	26.35	

Note1: Embossed tape reel packaging (5,000 pieces/reel).
Order by number of reels.

FH19SC & FH19SC Series 0.5mm pitch, 0.9mm above the board, Flexible Printed Circuit & Flexible Flat Cable ZIP Connectors

[FH19SC Series]

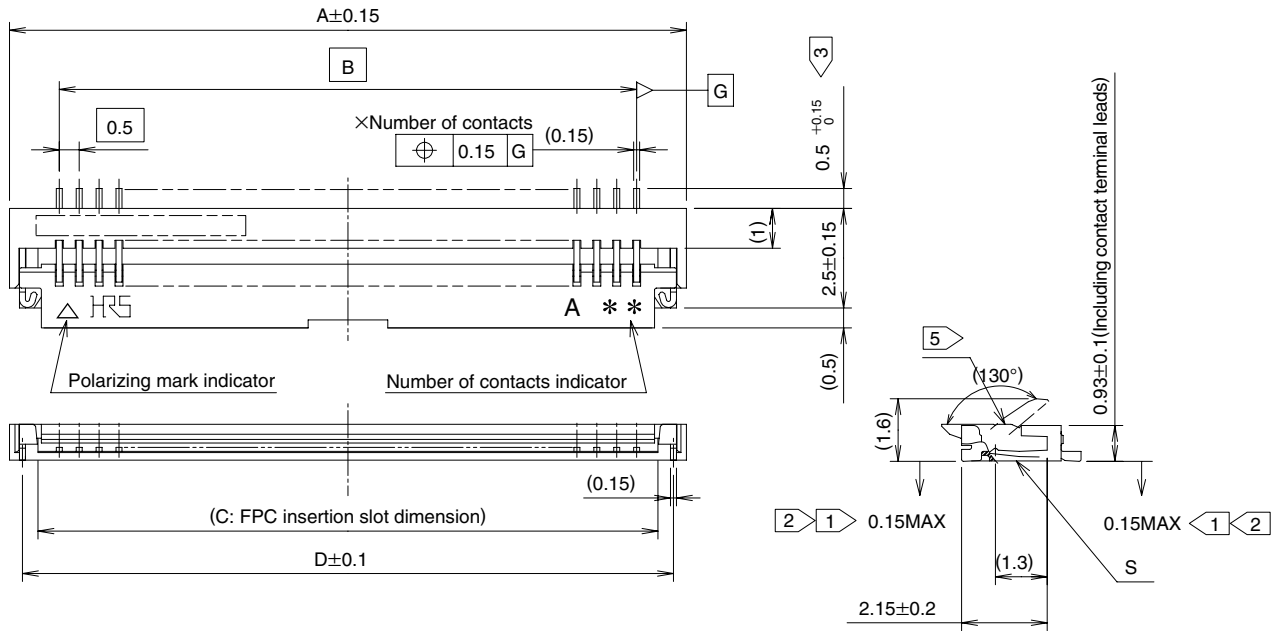

- Notes
- ① The coplanarity of each terminal lead and metal fitting is within 0.1
 - ② The contact terminal lead position indicates the dimension from the bottom surface of the insulator body.
 - ③ Difference between terminal contact to be max. 0.1mm.
 - ④ Any discoloration of the plastic compound will NOT AFFECT form, fit or function of the connector.
 - ⑤ The contacts are protruding 0.03mm max. from the housing top surface.

Unit: mm

Part Number	CL No.	Number of Contacts	A	B	C	D	RoHS
FH19SC- 4S-0.5SH(05)	CL580-0517-5-05	4	4	1.5	2.57	3.35	YES
FH19SC- 5S-0.5SH(05)	CL580-0515-0-05	5	4.5	2	3.07	3.85	
FH19SC- 6S-0.5SH(05)	CL580-0501-5-05	6	5	2.5	3.57	4.35	
FH19SC- 8S-0.5SH(05)	CL580-0520-0-05	8	6	3.5	4.57	5.35	
FH19SC- 9S-0.5SH(05)	CL580-0507-1-05	9	6.5	4	5.07	5.85	
FH19SC-10S-0.5SH(05)	CL580-0508-4-05	10	7	4.5	5.57	6.35	
FH19SC-12S-0.5SH(05)	CL580-0512-1-05	12	8	5.5	6.57	7.35	
FH19SC-13S-0.5SH(05)	CL580-0518-8-05	13	8.5	6	7.07	7.85	
FH19SC-14S-0.5SH(05)	CL580-0509-7-05	14	9	6.5	7.57	8.35	
FH19SC-15S-0.5SH(05)	CL580-0503-0-05	15	9.5	7	8.07	8.85	
FH19SC-16S-0.5SH(05)	CL580-0521-2-05	16	10	7.5	8.57	9.35	
FH19SC-17S-0.5SH(05)	CL580-0504-3-05	17	10.5	8	9.07	9.85	
FH19SC-18S-0.5SH(05)	CL580-0519-0-05	18	11	8.5	9.57	10.35	
FH19SC-20S-0.5SH(05)	CL580-0502-8-05	20	12	9.5	10.57	11.35	
FH19SC-21S-0.5SH(05)	CL580-0505-6-05	21	12.5	10	11.07	11.85	
FH19SC-22S-0.5SH(05)	CL580-0506-9-05	22	13	10.5	11.57	12.35	
FH19SC-24S-0.5SH(05)	CL580-0511-9-05	24	14	11.5	12.57	13.35	
FH19SC-26S-0.5SH(05)	CL580-0510-6-05	26	15	12.5	13.57	14.35	
FH19SC-27S-0.5SH(05)	CL580-0516-2-05	27	15.5	13	14.07	14.85	
FH19SC-28S-0.5SH(05)	CL580-0513-4-05	28	16	13.5	14.57	15.35	
FH19SC-30S-0.5SH(05)	CL580-0500-2-05	30	17	14.5	15.57	16.35	
FH19SC-32S-0.5SH(05)	CL580-0514-7-05	32	18	15.5	16.57	17.35	
FH19SC-40S-0.5SH(05)	CL580-0522-5-05	40	22	19.5	20.57	21.35	
FH19SC-45S-0.5SH(05)	CL580-0523-8-05	45	24.5	22	23.07	23.85	
FH19SC-50S-0.5SH(05)	CL580-0524-0-05	50	27	24.5	25.57	26.35	

Note1: Embossed tape reel packaging (5,000 pieces/reel) .
 Order by number of reels.

◆ Recommended PCB Land and Metal Mask Dimensions

[Common to FH19C & FH19SC Series]

Recommended metal mask thickness: 0.10 mm.

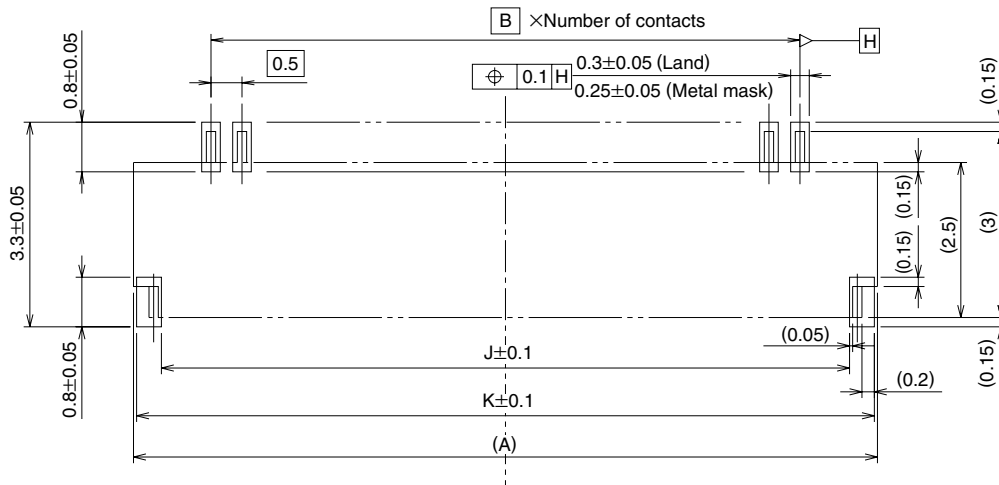

◆ Recommended FPC, FFC Dimensions

[Common to FH19C & FH19SC Series]

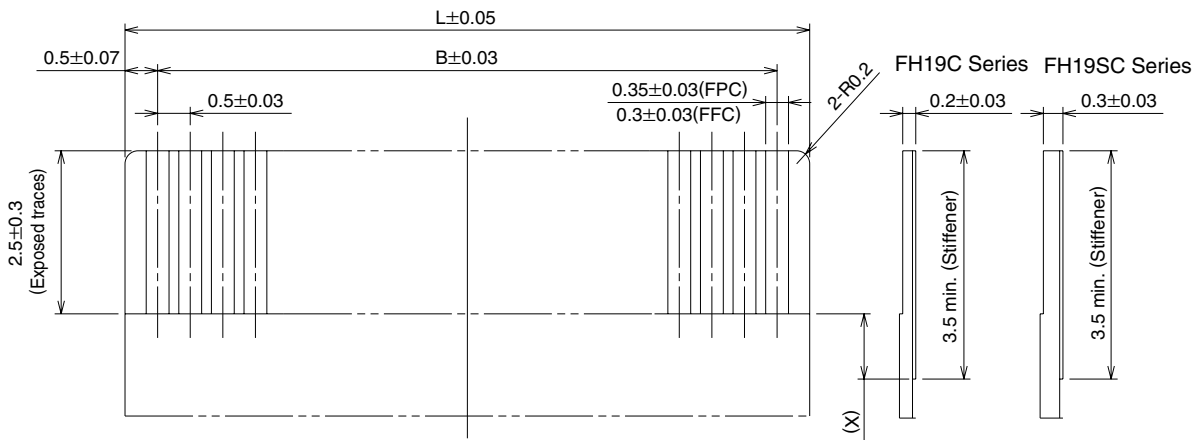

Note1: Polyamide and a thermally hardened adhesive is recommended as the materials for the stiffener.

Note2: Stiffener dimension should be 3.5mm min., and X dimension should be 0.5mm for improved flexibility of FPC.

Unit: mm

Number of Contacts	A	B	J	K	L
4	4.0	1.5	3.1	3.9	2.5
5	4.5	2.0	3.6	4.4	3.0
6	5.0	2.5	4.1	4.9	3.5
7	5.5	3.0	4.6	5.4	4.0
8	6.0	3.5	5.1	5.9	4.5
9	6.5	4.0	5.6	6.4	5.0
10	7.0	4.5	6.1	6.9	5.5
12	8.0	5.5	7.1	7.9	6.5
13	8.5	6.0	7.6	8.4	7.0
14	9.0	6.5	8.1	8.9	7.5
15	9.5	7.0	8.6	9.4	8.0
16	10.0	7.5	9.1	9.9	8.5
17	10.5	8.0	9.6	10.4	9.0
18	11.0	8.5	10.1	10.9	9.5

Unit: mm

Number of Contacts	A	B	J	K	L
20	12.0	9.5	11.1	11.9	10.5
21	12.5	10.0	11.6	12.4	11.0
22	13.0	10.5	12.1	12.9	11.5
24	14.0	11.5	13.1	13.9	12.5
26	15.0	12.5	14.1	14.9	13.5
27	15.5	13.0	14.6	15.4	14.0
28	16.0	13.5	15.1	15.9	14.5
30	17.0	14.5	16.1	16.9	15.5
32	18.0	15.5	17.1	17.9	16.5
34	19.0	16.5	18.1	18.9	17.5
40	22.0	19.5	21.1	21.9	20.5
45	24.5	22.0	23.6	24.4	23.0
50	27.0	24.5	26.1	26.9	25.5

◆ Packaging Specifications

[Common to FH19C & FH19SC Series]

● Embossed Carrier Tape Dimensions

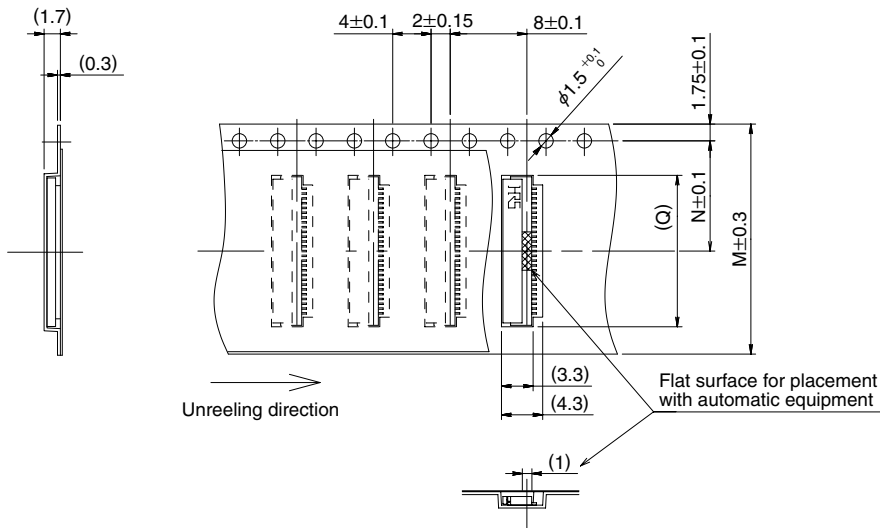

● Reel Dimensions

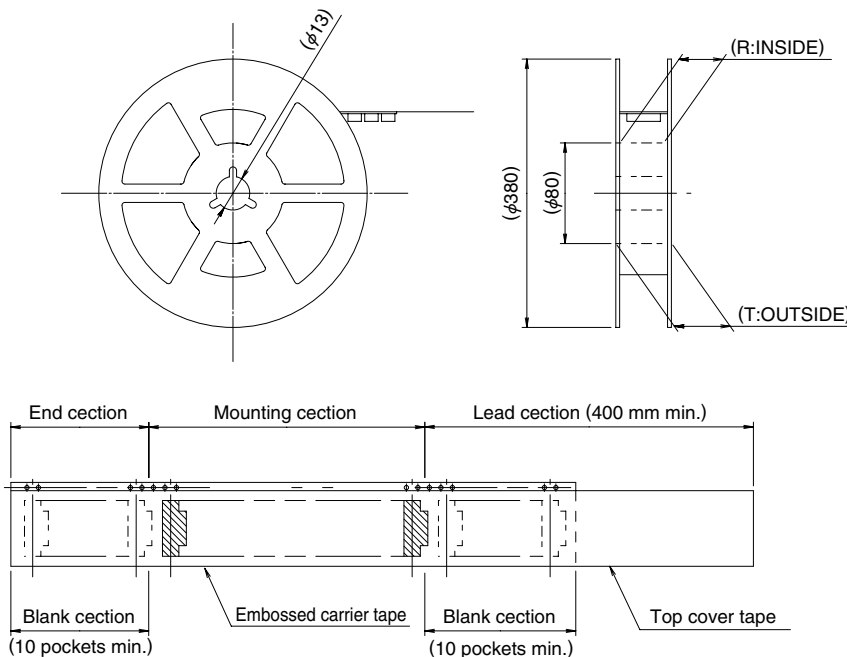

Unit: mm

Number of Contacts	M	N	Q	R	T
4	16	7.5	4.3	17.4	21.4
5	16	7.5	4.8	17.4	21.4
6	16	7.5	5.3	17.4	21.4
7	16	7.5	5.8	17.4	21.4
8	16	7.5	6.3	17.4	21.4
9	16	7.5	6.8	17.4	21.4
10	16	7.5	7.3	17.4	21.4
12	16	7.5	8.3	17.4	21.4
13	16	7.5	8.8	17.4	21.4
14	16	7.5	9.3	17.4	21.4
15	16	7.5	9.8	17.4	21.4
16	24	11.5	10.3	25.4	29.4
17	24	11.5	10.8	25.4	29.4
18	24	11.5	11.3	25.4	29.4

Unit: mm

Number of Contacts	M	N	Q	R	T
20	24	11.5	12.3	25.4	29.4
21	24	11.5	12.8	25.4	29.4
22	24	11.5	13.3	25.4	29.4
24	24	11.5	14.3	25.4	29.4
26	24	11.5	15.3	25.4	29.4
27	24	11.5	15.8	25.4	29.4
28	24	11.5	16.3	25.4	29.4
30	24	11.5	17.3	25.4	29.4
32	32	14.2	18.3	33.4	37.4
34	32	14.2	19.3	33.4	37.4
40	44	20.2	22.3	45.4	49.4
45	44	20.2	24.8	45.4	49.4
50	44	20.2	27.3	45.4	49.4

Note: 5,000 pieces per reel.

Embossed tape 32 mm or wider will have perforated feed holes on two sides.

◆FH19C & FH19SC Series FPC/FFC Construction (Recommended Specifications)

1. Using Single-sided FPC

FPC : Flexible Printed Circuit

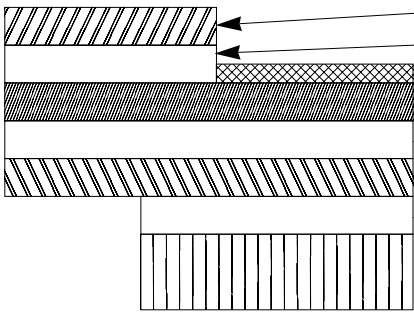

Material Name	Material	Thickness (μm)	
		FH19C	FH19SC
Covering layer film	Polyimide 1 mil thick	25	25
Cover adhesive		25	25
Surface treatment	Nickel under plated 1 to 5μm / Gold plated 0.2μm	3	3
Copper foil	Cu 1oz	35	35
Base adhesive		25	25
Base film	Polyimide 1 mil thick	25	25
Reinforcement material adhesive	Heat-hardened adhesive	30	30
Stiffener	Polyimide 3 mil thick	75	175
Total		193	293

2. Using Double-sided FPC

FPC : Flexible Printed Circuit

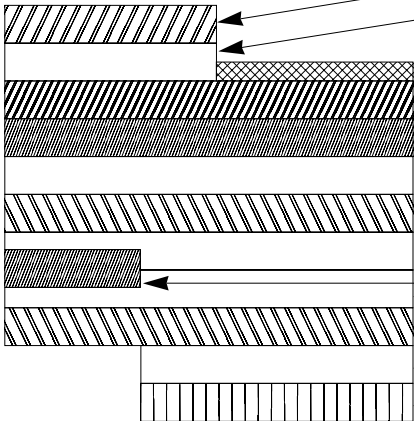

Material Name	Material	Thickness (μm)	
		FH19C	FH19SC
Covering layer film	Polyimide 1 mil thick	25	25
Cover adhesive		25	25
Surface treatment	Nickel under plated 1 to 5μm / Gold plated 0.2μm	3	3
Through-hole copper	Cu	15	15
Copper foil	Cu 1/2oz	18	18
Base adhesive		18	18
Base film	Polyimide 1 mil thick	25	25
Base adhesive		18	18
Copper foil	Cu 1/2oz	18	18
Cover adhesive		25	25
Covering layer film	Polyimide 1 mil thick	25	25
Reinforcement material adhesive	Heat-hardened adhesive	25	50
Stiffener	Polyimide 1 mil thick	25	100
Total		197	297

3. Using FFC (Flexible Flat Cable)

FFC : Flexible Flat Cable

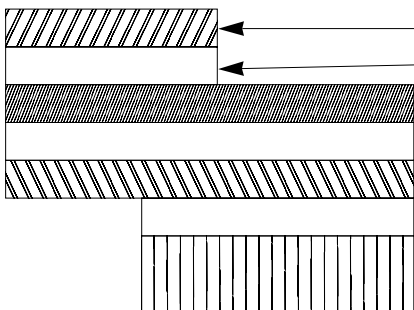

Material Name	Material	Thickness (μm)	
		FH19C	FH19SC
Polyester film		12	12
Adhesive	Polyester thermoplastic type	30	30
(Nickel under plated / Gold plated), soft copper film		35	35
Adhesive	Polyester	30	30
Polyester		12	12
Adhesive	Polyester	30	30
Stiffener	Polyester	100	188
Total		207	295

* Practical tolerance of thickness dimension is $\pm 20\mu\text{m}$ (i.e., 187 to 227μm).

Note 1: This specification is a recommendation for the FH19C, FH19SC Series connectors using 0.2/0.3 $\pm 0.03\text{mm}$ thick FPC/FFC.

◆ Recommended Temperature Profile

[For FH19C & FH19SC Series]

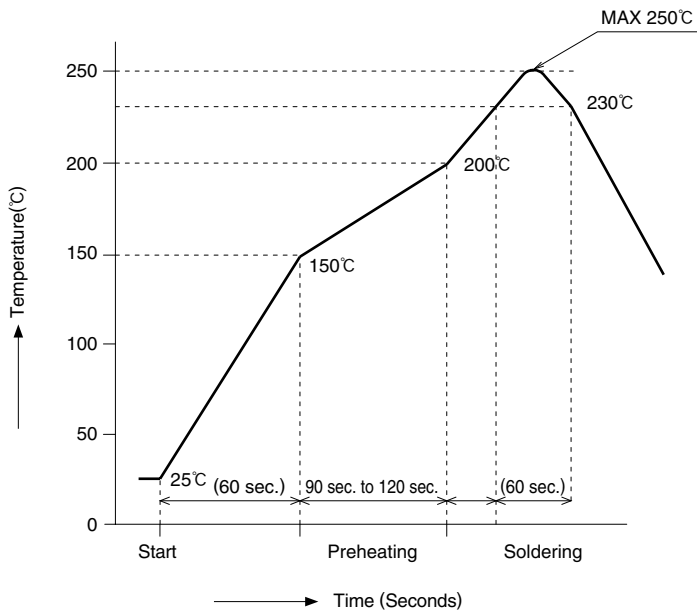

HRS test condition

Solder method	:Reflow, IR/hot air (Nihon Den-netsu Co., Ltd.'s Part Number: SENSBY NR- II)
Environment	:Room air
Solder composition	:Paste, 96.5%Sn/3.0%Ag/0.5%Cu (Senju Metal Industry, Co., Ltd.'s Part Number:M705-221CM5-42-10.5)
Test board	:Glass epoxy 45mm×100mm×1.6mm thick
Land dimensions	:0.3mm×0.8mm
Metal mask	:0.25mm×0.8mm×0.1mm

This temperature profile is based on the above conditions. In individual applications the actual temperature may vary, depending on solder paste type, volume/thickness and board size/thickness. Consult your solder paste and equipment manufacturer for specific recommendations.

FH19C & FH19SC Series 0.5mm pitch, 0.9mm above the board, Flexible Printed Circuit & Flexible Flat Cable ZIF Connectors

◆ Operation and Precautions

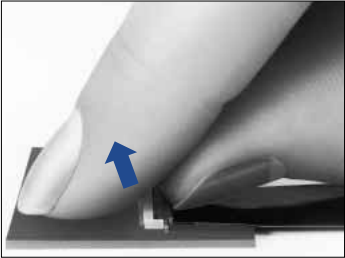
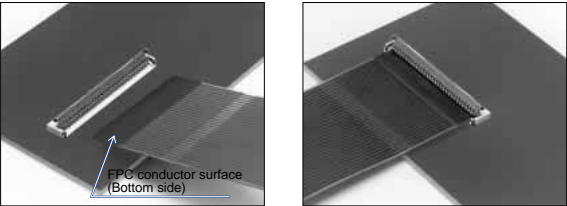
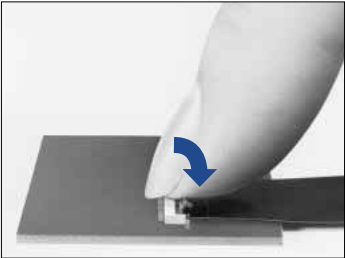
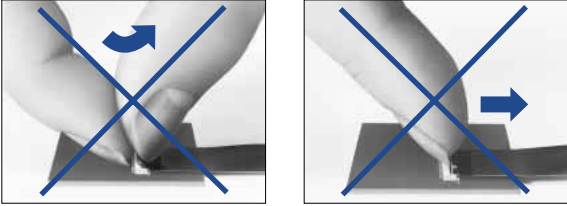
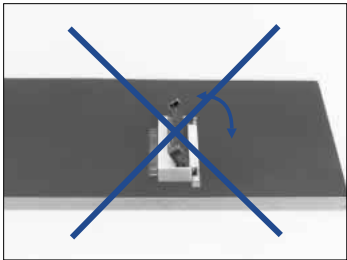
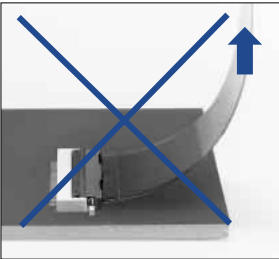
Operation	Precautions
<p>1. FPC/FFC Termination procedure. Connector installed on the board.</p> <p>1) Lift up the actuator. Use thumb or index finger.</p>  <p>2) Assure that the FPC/FFC is fully inserted parallel to mounting surface, with the exposed conductive traces facing down.</p>  <p>3) Rotate down the actuator until firmly closed. It is critical that the inserted FPC/FFC is not moved and remains fully inserted. Should the FPC/FFC be moved, open the actuator and repeat the process, starting with Step 1 above.</p> 	<p>1) Do not apply excessive force or use any type of tool to operate the actuator.</p>  <p>2) The connector will assure reliable performance when the actuator is open to 130° maximum. Do not exceed this angle, as this may cause permanent damage to the connector.</p>  <p>3) Application of excessive force to the inserted FPC/FFC may cause damage to connector and may affect the reliability of electrical connection. If specific application requires continuous or repeated pull or bend of the inserted FPC/FFC, assure that the forces are NOT transmitted directly to the connector.</p> 
<p>2. FPC/FFC Removal</p> <p>1) Lift up the actuator.</p> <p>2) Carefully remove the FPC/FFC.</p> 