

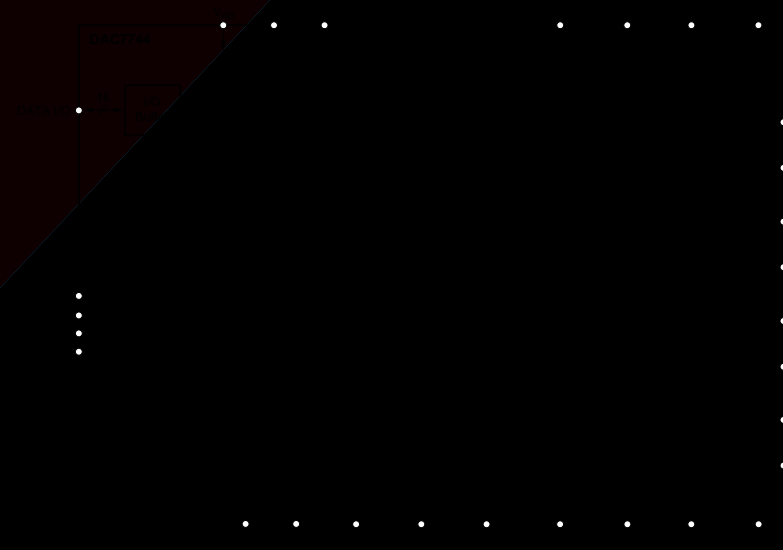

For most current data sheet and other product information, visit [www.burr-brown.com](http://www.burr-brown.com)



International Airport Industrial Park • Mailing Address: PO Box 11400, Tucson, AZ 85734 • Street Address: 6730 S. Tucson Blvd., Tucson, AZ 85706 • Tel: (520) 746-1111  
Twx: 910-952-1111 • Internet: <http://www.burr-brown.com/> • Cable: BBRCORP • Telex: 066-6491 • FAX: (520) 889-1510 • Immediate Product Info: (800) 548-6132

Printed in U.S.A. November, 1999

# SPECIFICATIONS (Dual Supply)

At  $T_A = T_{MIN}$  to  $T_{MAX}$ ,  $V_{CC} = +15V$ ,  $V_{DD} = +5V$ ,  $V_{SS} = -15V$ ,  $V_{REFH} = +10V$ , and  $V_{REFL} = -10V$ , unless otherwise noted.

PARAMETER	CONDITIONS	DAC7744E			DAC7744EB			DAC7744EC			UNITS
		MIN	TYP	MAX	MIN	TYP	MAX	MIN	TYP	MAX	
<b>ACCURACY</b>											
Linearity Error $T_{MIN}$ to $T_{MAX}$	$T = 25^\circ C$			$\pm 3$ $\pm 4$			*			$\pm 2$ $\pm 3$	LSB LSB
Linearity Match			$\pm 4$			*			$\pm 2$		LSB
Differential Linearity Error $T_{MIN}$ to $T_{MAX}$	$T = 25^\circ C$			$\pm 3$ $\pm 3$					$\pm 2$ $\pm 2$		LSB LSB
Monotonicity, $T_{MIN}$ to $T_{MAX}$		14			15			16			Bits
Bipolar Zero Error	$T = 25^\circ C$		$\pm 0.01$	$\pm 0.025$			*			*	% of FSR
Bipolar Zero Error, $T_{MIN}$ to $T_{MAX}$				$\pm 0.05$			*			*	% of FSR
Full-Scale Error	$T = 25^\circ C$			$\pm 0.025$			*			*	% of FSR
Full-Scale Error, $T_{MIN}$ to $T_{MAX}$				$\pm 0.05$			*			*	% of FSR
Bipolar Zero Matching	Channel-to-Channel Matching			$\pm 0.024$			*			*	% of FSR
Full-Scale Matching	Channel-to-Channel Matching			$\pm 0.024$			*			*	% of FSR
Power Supply Rejection Ratio (PSRR)	At Full Scale			25			*			*	ppm/V
<b>ANALOG OUTPUT</b>											
Voltage Output		$V_{REFL}$		$V_{REFH}$	*		*	*		*	V
Output Current		$\pm 5$			*		*	*		*	mA
Maximum Load Capacitance			500			*		*	*	*	pF
Short-Circuit Current			$\pm 20$			*		*	*	*	mA
Short-Circuit Duration	To $V_{SS}$ , $V_{DD}$ or GND		Indefinite			*		*	*	*	
<b>REFERENCE INPUT</b>											
Ref High Input Voltage Range		$V_{REFL} + 1.25$		+10	*		*	*		*	V
Ref Low Input Voltage Range		-10		$V_{REFH} - 1.25$	*		*	*		*	V
Ref High Input Current		-0.3		2.6		*		*	*	*	mA
Ref Low Input Current		-3.2		-0.3		*		*	*	*	mA
<b>DYNAMIC PERFORMANCE</b>											
Settling Time	To $\pm 0.003\%$ , 20V Output Step See Figure 5		9	11		*	*		*	*	$\mu s$
Channel-to-Channel Crosstalk			0.5			*			*	*	LSB
Digital Feedthrough			2			*			*	*	nV-s
Output Noise Voltage	$f = 10kHz$		60			*			*	*	$nV/\sqrt{Hz}$
<b>DIGITAL INPUT</b>											
$V_{IH}$		$0.7 \cdot V_{DD}$		$V_{DD}$	*			*		*	V
$V_{IL}$		0		$0.3 \cdot V_{DD}$			*			*	V
$I_{IH}$				$\pm 10$			*			*	$\mu A$
$I_{IL}$				$\pm 10$			*			*	$\mu A$
<b>DIGITAL OUTPUT</b>											
$V_{OH}$	$I_{OH} = -0.8mA$	3.6	4.5		*	*		*	*	*	V
$V_{OL}$	$I_{OL} = 1.6mA$		0.3	0.4		*	*		*	*	V
<b>POWER SUPPLY</b>											
$V_{DD}$		+4.75	+5.0	+5.25	*	*	*	*	*	*	V
$V_{CC}$		+14.25	+15.0	+15.75	*	*	*	*	*	*	V
$V_{SS}$		-14.25	-15.0	-15.75	*	*	*	*	*	*	V
$I_{DD}$			50			*		*	*	*	$\mu A$
$I_{CC}$			6			*		*	*	*	mA
$I_{SS}$			-5			*		*	*	*	mA
Power			170	200		*		*	*	*	mW
<b>TEMPERATURE RANGE</b>											
Specified Performance		-40		+85	*		*	*		*	$^\circ C$

\* Specifications same as grade to the left.

The information provided herein is believed to be reliable; however, BURR-BROWN assumes no responsibility for inaccuracies or omissions. BURR-BROWN assumes no responsibility for the use of this information, and all use of such information shall be entirely at the user's own risk. Prices and specifications are subject to change without notice. No patent rights or licenses to any of the circuits described herein are implied or granted to any third party. BURR-BROWN does not authorize or warrant any BURR-BROWN product for use in life support devices and/or systems.

# SPECIFICATIONS (Single Supply)

At  $T_A = T_{MIN}$  to  $T_{MAX}$ ,  $V_{CC} = +15V$ ,  $V_{DD} = +5V$ ,  $V_{SS} = GND$ ,  $V_{REFH} = +10V$ , and  $V_{REFL} = +50mV$ , unless otherwise noted.

PARAMETER	CONDITIONS	DAC7744E			DAC7744EB			DAC7744EC			UNITS
		MIN	TYP	MAX	MIN	TYP	MAX	MIN	TYP	MAX	
<b>ACCURACY</b>											
Linearity Error <sup>(1)</sup> $T_{MIN}$ to $T_{MAX}$	$T = 25^\circ C$			$\pm 3$ $\pm 4$			*			$\pm 2$ $\pm 3$	LSB LSB
Linearity Match			$\pm 4$			*			$\pm 2$		LSB
Differential Linearity Error $T_{MIN}$ to $T_{MAX}$	$T = 25^\circ C$			$\pm 3$ $\pm 3$					$\pm 2$ $\pm 2$		LSB LSB
Monotonicity, $T_{MIN}$ to $T_{MAX}$	$T = 25^\circ C$	14	$\pm 0.01$	$\pm 0.025$	15			16		*	Bits
Unipolar Zero	$T = 25^\circ C$			$\pm 0.05$			*			*	% of FSR
Unipolar Zero Error, $T_{MIN}$ to $T_{MAX}$				$\pm 0.05$			*			*	% of FSR
Full-Scale Error	$T = 25^\circ C$			$\pm 0.025$			*			*	% of FSR
Full-Scale Error, $T_{MIN}$ to $T_{MAX}$				$\pm 0.05$			*			*	% of FSR
Unipolar Zero Matching	Channel-to-Channel Matching			$\pm 0.024$			*			*	% of FSR
Full-Scale Matching	Channel-to-Channel Matching			$\pm 0.024$			*			*	% of FSR
Power Supply Rejection Ratio (PSRR)	At Full Scale			25			*			*	ppm/V
<b>ANALOG OUTPUT</b>											
Voltage Output	$V_{REFL} = 0V$ , $V_{SS} = 0V$ $R = 10k\Omega$	0		$V_{REFH}$	*		*	*		*	V
Output Current		$\pm 5$			*			*		*	mA
Maximum Load Capacitance			500			*		*	*	*	pF
Short-Circuit Current			$\pm 20$			*		*	*	*	mA
Short-Circuit Duration	To $V_{SS}$ , $V_{CC}$ or GND		Indefinite			*		*	*	*	
<b>REFERENCE INPUT</b>											
Ref High Input Voltage Range		$V_{REFL} + 1.25$		+10	*		*	*		*	V
Ref Low Input Voltage Range		0		$V_{REFH} - 1.25$	*		*	*		*	V
Ref High Input Current		-0.3		1.0		*			*	*	mA
Ref Low Input Current		-1.5		-0.3		*			*	*	mA
<b>DYNAMIC PERFORMANCE</b>											
Settling Time	To $\pm 0.003\%$ , 10V Output Step See Figure 6		8	10		*	*		*	*	$\mu s$
Channel-to-Channel Crosstalk			0.5			*			*	*	LSB
Digital Feedthrough			2			*			*	*	nV-s
Output Noise Voltage	$f = 10kHz$		60			*			*	*	$nV/\sqrt{Hz}$
<b>DIGITAL INPUT</b>											
$V_{IH}$		$0.7 \cdot V_{DD}$		$V_{DD}$	*			*		*	V
$V_{IL}$		0		$0.3 \cdot V_{DD}$			*		*	*	V
$I_{IH}$				$\pm 10$			*		*	*	$\mu A$
$I_{IL}$				$\pm 10$			*		*	*	$\mu A$
<b>DIGITAL OUTPUT</b>											
$V_{OH}$	$I_{OH} = -0.8mA$	3.6	4.5		*	*		*	*	*	V
$V_{OL}$	$I_{OL} = 1.6mA$		0.3	0.4		*	*		*	*	V
<b>POWER SUPPLY</b>											
$V_{DD}$		+4.75	+5.0	+5.25	*	*	*	*	*	*	V
$V_{CC}$		+14.25	+15.0	+15.75	*	*	*	*	*	*	V
$V_{SS}$			0			*			*	*	V
$I_{DD}$			50			*			*	*	$\mu A$
$I_{CC}$			3.5			*			*	*	mA
Power			50	70		*			*	*	mW
<b>TEMPERATURE RANGE</b>											
Specified Performance		-40		+85	*		*	*		*	$^\circ C$

\* Specifications same as grade to the left.

NOTE: (1) If  $V_{SS} = 0V$ , the specification applies at code 0021<sub>H</sub> and above, due to possible negative zero scale error.

## ABSOLUTE MAXIMUM RATINGS<sup>(1)</sup>

$V_{CC}$ to $V_{SS}$ .....	-0.3V to +32V
$V_{CC}$ to AGND .....	-0.3V to +16V
$V_{SS}$ to AGND .....	+0.3V to -16V
AGND to DGND .....	-0.3V to +0.3V
$V_{REFH}$ to AGND .....	-9V to +11V
$V_{REFL}$ to AGND .....	-11V to +9V
$V_{DD}$ to GND .....	-0.3V to +6V
$V_{REFH}$ to $V_{REFL}$ .....	-1V to 22V
Digital Input Voltage to GND .....	-0.3V to $V_{DD} + 0.3V$
Digital Output Voltage to GND .....	-0.3V to $V_{DD} + 0.3V$
Maximum Junction Temperature .....	+150°C
Operating Temperature Range .....	-40°C to +85°C
Storage Temperature Range .....	-65°C to +150°C
Lead Temperature (soldering, 10s) .....	+300°C

NOTE: (1) Stresses above those listed under "Absolute Maximum Ratings" may cause permanent damage to the device. Exposure to absolute maximum conditions for extended periods may affect device reliability.



## ELECTROSTATIC DISCHARGE SENSITIVITY

This integrated circuit can be damaged by ESD. Burr-Brown recommends that all integrated circuits be handled with appropriate precautions. Failure to observe proper handling and installation procedures can cause damage.

ESD damage can range from subtle performance degradation to complete device failure. Precision integrated circuits may be more susceptible to damage because very small parametric changes could cause the device not to meet its published specifications.

## PACKAGE/ORDERING INFORMATION

PRODUCT	LINEARITY ERROR (LSB)	DIFFERENTIAL NONLINEARITY (LSB)	PACKAGE	PACKAGE DRAWING NUMBER	SPECIFICATION TEMPERATURE RANGE	ORDERING NUMBER <sup>(1)</sup>	TRANSPORT MEDIA
DAC7744E	±4	±3	48-Lead SSOP	333	-40°C to +85°C	DAC7744E	Rails
"	"	"	"	"	"	DAC7744E/1K	Tape and Reel
DAC7744EB	±4	±2	48-Lead SSOP	333	-40°C to +85°C	DAC7744EB	Rails
"	"	"	"	"	"	DAC7744EB/1K	Tape and Reel
DAC7744EC	±3	±1	48-Lead SSOP	333	-40°C to +85°C	DAC7744EC	Rails
"	"	"	"	"	"	DAC7744EC/1K	Tape and Reel

NOTE: (1) Models with a slash (/) are available only in Tape and Reel in the quantities indicated (e.g., /1K indicates 1000 devices per reel). Ordering 1000 pieces of "DAC7744E/1K" will get a single 1000-piece Tape and Reel.

## ESD PROTECTION CIRCUITS

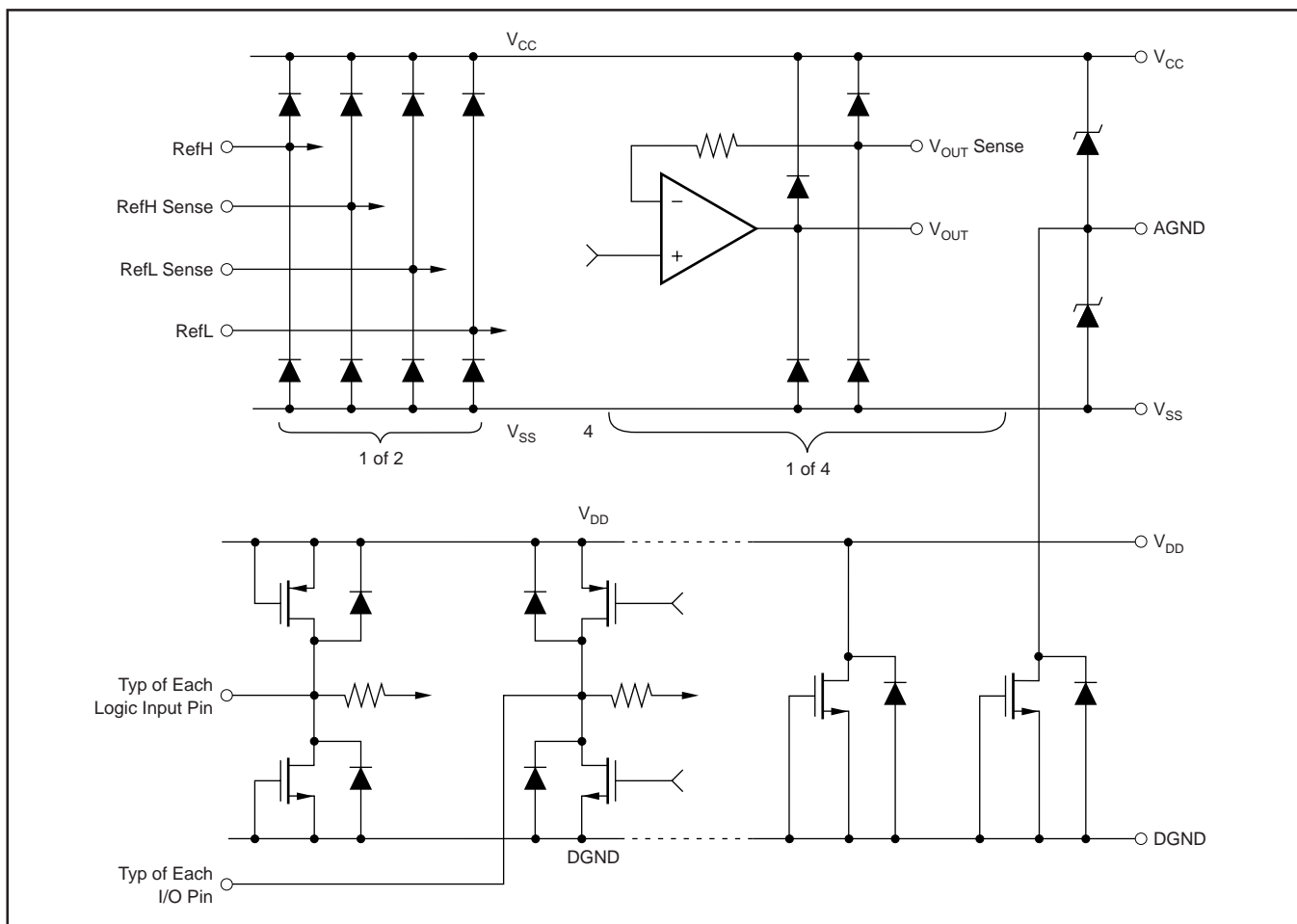

## PIN CONFIGURATION

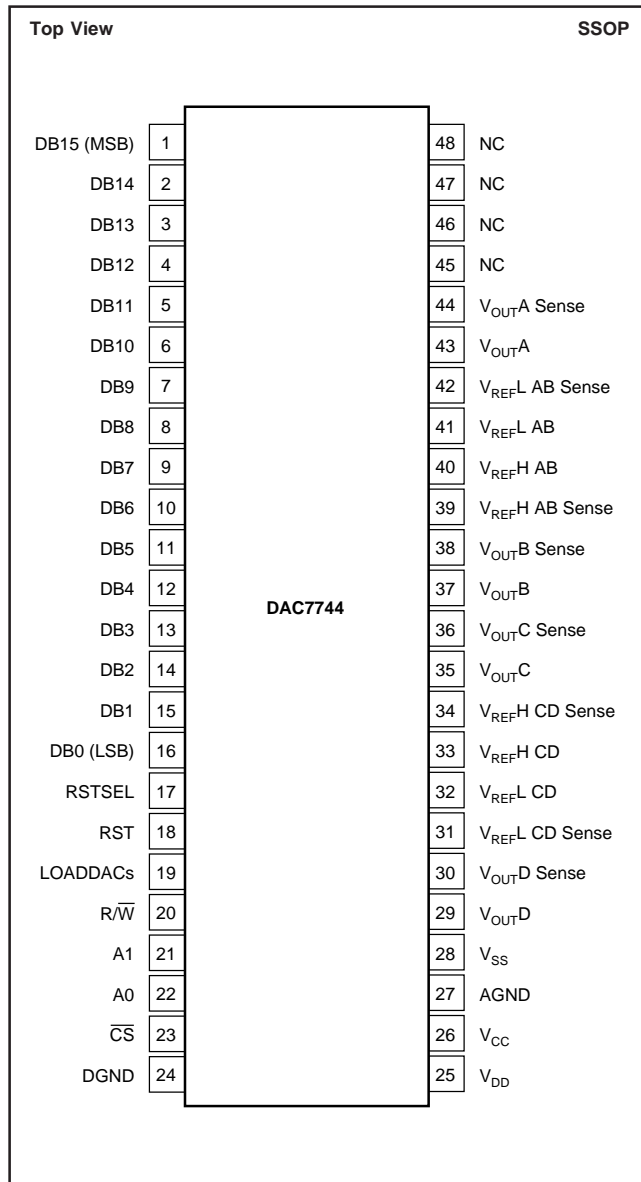

## PIN DESCRIPTIONS

PIN	NAME	DESCRIPTION
1	DB15	Data Bit 15, MSB
2	DB14	Data Bit 14
3	DB13	Data Bit 13
4	DB12	Data Bit 12
5	DB11	Data Bit 11
6	DB10	Data Bit 10
7	DB9	Data Bit 9
8	DB8	Data Bit 8
9	DB7	Data Bit 7
10	DB6	Data Bit 6
11	DB5	Data Bit 5
12	DB4	Data Bit 4
13	DB3	Data Bit 3
14	DB2	Data Bit 2
15	DB1	Data Bit 1
16	DB0	Data Bit 0, LSB
17	RSTSEL	Reset Select. Determines the action of RST. If HIGH, a RST command will set the DAC registers to mid-scale. If LOW, a RST command will set the DAC registers to zero.
18	RST	Reset, Edge-Triggered. Depending on the state of RSTSEL, the DAC Input and Output registers are set to either mid-scale or zero.
19	LOADDACs	DAC Output Registers Load Control. Rising edge triggered.
20	R/W	Enabled by the $\overline{CS}$ , controls data read and write from the input register.
21	A1	Enabled by the $\overline{CS}$ , in combination with A0 selects the Individual DAC Input Registers.
22	A0	Enabled by the $\overline{CS}$ , in combination with A1 selects the individual DAC input registers.
23	$\overline{CS}$	Chip Select, Active LOW.
24	DGND	Digital Ground
25	V <sub>DD</sub>	Positive Power Supply
26	V <sub>CC</sub>	Positive Power Supply
27	AGND	Analog Ground
28	V <sub>SS</sub>	Negative Power Supply
29	V <sub>OUTD</sub>	DAC D Voltage Output
30	V <sub>OUTD</sub> Sense	DAC D's Output Amplifier Inverting Input. Used to close the feedback loop at the load.
31	V <sub>REFL</sub> CD Sense	DAC C and D Reference Low Sense Input
32	V <sub>REFL</sub> CD	DAC C and D Reference Low Input
33	V <sub>REFH</sub> CD	DAC C and D Reference High Input
34	V <sub>REFH</sub> CD Sense	DAC C and D Reference High Sense Input
35	V <sub>OUTC</sub>	DAC C Voltage Output
36	V <sub>OUTC</sub> Sense	DAC C's Output Amplifier Inverting Input. Used to close the feedback loop at the load.
37	V <sub>OUTB</sub>	DAC B Voltage Output
38	V <sub>OUTB</sub> Sense	DAC B's Output Amplifier Inverting Input. Used to close the feedback loop at the load.
39	V <sub>REFH</sub> AB Sense	DAC A and B Reference High Sense Input
40	V <sub>REFH</sub> AB	DAC A and B Reference High Input
41	V <sub>REFL</sub> AB	DAC A and B Reference Low Input
42	V <sub>REFL</sub> AB Sense	DAC A and B Reference Low Sense Input
43	V <sub>OUTA</sub>	DAC A Voltage Input
44	V <sub>OUTA</sub> Sense	DAC A's Output Amplifier Inverting Input. Used to close the feedback loop at the load.
45	NC	No Connection
46	NC	No Connection
47	NC	No Connection
48	NC	No Connection

# TYPICAL PERFORMANCE CURVES: $V_{SS} = 0V$

At  $T_A = +25^\circ C$ ,  $V_{DD} = +5V$ ,  $V_{CC} = +15V$ ,  $V_{SS} = 0$ ,  $V_{REFH} = +10V$ , and  $V_{REFL} = 0V$ , representative unit, unless otherwise specified.

## +25°C

LINEARITY ERROR AND  
DIFFERENTIAL LINEARITY ERROR vs CODE  
(DAC A, +25°C)

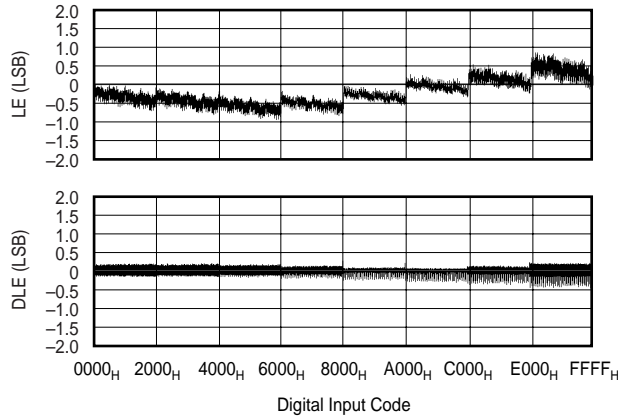

LINEARITY ERROR AND  
DIFFERENTIAL LINEARITY ERROR vs CODE  
(DAC B, +25°C)

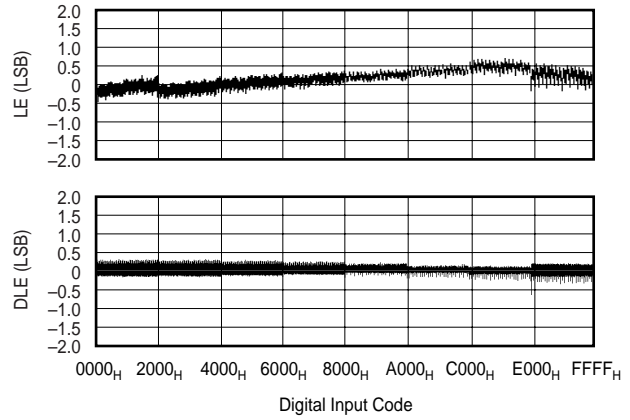

LINEARITY ERROR AND  
DIFFERENTIAL LINEARITY ERROR vs CODE  
(DAC C, +25°C)

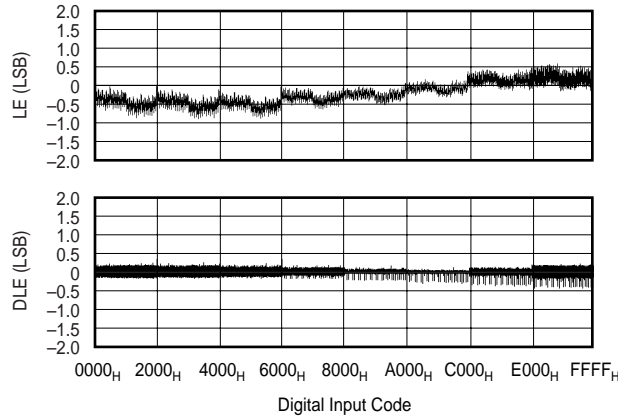

LINEARITY ERROR AND  
DIFFERENTIAL LINEARITY ERROR vs CODE  
(DAC D, +25°C)

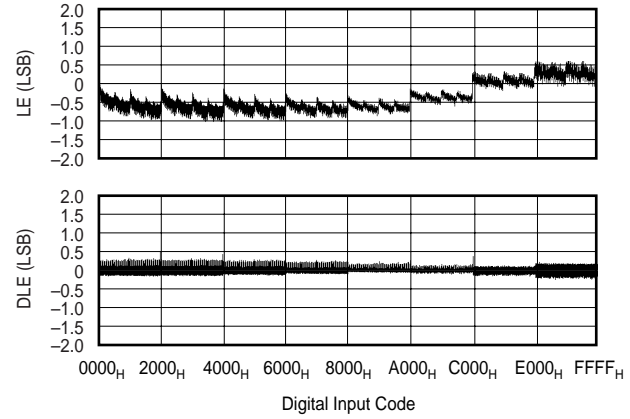

## +85°C

LINEARITY ERROR AND  
DIFFERENTIAL LINEARITY ERROR vs CODE  
(DAC A, +85°C)

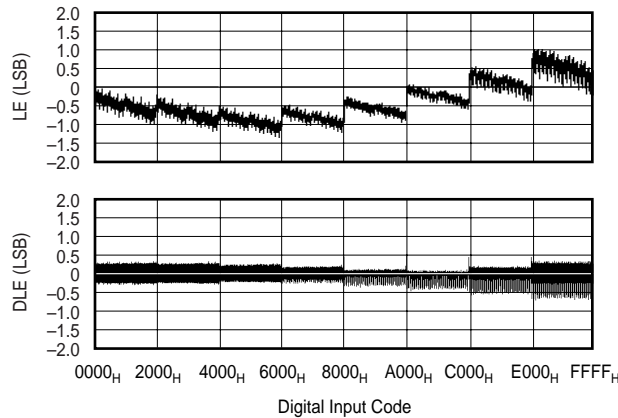

LINEARITY ERROR AND  
DIFFERENTIAL LINEARITY ERROR vs CODE  
(DAC B, +85°C)

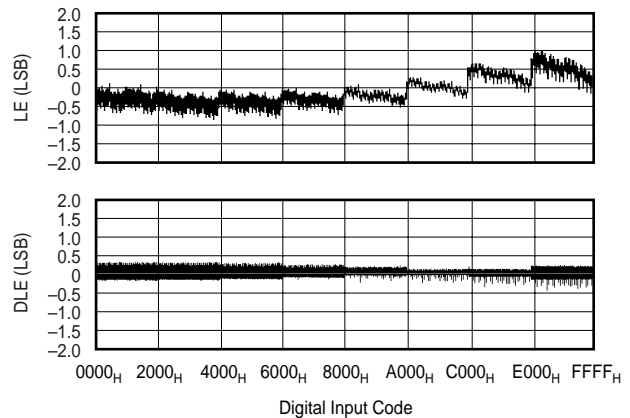

# TYPICAL PERFORMANCE CURVES: $V_{SS} = 0V$ (Cont.)

At  $T_A = +25^\circ C$ ,  $V_{DD} = +5V$ ,  $V_{CC} = +15V$ ,  $V_{SS} = 0$ ,  $V_{REFH} = +10V$ , and  $V_{REFL} = 0V$ , representative unit, unless otherwise specified.

**+85°C (cont.)**

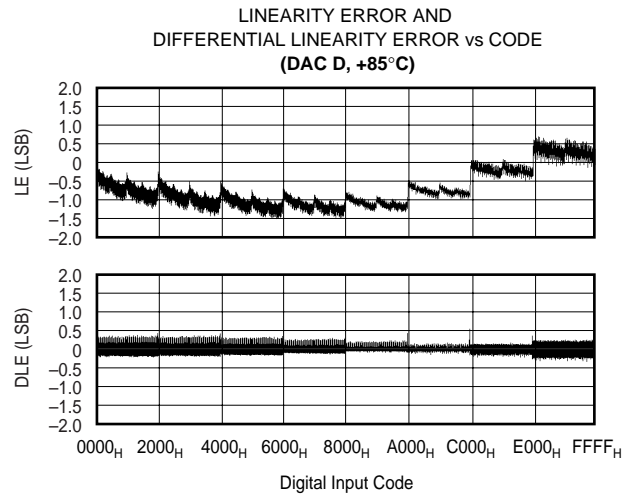
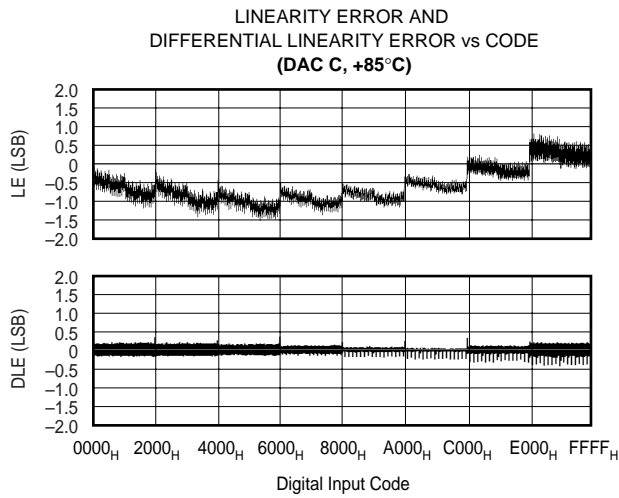

**-40°C**

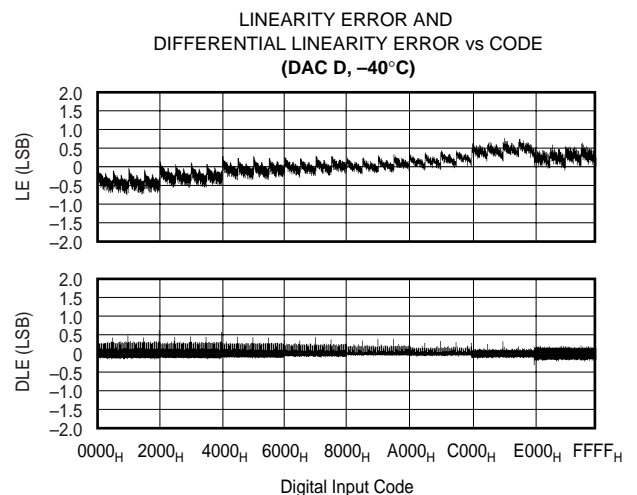
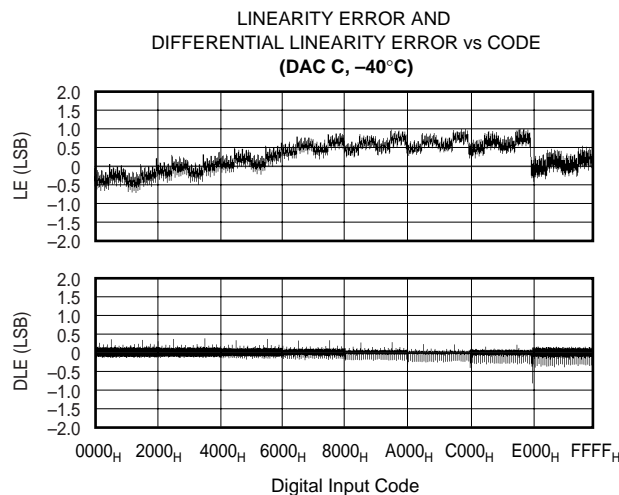
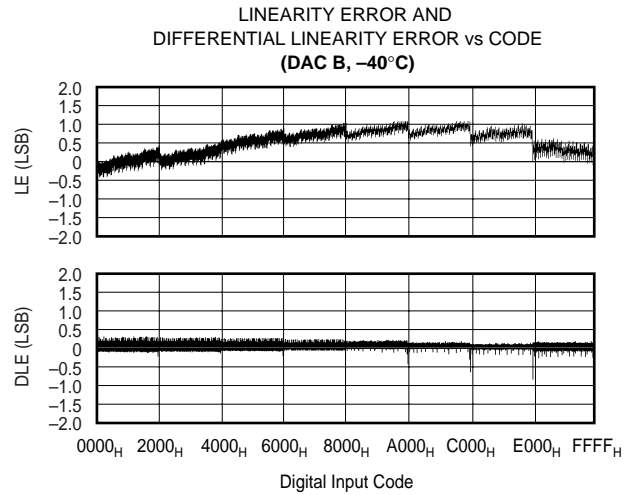
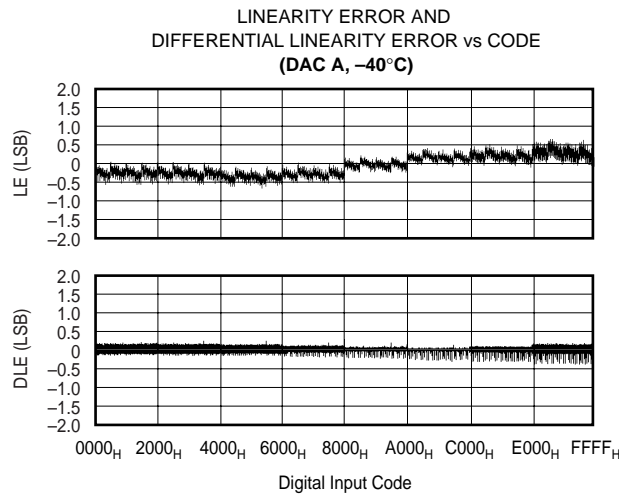

# TYPICAL PERFORMANCE CURVES: $V_{SS} = 0V$ (Cont.)

At  $T_A = +25^\circ C$ ,  $V_{DD} = +5V$ ,  $V_{CC} = +15V$ ,  $V_{SS} = 0$ ,  $V_{REFH} = +10V$ , and  $V_{REFL} = 0V$ , representative unit, unless otherwise specified.

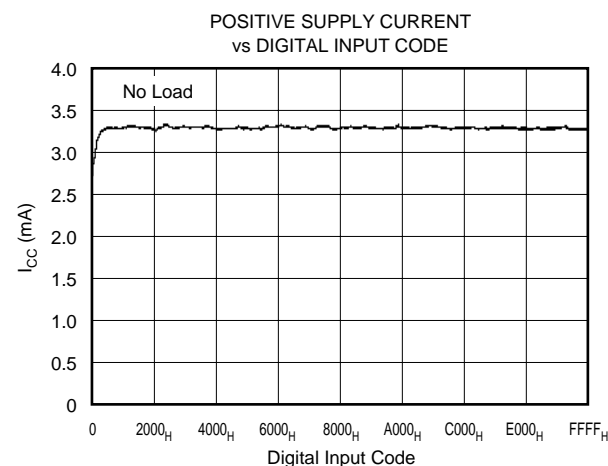
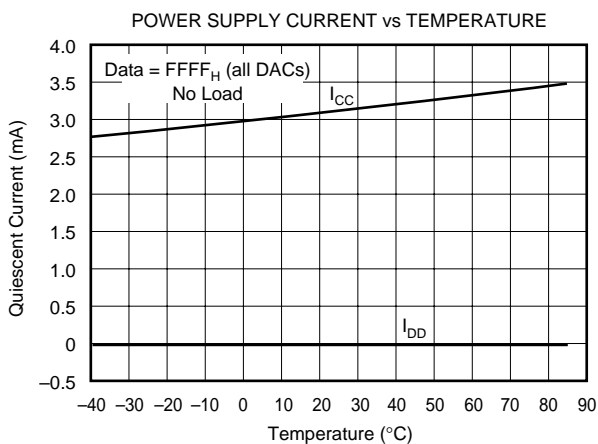
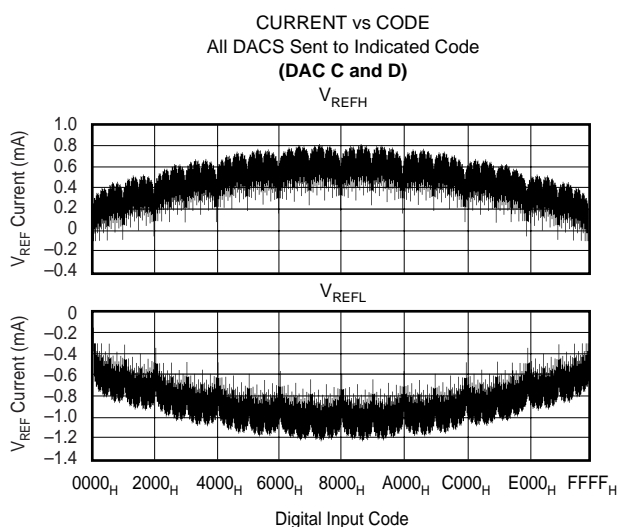
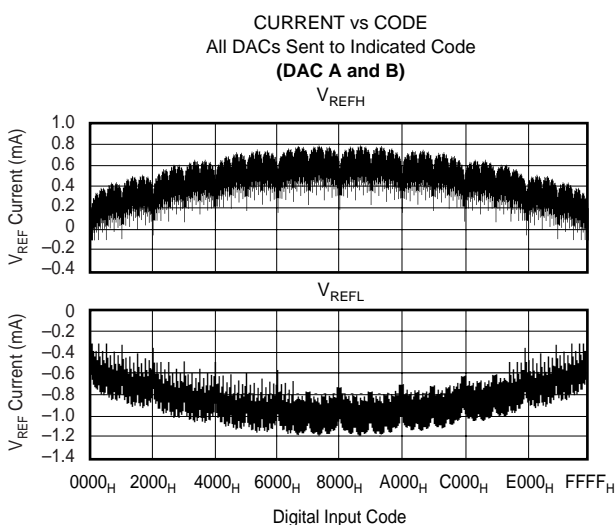
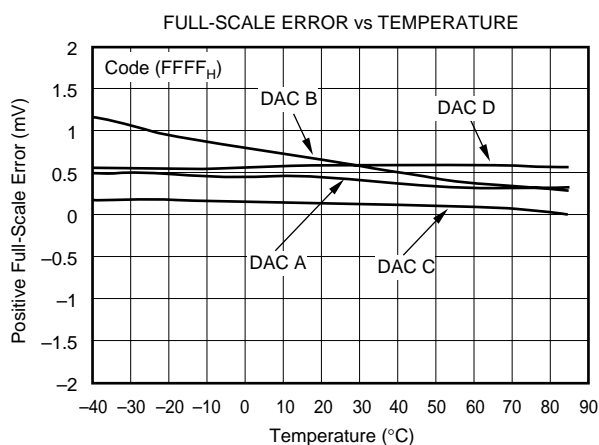
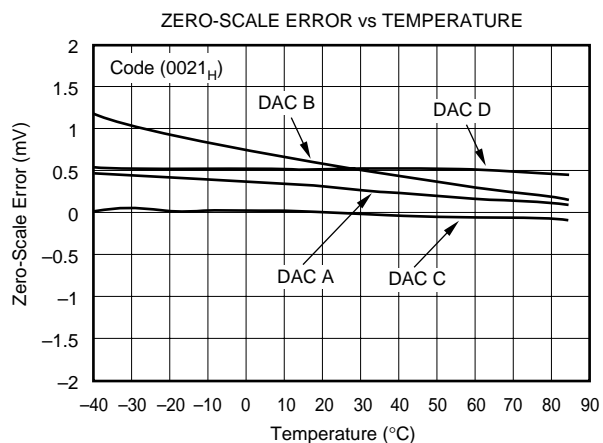



# TYPICAL PERFORMANCE CURVES: $V_{SS} = 0V$ (Cont.)

At  $T_A = +25^\circ C$ ,  $V_{DD} = +5V$ ,  $V_{CC} = +15V$ ,  $V_{SS} = 0$ ,  $V_{REFH} = +10V$ , and  $V_{REFL} = 0V$ , representative unit, unless otherwise specified.

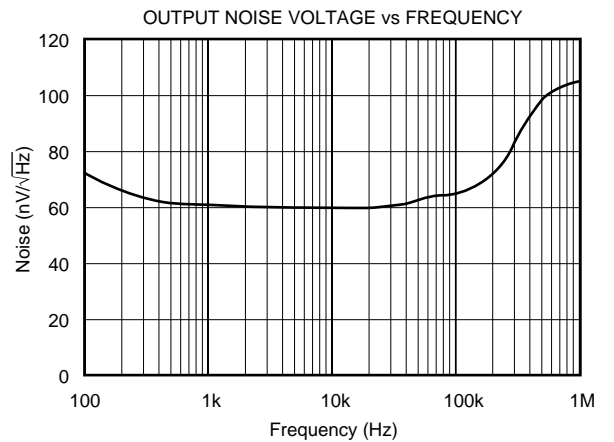
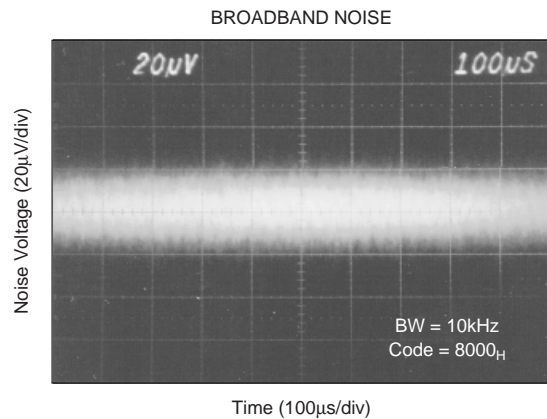
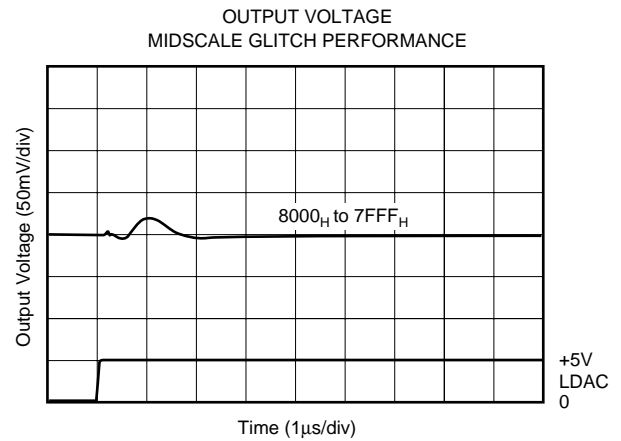
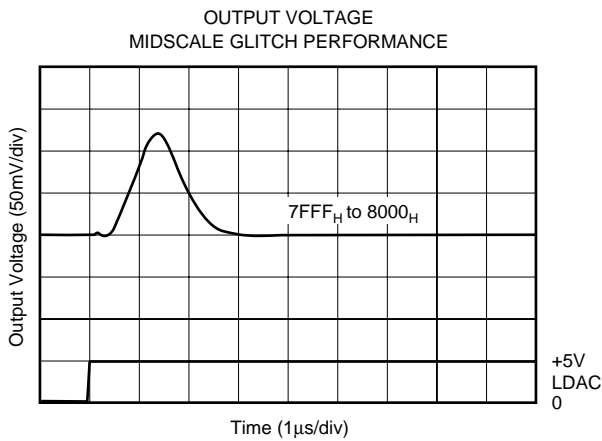
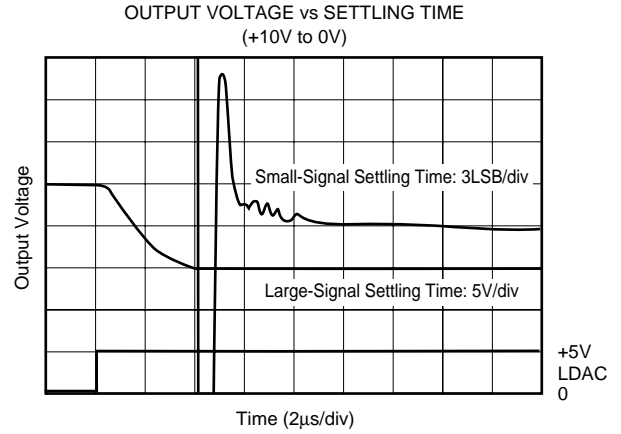
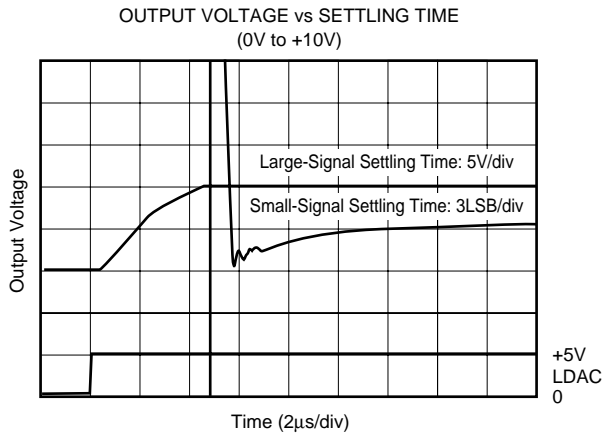

# TYPICAL PERFORMANCE CURVES: $V_{SS} = 0V$ (Cont.)

At  $T_A = +25^\circ C$ ,  $V_{DD} = +5V$ ,  $V_{CC} = +15V$ ,  $V_{SS} = 0$ ,  $V_{REFH} = +10V$ , and  $V_{REFL} = 0V$ , representative unit, unless otherwise specified.

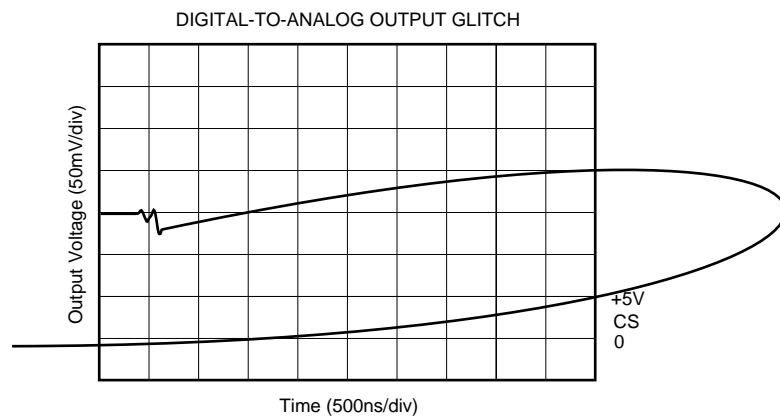
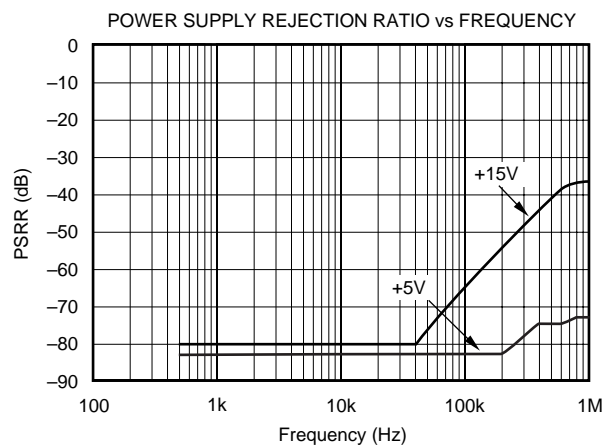
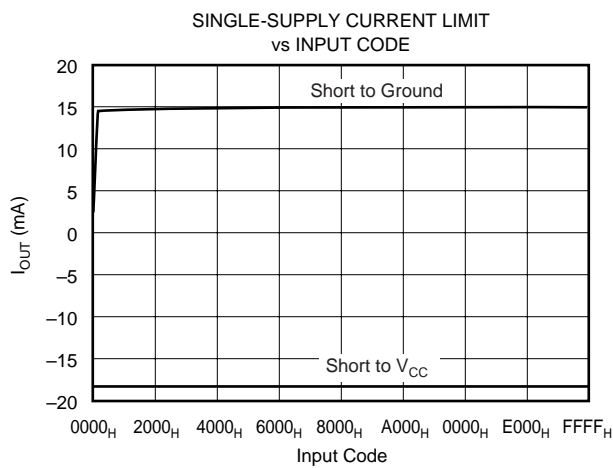
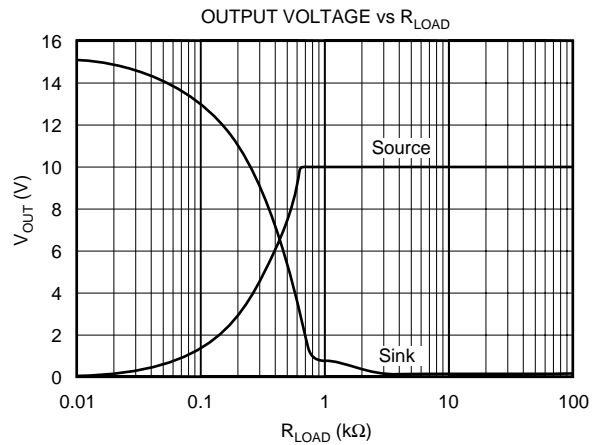
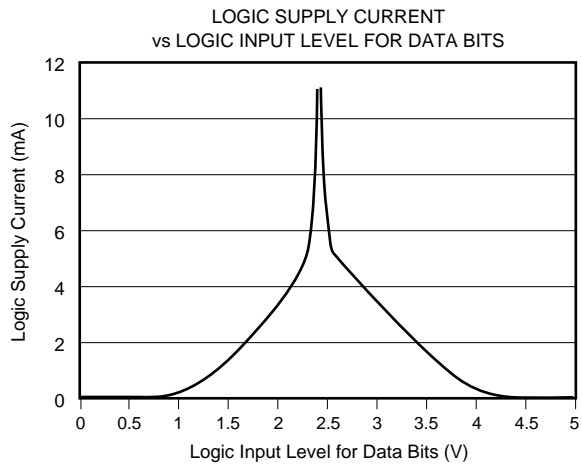

# TYPICAL PERFORMANCE CURVES: $V_{SS} = -15V$

At  $T_A = +25^\circ C$ ,  $V_{DD} = +5V$ ,  $V_{CC} = +15V$ ,  $V_{SS} = -15V$ ,  $V_{REFH} = +10V$ , and  $V_{REFL} = -10V$ , representative unit, unless otherwise specified.

## +25°C

LINEARITY ERROR AND  
DIFFERENTIAL LINEARITY ERROR vs CODE  
(DAC A, +25°C)

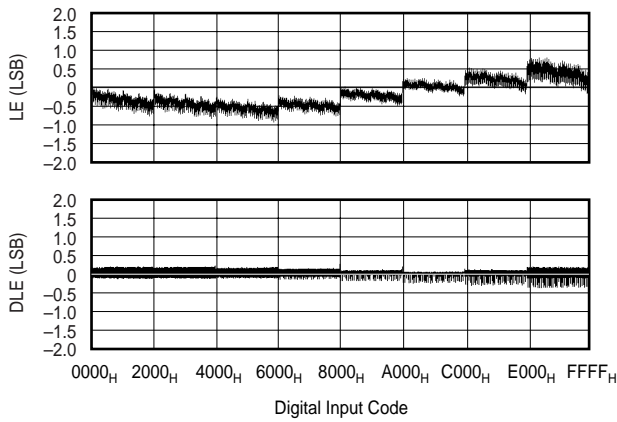

LINEARITY ERROR AND  
DIFFERENTIAL LINEARITY ERROR vs CODE  
(DAC B, +25°C)

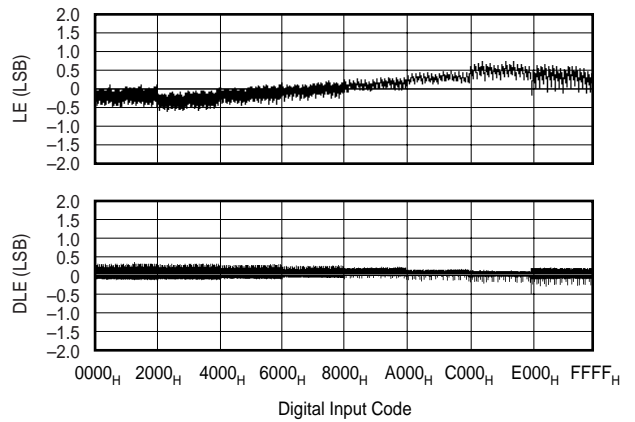

LINEARITY ERROR AND  
DIFFERENTIAL LINEARITY ERROR vs CODE  
(DAC C, +25°C)

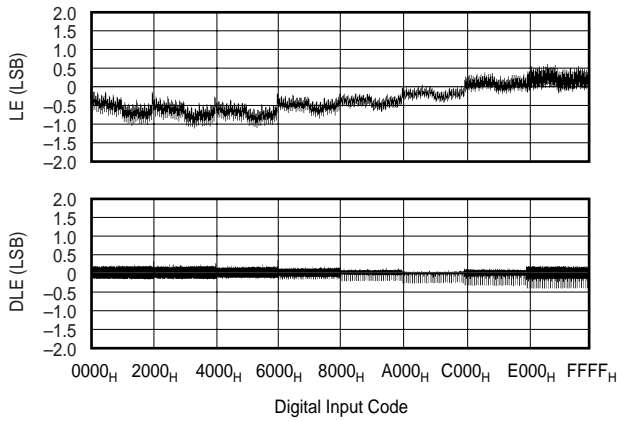

LINEARITY ERROR AND  
DIFFERENTIAL LINEARITY ERROR vs CODE  
(DAC D, +25°C)

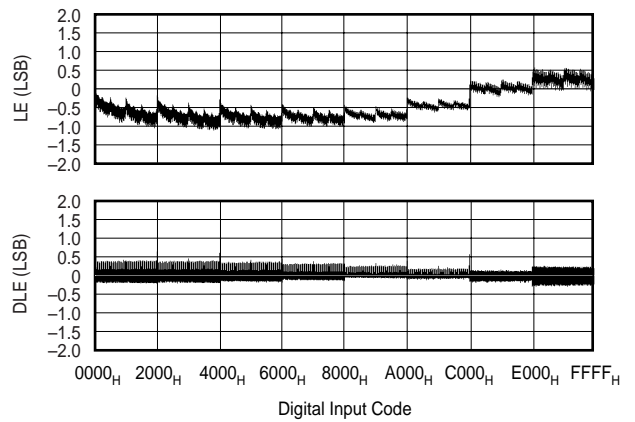

## +85°C

LINEARITY ERROR AND  
DIFFERENTIAL LINEARITY ERROR vs CODE  
(DAC A, +85°C)

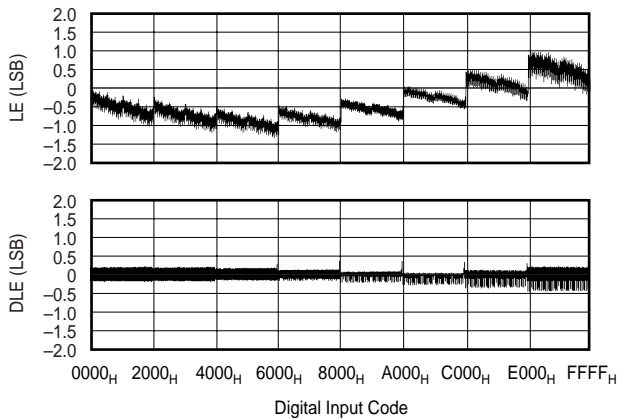

LINEARITY ERROR AND  
DIFFERENTIAL LINEARITY ERROR vs CODE  
(DAC B, +85°C)

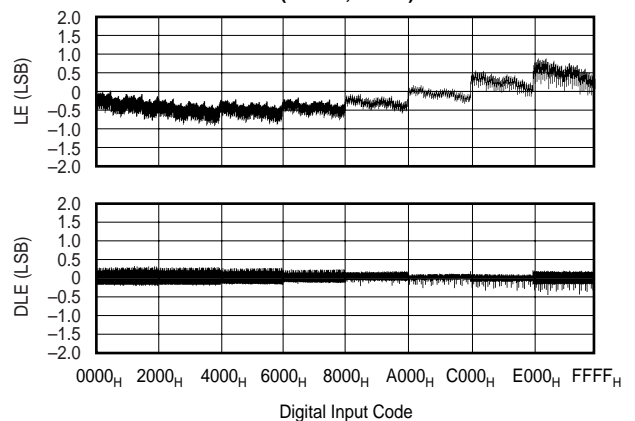

# TYPICAL PERFORMANCE CURVES: $V_{SS} = -15V$ (Cont.)

At  $T_A = +25^\circ C$ ,  $V_{DD} = +5V$ ,  $V_{CC} = +15V$ ,  $V_{SS} = -15V$ ,  $V_{REFH} = +10V$ , and  $V_{REFL} = -10V$ , representative unit, unless otherwise specified.

## +85°C (cont.)

LINEARITY ERROR AND  
DIFFERENTIAL LINEARITY ERROR vs CODE  
(DAC C, +85°C)

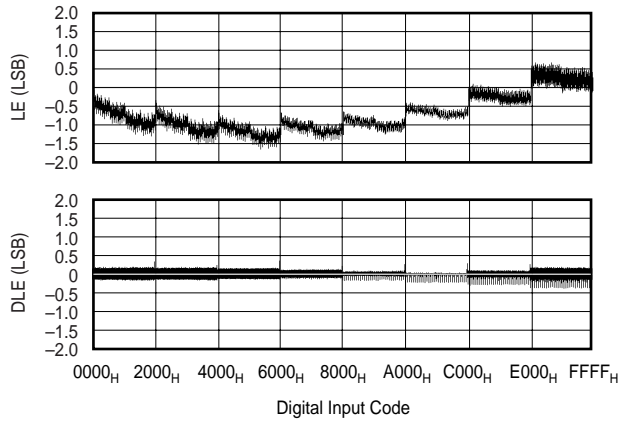

LINEARITY ERROR AND  
DIFFERENTIAL LINEARITY ERROR vs CODE  
(DAC D, +85°C)

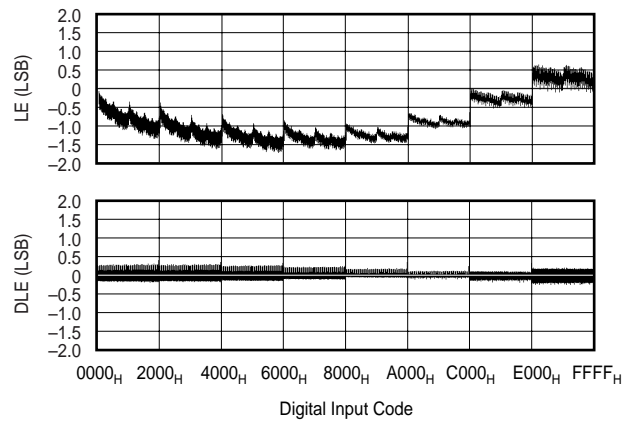

## -40°C

LINEARITY ERROR AND  
DIFFERENTIAL LINEARITY ERROR vs CODE  
(DAC A, -40°C)

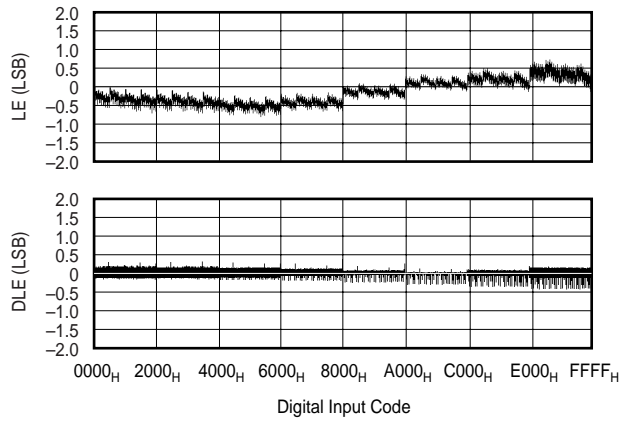

LINEARITY ERROR AND  
DIFFERENTIAL LINEARITY ERROR vs CODE  
(DAC B, -40°C)

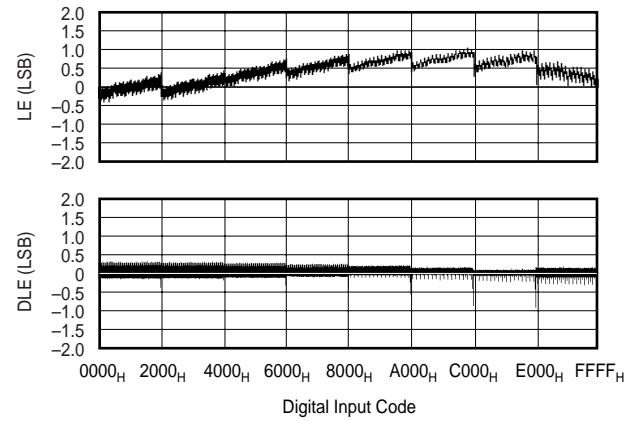

LINEARITY ERROR AND  
DIFFERENTIAL LINEARITY ERROR vs CODE  
(DAC C, -40°C)

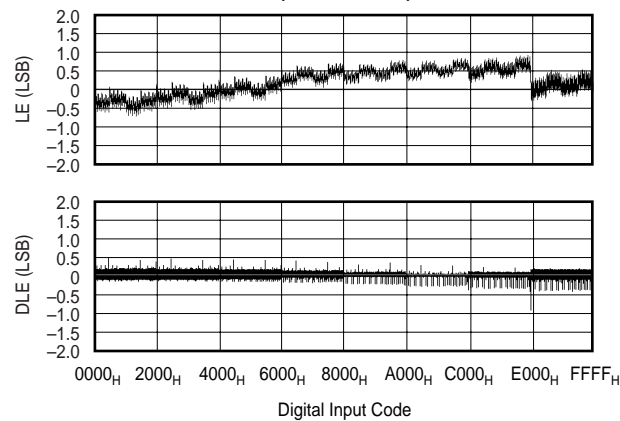

LINEARITY ERROR AND  
DIFFERENTIAL LINEARITY ERROR vs CODE  
(DAC D, -40°C)

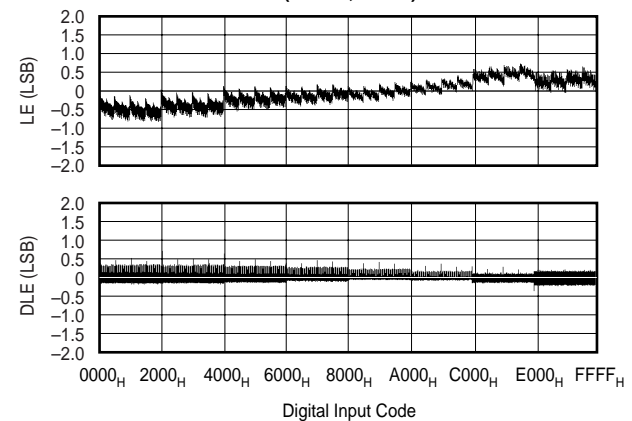

# TYPICAL PERFORMANCE CURVES: $V_{SS} = -15V$ (Cont.)

At  $T_A = +25^\circ C$ ,  $V_{DD} = +5V$ ,  $V_{CC} = +15V$ ,  $V_{SS} = -15V$ ,  $V_{REFH} = +10V$ , and  $V_{REFL} = -10V$ , representative unit, unless otherwise specified.

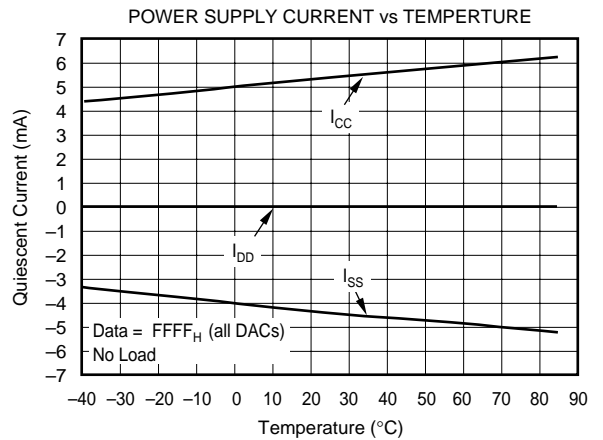
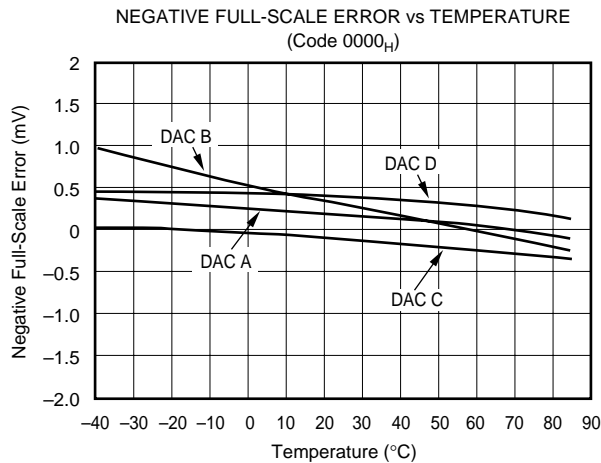
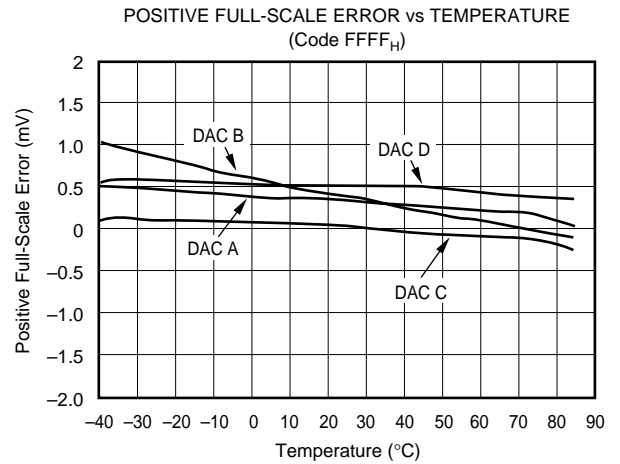
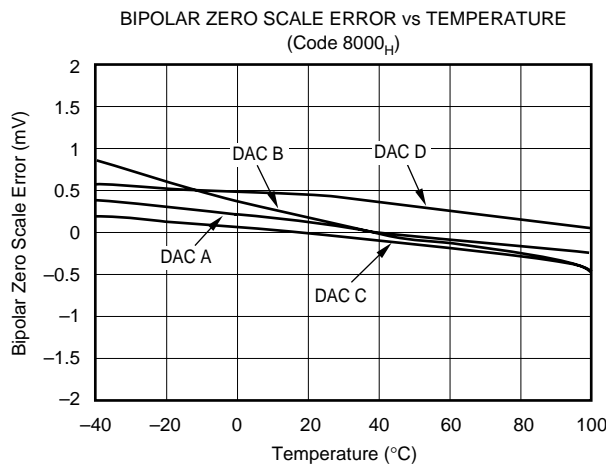
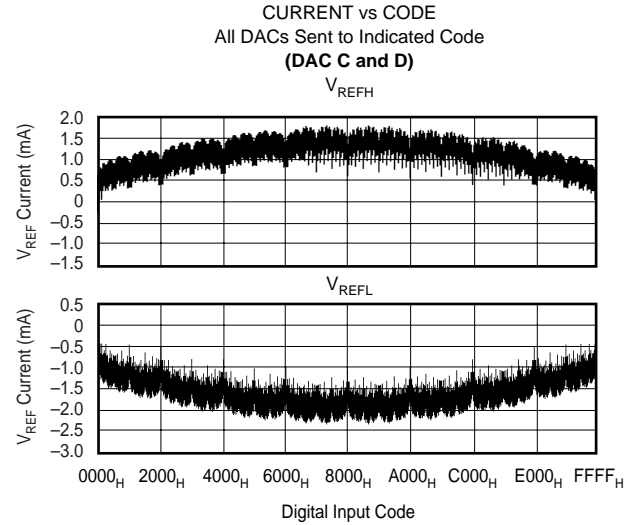
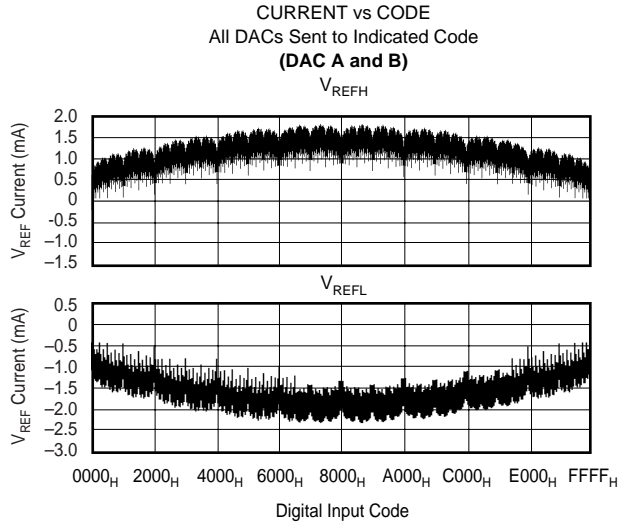

# TYPICAL PERFORMANCE CURVES: $V_{SS} = -15V$ (Cont.)

At  $T_A = +25^\circ C$ ,  $V_{DD} = +5V$ ,  $V_{CC} = +15V$ ,  $V_{SS} = -15V$ ,  $V_{REFH} = +10V$ , and  $V_{REFL} = -10V$ , representative unit, unless otherwise specified.

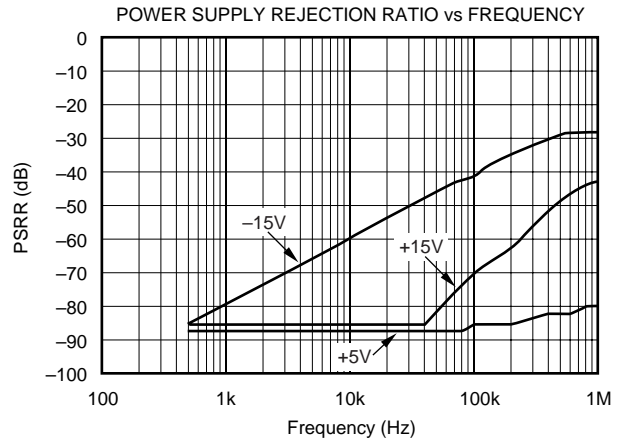
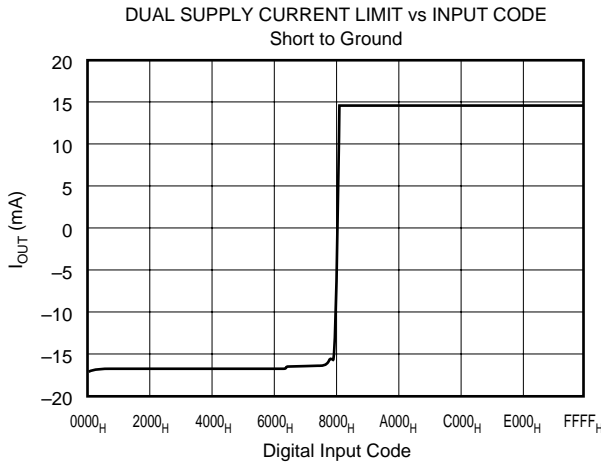
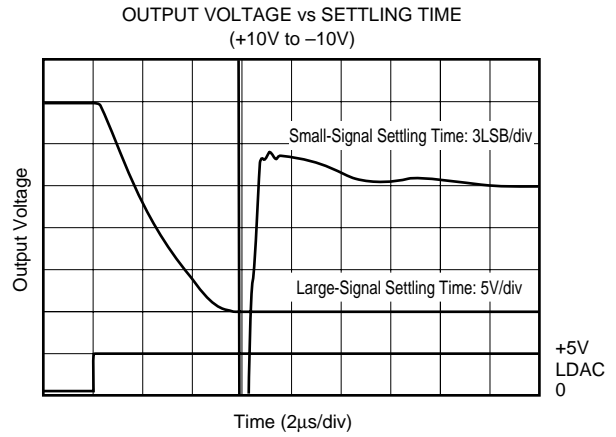
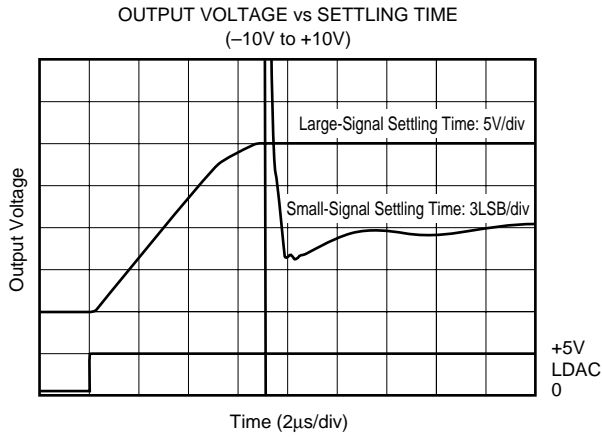
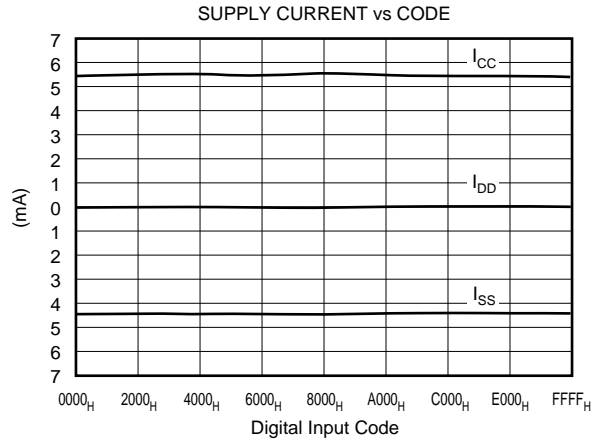
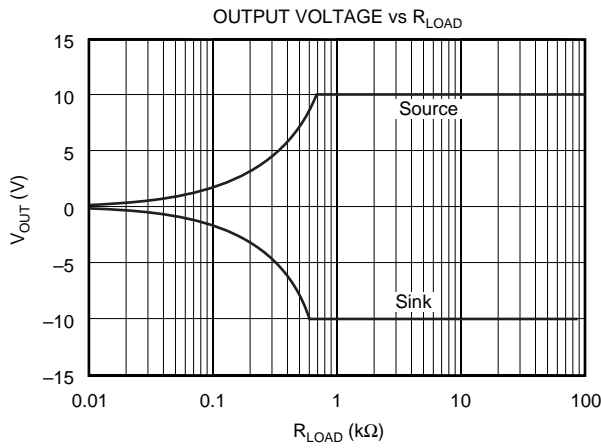

# TYPICAL PERFORMANCE CURVES: $V_{SS} = -15V$ (Cont.)

At  $T_A = +25^\circ C$ ,  $V_{DD} = +5V$ ,  $V_{CC} = +15V$ ,  $V_{SS} = -15V$ ,  $V_{REFH} = +10V$ , and  $V_{REFL} = -10V$ , representative unit, unless otherwise specified.

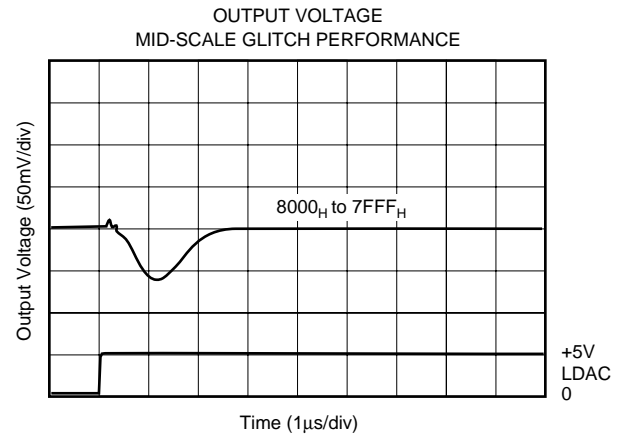
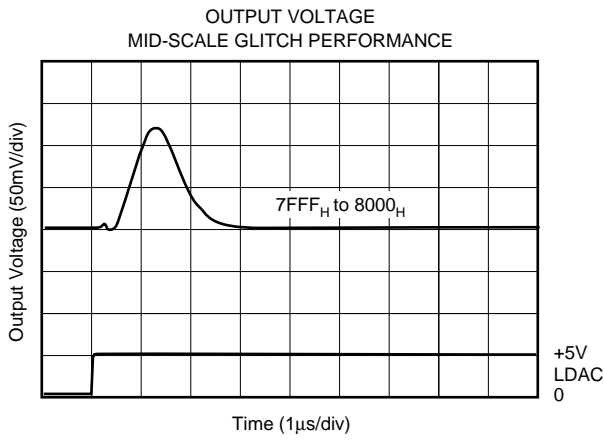

# THEORY OF OPERATION

The DAC7744 is a quad voltage output, 16-bit digital-to-analog converter (DAC). The architecture is an R-2R ladder configuration with the three MSB's segmented followed by an operational amplifier that serves as a buffer. Each DAC has its own R-2R ladder network, segmented MSBs and output op amp (see Figure 1). The minimum voltage output (zero scale) and maximum voltage output (full scale) are set

by the external voltage references ( $V_{REFL}$  and  $V_{REFH}$ , respectively). The digital input is a 16-bit parallel word and the DAC input registers offer a readback capability. The converters can be powered from either a single +15V supply or a dual  $\pm 15V$  supply. The device offers a reset function which immediately sets all DAC output voltages and DAC registers to mid-scale code 8000<sub>H</sub> or to zero scale, code 0000<sub>H</sub>. See Figures 2 and 3 for the basic operation of the DAC7744.

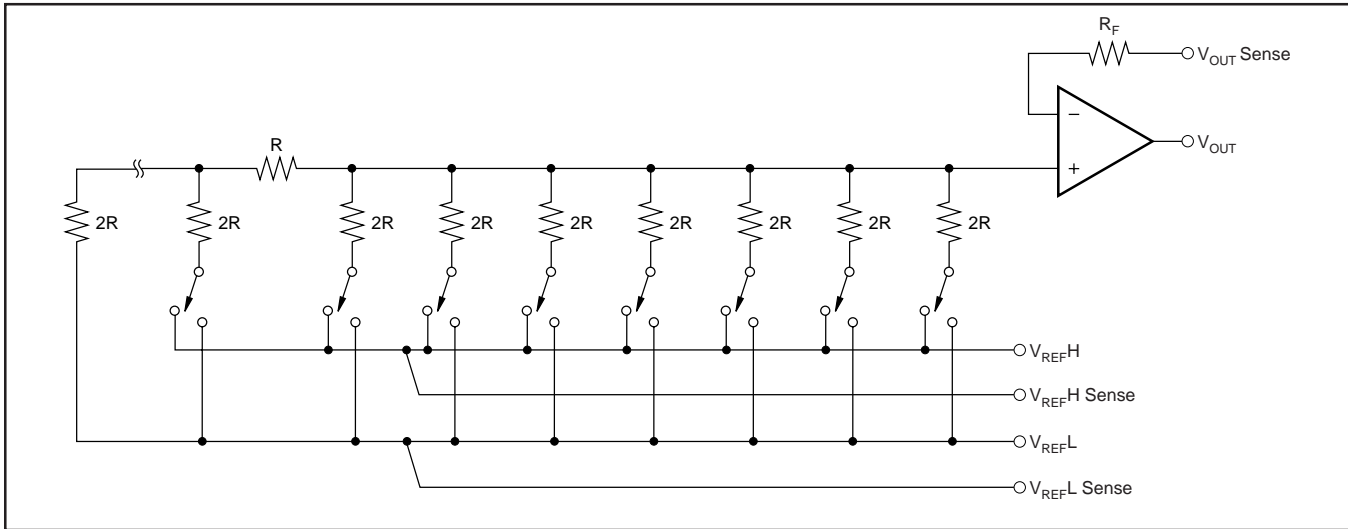

FIGURE 1. DAC7744 Architecture.

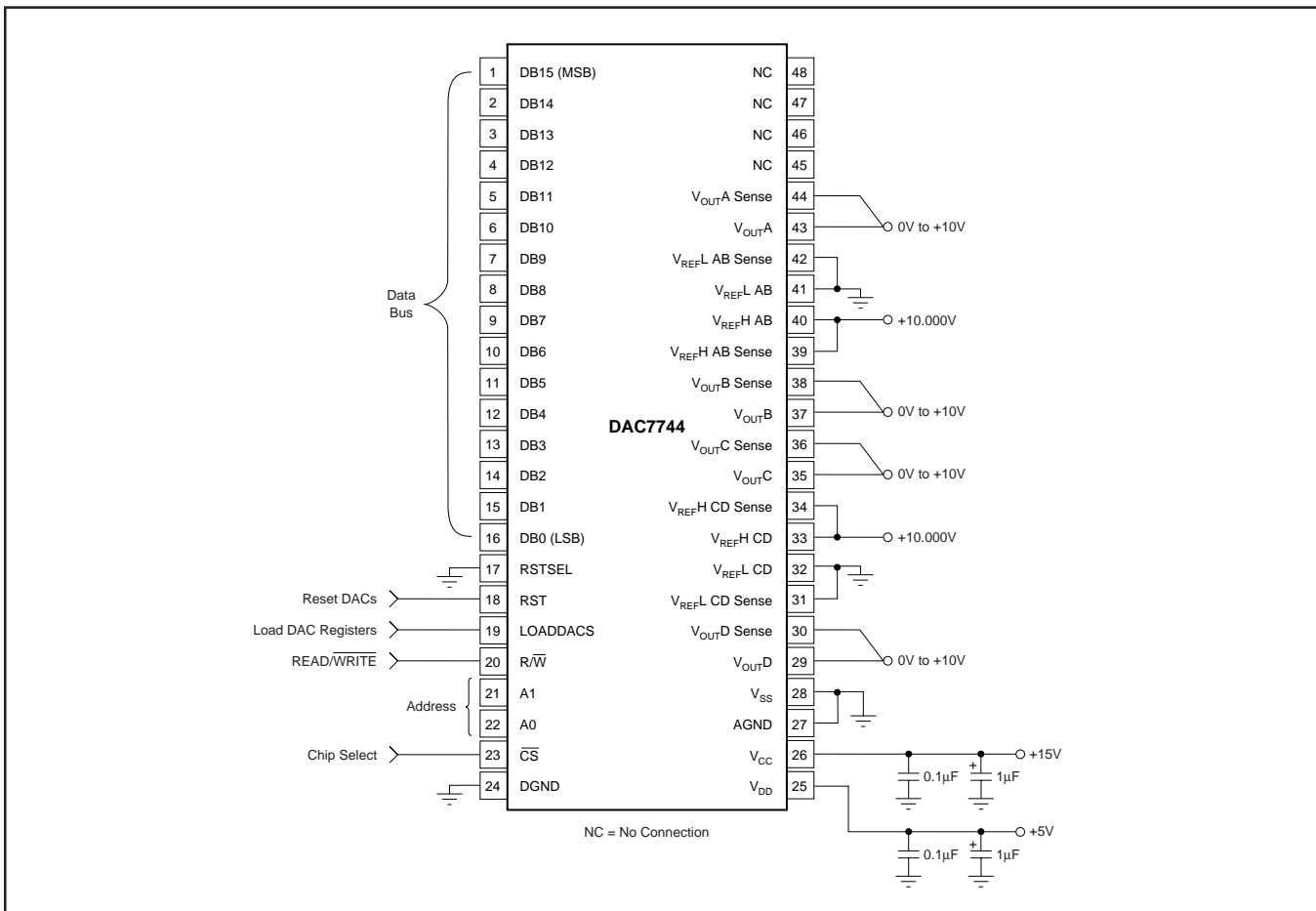

FIGURE 2. Basic Single-Supply Operation of the DAC7744.



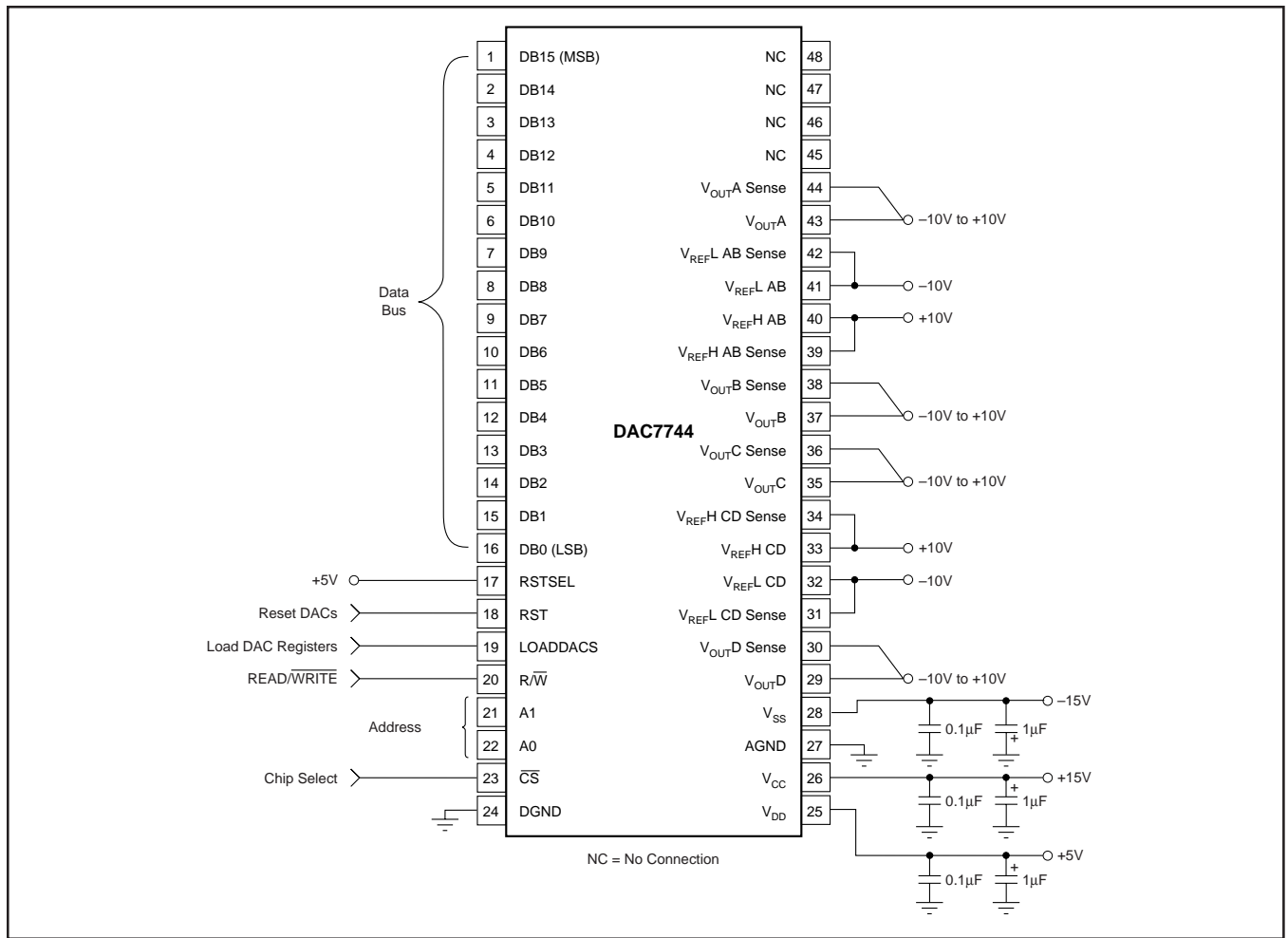

FIGURE 3. Basic Dual-Supply Operation of the DAC7744.

### ANALOG OUTPUTS

When  $V_{SS} = -15V$  (dual supply operation), the output amplifier can swing to within 4V of the supply rails, guaranteed over the  $-40^{\circ}C$  to  $+85^{\circ}C$  temperature range. With  $V_{SS} = 0V$  (single-supply operation), and with  $R_{LOAD}$  also connected to ground, the output can swing to ground. Care must also be taken when measuring the zero-scale error when  $V_{SS} = 0V$ . Since the output voltage cannot swing below ground, the output voltage may not change for the first few digital input codes (0000<sub>H</sub>, 0001<sub>H</sub>, 0002<sub>H</sub>, etc.), if the output amplifier has a negative offset. At the negative limit of  $-5mV$ , the first specified output starts at code 0021<sub>H</sub>.

Due to the high accuracy of these D/A converters, system design problems such as grounding and contact resistance become very important. A 16-bit converter with a 10V full-scale range has a 1LSB value of  $152\mu V$ . With a load current of 1mA, series wiring and connector resistance of only  $150m\Omega$  ( $R_{W2}$ ) will cause a voltage drop of  $150\mu V$ , as shown in Figure 4. To understand what this means in terms of a system layout, the resistivity of a typical 1 ounce copper-clad printed circuit board is  $1/2 m\Omega$  per square. For a 1mA load, a 20 milli-inch wide printed circuit conductor 6 inches long will result in a voltage drop of  $150\mu V$ .

The DAC7744 offers a force and sense output configuration for the high open-loop gain output amplifiers. This feature

allows the loop around the output amplifier to be closed at the load, thus ensuring an accurate output voltage, as shown in Figure 4.

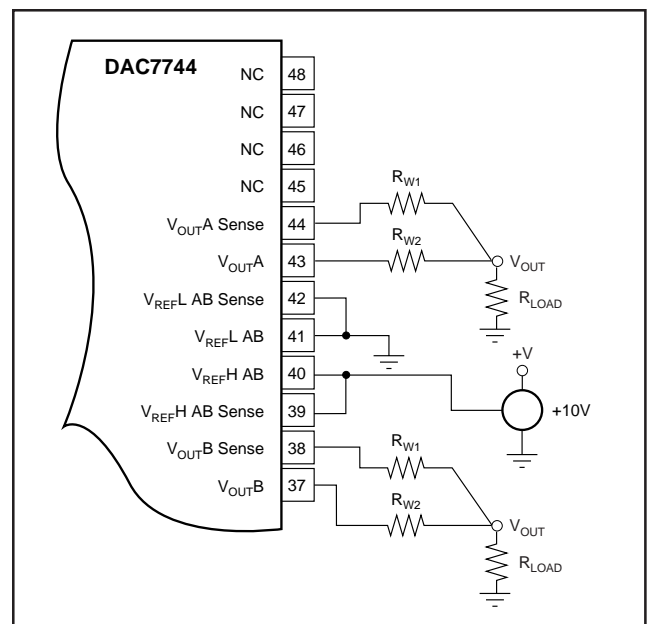

FIGURE 4. Analog Output Closed-Loop Configuration (1/2 DAC7744).  $R_W$  represents wiring resistances.

## REFERENCE INPUTS

The reference inputs,  $V_{REFL}$  and  $V_{REFH}$ , can be any voltage between  $V_{SS} + 4V$  and  $V_{CC} - 4V$ , provided that  $V_{REFH}$  is at least 1.25V greater than  $V_{REFL}$ . The minimum output of each DAC is equal to  $V_{REFL}$  plus a small offset voltage (essentially, the offset of the output op amp). The maximum output is equal to  $V_{REFH}$  plus a similar offset voltage. Note that  $V_{SS}$  (the negative power supply) must either be connected to ground or must be in the range of  $-14.25V$  to  $-15.75V$ . The voltage on  $V_{SS}$  sets several bias points within the converter. If  $V_{SS}$  is not in one of these two configurations, the bias values may be in error and proper operation of the device is not guaranteed.

The current into the  $V_{REFH}$  input and out of  $V_{REFL}$  depends on the DAC output voltages and can vary from a few

microamps to approximately 2.0mA. The reference input appears as a varying load to the reference. If the reference can sink or source the required current, a reference buffer is not required. The DAC7744 features a reference drive and sense connection such that the internal errors caused by the changing reference current and the circuit impedances can be minimized. Figures 5 through 12 show different reference configurations and the effect on the linearity and differential linearity.

The analog supplies (or the analog supplies and the reference power supplies) have to come up first. If the power supplies for the reference come up first, then the  $V_{CC}$  and  $V_{SS}$  supplies will be “powered from the reference via the ESD protection diode”, see page 4.

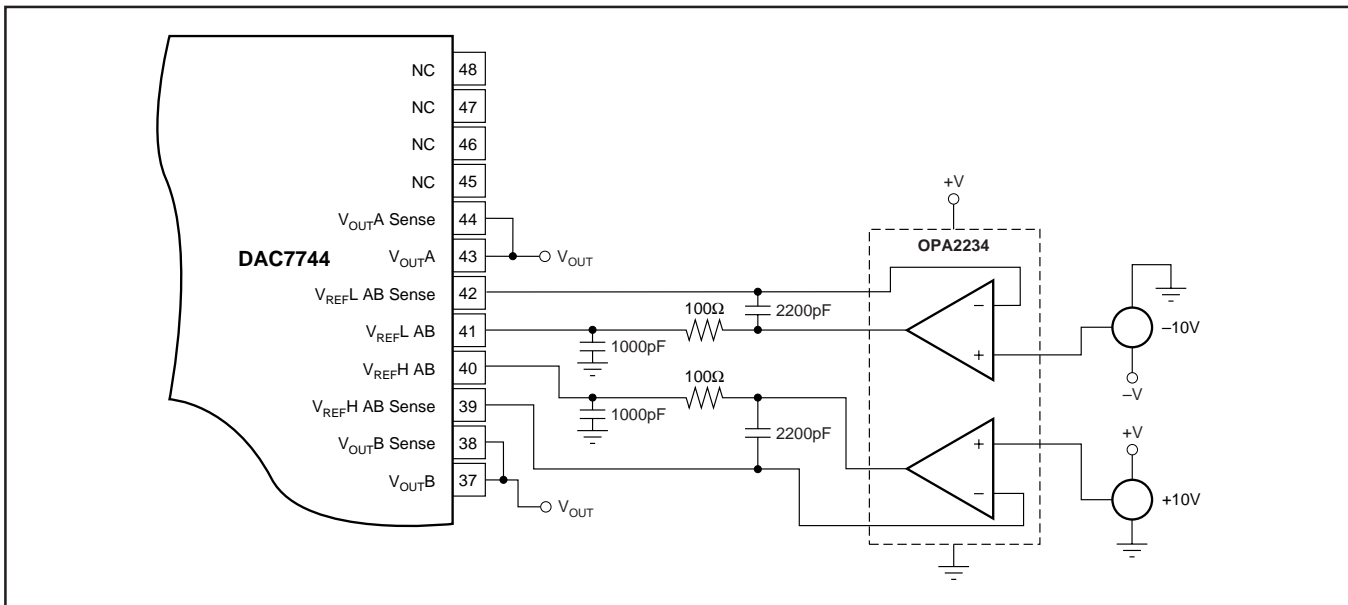

FIGURE 5. Dual Supply Configuration-Buffered References, used for Dual Supply Performance Curves (1/2 DAC7744).

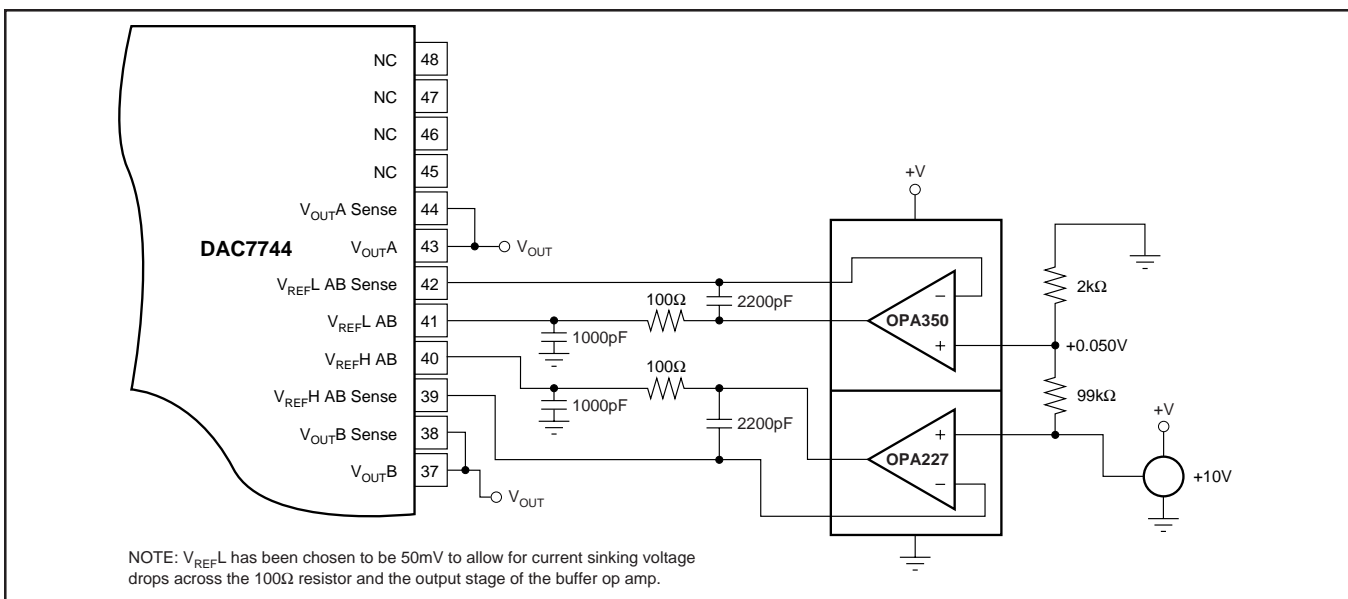

FIGURE 6. Single-Supply Buffered Reference with a Reference Low of 50mV Used for Single-Supply Performance Curves (1/2 DAC7744).

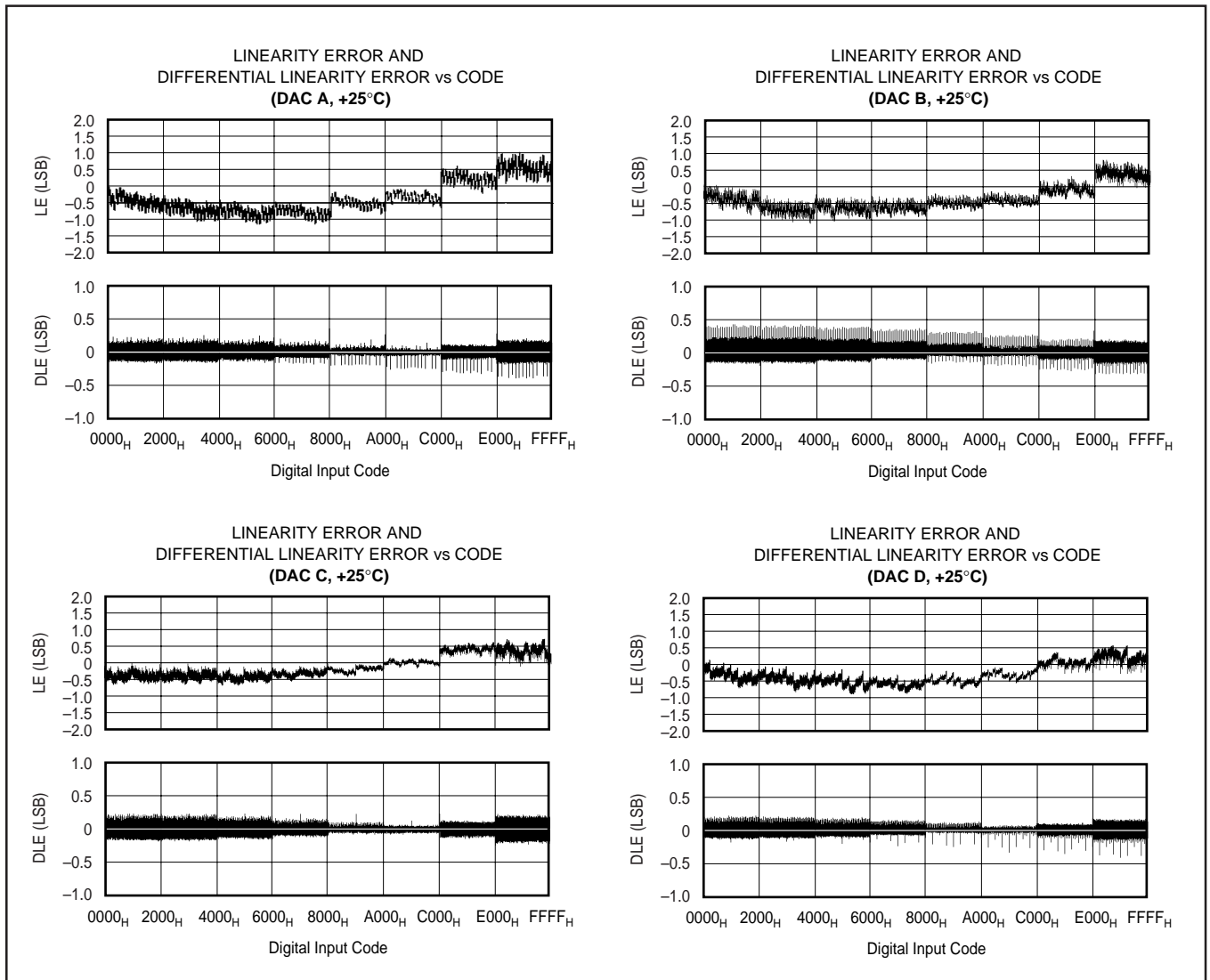

FIGURE 7. Integral Linearity and Differential Linearity Error Curves for Figure 8.

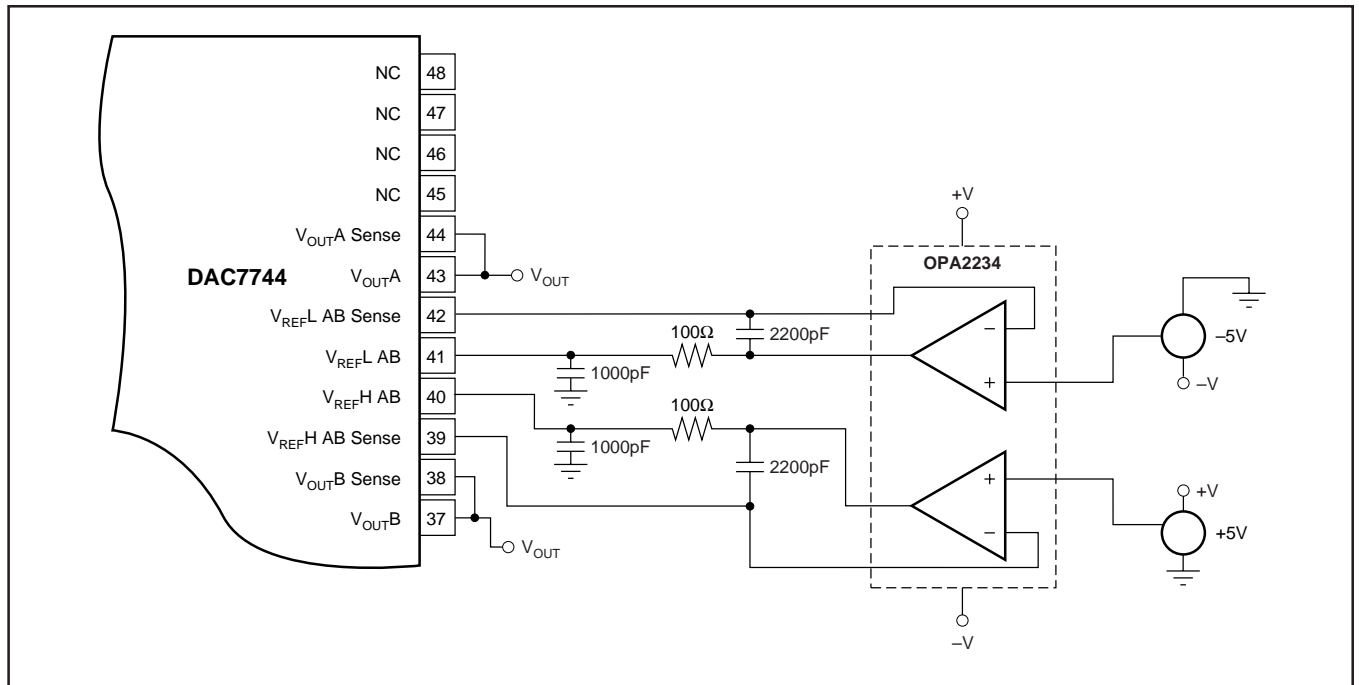

FIGURE 8. Dual-Supply Buffered Referenced with  $V_{REFL} = -5V$  and  $V_{REFH} = +5V$  (1/2 DAC7744).

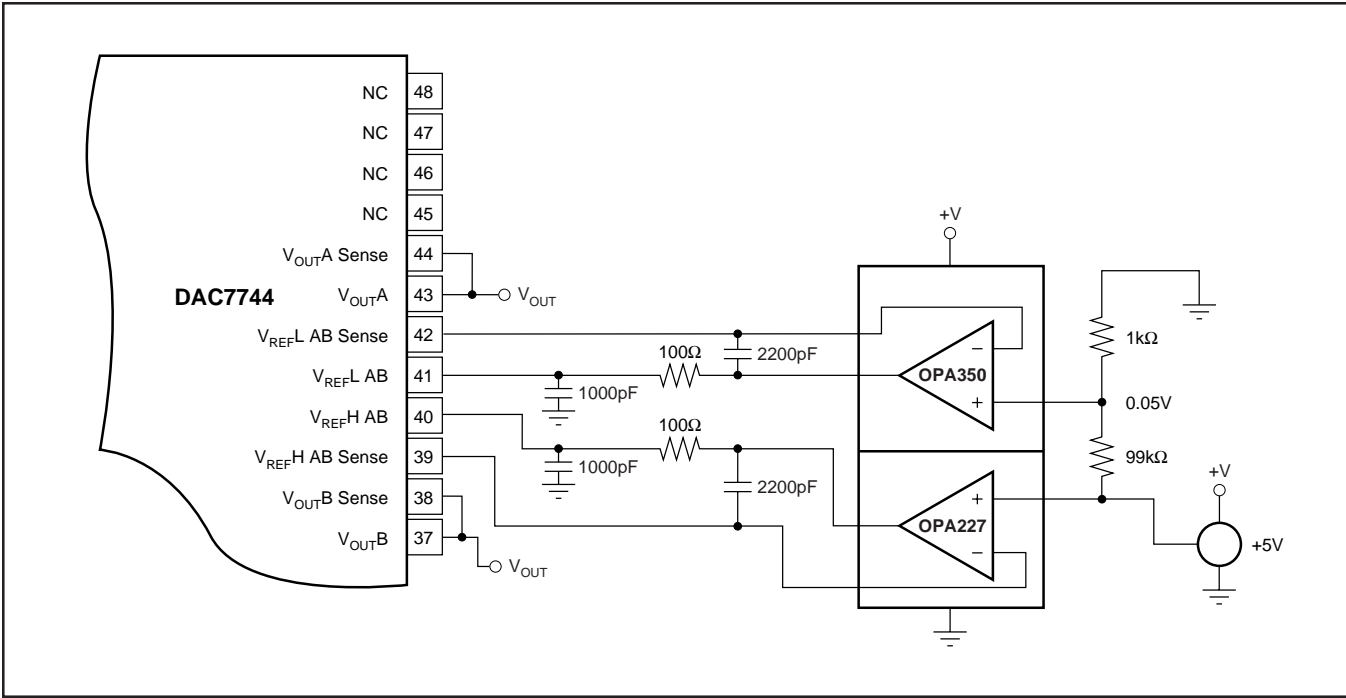

FIGURE 9. Single-Supply Buffered Reference with a Reference Low of 50mV and Reference High of +5V.

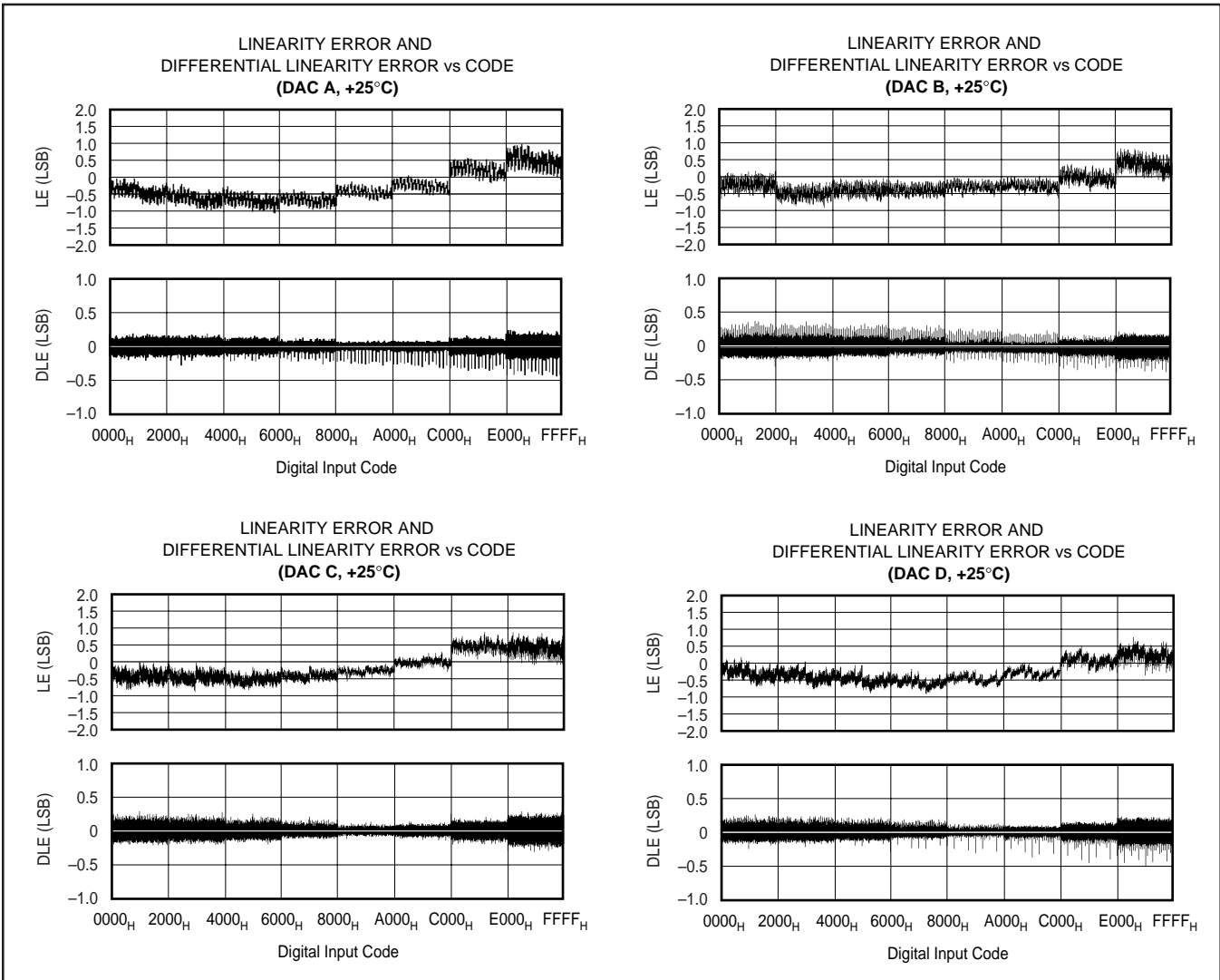

FIGURE 10. Integral Linearity and Differential Linearity Error Curves for Figure 9.

A1	A0	R/W	$\overline{CS}$	RST	RSTSEL	LOADDACS	INPUT REGISTER	DAC REGISTER	MODE	DAC
L	L	L	L	X	X	X	Write	Hold	Write Input	A
L	H	L	L	X	X	X	Write	Hold	Write Input	B
H	L	L	L	X	X	X	Write	Hold	Write Input	C
H	H	L	L	X	X	X	Write	Hold	Write Input	D
L	L	H	L	X	X	X	Read	Hold	Read Input	A
L	H	H	L	X	X	X	Read	Hold	Read Input	B
H	L	H	L	X	X	X	Read	Hold	Read Input	C
H	H	H	L	X	X	X	Read	Hold	Read Input	D
X	X	X	H	X	X	↑	Hold	Write	Update	All
X	X	X	H	X	X	H	Hold	Hold	Hold	All
X	X	X	X	↑	L	X		Reset to Zero	Reset to Zero	All
X	X	X	X	↑	H	X		Reset to Midscale	Reset to Midscale	All

TABLE I. DAC7744 Logic Truth Table.

## DIGITAL INTERFACE

Table I shows the basic control logic for the DAC7744. Note that each DAC register is edge triggered and not level triggered. When the LOADDACS signal is transitioned to HIGH, the digital word currently in the DAC register is latched. The first set of registers (the input registers) are triggered via the A0, A1, R/W, and  $\overline{CS}$  inputs. Only one of these registers is transparent at any given time.

The double-buffered architecture is designed mainly so that each DAC input register can be written to at any time and then all DAC voltages updated simultaneously by the rising edge of LOADDACS. It also allows a DAC input register to be written to at any point then the DAC output voltages can be synchronously changed via a trigger signal connected to LOADDACS.

## DIGITAL TIMING

Figure 11 and Table II provide detailed timing for the digital interface of the DAC7744.

## DIGITAL INPUT CODING

The DAC7744 input data is in Straight Binary format. The output voltage is given by Equation 1.

$$V_{OUT} = V_{REFL} + \frac{(V_{REFH} - V_{REFL}) \cdot N}{65,536} \quad (1)$$

where N is the digital input code. This equation does not include the effects of offset (zero scale) or gain (full scale) errors.

## DIGITALLY-PROGRAMMABLE CURRENT SOURCE

The DAC7744 offers a unique set of features that allows a wide range of flexibility in designing applications circuits such as programmable current sources. The DAC7744 offers both a differential reference input as well as an open-loop configuration around the output amplifier. The open-loop configuration around the output amplifier allows transistor to be placed within the loop to implement a digitally-programmable, uni-directional current source. The availability of a differential reference also allows programmability for both the full-scale and zero-scale currents. The output current is calculated as:

$$I_{OUT} = \left( \left( \frac{V_{REFH} - V_{REFL}}{R_{SENSE}} \right) \cdot \left( \frac{N}{65,536} \right) \right) + (V_{REFL} / R_{SENSE}) \quad (2)$$

Figure 12 shows a DAC7744 in a 4-to-20mA current output configuration. The output current can be determined by Equation 3:

$$I_{OUT} = \left( \left( \frac{5V - 1V}{250\Omega} \right) \cdot \left( \frac{N}{65,536} \right) \right) + \left( \frac{1V}{250\Omega} \right) \quad (3)$$

At full scale, the output current is 16mA plus the 4mA for the zero current. At zero scale, the output current is the offset current of 4mA (1V/250Ω).

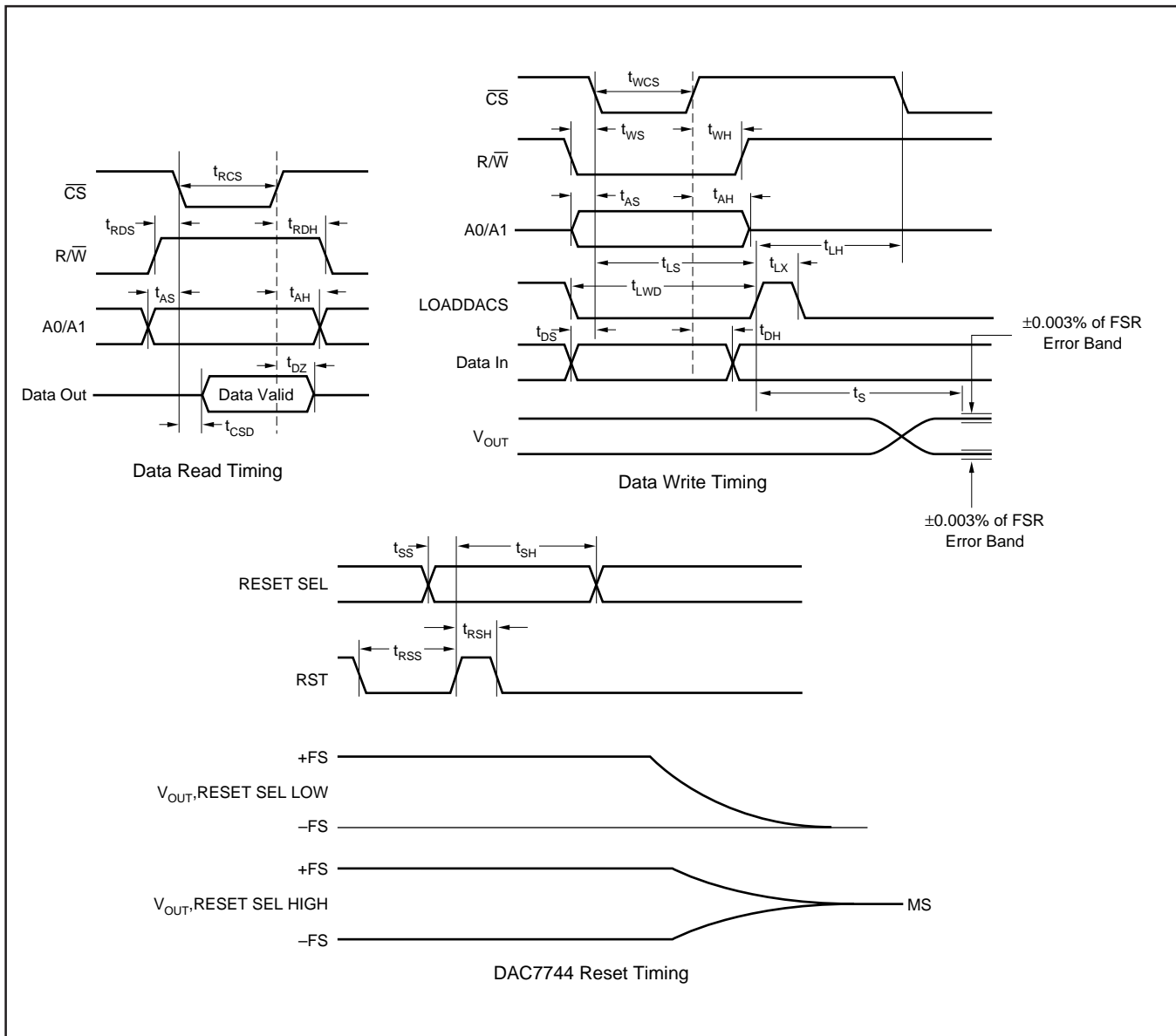

FIGURE 11. Digital Input and Output Timing.

SYMBOL	DESCRIPTION	MIN	TYP	MAX	UNITS
$t_{RCS}$	$\overline{CS}$ LOW for Read	100			ns
$t_{RDS}$	$R/\overline{W}$ HIGH to $\overline{CS}$ LOW	10			ns
$t_{RDH}$	$R/\overline{W}$ HIGH after $\overline{CS}$ HIGH	10			ns
$t_{DZ}$	$\overline{CS}$ HIGH to Data Bus in High Impedance	10			ns
$t_{CSD}$	$\overline{CS}$ LOW to Data Bus Valid		85	70	ns
$t_{WCS}$	$\overline{CS}$ LOW for Write	40		130	ns
$t_{WS}$	$R/\overline{W}$ LOW to $\overline{CS}$ LOW	0			ns
$t_{WH}$	$R/\overline{W}$ LOW after $\overline{CS}$ HIGH	10			ns
$t_{AS}$	Address Valid to $\overline{CS}$ LOW	0			ns
$t_{AH}$	Address Valid after $\overline{CS}$ HIGH	15			ns
$t_{LS}$	$\overline{CS}$ LOW to $LOADDACS$ HIGH	40			ns
$t_{LH}$	$\overline{CS}$ LOW after $LOADDACS$ HIGH	80			ns
$t_{LX}$	$LOADDACS$ HIGH	40			ns
$t_{DS}$	Data Valid to $\overline{CS}$ LOW	0			ns
$t_{DH}$	Data Valid after $\overline{CS}$ HIGH	15			ns
$t_{LWD}$	$LOADDACS$ LOW	40			ns
$t_{SS}$	RSTSEL Valid Before RESET HIGH	0			ns
$t_{SH}$	RSTSEL Valid After RESET HIGH	120			ns
$t_{RSS}$	RESET LOW Before RESET HIGH	10			ns
$t_{RSH}$	RESET LOW After RESET HIGH	10			ns
$t_S$	Settling Time			11	$\mu$ s

TABLE II. Timing Specifications ( $T_A = -40^\circ\text{C}$  to  $+85^\circ\text{C}$ ).

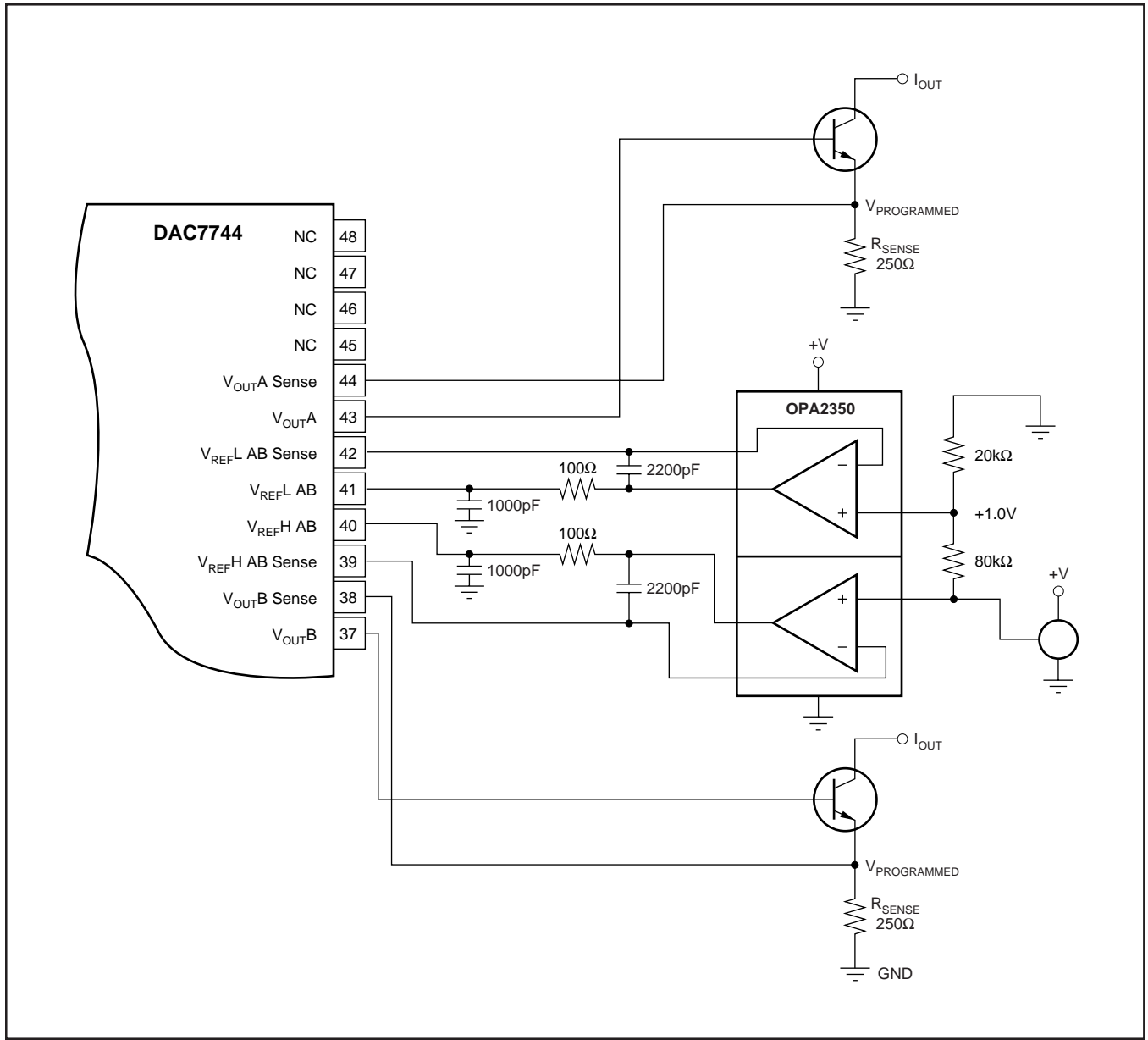

FIGURE 12. 4-to-20mA Digitally-Controlled Current Source (1/2 DAC7744).

**PACKAGING INFORMATION**

Orderable Device	Status <sup>(1)</sup>	Package Type	Package Drawing	Pins	Package Qty	Eco Plan <sup>(2)</sup>	Lead/Ball Finish	MSL Peak Temp <sup>(3)</sup>
DAC7744E	ACTIVE	SSOP	DL	48	30	Green (RoHS & no Sb/Br)	CU NIPDAU	Level-3-260C-168 HR
DAC7744E/1K	ACTIVE	SSOP	DL	48	1000	Green (RoHS & no Sb/Br)	CU NIPDAU	Level-3-260C-168 HR
DAC7744E/1KG4	ACTIVE	SSOP	DL	48	1000	Green (RoHS & no Sb/Br)	CU NIPDAU	Level-3-260C-168 HR
DAC7744EB	ACTIVE	SSOP	DL	48	30	Green (RoHS & no Sb/Br)	CU NIPDAU	Level-3-260C-168 HR
DAC7744EB/1K	ACTIVE	SSOP	DL	48	1000	Green (RoHS & no Sb/Br)	CU NIPDAU	Level-3-260C-168 HR
DAC7744EB/1KG4	ACTIVE	SSOP	DL	48	1000	Green (RoHS & no Sb/Br)	CU NIPDAU	Level-3-260C-168 HR
DAC7744EBG4	ACTIVE	SSOP	DL	48	30	Green (RoHS & no Sb/Br)	CU NIPDAU	Level-3-260C-168 HR
DAC7744EC	ACTIVE	SSOP	DL	48	30	Green (RoHS & no Sb/Br)	CU NIPDAU	Level-3-260C-168 HR
DAC7744EC/1K	ACTIVE	SSOP	DL	48	1000	Green (RoHS & no Sb/Br)	CU NIPDAU	Level-3-260C-168 HR
DAC7744EC/1KG4	ACTIVE	SSOP	DL	48	1000	Green (RoHS & no Sb/Br)	CU NIPDAU	Level-3-260C-168 HR
DAC7744ECG4	ACTIVE	SSOP	DL	48	30	Green (RoHS & no Sb/Br)	CU NIPDAU	Level-3-260C-168 HR
DAC7744EG4	ACTIVE	SSOP	DL	48	30	Green (RoHS & no Sb/Br)	CU NIPDAU	Level-3-260C-168 HR

<sup>(1)</sup> The marketing status values are defined as follows:

**ACTIVE:** Product device recommended for new designs.

**LIFEBUY:** TI has announced that the device will be discontinued, and a lifetime-buy period is in effect.

**NRND:** Not recommended for new designs. Device is in production to support existing customers, but TI does not recommend using this part in a new design.

**PREVIEW:** Device has been announced but is not in production. Samples may or may not be available.

**OBSOLETE:** TI has discontinued the production of the device.

<sup>(2)</sup> Eco Plan - The planned eco-friendly classification: Pb-Free (RoHS), Pb-Free (RoHS Exempt), or Green (RoHS & no Sb/Br) - please check <http://www.ti.com/productcontent> for the latest availability information and additional product content details.

**TBD:** The Pb-Free/Green conversion plan has not been defined.

**Pb-Free (RoHS):** TI's terms "Lead-Free" or "Pb-Free" mean semiconductor products that are compatible with the current RoHS requirements for all 6 substances, including the requirement that lead not exceed 0.1% by weight in homogeneous materials. Where designed to be soldered at high temperatures, TI Pb-Free products are suitable for use in specified lead-free processes.

**Pb-Free (RoHS Exempt):** This component has a RoHS exemption for either 1) lead-based flip-chip solder bumps used between the die and package, or 2) lead-based die adhesive used between the die and leadframe. The component is otherwise considered Pb-Free (RoHS compatible) as defined above.

**Green (RoHS & no Sb/Br):** TI defines "Green" to mean Pb-Free (RoHS compatible), and free of Bromine (Br) and Antimony (Sb) based flame retardants (Br or Sb do not exceed 0.1% by weight in homogeneous material)

<sup>(3)</sup> MSL, Peak Temp. -- The Moisture Sensitivity Level rating according to the JEDEC industry standard classifications, and peak solder temperature.

**Important Information and Disclaimer:** The information provided on this page represents TI's knowledge and belief as of the date that it is provided. TI bases its knowledge and belief on information provided by third parties, and makes no representation or warranty as to the accuracy of such information. Efforts are underway to better integrate information from third parties. TI has taken and continues to take reasonable steps to provide representative and accurate information but may not have conducted destructive testing or chemical analysis on incoming materials and chemicals. TI and TI suppliers consider certain information to be proprietary, and thus CAS numbers and other limited information may not be available for release.



In no event shall TI's liability arising out of such information exceed the total purchase price of the TI part(s) at issue in this document sold by TI to Customer on an annual basis.

**TAPE AND REEL INFORMATION**



**QUADRANT ASSIGNMENTS FOR PIN 1 ORIENTATION IN TAPE**



\*All dimensions are nominal

Device	Package Type	Package Drawing	Pins	SPQ	Reel Diameter (mm)	Reel Width W1 (mm)	A0 (mm)	B0 (mm)	K0 (mm)	P1 (mm)	W (mm)	Pin1 Quadrant
DAC7744E/1K	SSOP	DL	48	1000	330.0	32.4	11.35	16.2	3.1	16.0	32.0	Q1
DAC7744EB/1K	SSOP	DL	48	1000	330.0	32.4	11.35	16.2	3.1	16.0	32.0	Q1
DAC7744EC/1K	SSOP	DL	48	1000	330.0	32.4	11.35	16.2	3.1	16.0	32.0	Q1

**TAPE AND REEL BOX DIMENSIONS**

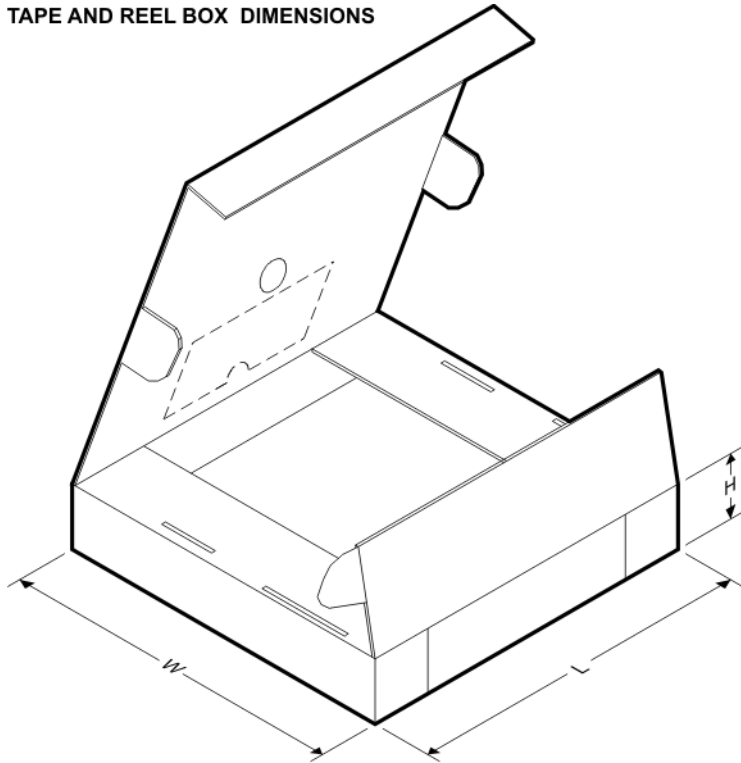

\*All dimensions are nominal

Device	Package Type	Package Drawing	Pins	SPQ	Length (mm)	Width (mm)	Height (mm)
DAC7744E/1K	SSOP	DL	48	1000	346.0	346.0	49.0
DAC7744EB/1K	SSOP	DL	48	1000	346.0	346.0	49.0
DAC7744EC/1K	SSOP	DL	48	1000	346.0	346.0	49.0

## IMPORTANT NOTICE

Texas Instruments Incorporated and its subsidiaries (TI) reserve the right to make corrections, modifications, enhancements, improvements, and other changes to its products and services at any time and to discontinue any product or service without notice. Customers should obtain the latest relevant information before placing orders and should verify that such information is current and complete. All products are sold subject to TI's terms and conditions of sale supplied at the time of order acknowledgment.

TI warrants performance of its hardware products to the specifications applicable at the time of sale in accordance with TI's standard warranty. Testing and other quality control techniques are used to the extent TI deems necessary to support this warranty. Except where mandated by government requirements, testing of all parameters of each product is not necessarily performed.

TI assumes no liability for applications assistance or customer product design. Customers are responsible for their products and applications using TI components. To minimize the risks associated with customer products and applications, customers should provide adequate design and operating safeguards.

TI does not warrant or represent that any license, either express or implied, is granted under any TI patent right, copyright, mask work right, or other TI intellectual property right relating to any combination, machine, or process in which TI products or services are used. Information published by TI regarding third-party products or services does not constitute a license from TI to use such products or services or a warranty or endorsement thereof. Use of such information may require a license from a third party under the patents or other intellectual property of the third party, or a license from TI under the patents or other intellectual property of TI.

Reproduction of TI information in TI data books or data sheets is permissible only if reproduction is without alteration and is accompanied by all associated warranties, conditions, limitations, and notices. Reproduction of this information with alteration is an unfair and deceptive business practice. TI is not responsible or liable for such altered documentation. Information of third parties may be subject to additional restrictions.

Resale of TI products or services with statements different from or beyond the parameters stated by TI for that product or service voids all express and any implied warranties for the associated TI product or service and is an unfair and deceptive business practice. TI is not responsible or liable for any such statements.

TI products are not authorized for use in safety-critical applications (such as life support) where a failure of the TI product would reasonably be expected to cause severe personal injury or death, unless officers of the parties have executed an agreement specifically governing such use. Buyers represent that they have all necessary expertise in the safety and regulatory ramifications of their applications, and acknowledge and agree that they are solely responsible for all legal, regulatory and safety-related requirements concerning their products and any use of TI products in such safety-critical applications, notwithstanding any applications-related information or support that may be provided by TI. Further, Buyers must fully indemnify TI and its representatives against any damages arising out of the use of TI products in such safety-critical applications.

TI products are neither designed nor intended for use in military/aerospace applications or environments unless the TI products are specifically designated by TI as military-grade or "enhanced plastic." Only products designated by TI as military-grade meet military specifications. Buyers acknowledge and agree that any such use of TI products which TI has not designated as military-grade is solely at the Buyer's risk, and that they are solely responsible for compliance with all legal and regulatory requirements in connection with such use.

TI products are neither designed nor intended for use in automotive applications or environments unless the specific TI products are designated by TI as compliant with ISO/TS 16949 requirements. Buyers acknowledge and agree that, if they use any non-designated products in automotive applications, TI will not be responsible for any failure to meet such requirements.

Following are URLs where you can obtain information on other Texas Instruments products and application solutions:

### Products

Amplifiers	<a href="http://amplifier.ti.com">amplifier.ti.com</a>
Data Converters	<a href="http://dataconverter.ti.com">dataconverter.ti.com</a>
DSP	<a href="http://dsp.ti.com">dsp.ti.com</a>
Clocks and Timers	<a href="http://www.ti.com/clocks">www.ti.com/clocks</a>
Interface	<a href="http://interface.ti.com">interface.ti.com</a>
Logic	<a href="http://logic.ti.com">logic.ti.com</a>
Power Mgmt	<a href="http://power.ti.com">power.ti.com</a>
Microcontrollers	<a href="http://microcontroller.ti.com">microcontroller.ti.com</a>
RFID	<a href="http://www.ti-rfid.com">www.ti-rfid.com</a>
RF/IF and ZigBee® Solutions	<a href="http://www.ti.com/lprf">www.ti.com/lprf</a>

### Applications

Audio	<a href="http://www.ti.com/audio">www.ti.com/audio</a>
Automotive	<a href="http://www.ti.com/automotive">www.ti.com/automotive</a>
Broadband	<a href="http://www.ti.com/broadband">www.ti.com/broadband</a>
Digital Control	<a href="http://www.ti.com/digitalcontrol">www.ti.com/digitalcontrol</a>
Medical	<a href="http://www.ti.com/medical">www.ti.com/medical</a>
Military	<a href="http://www.ti.com/military">www.ti.com/military</a>
Optical Networking	<a href="http://www.ti.com/opticalnetwork">www.ti.com/opticalnetwork</a>
Security	<a href="http://www.ti.com/security">www.ti.com/security</a>
Telephony	<a href="http://www.ti.com/telephony">www.ti.com/telephony</a>
Video & Imaging	<a href="http://www.ti.com/video">www.ti.com/video</a>
Wireless	<a href="http://www.ti.com/wireless">www.ti.com/wireless</a>

Mailing Address: Texas Instruments, Post Office Box 655303, Dallas, Texas 75265  
Copyright © 2008, Texas Instruments Incorporated