

–36-V, –1-A, Ultralow-Noise Negative Voltage Regulator

FEATURES

- **Input Voltage Range:** –3 V to –36 V
- **Noise:**
 - 16 μV_{RMS} (10 Hz to 100 kHz)
- **Power-Supply Ripple Rejection:**
 - 72 dB (10 kHz)
- **Adjustable Output:** –1.18 V to –33 V
- **Maximum Output Current:** 1 A
- **Stable with Ceramic Capacitors $\geq 10 \mu\text{F}$**
- **Built-In Current-Limit and Thermal Shutdown Protection**
- **Available in an External Heatsink-Capable, High Thermal Performance TO-220 Package**
- **Operating Temperature Range:** –40°C to +125°C

APPLICATIONS

- **Supply Rails for Op Amps, DACs, ADCs, and Other High-Precision Analog Circuitry**
- **Audio**
- **Post DC/DC Converter Regulation and Ripple Filtering**
- **Test and Measurement**
- **Medical**
- **Industrial Instrumentation**
- **Base Stations and Telecom Infrastructure**
- **12-V and 24-V Industrial Buses**

KC PACKAGE
TO-220-7
(Top View)

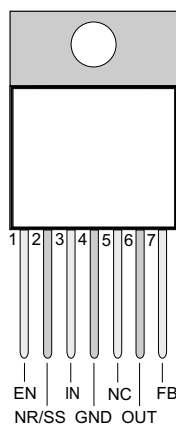

RGW PACKAGE
5-mm \times 5-mm QFN-20
(Top View)

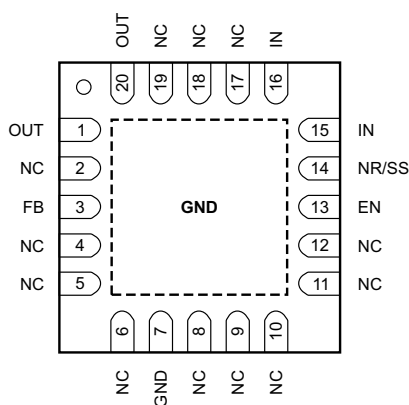

NOTE: RGW package is product preview.



Please be aware that an important notice concerning availability, standard warranty, and use in critical applications of Texas Instruments semiconductor products and disclaimers thereto appears at the end of this data sheet.

All trademarks are the property of their respective owners.

UNLESS OTHERWISE NOTED this document contains PRODUCTION DATA information current as of publication date. Products conform to specifications per the terms of Texas Instruments standard warranty. Production processing does not necessarily include testing of all parameters.

DESCRIPTION

The TPS7A33 series of linear regulators are negative voltage (–36 V), ultralow-noise (16 μV_{RMS} , 72 dB PSRR) linear regulators capable of sourcing a maximum load of 1 A.

The TPS7A33 series include a complementary metal oxide semiconductor (CMOS) logic-level-compatible enable pin (EN) to allow for user-customizable power management schemes. Other features available include built-in current limit and thermal shutdown features to protect the device and system during fault conditions.

The TPS7A33 family is designed using bipolar technology primarily for high-accuracy, high-precision instrumentation applications, where clean voltage rails are critical to maximize system performance. This feature makes it ideal to power operational amplifiers, analog-to-digital converters (ADCs), digital-to-analog converters (DACs), and other high-performance analog circuitry.

In addition, the TPS7A33 family of linear regulators is suitable for post dc-dc converter regulation. By filtering out the output voltage ripple inherent to dc-dc switching conversion, maximum system performance is ensured in sensitive instrumentation, medical, test and measurement, audio, and RF applications.

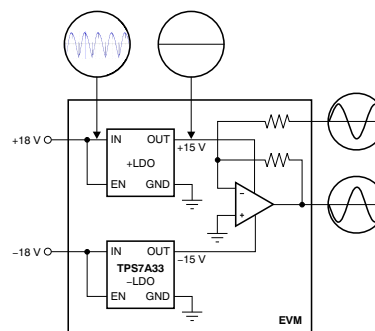

Typical Application: Post DC/DC Converter Regulation for High-Performance Analog Circuitry



This integrated circuit can be damaged by ESD. Texas Instruments recommends that all integrated circuits be handled with appropriate precautions. Failure to observe proper handling and installation procedures can cause damage.

ESD damage can range from subtle performance degradation to complete device failure. Precision integrated circuits may be more susceptible to damage because very small parametric changes could cause the device not to meet its published specifications.

ORDERING INFORMATION⁽¹⁾

PRODUCT	V _{OUT}
TPS7A33xyyyz	XX is nominal output voltage (01 = Adjustable). ⁽²⁾ YYY is package designator. Z is package quantity.

(1) For the most current package and ordering information see the Package Option Addendum at the end of this document, or visit the device product folder on www.ti.com.

(2) For fixed –1.2-V operation, tie FB to OUT.

ABSOLUTE MAXIMUM RATINGS⁽¹⁾

Over operating free-air temperature range $-40^{\circ}\text{C} \leq T_J \leq +125^{\circ}\text{C}$, unless otherwise noted.

		VALUE		UNIT
		MIN	MAX	
Voltage	IN pin to GND pin	–36	+0.3	V
	OUT pin to GND pin	–33	+0.3	V
	OUT pin to IN pin	–0.3	+36	V
	FB pin to GND pin	–2	+0.3	V
	FB pin to IN pin	–0.3	+36	V
	EN pin to GND pin	–36	+10	V
	NR/SS pin to IN pin	–0.3	+36	V
	NR/SS pin to GND pin	–2	+0.3	V
Current	Peak output	Internally limited		
Temperature	Operating virtual junction, T _J , absolute maximum range ⁽²⁾	–40	+150	°C
	Storage, T _{stg}	–65	+150	°C
Electrostatic discharge rating	Human body model (HBM)		1	kV
	Charged device model (CDM)		500	V

(1) Stresses beyond those listed under *Absolute Maximum Ratings* may cause permanent damage to the device. These are stress ratings only, and functional operation of the device at these or any other conditions beyond those indicated is not implied. Exposure to absolute-maximum rated conditions for extended periods may affect device reliability.

(2) No permanent damage will occur to the part operating within this range though electrical performance is not ensured outside the operating free-air temperature range.

THERMAL INFORMATION

THERMAL METRIC ⁽¹⁾		TPS7A33		UNITS
		KC (TO-220)	RGW (QFN) ⁽²⁾	
		7 PINS	20 PINS	
θ_{JA}	Junction-to-ambient thermal resistance	31.2	30.5	°C/W
$\theta_{JC(top)}$	Junction-to-case(top) thermal resistance	40.0	27.6	
θ_{JB}	Junction-to-board thermal resistance	17.4	N/A	
Ψ_{JT}	Junction-to-top characterization parameter	6.4	0.37	
Ψ_{JB}	Junction-to-board characterization parameter	17.2	10.6	
$\theta_{JC(bottom)}$	Junction-to-case(bottom) thermal resistance	0.8	4.1	

(1) For more information about traditional and new thermal metrics, see the *IC Package Thermal Metrics* application report, [SPRA953](http://www.ti.com/lit/zip/Spra953).

(2) The RGW package is product preview.

ELECTRICAL CHARACTERISTICS⁽¹⁾

At $-40^{\circ}\text{C} \leq T_J \leq +125^{\circ}\text{C}$, $|V_{IN}| = |V_{OUT(NOM)}| + 1.0\text{ V}$ or $|V_{IN}| = 3.0\text{ V}$ (whichever is greater), $V_{EN} = V_{IN}$, $I_{OUT} = 1\text{ mA}$, $C_{IN} = 10\text{ }\mu\text{F}$, $C_{OUT} = 10\text{ }\mu\text{F}$, $C_{NR/SS} = 0\text{ nF}$, and FB tied to OUT, unless otherwise noted.

PARAMETER	TEST CONDITIONS	TPS7A33			UNIT
		MIN	TYP	MAX	
V_{IN} Input voltage range		-35.0		-3.0	V
V_{REF} Internal reference	$T_J = +25^{\circ}\text{C}$, $V_{FB} = V_{REF}$	-1.192	-1.175	-1.157	V
V_{UVLO} Under-voltage lockout threshold			-2.0		V
V_{OUT}	Output voltage range ⁽²⁾	$ V_{IN} \geq V_{OUT(NOM)} + 1.0\text{ V}$		V_{REF}	V
	Nominal accuracy	$T_J = +25^{\circ}\text{C}$, $ V_{IN} = V_{OUT(NOM)} + 0.5\text{ V}$		1.5	% V_{OUT}
	Overall accuracy	$5.0\text{ V} \leq V_{IN} \leq 35\text{ V}$ $1\text{ mA} \leq I_{OUT} \leq 1\text{ A}$		± 1.0	
$ V_{OUT(NOM)} + 1.0\text{ V} \leq V_{IN} \leq 35\text{ V}$ $1\text{ mA} \leq I_{OUT} \leq 1\text{ A}$		-2.5	2.5	% V_{OUT}	
$\Delta V_{O(\Delta V)}$ Line regulation	$ V_{OUT(NOM)} + 1.0\text{ V} \leq V_{IN} \leq 35\text{ V}$		0.14		% V_{OUT}
$\Delta V_{O(\Delta I)}$ Load regulation	$1\text{ mA} \leq I_{OUT} \leq 1\text{ A}$		0.4		% V_{OUT}
$ V_{DO} $ Dropout voltage	$V_{IN} = 95\% V_{OUT(NOM)}$, $I_{OUT} = 500\text{ mA}$		290		mV
	$V_{IN} = 95\% V_{OUT(NOM)}$, $I_{OUT} = 1\text{ A}$		325	800	mV
I_{LIM} Current limit	$V_{OUT} = 90\% V_{OUT(NOM)}$		1900		mA
I_{GND} Ground current	$I_{OUT} = 0\text{ mA}$		210	350	μA
	$I_{OUT} = 500\text{ mA}$		5		mA
$ I_{SHDN} $ Shutdown supply current	$V_{EN} = +0.4\text{ V}$		1.0	3.0	μA
	$V_{EN} = -0.4\text{ V}$		1.0	3.0	μA
I_{FB} Feedback current ⁽³⁾			14	100	nA
$ I_{EN} $ Enable current	$V_{EN} = V_{IN} = V_{OUT(NOM)} + 1.0\text{ V}$		0.48	1.0	μA
	$V_{IN} = V_{EN} = -35\text{ V}$		0.51	1.0	μA
	$V_{IN} = -35\text{ V}$, $V_{EN} = +10\text{ V}$		0.50	1.0	μA
V_{+EN_HI} Positive enable high-level voltage		2.0		10	V
V_{+EN_LO} Positive enable low-level voltage		0		0.4	V
V_{-EN_HI} Negative enable high-level voltage		V_{IN}		-2.0	V
V_{-EN_LO} Negative enable low-level voltage		-0.4		0	V
V_n Output noise voltage	$V_{IN} = -3\text{ V}$, $V_{OUT(NOM)} = V_{REF}$, $C_{OUT} = 22\text{ }\mu\text{F}$, $C_{NR/SS} = 10\text{ nF}$, $BW = 10\text{ Hz to }100\text{ kHz}$		16		μV_{RMS}
PSRR Power-supply rejection ratio	$V_{IN} = -6.2\text{ V}$, $V_{OUT(NOM)} = -5\text{ V}$, $C_{OUT} = 22\text{ }\mu\text{F}$, $C_{NR/SS} = 10\text{ nF}$, C_{FF} ⁽⁴⁾ = 10 nF , $f = 10\text{ kHz}$		72		dB
T_{SD} Thermal shutdown temperature	Shutdown, temperature increasing		+170		$^{\circ}\text{C}$
	Reset, temperature decreasing		+150		$^{\circ}\text{C}$
T_J Operating junction temperature range		-40		+125	$^{\circ}\text{C}$

(1) At operating conditions, $V_{IN} \leq 0\text{ V}$, $V_{OUT(NOM)} \leq V_{REF} \leq 0\text{ V}$. At regulation, $V_{IN} \leq V_{OUT(NOM)} - |V_{DO}|$. $I_{OUT} > 0$ flows from OUT to IN.

(2) To ensure stability at no load conditions, a current from the feedback resistive network equal to or greater than $5\text{ }\mu\text{A}$ is required.

(3) $I_{FB} > 0$ flows into the device.

(4) C_{FF} refers to a feed-forward capacitor connected to the FB and OUT pins.

PARAMETRIC MEASUREMENT INFORMATION

TYPICAL APPLICATION CIRCUIT

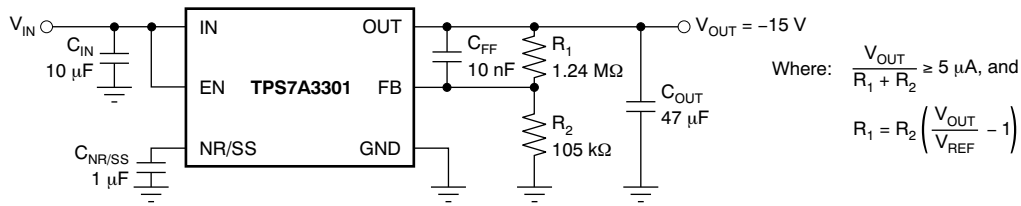

Maximize PSRR Performance and Minimize RMS Noise

PIN CONFIGURATIONS

KC PACKAGE
TO-220-7
(TOP VIEW)

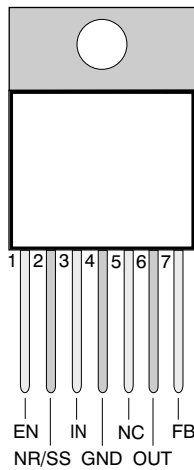

RGW PACKAGE
5-mm x 5-mm QFN-20
(TOP VIEW)

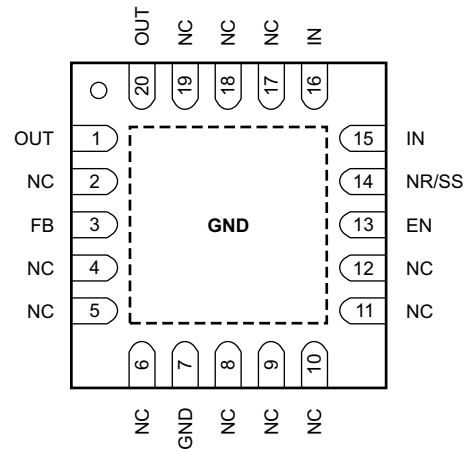

PIN DESCRIPTIONS

NAME	NO.		DESCRIPTION
	KC	RGW ⁽¹⁾	
EN	1	13	This pin turns the regulator on or off. If $V_{EN} \geq V_{+EN_HI}$ or $V_{EN} \leq V_{-EN_HI}$, the regulator is enabled. If $V_{+EN_LO} \geq V_{EN} \geq V_{-EN_LO}$, the regulator is disabled. The EN pin can be connected to IN, if not used. $ V_{EN} \leq V_{IN} $.
FB	7	3	This pin is the input to the control-loop error amplifier. It is used to set the output voltage of the device. It is recommended to connect a 0.01-µF capacitor from FB to OUT (as close to the device as possible) to maximize ac performance.
GND	4	7	Ground
IN	3	15, 16	Input supply. A capacitor greater than or equal to 10 nF must be tied from this pin to ground to assure stability. It is recommended to connect a 10-µF capacitor from IN to GND (as close to the device as possible) to reduce circuit sensitivity to printed-circuit-board (PCB) layout, especially when long input traces or high source impedances are encountered.
NC	5	2, 4-6, 8-12, 17-19	This pin can be left open or tied to any voltage between GND and IN.
NR/SS	2	14	Noise reduction pin. A capacitor connected from this pin to GND controls the soft-start function and allows RMS noise to be reduced to very low levels. It is recommended to connect a 1-µF capacitor from NR/SS to GND (as close to the device as possible) to bypass the noise generated by the internal bandgap and maximize ac performance.
OUT	6	1, 20	Regulator output. A capacitor greater than or equal to 10 µF must be tied from this pin to ground to assure stability. It is recommended to connect a 47-µF ceramic capacitor from OUT to GND (as close to the device as possible) to maximize ac performance.
Tab	Tab	—	TAB is internally connected to GND. An external heatsink can be installed to provide additional thermal performance.

(1) RGW is a product-preview device.

FUNCTIONAL BLOCK DIAGRAM

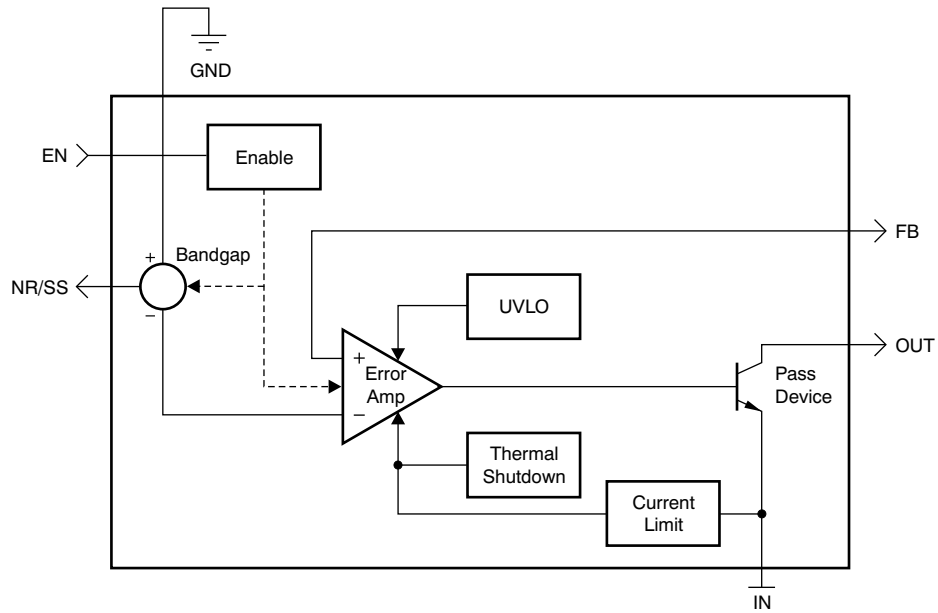

TYPICAL CHARACTERISTICS

At $T_J = -40^\circ\text{C}$ to $+125^\circ\text{C}$, $|V_{IN}| = |V_{OUT(NOM)}| + 1.0\text{ V}$ or $|V_{IN}| = 3.0\text{ V}$ (whichever is greater), $V_{EN} = V_{IN}$, $I_{OUT} = 1\text{ mA}$, $C_{IN} = 22\ \mu\text{F}$, $C_{OUT} = 22\ \mu\text{F}$, $C_{NR/SS} = 0\text{ nF}$, and the FB pin tied to OUT, unless otherwise noted.

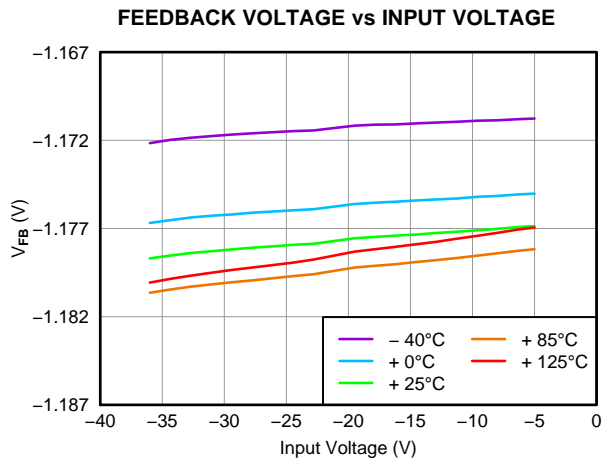

Figure 1.

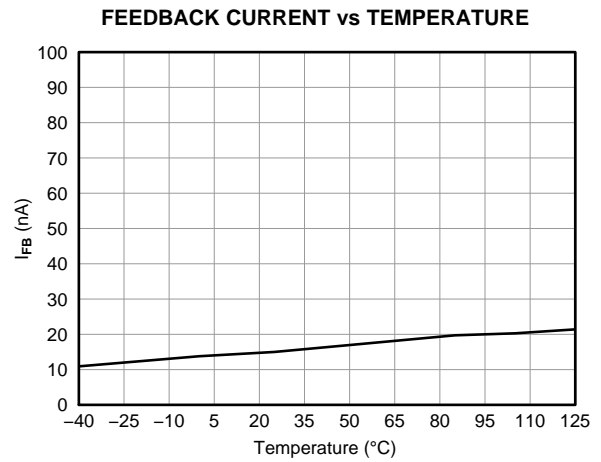

Figure 2.

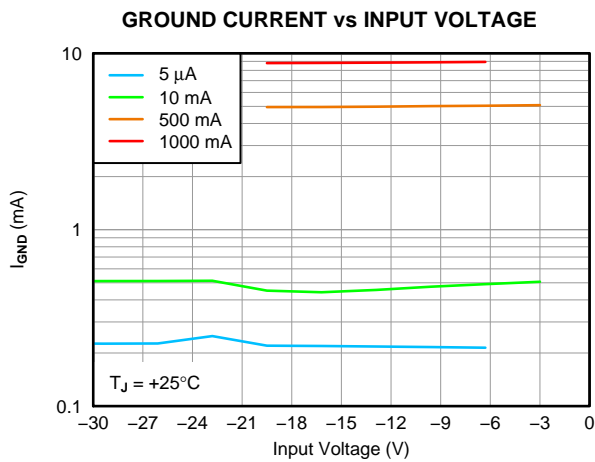

Figure 3.

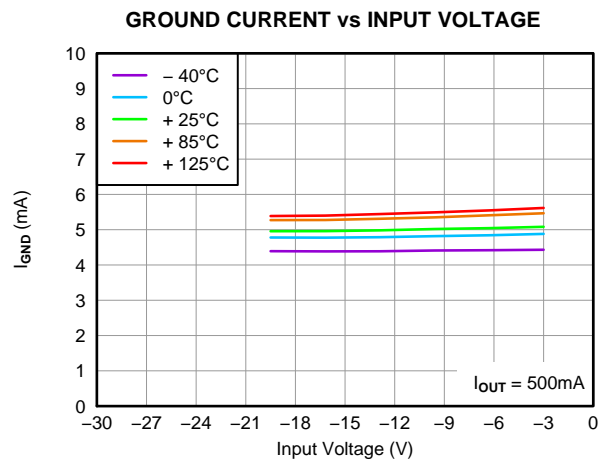

Figure 4.

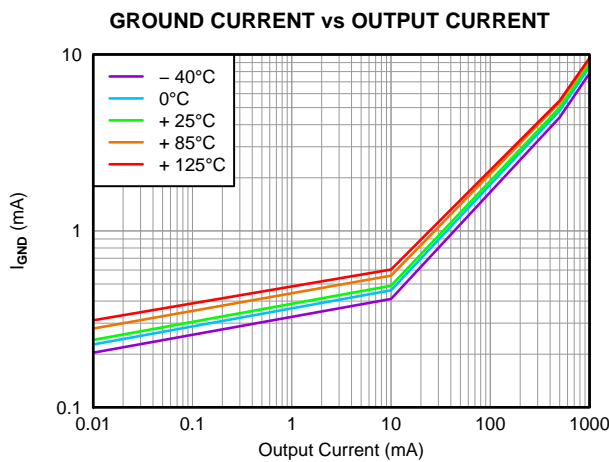

Figure 5.

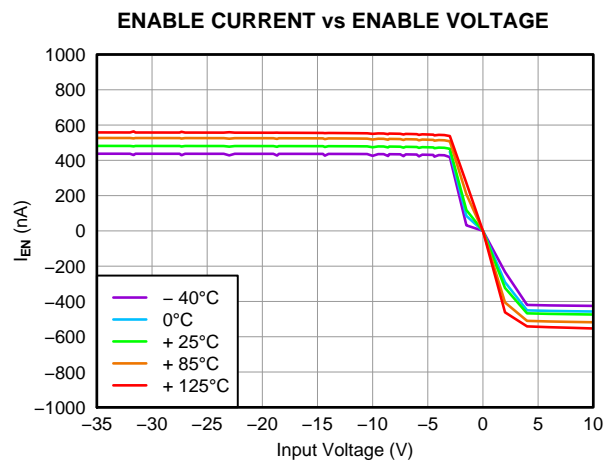

Figure 6.

TYPICAL CHARACTERISTICS (continued)

At $T_J = -40^\circ\text{C}$ to $+125^\circ\text{C}$, $|V_{IN}| = |V_{OUT(NOM)}| + 1.0\text{ V}$ or $|V_{IN}| = 3.0\text{ V}$ (whichever is greater), $V_{EN} = V_{IN}$, $I_{OUT} = 1\text{ mA}$, $C_{IN} = 22\ \mu\text{F}$, $C_{OUT} = 22\ \mu\text{F}$, $C_{NR/SS} = 0\text{ nF}$, and the FB pin tied to OUT, unless otherwise noted.

QUIESCENT CURRENT vs INPUT VOLTAGE

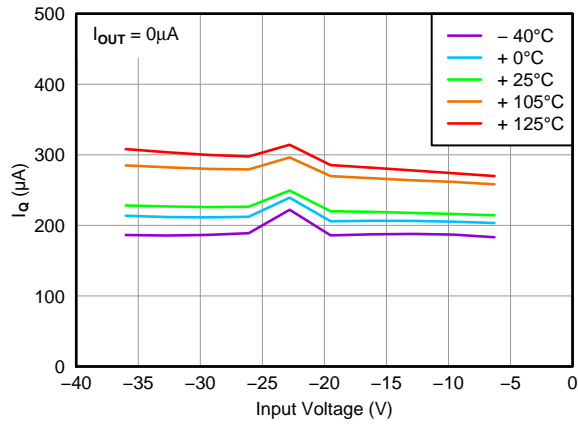

Figure 7.

SHUTDOWN CURRENT vs INPUT VOLTAGE

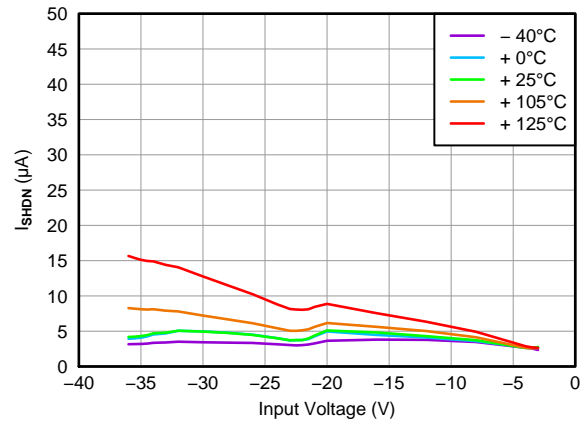

Figure 8.

DROPOUT VOLTAGE vs OUTPUT CURRENT

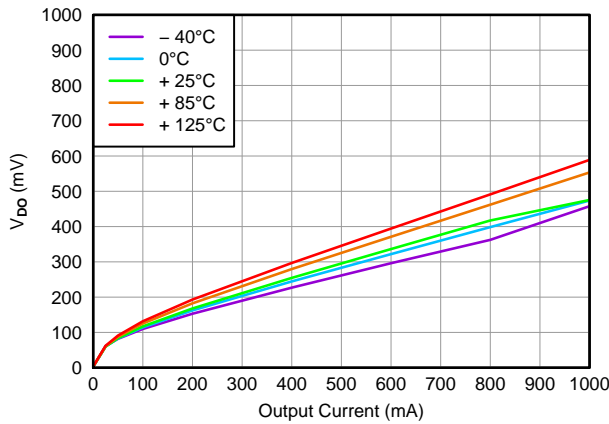

Figure 9.

DROPOUT VOLTAGE vs TEMPERATURE

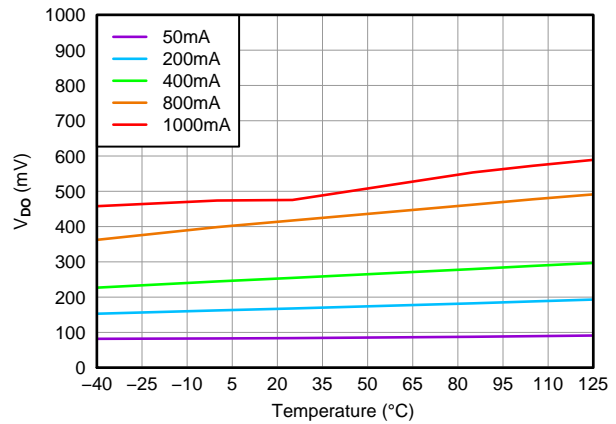

Figure 10.

ENABLE THRESHOLD VOLTAGE vs TEMPERATURE

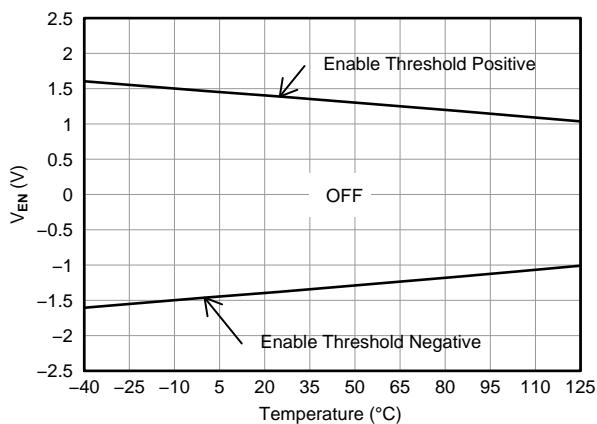

Figure 11.

LINE REGULATION

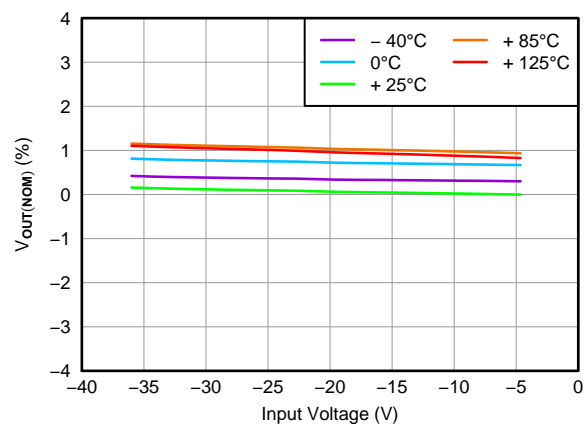

Figure 12.

TYPICAL CHARACTERISTICS (continued)

At $T_J = -40^\circ\text{C}$ to $+125^\circ\text{C}$, $|V_{IN}| = |V_{OUT(NOM)}| + 1.0\text{ V}$ or $|V_{IN}| = 3.0\text{ V}$ (whichever is greater), $V_{EN} = V_{IN}$, $I_{OUT} = 1\text{ mA}$, $C_{IN} = 22\ \mu\text{F}$, $C_{OUT} = 22\ \mu\text{F}$, $C_{NR/SS} = 0\text{ nF}$, and the FB pin tied to OUT, unless otherwise noted.

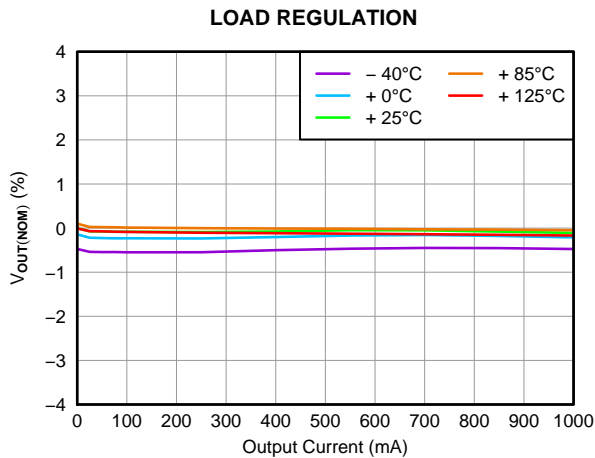

Figure 13.

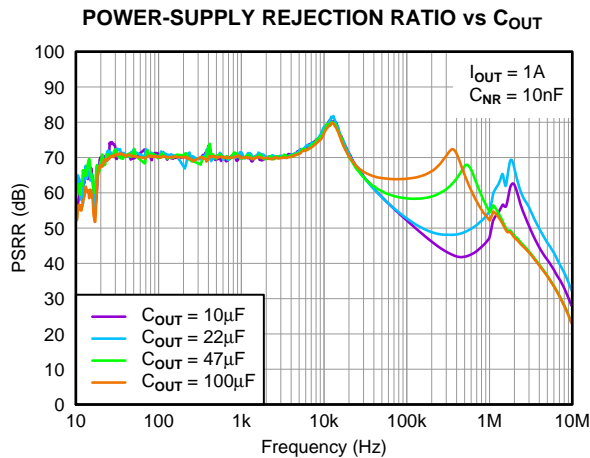

Figure 14.

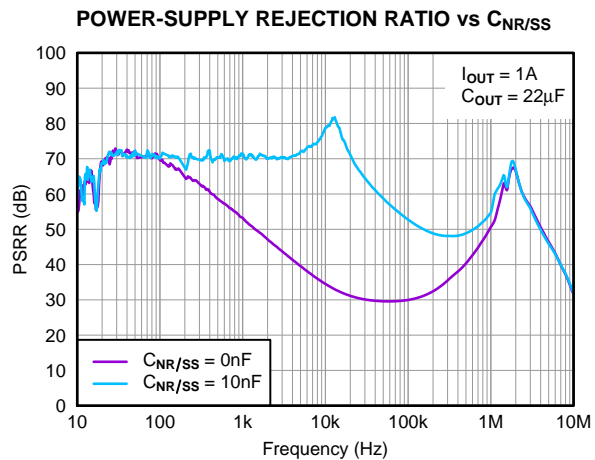

Figure 15.

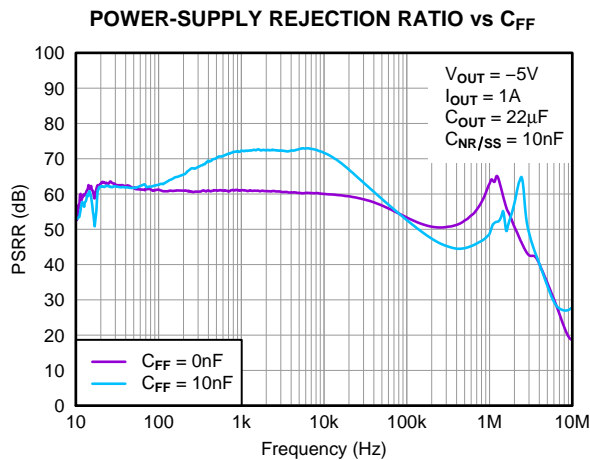

Figure 16.

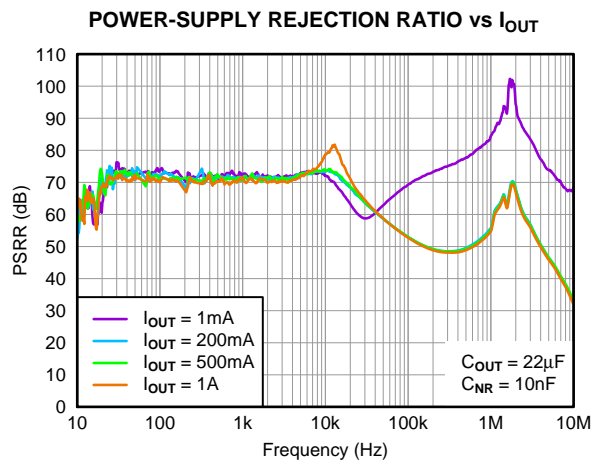

Figure 17.

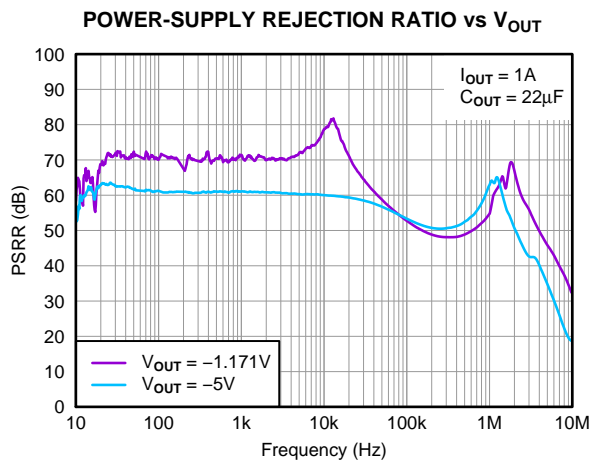

Figure 18.

TYPICAL CHARACTERISTICS (continued)

At $T_J = -40^\circ\text{C}$ to $+125^\circ\text{C}$, $|V_{IN}| = |V_{OUT(NOM)}| + 1.0\text{ V}$ or $|V_{IN}| = 3.0\text{ V}$ (whichever is greater), $V_{EN} = V_{IN}$, $I_{OUT} = 1\text{ mA}$, $C_{IN} = 22\text{ }\mu\text{F}$, $C_{OUT} = 22\text{ }\mu\text{F}$, $C_{NR/SS} = 0\text{ nF}$, and the FB pin tied to OUT, unless otherwise noted.

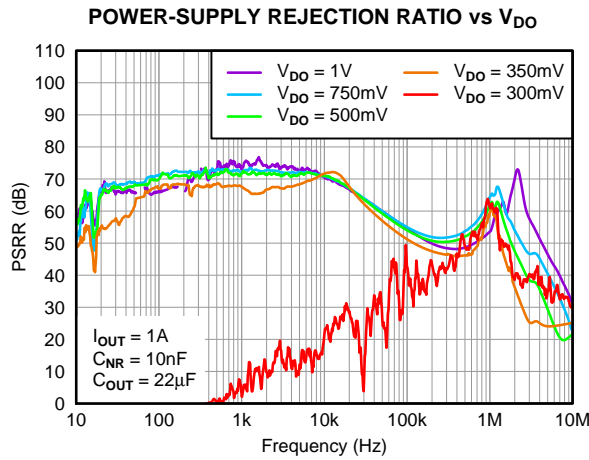

Figure 19.

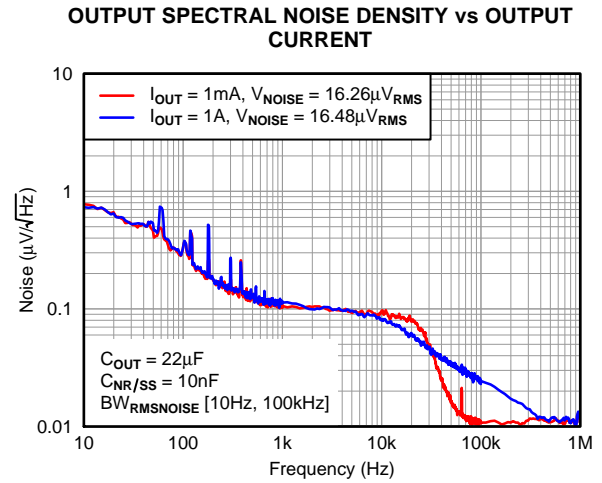

Figure 20.

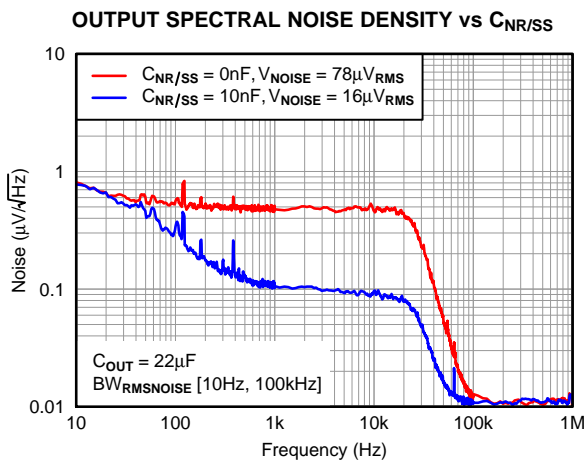

Figure 21.

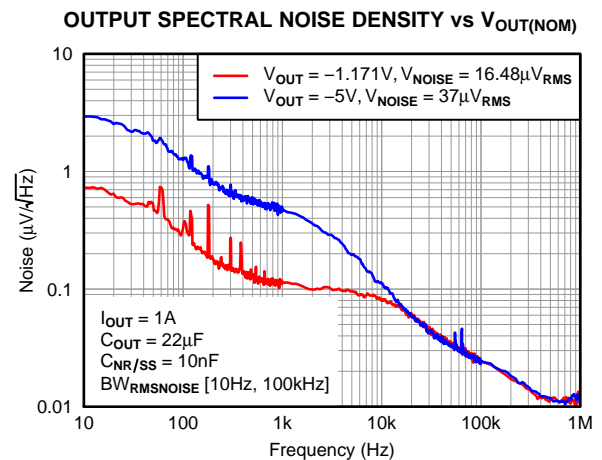

Figure 22.

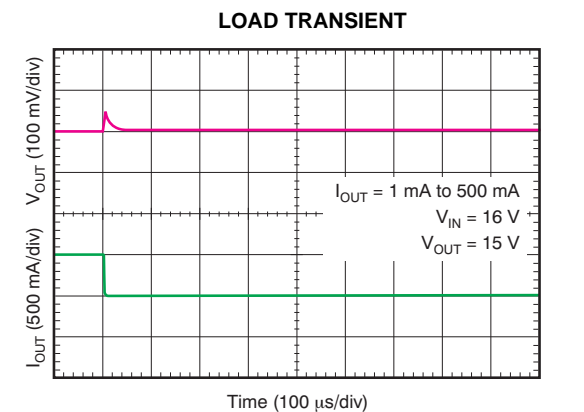

Figure 23.

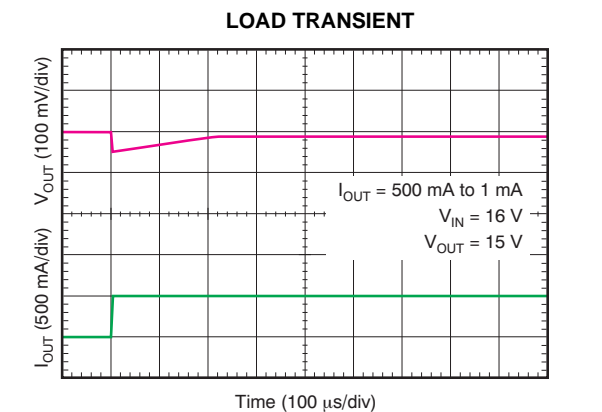
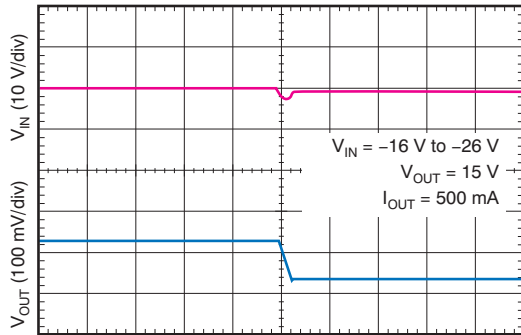

Figure 24.

TYPICAL CHARACTERISTICS (continued)

At $T_J = -40^\circ\text{C}$ to $+125^\circ\text{C}$, $|V_{IN}| = |V_{OUT(NOM)}| + 1.0\text{ V}$ or $|V_{IN}| = 3.0\text{ V}$ (whichever is greater), $V_{EN} = V_{IN}$, $I_{OUT} = 1\text{ mA}$, $C_{IN} = 22\text{ }\mu\text{F}$, $C_{OUT} = 22\text{ }\mu\text{F}$, $C_{NR/SS} = 0\text{ nF}$, and the FB pin tied to OUT, unless otherwise noted.

LINE TRANSIENT



Time (500 $\mu\text{s/div}$)

Figure 25.

LINE TRANSIENT

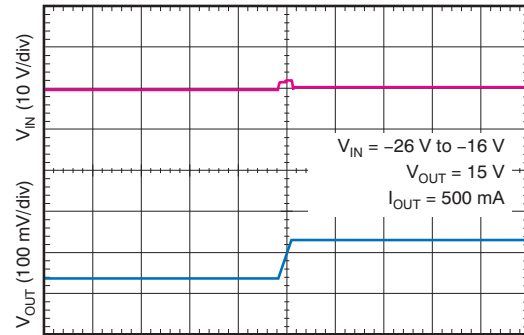

Time (500 $\mu\text{s/div}$)

Figure 26.

CAPACITOR-PROGRAMMABLE SOFT-START

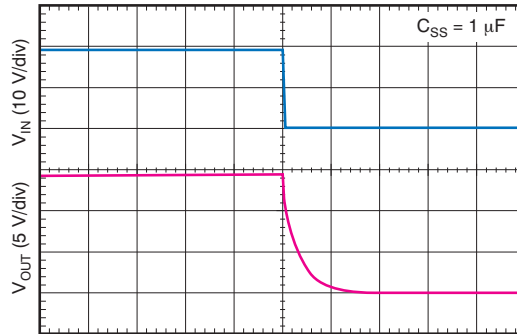

Time (20 ms/div)

Figure 27.

THEORY OF OPERATION

GENERAL DESCRIPTION

The TPS7A33 belongs to a family of new-generation linear regulators that use an innovative bipolar process to achieve ultralow-noise and very high PSRR levels at a wide input voltage and current range. These features, combined with the external heatsink-capable, high thermal performance TO-220 package, make this device ideal for high-performance analog applications.

ADJUSTABLE OPERATION

The TPS7A3301 has an output voltage range of -1.182 V to -33 V . The nominal output voltage of the device is set by two external resistors, as shown in [Figure 28](#).

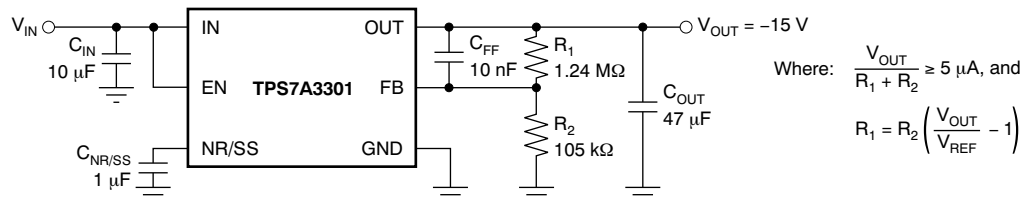

Figure 28. Adjustable Operation for Maximum AC Performance

R_1 and R_2 can be calculated for any output voltage range using [Equation 1](#). To ensure stability under no load conditions at $V_{OUT} > V_{REF}$, this resistive network must provide a current equal to or greater than $5\ \mu\text{A}$.

$$R_1 = R_2 \left(\frac{V_{OUT}}{V_{REF}} - 1 \right), \quad \text{where } \frac{V_{OUT}}{R_1 + R_2} \geq 5\ \mu\text{A} \quad (1)$$

If greater voltage accuracy is required, take into account the output voltage offset contributions because of the feedback pin current and use 0.1% tolerance resistors.

[Table 1](#) shows the resistor combination to achieve a few of the most common rails using commercially-available, 0.1%-tolerance resistors to maximize nominal voltage accuracy while abiding to the formula shown in [Equation 1](#):

Table 1. Suggested Resistors for Common Voltage Rails

V_{OUT}	R_1	R_2	$V_{OUT}/(R_1+R_2)$	NOMINAL ACCURACY
-1.171 V	$0\ \Omega$	∞	$0\ \mu\text{A}$	$\pm 1.5\%$
-1.8 V	$76.8\text{ k}\Omega$	$143\text{ k}\Omega$	$8.18\ \mu\text{A}$	$\pm(1.5\% + 0.08\%)$
-3.3 V	$200\text{ k}\Omega$	$110\text{ k}\Omega$	$10.64\ \mu\text{A}$	$\pm(1.5\% + 0.13\%)$
-5 V	$332\text{ k}\Omega$	$102\text{ k}\Omega$	$11.48\ \mu\text{A}$	$\pm(1.5\% + 0.50\%)$
-10 V	$1.62\text{ M}\Omega$	$215\text{ k}\Omega$	$5.44\ \mu\text{A}$	$\pm(1.5\% + 0.23\%)$
-12 V	$1.5\text{ M}\Omega$	$162\text{ k}\Omega$	$7.22\ \mu\text{A}$	$\pm(1.5\% + 0.29\%)$
-15 V	$1.24\text{ M}\Omega$	$105\text{ k}\Omega$	$11.15\ \mu\text{A}$	$\pm(1.5\% + 0.18\%)$
-18 V	$3.09\text{ M}\Omega$	$215\text{ k}\Omega$	$5.44\ \mu\text{A}$	$\pm(1.5\% + 0.19\%)$
-24 V	$1.15\text{ M}\Omega$	$59\text{ k}\Omega$	$19.84\ \mu\text{A}$	$\pm(1.5\% + 0.21\%)$

ENABLE PIN OPERATION

The TPS7A33 provides a dual-polarity enable pin (EN) that turns on the regulator when $|V_{EN}| > 2.0$ V, whether the voltage is positive or negative, as shown in [Figure 29](#).

This functionality allows for different system power management topologies; for example:

- Connecting the EN pin directly to a negative voltage, such as V_{IN} , or
- Connecting the EN pin directly to a positive voltage, such as the output of digital logic circuitry.

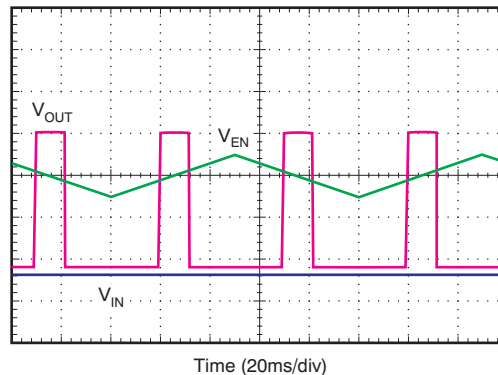

Figure 29. Enable Pin Positive/Negative Threshold

CAPACITOR RECOMMENDATIONS

Low equivalent series resistance (ESR) capacitors should be used for the input, output, noise reduction, and bypass capacitors. Ceramic capacitors with X7R and X5R dielectrics are preferred. These dielectrics offer more stable characteristics. Ceramic X7R capacitors offer improved over-temperature performance, while ceramic X5R capacitors are the most cost-effective and are available in higher values.

Note that high-ESR capacitors may degrade PSRR.

INPUT AND OUTPUT CAPACITOR REQUIREMENTS

The TPS7A33 family of negative, high-voltage linear regulators achieve stability with a minimum input and output capacitance of 10 μF ; however, it is highly recommended to use a 47- μF capacitor to maximize ac performance.

NOISE REDUCTION AND FEED-FORWARD CAPACITOR REQUIREMENTS

Although the noise-reduction ($C_{NR/SS}$) and feed-forward (C_{FF}) capacitors are not needed to achieve stability, it is highly recommended to use a 0.01- μF feed-forward capacitor and a 1- μF noise-reduction capacitor to minimize noise and maximize ac performance.

MAXIMUM AC PERFORMANCE

In order to maximize noise and PSRR performance, it is recommended to include 47- μF or higher input and output capacitors, 1- μF noise-reduction capacitors, and 0.01- μF feed-forward capacitors, as shown in [Figure 28](#). The solution shown delivers minimum noise levels of 16 μV_{RMS} and power-supply rejection levels above 55 dB from 10 Hz to 1 MHz; see [Figure 19](#).

OUTPUT NOISE

The TPS7A33 provides low output noise when a noise-reduction capacitor ($C_{NR/SS}$) is used.

The noise-reduction capacitor serves as a filter for the internal reference. By using a 1- μ F noise reduction capacitor, the output noise is reduced by almost 80% (from 80 μ V_{RMS} to 17 μ V_{RMS}); see [Figure 21](#).

The TPS7A33 low output voltage noise makes it an ideal solution for powering noise-sensitive circuitry.

POWER-SUPPLY REJECTION

The 1- μ F noise-reduction capacitor greatly improves TPS7A33 power-supply rejection, achieving up to 10 dB of additional power-supply rejection for frequencies between 140 Hz and 500 KHz.

Additionally, ac performance can be maximized by adding a 0.01- μ F feed-forward capacitor (C_{FF}) from the FB pin to the OUT pin. This capacitor greatly improves power-supply rejection at lower frequencies, for the band from 100 Hz to 100 kHz; see [Figure 15](#).

The very-high power-supply rejection of the TPS7A33 makes it a good choice for powering high-performance analog circuitry, such as operational amplifiers, ADCs, DACS, and audio amplifiers.

TRANSIENT RESPONSE

As with any regulator, increasing the size of the output capacitor reduces over/undershoot magnitude, but increases duration of the transient response.

APPLICATION INFORMATION

POWER FOR PRECISION ANALOG

One of the primary TPS7A33 applications is to provide ultralow-noise voltage rails to high-performance analog circuitry in order to maximize system accuracy and precision.

The TPS7A33 family of negative, high-voltage linear regulators provides ultralow noise, positive and negative voltage rails to high-performance analog circuitry such as operational amplifiers, ADCs, DACs, and audio amplifiers.

Because of the ultralow noise levels at high voltages, analog circuitry with high-voltage input supplies can be used. This characteristic allows for high-performance analog solutions to optimize the voltage range, thus maximizing system accuracy.

POST DC-DC CONVERTER FILTERING

Most of the time, the voltage rails available in a system do not match the voltage specifications demanded by one or more of its circuits; these rails must be stepped up or down, depending on specific voltage requirements.

DC-DC converters are the preferred solution to stepping up or down a voltage rail when current consumption is not negligible. They offer high efficiency with minimum heat generation, but they have one primary disadvantage: they introduce a high-frequency component, and the associated harmonics, on top of the dc output signal.

If not filtered properly, this high-frequency component degrades analog circuitry performance, reducing overall system accuracy and precision.

The TPS7A33 offers a wide-bandwidth, very-high power-supply rejection ratio. This specification makes it ideal for post dc-dc converter filtering, as shown in [Figure 30](#). It is highly recommended to use the maximum performance schematic shown in [Figure 28](#). Also, verify that the fundamental frequency (and its first harmonic, if possible) is within the bandwidth of the regulator PSRR, shown in [Figure 16](#).

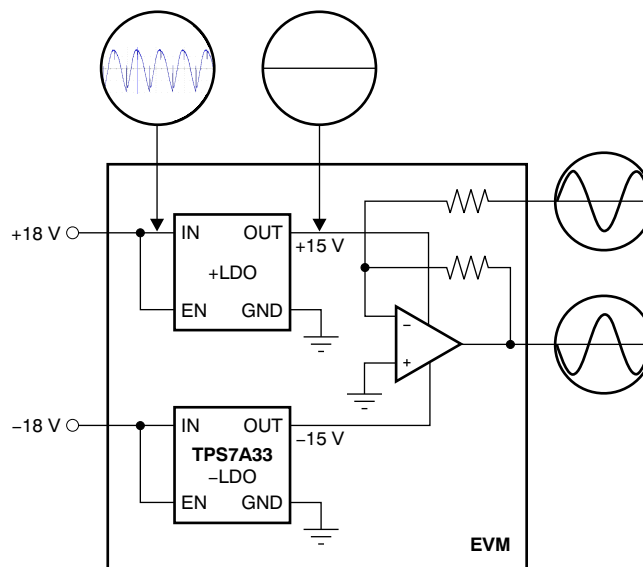

Figure 30. Post DC-DC Converter Regulation to High-Performance Analog Circuitry

AUDIO APPLICATIONS

Audio applications are extremely sensitive to any distortion and noise in the audio band from 20 Hz to 20 kHz. This stringent requirement demands clean voltage rails to power critical high-performance audio systems.

The very-high power-supply rejection ratio (> 60 dB) and low noise at the audio band of the TPS7A33 maximize performance for audio applications; see [Figure 16](#).

LAYOUT

POWER DISSIPATION

The primary TPS7A33 application is to provide ultralow noise voltage rails to high-performance analog circuitry in order to maximize system accuracy and precision. The high-current and high-voltage characteristics of this regulator means that, often enough, high power (heat) is dissipated from the device itself. This heat, if dissipated into the PCB (as is the case with SMT packages), creates a temperature gradient in the surrounding area that causes nearby components to react to this temperature change (drift). In high-performance systems, such drift may degrade overall system accuracy and precision.

Compared to surface-mount packages, the TO-220 (KC) package allows for an external heatsink to be used to maximize thermal performance and keep heat from dissipating into the PCB.

Power dissipation depends on input voltage and load conditions. Power dissipation (P_D) is equal to the product of the output current times the voltage drop across the output pass element, as shown in [Equation 2](#):

$$P_D = (V_{IN} - V_{OUT}) I_{OUT} \quad (2)$$

THERMAL PERFORMANCE AND HEATSINK SELECTION

Heat flows from the device to the ambient air through many paths, each of which represents resistance to the heat flow; this is called thermal resistance.

The total thermal resistance of a system is defined by: $\theta_{JA} = (T_J - T_A)/P_D$; where: θ_{JA} is the thermal resistance (in °C/W), T_J is the allowable junction temperature of the device (in °C), T_A is the maximum temperature of the ambient cooling air (in °C), and P_D is the amount of power (heat) dissipated by the device (in W).

Whenever a heatsink is installed, the total thermal resistance (θ_{JA}) is the sum of all the individual resistances from the device, going through its case and heatsink to the ambient cooling air ($\theta_{JA} = \theta_{JC} + \theta_{CS} + \theta_{SA}$). Realistically, only two resistances can be controlled: θ_{CS} and θ_{SA} . Therefore, for a device with a known θ_{JC} , θ_{CS} and θ_{SA} become the main design variables in selecting a heat sink.

The thermal interface between the case and the heat sink (θ_{CS}) is controlled by selecting the correct heat-conducting material. Once the θ_{CS} is selected, the required thermal resistance from the heatsink to ambient is calculated by the following equation: $\theta_{SA} = [(T_J - T_A)/P_D] - [\theta_{JC} + \theta_{CS}]$. This information allows the the most appropriate heatsink to be selected for any particular application.

PACKAGE MOUNTING

The TO-220 (KC) 7-lead, straight-formed package lead spacing poses a challenge when creating a suitable PCB footprint without bending the leads. Component forming pliers, such as Excelta's Q-6482, can be used to manually bend the package leads into a 7-lead stagger pattern with increased lead spacing that can be more easily used.

The TPS7A33 evaluation board layout can be used as a guideline on suitable PCB footprints, available at www.ti.com

BOARD LAYOUT RECOMMENDATIONS TO IMPROVE PSRR AND NOISE PERFORMANCE

To improve ac performance such as PSRR, output noise, and transient response, it is recommended that the board be designed with separate planes for IN, OUT, and GND. The IN and OUT planes should be isolated from each other by a GND plane section. In addition, the ground connection for the output capacitor should connect directly to the GND pin of the device.

Equivalent series inductance (ESL) and equivalent series resistance (ESR) must be minimized in order to maximize performance and ensure stability. Every capacitor (C_{IN} , C_{OUT} , $C_{NR/SS}$, C_{FF}) must be placed as close as possible to the device and on the same side of the printed circuit board (PCB) as the regulator itself.

Do not place any of the capacitors on the opposite side of the PCB from where the regulator is installed. The use of vias and long traces is strongly discouraged because they may impact system performance negatively and even cause instability.

If possible, and to ensure the maximum performance specified in this product datasheet, use the same layout pattern used for the TPS7A33 evaluation board, available at www.ti.com.

THERMAL PROTECTION

Thermal protection disables the output when the junction temperature rises to approximately +170°C, allowing the device to cool. When the junction temperature cools to approximately +150°C, the output circuitry is enabled. Depending on power dissipation, thermal resistance, and ambient temperature, the thermal protection circuit may cycle on and off. This cycling limits the dissipation of the regulator, protecting it from damage as a result of overheating.

Any tendency to activate the thermal protection circuit indicates excessive power dissipation or an inadequate heatsink. For reliable operation, junction temperature should be limited to a maximum of +125°C. To estimate the margin of safety in a complete design (including heatsink), increase the ambient temperature until the thermal protection is triggered; use worst-case loads and signal conditions. For good reliability, thermal protection should trigger at least +35°C above the maximum expected ambient condition of your particular application. This configuration produces a worst-case junction temperature of +125°C at the highest expected ambient temperature and worst-case load.

The internal protection circuitry of the TPS7A33 has been designed to protect against overload conditions. It was not intended to replace proper heatsinking. Continuously running the TPS7A33 into thermal shutdown degrades device reliability.

SUGGESTED LAYOUT AND SCHEMATIC

Layout is a critical part of good power-supply design. There are several signal paths that conduct fast-changing currents or voltages that can interact with stray inductance or parasitic capacitance to generate noise or degrade the power-supply performance. To help eliminate these problems, the IN pin should be bypassed to ground with a low ESR ceramic bypass capacitor with a X5R or X7R dielectric.

It may be possible to obtain acceptable performance with alternative PCB layouts; however, the layout shown in [Figure 31](#) and the schematic shown in [Figure 32](#) have been shown to produce good results and are meant as a guideline.

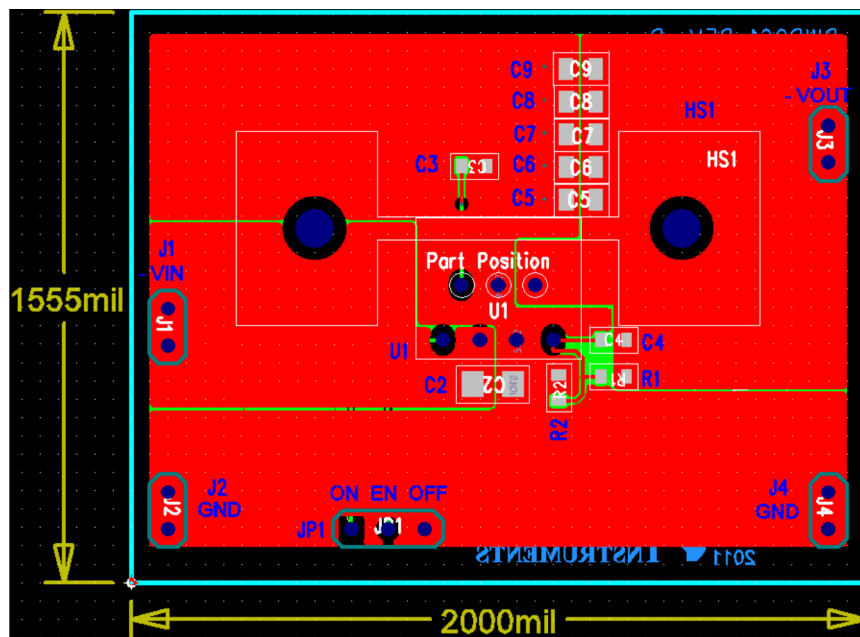

Figure 31. PCB Layout Example: Top Layer

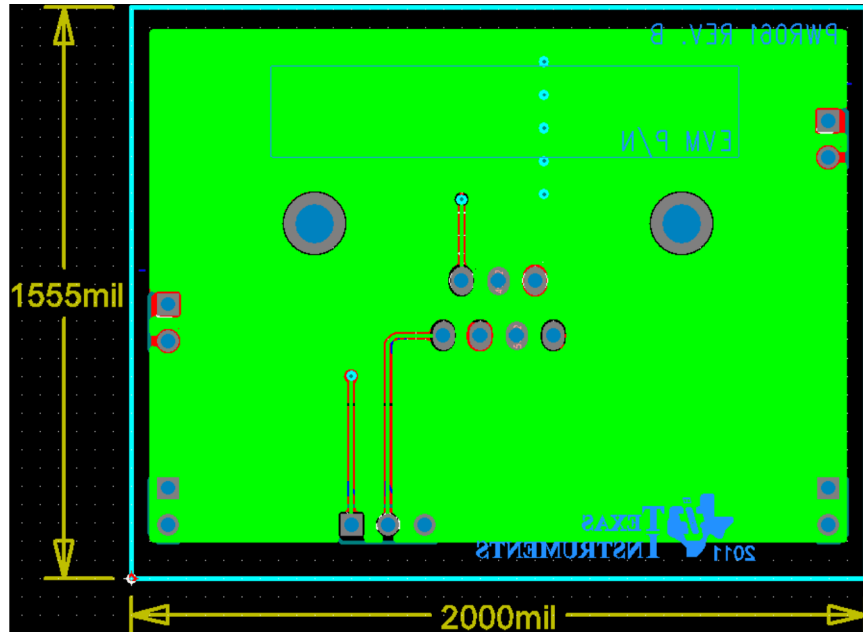

Figure 32. PCB Layout Example: Bottom Layer

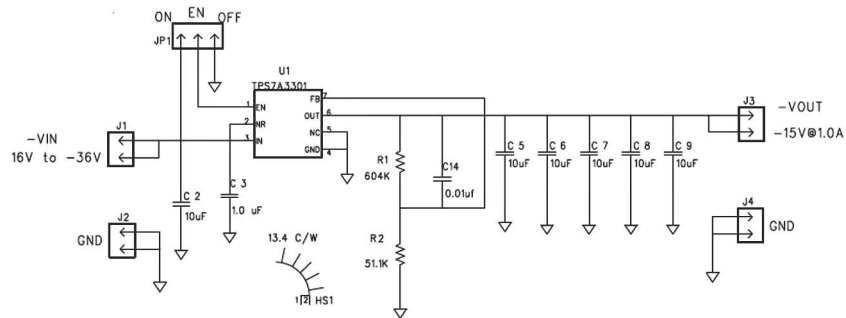

Figure 33. Schematic for PCB Layout Example

REVISION HISTORY

NOTE: Page numbers for previous revisions may differ from page numbers in the current version.

Changes from Revision A (December 2011) to Revision B **Page**

- Changed product status from Production Data to Mixed Status 1
 - Added RGW pin out drawing 1
 - Added RGW column to Thermal Information table 2
 - Added RGW pin out drawing to Pin Configurations section 4
 - Added RGW and footnote 1 to Pin Descriptions table 4
-

Changes from Original (December 2011) to Revision A **Page**

- Changed product status from Product Preview to Production Data 1
-

PACKAGING INFORMATION

Orderable Device	Status ⁽¹⁾	Package Type	Package Drawing	Pins	Package Qty	Eco Plan ⁽²⁾	Lead/ Ball Finish	MSL Peak Temp ⁽³⁾	Samples (Requires Login)
TPS7A3301KC	ACTIVE	TO-220	KC	7	50	TBD	CU	Level-2-260C-1 YEAR	
TPS7A3301RGWR	ACTIVE	VQFN	RGW	20	3000	Green (RoHS & no Sb/Br)	CU NIPDAU	Level-2-260C-1 YEAR	
TPS7A3301RGWT	ACTIVE	VQFN	RGW	20	250	Green (RoHS & no Sb/Br)	CU NIPDAU	Level-2-260C-1 YEAR	

⁽¹⁾ The marketing status values are defined as follows:

ACTIVE: Product device recommended for new designs.

LIFEBUY: TI has announced that the device will be discontinued, and a lifetime-buy period is in effect.

NRND: Not recommended for new designs. Device is in production to support existing customers, but TI does not recommend using this part in a new design.

PREVIEW: Device has been announced but is not in production. Samples may or may not be available.

OBSOLETE: TI has discontinued the production of the device.

⁽²⁾ Eco Plan - The planned eco-friendly classification: Pb-Free (RoHS), Pb-Free (RoHS Exempt), or Green (RoHS & no Sb/Br) - please check <http://www.ti.com/productcontent> for the latest availability information and additional product content details.

TBD: The Pb-Free/Green conversion plan has not been defined.

Pb-Free (RoHS): TI's terms "Lead-Free" or "Pb-Free" mean semiconductor products that are compatible with the current RoHS requirements for all 6 substances, including the requirement that lead not exceed 0.1% by weight in homogeneous materials. Where designed to be soldered at high temperatures, TI Pb-Free products are suitable for use in specified lead-free processes.

Pb-Free (RoHS Exempt): This component has a RoHS exemption for either 1) lead-based flip-chip solder bumps used between the die and package, or 2) lead-based die adhesive used between the die and leadframe. The component is otherwise considered Pb-Free (RoHS compatible) as defined above.

Green (RoHS & no Sb/Br): TI defines "Green" to mean Pb-Free (RoHS compatible), and free of Bromine (Br) and Antimony (Sb) based flame retardants (Br or Sb do not exceed 0.1% by weight in homogeneous material)

⁽³⁾ MSL, Peak Temp. -- The Moisture Sensitivity Level rating according to the JEDEC industry standard classifications, and peak solder temperature.

Important Information and Disclaimer: The information provided on this page represents TI's knowledge and belief as of the date that it is provided. TI bases its knowledge and belief on information provided by third parties, and makes no representation or warranty as to the accuracy of such information. Efforts are underway to better integrate information from third parties. TI has taken and continues to take reasonable steps to provide representative and accurate information but may not have conducted destructive testing or chemical analysis on incoming materials and chemicals. TI and TI suppliers consider certain information to be proprietary, and thus CAS numbers and other limited information may not be available for release.

In no event shall TI's liability arising out of such information exceed the total purchase price of the TI part(s) at issue in this document sold by TI to Customer on an annual basis.

TAPE AND REEL INFORMATION
REEL DIMENSIONS

TAPE DIMENSIONS

A0	Dimension designed to accommodate the component width
B0	Dimension designed to accommodate the component length
K0	Dimension designed to accommodate the component thickness
W	Overall width of the carrier tape
P1	Pitch between successive cavity centers

TAPE AND REEL INFORMATION

*All dimensions are nominal

Device	Package Type	Package Drawing	Pins	SPQ	Reel Diameter (mm)	Reel Width W1 (mm)	A0 (mm)	B0 (mm)	K0 (mm)	P1 (mm)	W (mm)	Pin1 Quadrant
TPS7A3301RGWR	VQFN	RGW	20	3000	330.0	12.4	5.3	5.3	1.5	8.0	12.0	Q2
TPS7A3301RGWT	VQFN	RGW	20	250	180.0	12.4	5.3	5.3	1.5	8.0	12.0	Q2

TAPE AND REEL BOX DIMENSIONS



*All dimensions are nominal

Device	Package Type	Package Drawing	Pins	SPQ	Length (mm)	Width (mm)	Height (mm)
TPS7A3301RGWR	VQFN	RGW	20	3000	367.0	367.0	35.0
TPS7A3301RGWT	VQFN	RGW	20	250	210.0	185.0	35.0

MECHANICAL DATA

RGW (S-PVQFN-N20)

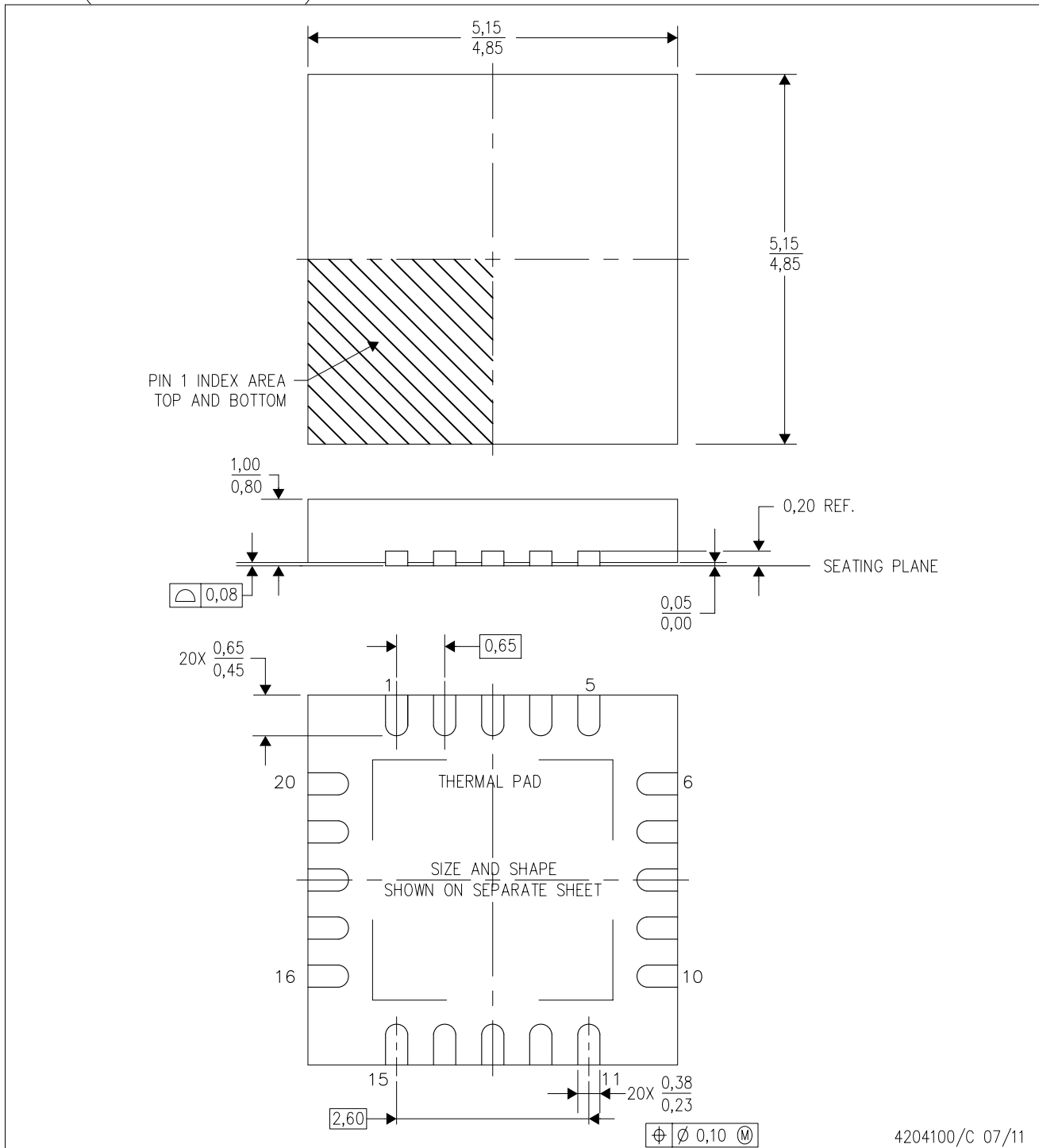
PLASTIC QUAD FLATPACK NO-LEAD



- NOTES:
- All linear dimensions are in millimeters. Dimensioning and tolerancing per ASME Y14.5-1994.
 - This drawing is subject to change without notice.
 - Quad Flat pack, No-leads (QFN) package configuration
 - The package thermal pad must be soldered to the board for thermal and mechanical performance.
 - See the additional figure in the Product Data Sheet for details regarding the exposed thermal pad features and dimensions.
 - Falls within JEDEC MO-220.

THERMAL PAD MECHANICAL DATA

RGW (S-PVQFN-N20)

PLASTIC QUAD FLATPACK NO-LEAD

THERMAL INFORMATION

This package incorporates an exposed thermal pad that is designed to be attached directly to an external heatsink. The thermal pad must be soldered directly to the printed circuit board (PCB). After soldering, the PCB can be used as a heatsink. In addition, through the use of thermal vias, the thermal pad can be attached directly to the appropriate copper plane shown in the electrical schematic for the device, or alternatively, can be attached to a special heatsink structure designed into the PCB. This design optimizes the heat transfer from the integrated circuit (IC).

For information on the Quad Flatpack No-Lead (QFN) package and its advantages, refer to Application Report, QFN/SON PCB Attachment, Texas Instruments Literature No. SLUA271. This document is available at www.ti.com.

The exposed thermal pad dimensions for this package are shown in the following illustration.

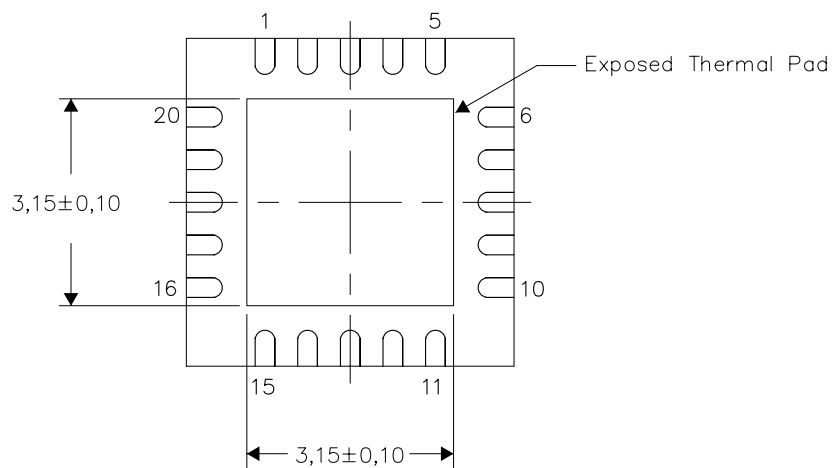

Bottom View

Exposed Thermal Pad Dimensions

4206352-2/J 07/11

NOTE: All linear dimensions are in millimeters

RGW (S-PVQFN-N20)

PLASTIC QUAD FLATPACK NO-LEAD

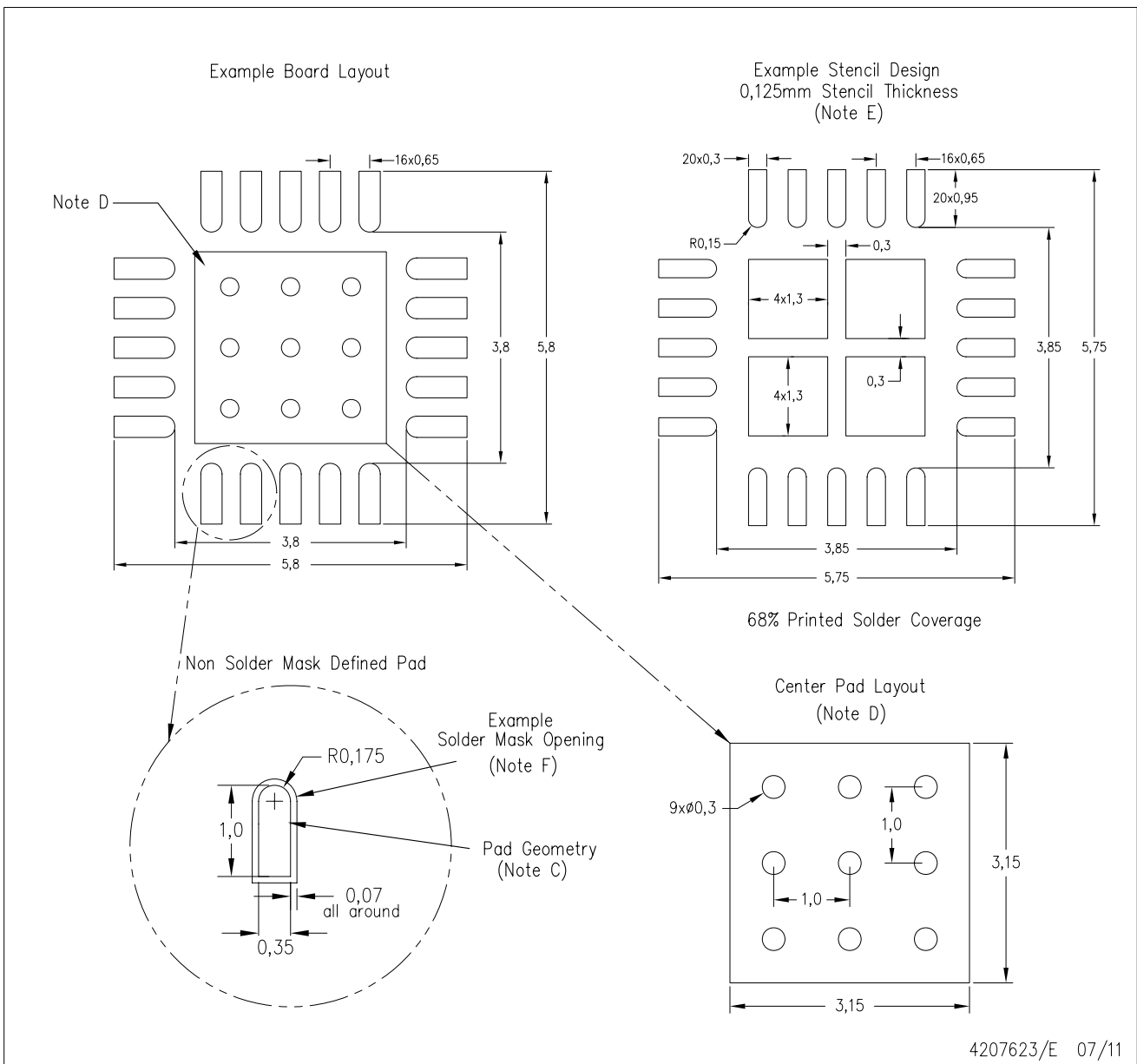

- NOTES:
- All linear dimensions are in millimeters.
 - This drawing is subject to change without notice.
 - Publication IPC-7351 is recommended for alternate designs.
 - This package is designed to be soldered to a thermal pad on the board. Refer to Application Note, QFN Packages, Texas Instruments Literature No. SLUA271, and also the Product Data Sheets for specific thermal information, via requirements, and recommended board layout. These documents are available at www.ti.com <<http://www.ti.com>>.
 - Laser cutting apertures with trapezoidal walls and also rounding corners will offer better paste release. Customers should contact their board assembly site for stencil design recommendations. Refer to IPC 7525 for stencil design considerations.
 - Customers should contact their board fabrication site for solder mask tolerances.

KC (R-PSFM-T7)

PLASTIC FLANGE-MOUNT PACKAGE

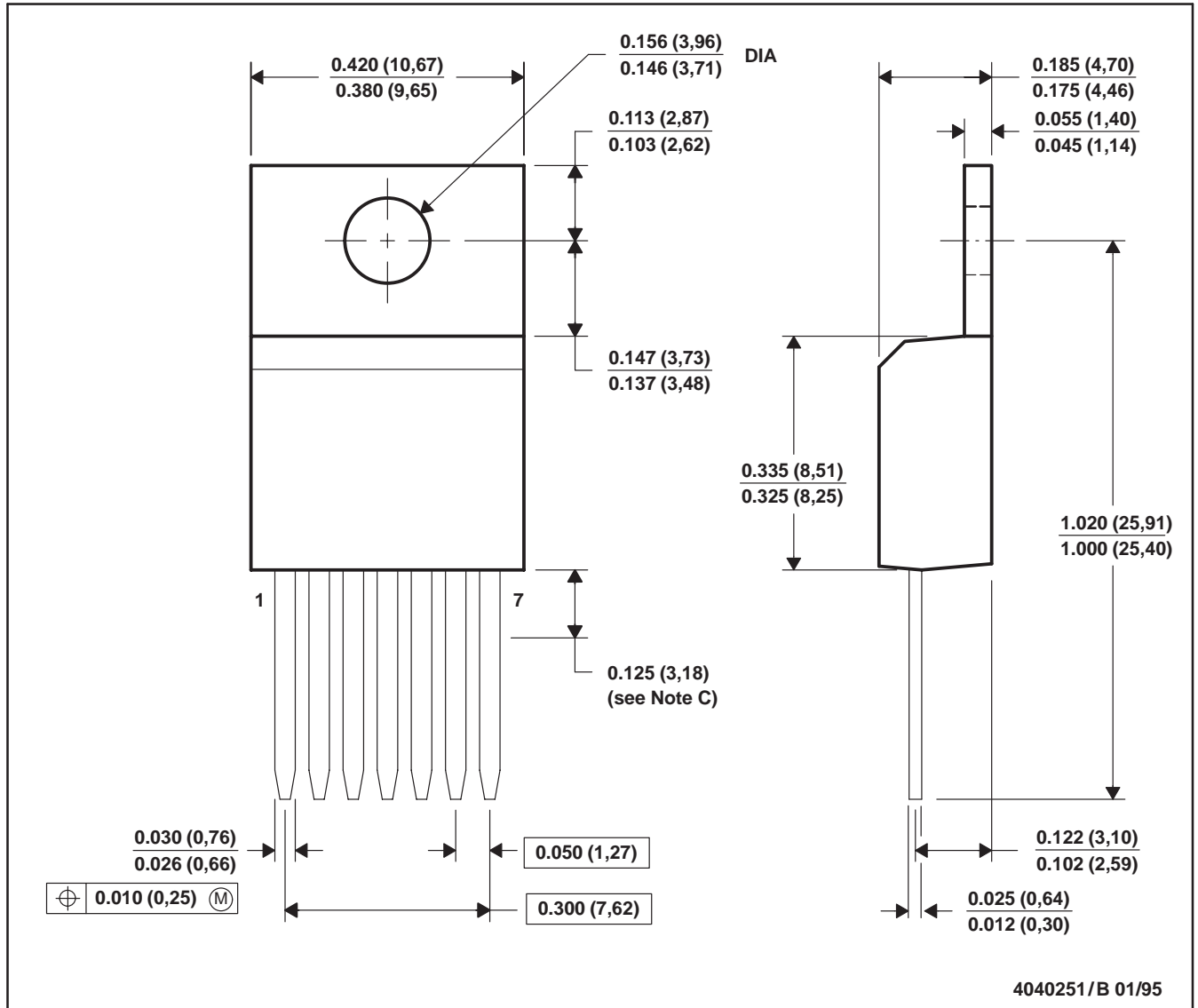

IMPORTANT NOTICE

Texas Instruments Incorporated and its subsidiaries (TI) reserve the right to make corrections, enhancements, improvements and other changes to its semiconductor products and services per JESD46C and to discontinue any product or service per JESD48B. Buyers should obtain the latest relevant information before placing orders and should verify that such information is current and complete. All semiconductor products (also referred to herein as "components") are sold subject to TI's terms and conditions of sale supplied at the time of order acknowledgment.

TI warrants performance of its components to the specifications applicable at the time of sale, in accordance with the warranty in TI's terms and conditions of sale of semiconductor products. Testing and other quality control techniques are used to the extent TI deems necessary to support this warranty. Except where mandated by applicable law, testing of all parameters of each component is not necessarily performed.

TI assumes no liability for applications assistance or the design of Buyers' products. Buyers are responsible for their products and applications using TI components. To minimize the risks associated with Buyers' products and applications, Buyers should provide adequate design and operating safeguards.

TI does not warrant or represent that any license, either express or implied, is granted under any patent right, copyright, mask work right, or other intellectual property right relating to any combination, machine, or process in which TI components or services are used. Information published by TI regarding third-party products or services does not constitute a license to use such products or services or a warranty or endorsement thereof. Use of such information may require a license from a third party under the patents or other intellectual property of the third party, or a license from TI under the patents or other intellectual property of TI.

Reproduction of significant portions of TI information in TI data books or data sheets is permissible only if reproduction is without alteration and is accompanied by all associated warranties, conditions, limitations, and notices. TI is not responsible or liable for such altered documentation. Information of third parties may be subject to additional restrictions.

Resale of TI components or services with statements different from or beyond the parameters stated by TI for that component or service voids all express and any implied warranties for the associated TI component or service and is an unfair and deceptive business practice. TI is not responsible or liable for any such statements.

Buyer acknowledges and agrees that it is solely responsible for compliance with all legal, regulatory and safety-related requirements concerning its products, and any use of TI components in its applications, notwithstanding any applications-related information or support that may be provided by TI. Buyer represents and agrees that it has all the necessary expertise to create and implement safeguards which anticipate dangerous consequences of failures, monitor failures and their consequences, lessen the likelihood of failures that might cause harm and take appropriate remedial actions. Buyer will fully indemnify TI and its representatives against any damages arising out of the use of any TI components in safety-critical applications.

In some cases, TI components may be promoted specifically to facilitate safety-related applications. With such components, TI's goal is to help enable customers to design and create their own end-product solutions that meet applicable functional safety standards and requirements. Nonetheless, such components are subject to these terms.

No TI components are authorized for use in FDA Class III (or similar life-critical medical equipment) unless authorized officers of the parties have executed a special agreement specifically governing such use.

Only those TI components which TI has specifically designated as military grade or "enhanced plastic" are designed and intended for use in military/aerospace applications or environments. Buyer acknowledges and agrees that any military or aerospace use of TI components which have **not** been so designated is solely at the Buyer's risk, and that Buyer is solely responsible for compliance with all legal and regulatory requirements in connection with such use.

TI has specifically designated certain components which meet ISO/TS16949 requirements, mainly for automotive use. Components which have not been so designated are neither designed nor intended for automotive use; and TI will not be responsible for any failure of such components to meet such requirements.

Products

Audio	www.ti.com/audio
Amplifiers	amplifier.ti.com
Data Converters	dataconverter.ti.com
DLP® Products	www.dlp.com
DSP	dsp.ti.com
Clocks and Timers	www.ti.com/clocks
Interface	interface.ti.com
Logic	logic.ti.com
Power Mgmt	power.ti.com
Microcontrollers	microcontroller.ti.com
RFID	www.ti-rfid.com
OMAP Mobile Processors	www.ti.com/omap
Wireless Connectivity	www.ti.com/wirelessconnectivity

Applications

Automotive and Transportation	www.ti.com/automotive
Communications and Telecom	www.ti.com/communications
Computers and Peripherals	www.ti.com/computers
Consumer Electronics	www.ti.com/consumer-apps
Energy and Lighting	www.ti.com/energy
Industrial	www.ti.com/industrial
Medical	www.ti.com/medical
Security	www.ti.com/security
Space, Avionics and Defense	www.ti.com/space-avionics-defense
Video and Imaging	www.ti.com/video

TI E2E Community e2e.ti.com