

### FEATURES

- Guaranteed  $V_{os}$ : 500  $\mu$ V maximum**
- Guaranteed matched CMRR: 94 dB minimum**
- Guaranteed matched  $V_{os}$ : 750  $\mu$ V maximum**
- LM148/LM348 direct replacement**
- Low noise**
- Silicon-nitride passivation**
- Internal frequency compensation**
- Low crossover distortion**
- Continuous short-circuit protection**
- Low input bias current**

### GENERAL DESCRIPTION

The OP11 provides four matched 741-type operational amplifiers in a single 14-lead PDIP. The OP11 is pin compatible with the LM148, LM348, RM4156, RM4158, and HA4741 amplifiers. The amplifier is matched for common-mode rejection ratio and offset voltage, which is very important in designing instrumentation amplifiers. In addition, the amplifier is designed to have equal positive-going and negative-going slew rates, which is an important consideration for good audio system performance.

The OP11 is ideal for use in designs requiring minimum space and cost while maintaining performance.

### PIN CONFIGURATION

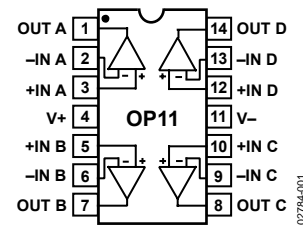

Figure 1. 14-Lead PDIP (N-14)  
(P Suffix)

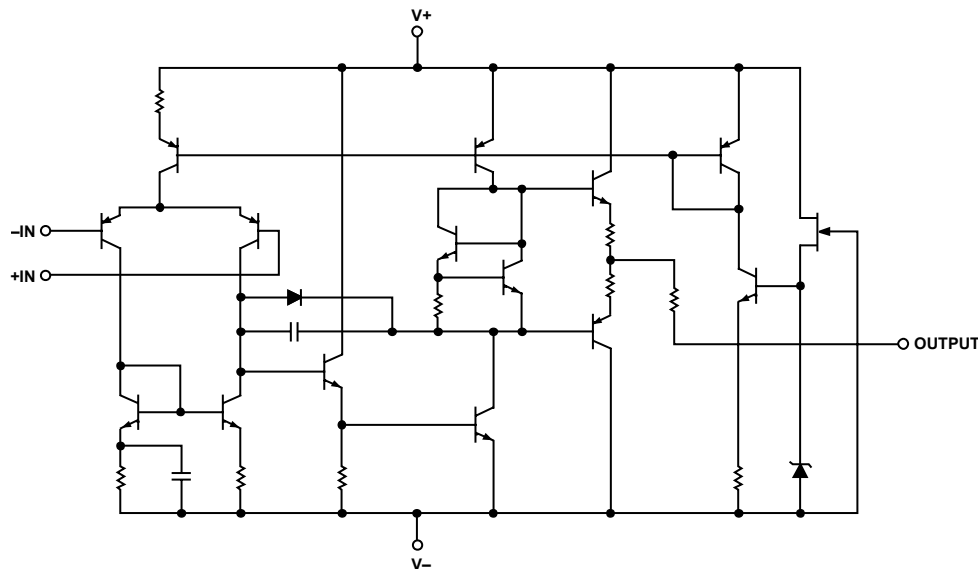

Figure 2. Simplified Schematic

### Rev. B

Information furnished by Analog Devices is believed to be accurate and reliable. However, no responsibility is assumed by Analog Devices for its use, nor for any infringements of patents or other rights of third parties that may result from its use. Specifications subject to change without notice. No license is granted by implication or otherwise under any patent or patent rights of Analog Devices. Trademarks and registered trademarks are the property of their respective owners.

**TABLE OF CONTENTS**

Features .....	1	Matching Characteristics.....	4
General Description .....	1	Absolute Maximum Ratings .....	5
Pin Configuration.....	1	ESD Caution.....	5
Revision History .....	2	Typical Performance Characteristics .....	6
Specifications.....	3	Outline Dimensions .....	9
Electrical Characteristics .....	3	Ordering Guide .....	9

**REVISION HISTORY**

**6/07—Rev. A to Rev. B**

Updated Format .....	Universal
Deleted 14-Lead Hermetic DIP/CERDIP .....	Universal
Changes to Table 1 .....	3
Deleted Table 3; Renumbered Sequentially .....	3
Changes to Table 2, Layout, Table 3, and Table 4 .....	4
Changes to Table 5 and Table 6.....	5
Changes to Figure 17.....	8
Updated Outline Dimensions .....	9
Changes to Ordering Guide .....	9

**4/02—Rev. 0 to Rev. A**

Change OP-09/OP-11 to OP11 .....	Global
Edits to Pin Connections .....	1
Edits to Figure 1 .....	1
Edits to Absolute Maximum Ratings .....	2
Edits to Ordering Guide .....	2
Edits to Spec Tables .....	2-4
Deletion of Dice Characteristics.....	5
Deletion of Wafer Test Limits Table .....	5
Deletion of Typical Electrical Characteristics Table .....	5

# SPECIFICATIONS

## ELECTRICAL CHARACTERISTICS

$V_S = \pm 15\text{ V}$ ,  $T_A = 25^\circ\text{C}$ , unless otherwise noted.

Table 1.

Parameter	Symbol	Conditions	Min	Typ	Max	Unit
Input Offset Voltage	$V_{OS}$	$R_S \leq 10\text{ k}\Omega$		0.3	0.5	mV
Input Offset Current	$I_{OS}$			5.5	20	nA
Input Bias Current	$I_B$			180	300	nA
Input Resistance Differential Mode <sup>1</sup>	$R_{IN}$		0.17	0.29		M $\Omega$
Input Voltage Range	IVR		$\pm 12$	$\pm 13$		V
Common-Mode Rejection Ratio	CMRR	$V_{CM} = \pm 12\text{ V}$ , $R_S \leq 10\text{ k}\Omega$	100	120		dB
Power Supply Rejection Ratio	PSRR	$V_S = \pm 5\text{ V}$ to $\pm 15\text{ V}$ , $R_S \leq 10\text{ k}\Omega$		4	32	$\mu\text{V/V}$
Output Voltage Swing	$V_O$	$R_L = 2\text{ k}\Omega$	$\pm 11$	$\pm 13$		V
Large Signal Voltage Gain	$A_{VO}$	$R_L \leq 2\text{ k}\Omega$ , $V_O = \pm 10\text{ V}$	100	650		V/mV
Power Consumption <sup>2</sup>	$P_d$	$V_O = 0\text{ V}$		105	180	mW
Input Noise Voltage	$e_n$ p-p	0.1 Hz to 10 Hz		0.7		$\mu\text{V p-p}$
Input Noise Voltage Density	$e_n$	$f_o = 10\text{ Hz}$		18		nV/ $\sqrt{\text{Hz}}$
		$f_o = 100\text{ Hz}$		14		nV/ $\sqrt{\text{Hz}}$
		$f_o = 1\text{ kHz}$		12		nV/ $\sqrt{\text{Hz}}$
Input Noise Current	$i_n$ p-p	0.1 Hz to 10 Hz		17		pA p-p
Input Noise Current Density	$i_n$	$f_o = 10\text{ Hz}$		1.8		pA/ $\sqrt{\text{Hz}}$
		$f_o = 100\text{ Hz}$		1.5		pA/ $\sqrt{\text{Hz}}$
		$f_o = 1\text{ kHz}$		1.2		pA/ $\sqrt{\text{Hz}}$
Channel Separation	CS		100	130		dB
Slew Rate <sup>3</sup>	SR		0.7	1.0		V/ $\mu\text{s}$
Large Signal Bandwidth <sup>3</sup>		$V_O = 20\text{ V p-p}$	11	16		kHz
Closed-Loop Bandwidth <sup>4</sup>	BW	$A_{VCL} = 1$	2.4	3.0		MHz
Rise Time <sup>3</sup>	$t_r$	$A_V = 1$ , $V_{IN} = 50\text{ mV}$		110	145	ns
Overshoot <sup>3</sup>	OS			15	25	%

<sup>1</sup> Guaranteed by input bias current.

<sup>2</sup> Total dissipation for all four amplifiers in package.

<sup>3</sup> Sample tested.

<sup>4</sup> Guaranteed by rise time.

# OP11

$V_S = \pm 15\text{ V}$ ,  $0^\circ\text{C} \leq T_A \leq 70^\circ\text{C}$ , unless otherwise noted.

**Table 2.**

Parameter	Symbol	Conditions	Min	Typ	Max	Unit
Input Offset Voltage	$V_{OS}$	$R_S \leq 10\text{ k}\Omega$		0.4	0.8	mV
Average Input Offset Voltage Drift <sup>1</sup>	$TCV_{OS}$	$R_S \leq 10\text{ k}\Omega$		2.0	10	$\mu\text{V}/^\circ\text{C}$
Input Offset Current	$I_{OS}$			14	30	nA
Average Input Offset Current Drift <sup>1</sup>	$TCI_{OS}$			0.1	0.3	$\text{nA}/^\circ\text{C}$
Input Bias Current	$I_B$			200	350	nA
Input Voltage Range	IVR		$\pm 12$	$\pm 13$		V
Common-Mode Rejection Ratio	CMRR	$V_{CM} = \pm 12\text{ V}$ , $R_S \leq 10\text{ k}\Omega$	100	120		dB
Power Supply Rejection Ratio	PSRR	$V_S = \pm 5\text{ V}$ to $\pm 15\text{ V}$ , $R_S \leq 10\text{ k}\Omega$		4	32	$\mu\text{V}/\text{V}$
Large Signal Voltage Gain	$A_{VO}$	$R_L \geq 2\text{ k}\Omega$ , $V_O = \pm 10\text{ V}$	50	250		V/mV
Output Voltage Swing	$V_O$	$R_L \geq 2\text{ k}\Omega$	$\pm 11$	$\pm 13$		V
Power Consumption <sup>2</sup>	$P_d$	$V_O = 0\text{ V}$		115	200	mW

<sup>1</sup> Guaranteed but not tested.

<sup>2</sup> Total dissipation for all four amplifiers in package.

## MATCHING CHARACTERISTICS

$V_S = \pm 15\text{ V}$ ,  $T_A = 25^\circ\text{C}$ ,  $R_S \leq 100\ \Omega$ , unless otherwise noted.

**Table 3.**

Parameter	Symbol	Conditions	Min	Typ	Max	Unit
Input Offset Voltage Match	$\Delta V_{OS}$			0.5	0.75	mV
Common-Mode Rejection Ratio Match	$\Delta\text{CMRR}$	$V_{CM} = \pm 12\text{ V}$		1	20	$\mu\text{V}/\text{V}$
		$V_{CM} = \pm 12\text{ V}$	94	120		dB

$V_S = \pm 15\text{ V}$ ,  $0^\circ\text{C} \leq T_A \leq 70^\circ\text{C}$ ,  $R_S \leq 100\ \Omega$ , unless otherwise noted.

**Table 4.**

Parameter	Symbol	Conditions	Min	Typ	Max	Unit
Input Offset Voltage Match	$\Delta V_{OS}$			0.6	1.0	mV
Common-Mode Rejection Ratio Match	$\Delta\text{CMRR}$	$V_{CM} = \pm 12\text{ V}$		3.2	20	$\mu\text{V}/\text{V}$
		$V_{CM} = \pm 12\text{ V}$	94	110		dB

## ABSOLUTE MAXIMUM RATINGS

Table 5.

Parameter	Rating
Supply Voltage (V <sub>s</sub> )	±22 V
Differential Input Voltage	±30 V
Input Voltage	Supply Voltage
Output Short-Circuit Duration	Continuous (One Amp Only)
Storage Temperature Range	-65°C to +125°C
Lead Temperature (Soldering, 60 sec)	300°C
Operating Temperature Range	0°C to 70°C

Stresses above those listed under Absolute Maximum Ratings may cause permanent damage to the device. This is a stress rating only; functional operation of the device at these or any other conditions above those indicated in the operational section of this specification is not implied. Exposure to absolute maximum rating conditions for extended periods may affect device reliability.

Table 6. Thermal Resistance

Package Type	$\theta_{JA}$ <sup>1</sup>	$\theta_{JC}$	Unit
14-Lead PDIP (N-14)	83	39	°C/W

<sup>1</sup>  $\theta_{JA}$  is specified for worst-case conditions, that is,  $\theta_{JA}$  is specified for device in socket for PDIP.

### ESD CAUTION



**ESD (electrostatic discharge) sensitive device.** Charged devices and circuit boards can discharge without detection. Although this product features patented or proprietary protection circuitry, damage may occur on devices subjected to high energy ESD. Therefore, proper ESD precautions should be taken to avoid performance degradation or loss of functionality.

TYPICAL PERFORMANCE CHARACTERISTICS

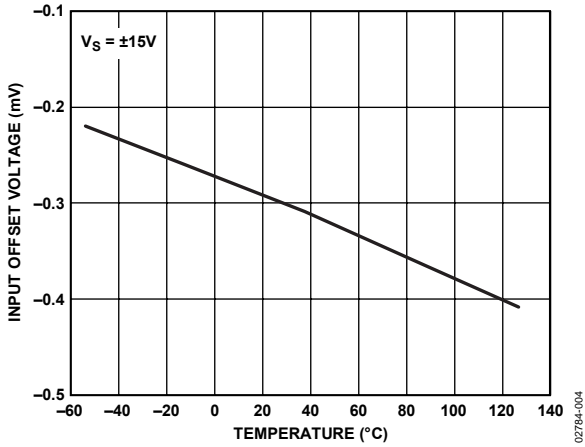

Figure 3. Input Offset Voltage vs. Temperature

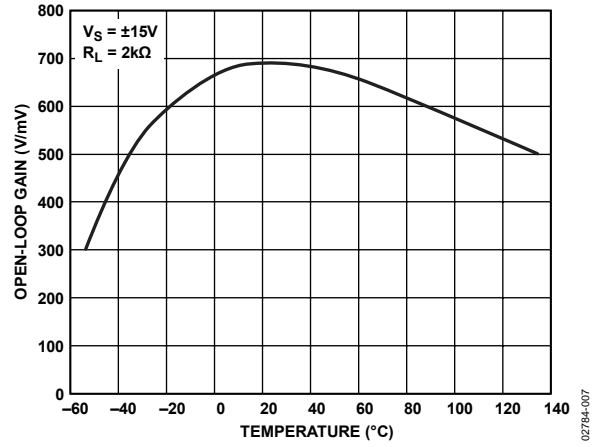

Figure 6. Open-Loop Gain vs. Temperature

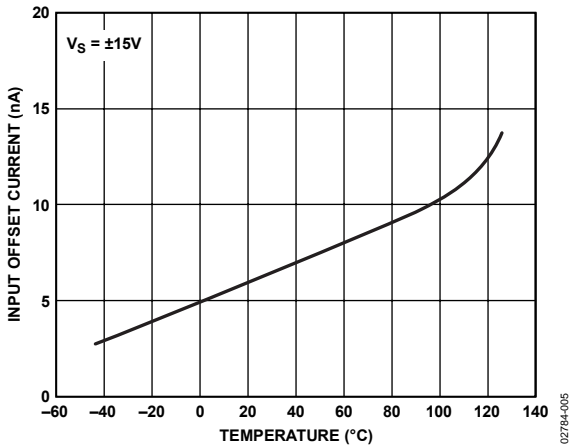

Figure 4. Input Offset Current vs. Temperature

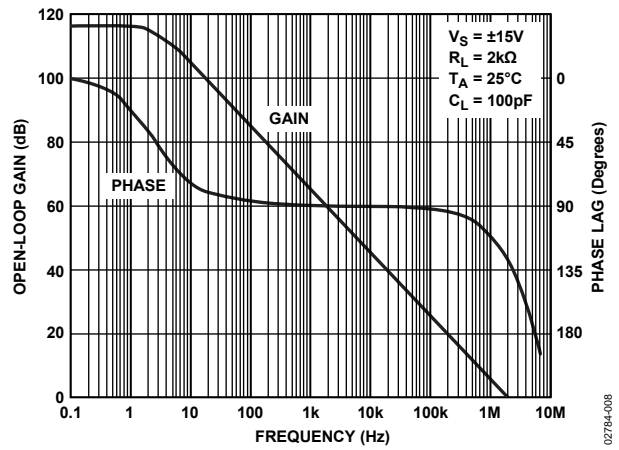

Figure 7. Open-Loop Gain and Phase vs. Frequency

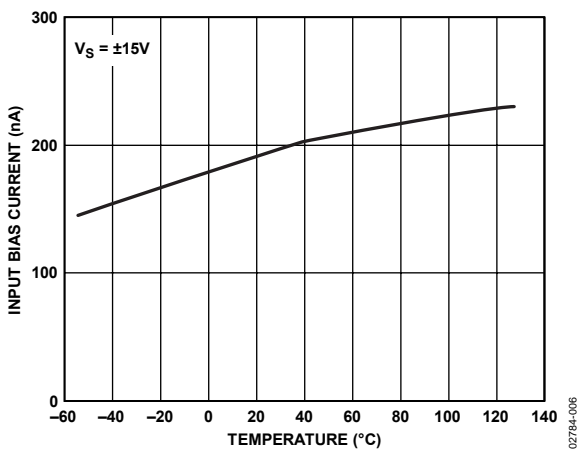

Figure 5. Input Bias Current vs. Temperature

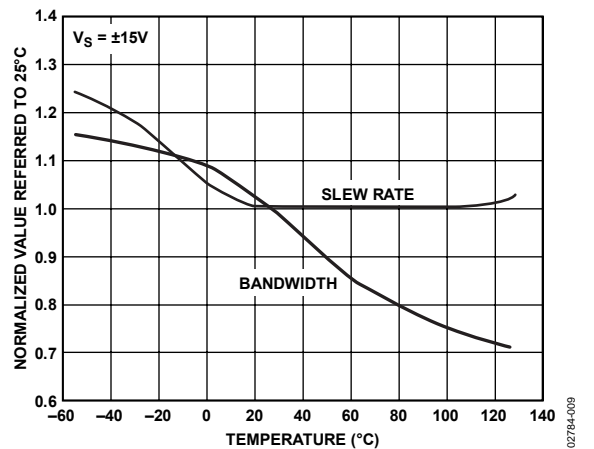

Figure 8. Normalized Slew Rate and Bandwidth vs. Temperature

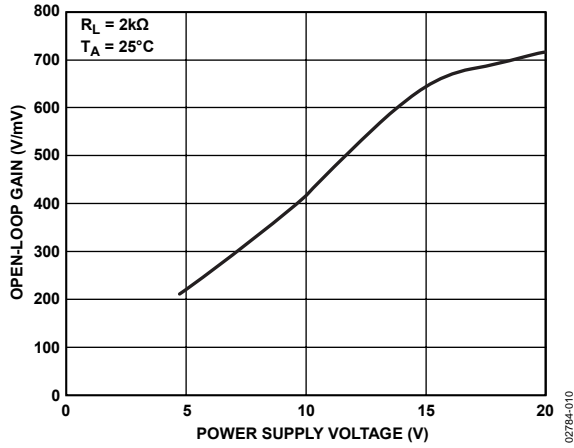

Figure 9. Open-Loop Gain vs. Power Supply Voltage

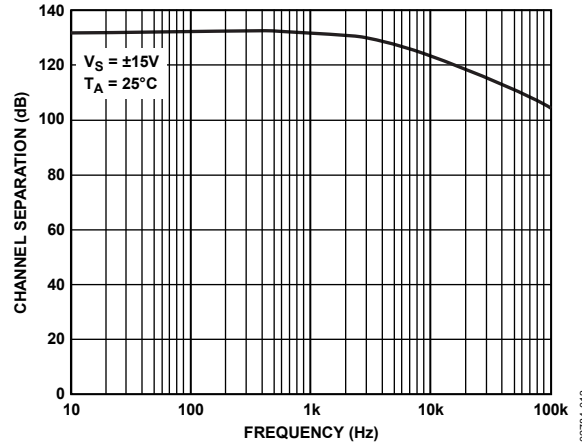

Figure 12. Channel Separation vs. Frequency

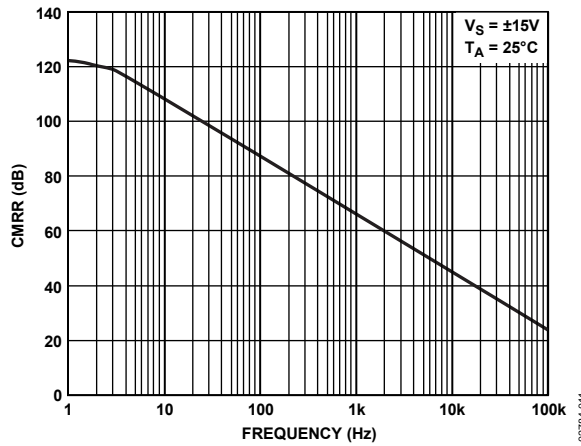

Figure 10. CMRR vs. Frequency

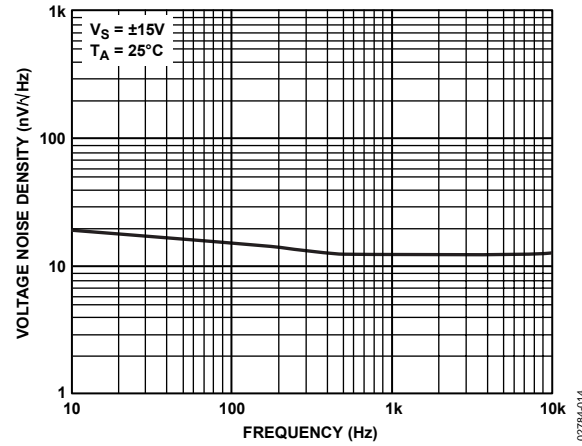

Figure 13. Voltage Noise Density vs. Frequency

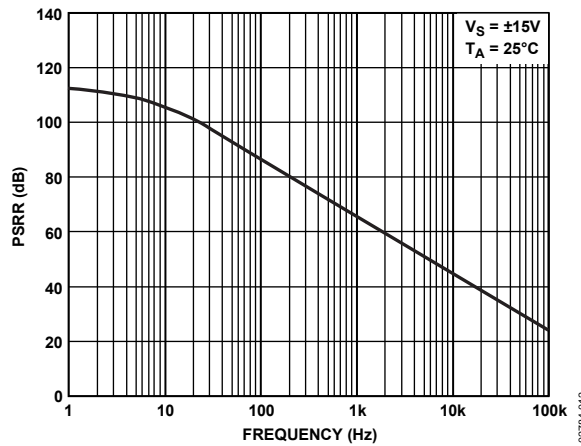

Figure 11. PSRR vs. Frequency

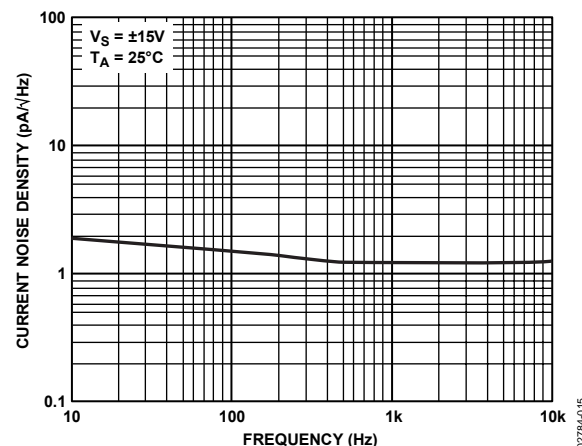

Figure 14. Current Noise Density vs. Frequency

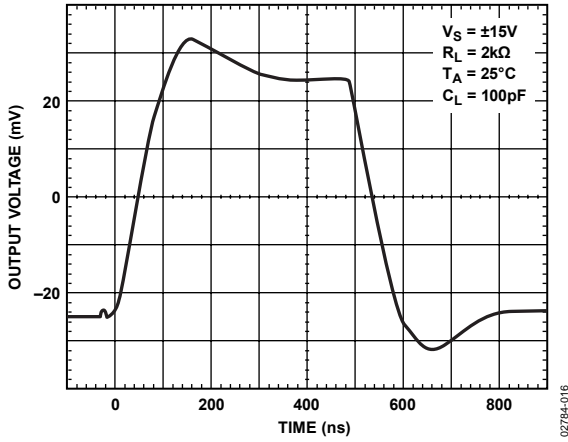

Figure 15. Transient Response

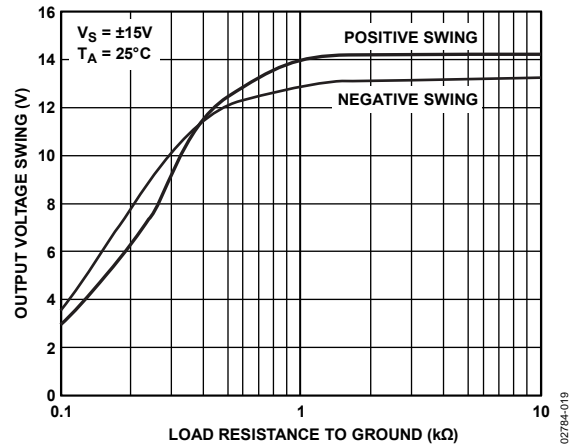

Figure 18. Output Voltage Swing vs. Load Resistance

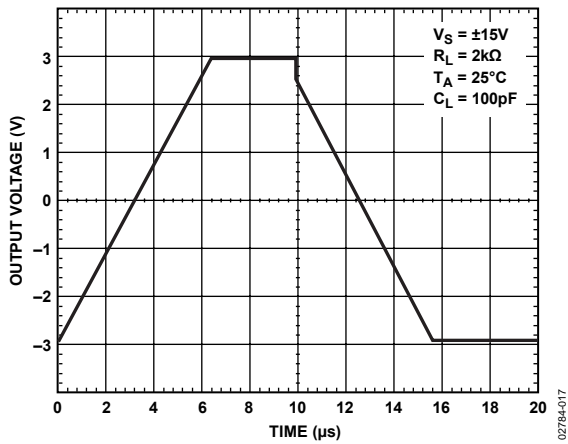

Figure 16. Voltage Follower Pulse Response

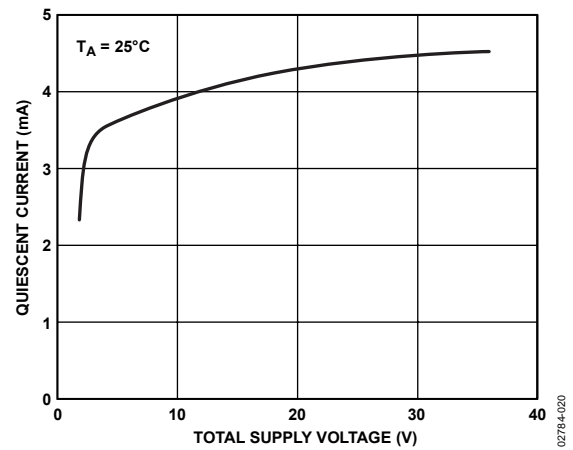

Figure 19. Quiescent Current vs. Total Supply Voltage

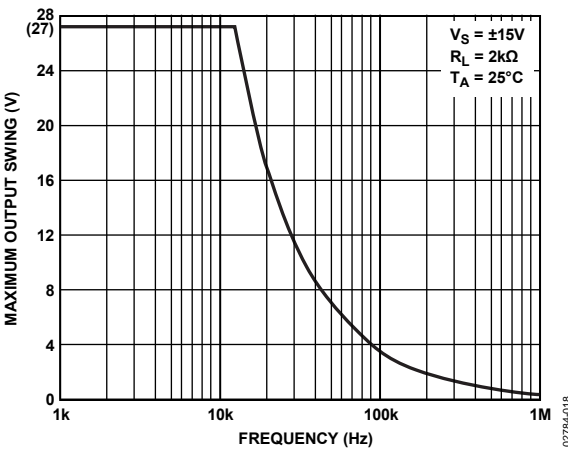

Figure 17. Maximum Output Swing vs. Frequency

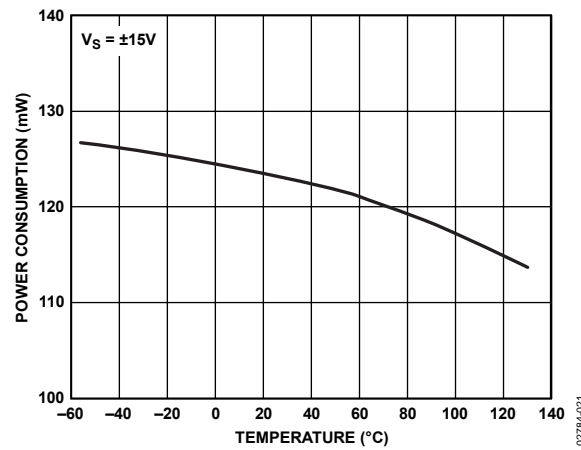
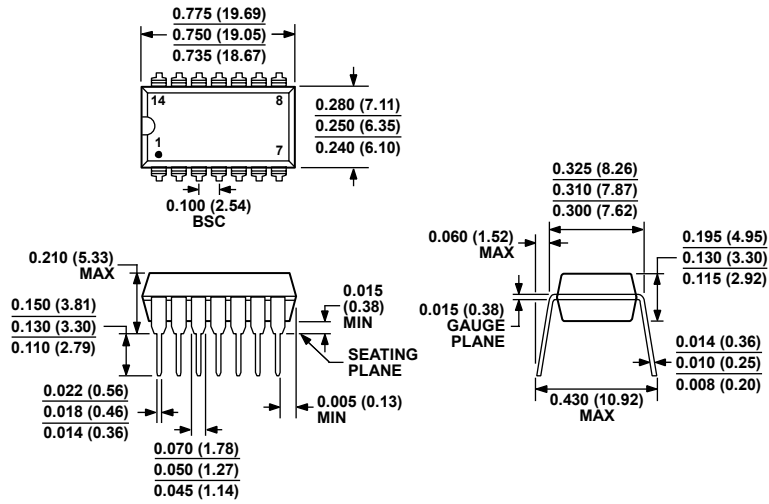

Figure 20. Power Consumption vs. Temperature



# OUTLINE DIMENSIONS



COMPLIANT TO JEDEC STANDARDS MS-001  
 CONTROLLING DIMENSIONS ARE IN INCHES; MILLIMETER DIMENSIONS (IN PARENTHESES) ARE ROUNDED-OFF INCH EQUIVALENTS FOR REFERENCE ONLY AND ARE NOT APPROPRIATE FOR USE IN DESIGN. CORNER LEADS MAY BE CONFIGURED AS WHOLE OR HALF LEADS.

Figure 21. 14-Lead Plastic Dual In-Line Package [PDIP]  
 (N-14)  
 [P Suffix]  
 Dimensions shown in inches and (millimeters)

070606-A

## ORDERING GUIDE

Model	Temperature Range	Package Description	Package Option
OP11EP	0°C to 70°C	14-Lead Plastic Dual In-Line Package (PDIP)	N-14 (P-Suffix)
OP11EPZ <sup>1</sup>	0°C to 70°C	14-Lead Plastic Dual In-Line Package (PDIP)	N-14 (P-Suffix)

<sup>1</sup> Z = RoHS Compliant Part.

For military processed devices, refer to the Standard Microcircuit Drawing (SMD) available at <http://www.dsccl.dla.mil/downloads/Milspec/Smd/89801.pdf>.

SMD Part Number	Analog Devices, Inc. Equivalent
5962-89801012A	OP11ARCMDA
5962-8980101CA	OP11AYMDA

**OP11**

**NOTES**

**NOTES**

**OP11**

**NOTES**

# Mouser Electronics

Authorized Distributor

Click to View Pricing, Inventory, Delivery & Lifecycle Information:

[Analog Devices Inc.:](#)

[5962-8980101CA](#) [OP11EPZ](#) [5962-89801012A](#)