

THICK-FILM CHIP RESISTOR

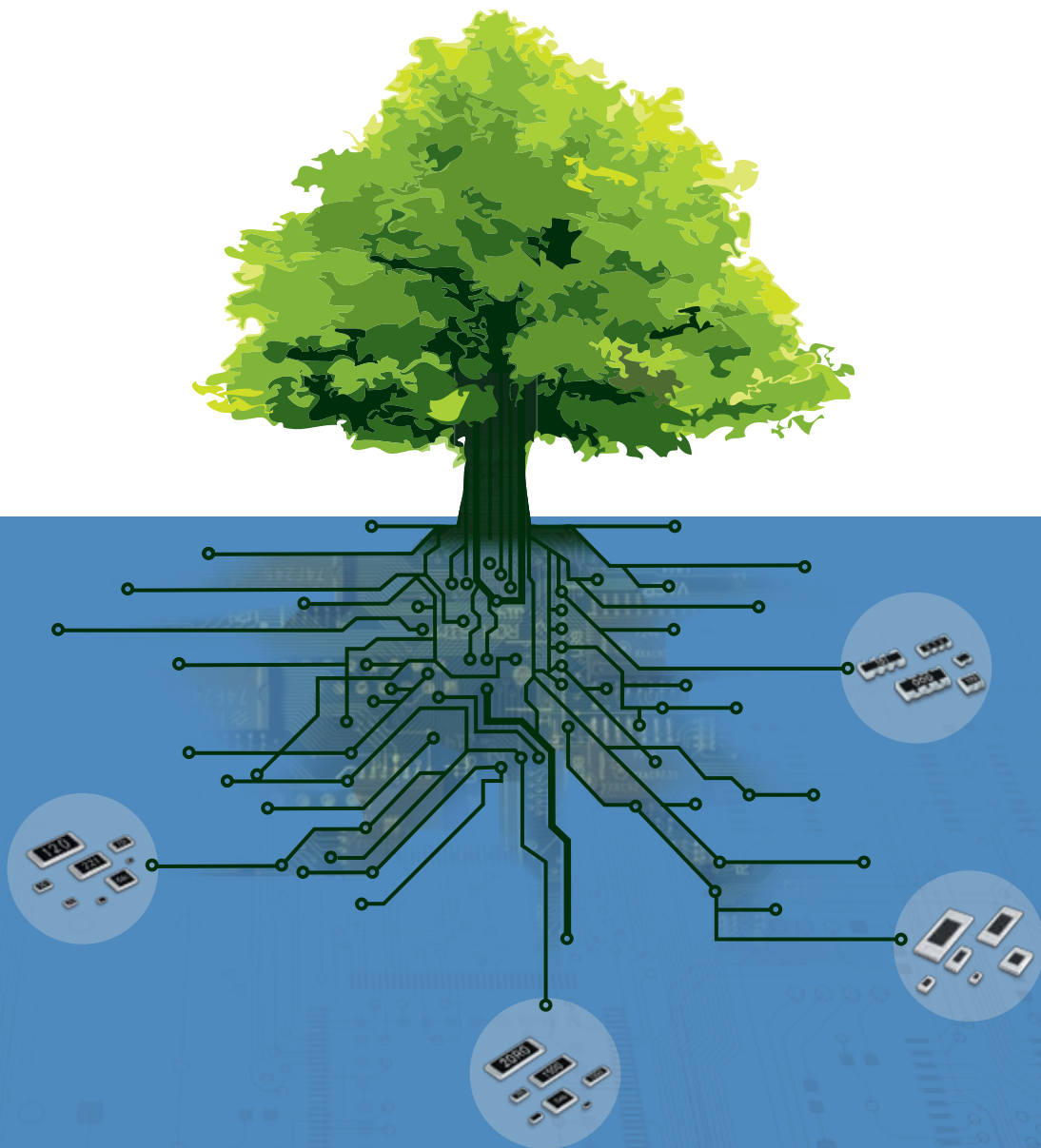



We, Samsung, declare that our component Chip Resistor is produced in accordance with EU RoHS directive.

1. RoHS Compliance and restriction of Br

The following restricted materials are not used in packaging materials as well as products in compliance with the law and restriction.

- Cd, Pb, Hg, Cr6+, As, Br and the compounds, PCB, asbestos
- Bromic materials : PBBs, PBBOs, PBDO, PBDE, PBB

2. No use of materials breaking Ozone layer

The following ODS materials are not used in our fabrication process.

- ODS material : Freon, Haron, 1-1-1 TCE, CCl4, HCFC

If you want more detailed Information, Please Visit Samsung Electro-mechanics Website
[<http://www.sem.samsung.com>, <http://www.semlcr.com>]

CONTENTS

| | | |
|---|----|---|
| Operation Notes | 4 | Operation Notes |
| Example of land Pattern Design | 5 | Example of land Pattern Design |
| Recommended Soldering Conditions | 6 | Recommended Soldering Conditions |
| General Structure | 7 | General Structure |
| General | 8 | General |
| Low ohms(RUT Series) | 10 | Low ohms (RUT Series) |
| Ultra Low ohms(RU Series) | 12 | Ultra Low ohms (RU Series) |
| Ultra Low Ohms(RUK Series) | 14 | Ultra Low Ohms (RUK Series) |
| Ultra Low Ohms(RJ Series) | 16 | Ultra Low Ohms (RJ Series) |
| Arrays(Convex Type) | 18 | Arrays (Convex Type) |
| Arrays(Concave Type) | 20 | Arrays (Concave Type) |
| Arrays(Flat Type) | 22 | Arrays (FlatType) |
| Anti-Sulfur Resistors | 24 | Anti-Sulfur Resistors |
| Anti-Sulfur Resistor Arrays(Convex Type) | 26 | Anti-Sulfur Resistor Arrays(Convex Type) |
| Anti-Sulfur Resistor Arrays(Concave Type) | 28 | Anti-Sulfur Resistor Arrays(Concave Type) |
| Anti-Sulfur Resistor Arrays (Flat Type) | 30 | Anti-Sulfur Resistor Arrays (Flat Type) |
| Automotive Anti-sulfur | 32 | Automotive Anti-sulfur |
| Automotive Anti-sulfur Arrays (Convex Type) | 34 | Automotive Anti-sulfur Arrays (Convex Type) |
| Attenuator | 36 | Attenuator |
| Characteristics Performance | 38 | Characteristics Performance |
| Packaging | 40 | Packaging |
| Standard Resistance Value | 42 | Standard Resistance Value |

Operation Notes

Applications

- Chip resistors are designed for general electronic devices such as home appliances, computer, mobile communications, digital circuit, etc. If you require our products with high reliability-performing at more than 125°C or below -55°C - for medical equipments, aircrafts, high speed machines, military usage, and items that can affect human life or if you need to use in specific conditions (corrosive gas atmosphere like H₂S etc.), please contact us beforehand.
- Normal operation temperature ranges (°C): -55°C ~+155°C
- Others (small sizes and flat type arrays) : -55°C ~+125°C
- Although resistor body is coated, sharp excessive impact should be avoided to prevent damages and adverse effects on characteristics (resistor value, open circuited, T.C.R.).

Mounting

Please give more attention not to press the chip owing to the nozzle's improper height when it is mounted on PCB. (Excessive pressure may cause exterior damage, change in resistance, circuit open, etc.)

Safety precautions

- These products are designed and produced for applying to the ordinary electronic equipments. (AV equipment, OA equipment, Telecommunication equipment, etc)
- Consult with our sales department before applying in the devices that require extremely high reliability such as medical equipments, transport equipments, aircrafts /spacecrafts, nuclear power controllers, fuel controllers, car equipments including car accessories and other safety devices.
- Following special environments, and such environmental conditions may affect the performance of the product. Please verify the performance and reliability thoroughly prior to use.
 - a) Using in various type of Liquid including water, oil, organic solvent and other chemicals.
 - b) Using in the places where the products are exposed to direct sunlight, sea wind, corrosive gases (including Cl₂, H₂S, NH₃, SO₂, NO₂), static electricity, electromagnetic waves and dusty air.
 - c) Using close to heat generating components or other flammable items.
 - d) Using in the places that is sealed or coated with resins or other coating materials after soldering.
 - e) Using in places subject to dew condensation.
- These products are not radiation resistant.
- The company is not responsible for any problems resulting from using of the products under the conditions not recommended herein.
- The company should notify any safety issues of the products to the customer. And the safety of the products should be monitored by the customer periodically.

Storage

To maintain proper quality of chip components, the following precautions are required for storage environment, method and period.

- Storage Environment
 - Make sure that the ambient temperature is within 5°C ~40°C and the ambient humidity is within 20~70%RH.
 - Chip components may be deformed, if the temperature of packaged components exceeds 40°C .
 - Do not store where the soldering properties can be deteriorated by harmful gas such as sulphurous gas, chlorine gas, etc.
 - Bulk packed chip components should be used as soon as the seal is opened, thus preventing the solderability from deteriorating.
 - The remaining unused chips should be put in the original bag and sealed again or store in a desiccator containing a desiccating agent.
- Storage Time Period
 - Stored chip components should be used within 6 months after receiving the components. If 6 months or more have elapsed, please check the solderability before actually using.

Cleaning

After Soldering Cleaning, soldering flux & Ionic cleaning liquid should be avoided on product.

If any possibility on product, please take a test before usage.

Caution for Chip Resistor Separation from PCB.

Chip resistor installation on PCB is a similar phenomenon on a chocolate chip on top of a cake. PCB has enough flexibility on outer force but Chip resistor can be defected without any bending. (By chip resistor use of Ceramic, solder, metal) Therefore, when separating a Chip resistor from a PCB, beware of any crack on the chip.

Others

- Manual work
 - Whenever separating chip resistor from PCB, do not re-use the chip resistor for circuit safety.
 - Electrical specification of chip resistors can be changed by soldering iron after separation.
 - Re-use of separated chip resistor should be prohibited.
- Do not use more than rated voltage. (Please check the contents of each product)

Example of Land Pattern Design

- When designing P.C.B, the shape and size of the solder lands must allow a proper amount of solder to form under the resistor. The amount of solder formed at the end terminations has direct effect on the possibility of chip crack. The more the amount of solder and stress, the more the possibilities of chip crack.

For Chip Type

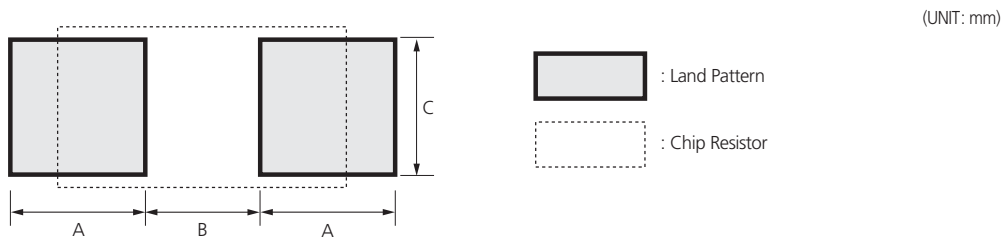

• Reflow Soldering(RC, RCA, RCM, RUT)

| Type | A | B | 2A+B | C |
|------|------|------|------|------|
| 0402 | 0.17 | 0.20 | 0.54 | 0.18 |
| 0603 | 0.37 | 0.28 | 1.02 | 0.29 |
| 1005 | 0.6 | 0.5 | 1.7 | 0.5 |
| 1608 | 0.8 | 0.8 | 2.4 | 0.8 |
| 2012 | 0.9 | 1.4 | 3.2 | 1.2 |
| 3216 | 1.3 | 1.8 | 4.4 | 1.5 |
| 3225 | 1.3 | 1.8 | 4.4 | 2.4 |
| 5025 | 1.4 | 3.3 | 6.1 | 2.4 |
| 6432 | 1.4 | 4.6 | 7.4 | 3.0 |

• Reflow Soldering(RU, RUK)

| Type | A | B | 2A+B | C |
|------|------|-----|------|-----|
| 1005 | 0.8 | 0.5 | 2.1 | 0.5 |
| 1608 | 0.8 | 0.5 | 2.1 | 0.8 |
| 2012 | 0.9 | 0.8 | 2.6 | 1.2 |
| 3216 | 1.7 | 1.2 | 4.6 | 1.4 |
| 3225 | 1.7 | 1.2 | 4.6 | 2.4 |
| 5025 | 2.15 | 1.8 | 6.1 | 2.6 |
| 6432 | 2.3 | 3.0 | 7.6 | 3.3 |

• Reflow Soldering(RJ, RW)

| Type | A | B | 2A+B | C |
|-------|-----|-----|------|-----|
| *0816 | 0.5 | 0.3 | 1.3 | 1.6 |
| 1220 | 0.7 | 0.4 | 1.8 | 2.0 |
| 1632 | 1.1 | 0.6 | 2.8 | 3.3 |
| 2037 | 1.4 | 1.2 | 4.0 | 3.8 |
| *3264 | 2.0 | 1.6 | 5.6 | 6.5 |

For Array Type

• Convex type

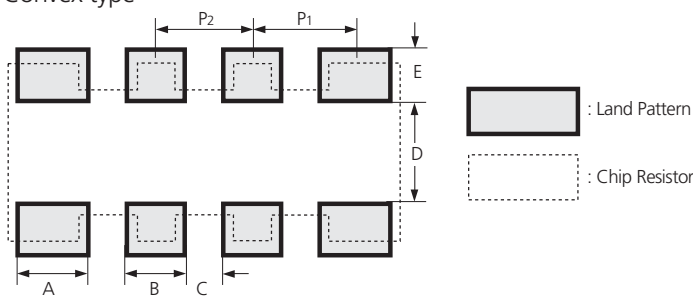

| Type | A | B | C | D | E | P1 | P2 |
|------|------|------|------|------|------|------|------|
| 062P | 0.20 | 0.20 | 0.30 | 0.30 | 0.30 | 0.50 | - |
| 064P | 0.20 | 0.20 | 0.20 | 0.30 | 0.30 | 0.40 | 0.40 |
| 10AT | 0.4 | 0.4 | 0.25 | 0.5 | 0.5 | 0.65 | - |
| 102P | 0.4 | 0.4 | 0.25 | 0.5 | 0.5 | 0.65 | - |
| 104P | 0.5 | 0.3 | 0.2 | 0.5 | 0.5 | 0.55 | 0.5 |
| 164P | 0.7 | 0.5 | 0.3 | 0.9 | 0.8 | 0.9 | 0.8 |

• Concave type

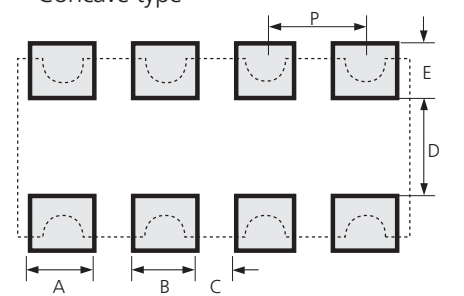

| Type | A | B | C | D | E | P |
|------|-----|-----|-----|-----|-----|-----|
| 102P | 0.3 | 0.3 | 0.2 | 0.5 | 0.4 | 0.5 |
| 104P | 0.3 | 0.3 | 0.2 | 0.5 | 0.4 | 0.5 |

- This is the recommended land pattern for designing PCB. This pattern does not guarantee any characteristic of other product.

The specifications and designs contained herein may be subject to change without notice. Please contact our sales representatives or product engineers before order.

Operation Notes

Example of land Pattern Design

Recommended Soldering Conditions

General Structure

General

Low ohms (RUT Series)

Ultra Low ohms (RU Series)

Ultra Low Ohms (RUK Series)

Ultra Low Ohms (RJ Series)

Arrays (CONVEX Type)

Arrays (CONCAVE Type)

Arrays (FLAT Type)

Anti-Sulfur Resistors

Anti-Sulfur Resistor Arrays(Convex Type)

Anti-Sulfur Resistor Arrays(Concave Type)

Anti-Sulfur Resistor Arrays (Flat Type)

Automotive Anti-sulfur

Automotive Anti-sulfur Arrays (Convex Type)

Attenuator

Characteristics Performance

Packaging

Standard Resistance Value

Recommended Soldering Conditions

Abstract

- There are 3 soldering methods.
 - Flow(wave) soldering.
 - Reflow soldering. (Reflow soldering is broadly divided into the total heating method and local heating method.)
 - Iron soldering.

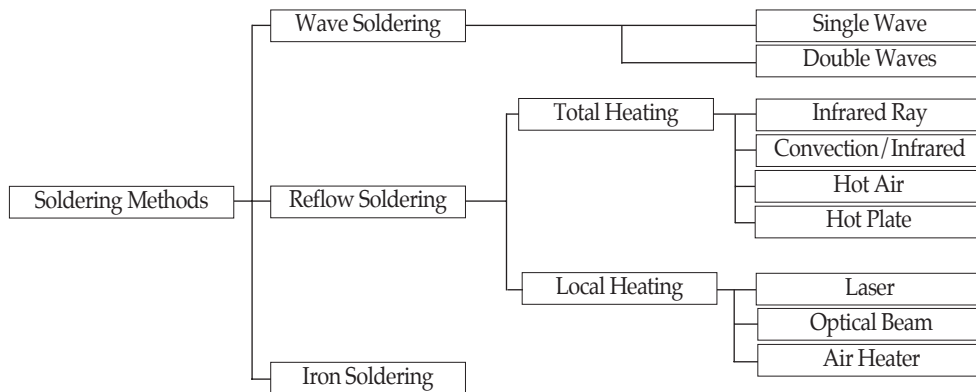

Since Chip resistors come into direct contact with melted solder during soldering, it is exposed to potential mechanical stress caused by the sudden temperature change. The chip resistors may also be subject to silver migration and flux contamination.

Flow(wave) Soldering

- Features

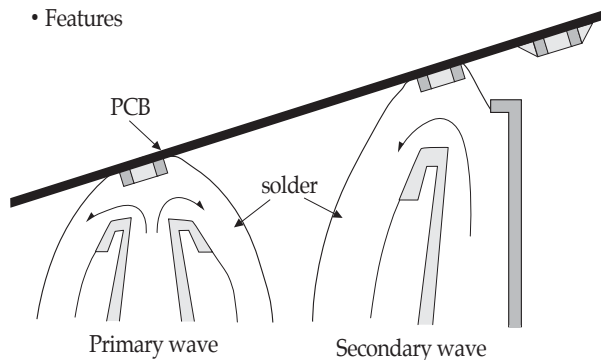

There are two types of soldering methods in flow(wave) soldering. One is single wave soldering, and the other is a double waves soldering. However, double waves soldering is mainly used. This method is designed for continuous and multiple dipping process by using primary and secondary wave, having completely different waveforms and characteristics.

With the primary wave, a comparatively strong jet flow is used to remove the flux gas and to solder.

With the secondary wave, it is used to remove excessive solder.

With the primary wave, the solder flows into a very small gap between components and air bubbles remaining on the soldered joint are removed.

With the secondary wave, the peel back is used to prevent bridging.

- Preheating

If a chip component is heated suddenly during soldering, it may crack by the thermal shock caused by the temperature difference between the surface and the inside of the chip. To prevent this, a full preheating is necessary. In case of wave soldering, the temperature difference between solder and surface of the component should be kept within 150°C. Also when cooling is done by dipping into solvent, care should be taken to keep the temperature difference within 150°C.

- Standard Soldering Condition

Soldering must be carried out without exceeding the approved soldering temperature and time shown within the shaded area of the graph at right. An excessively long soldering time or high soldering temperature results in leaching of outer terminations. When a PCB is warped, mechanical stress applied to the chip will be increased and might cause chip crack, especially if there is a big amount of solder on the chip. So, care should be taken not to use excessive amount of solder on the PCB.

For the flow(wave) soldering, the solder amount can be controlled by land size.

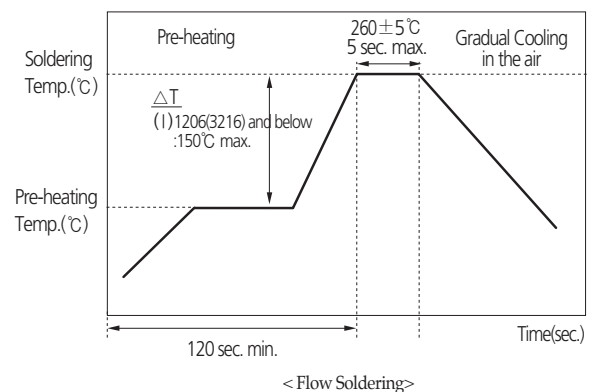

Reflow Soldering

• Pre-heating and cooling

In the reflow soldering method, a full pre-heating at the proper temperature is necessary to dry and activate solder paste. Tomb-stoning can be reduced by preheating at 150~180°C for more than 1 minute. Also when cooling is done by dipping into solvent, care should be taken to keep the temperature difference within 150°C.

• Standard Reflow Soldering Condition

Soldering must be carried out without exceeding the approved soldering temperature and time shown within the shaded area of the right graph. This prevents the terminations from leaching and characteristics from deteriorating. When soldering is repeated, the allowed time is the accumulated time.

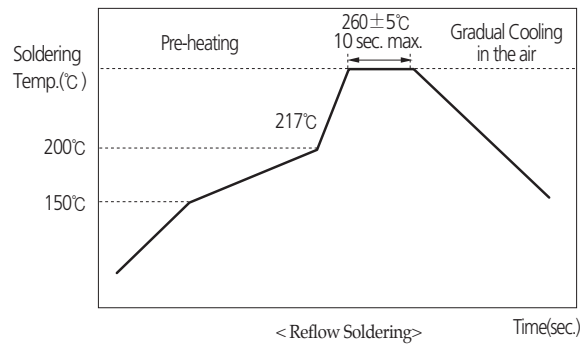

• Standard solder amount

When a PCB is warped, mechanical stress applied to the chip should be reduced, and to do so, care should be taken not to use excessive amount of solder on the PCB. In the case of the reflow method, the thickness of the coated solder paste is controlled to prevent excessive solder. The thickness of solder paste should be 100~300µm.

• Tombstoning and Prevention

When reflow soldering, or especially vapor phase soldering (VPS), small chip components of less than RC3216 type may break away from solder and stand on end. This is commonly known as tombstoning or the Manhattan phenomenon.

- Preventing tombstoning

Keep land size as small as possible.

Keep the pre-heating conditions properly

(Pre-heating temperature : 150 ~ 180°, Pre-heating time : more than 1 min.)

Keep the solder paste quantity not too much and uniform for every lands.

Keep the position of chips properly.

At around the soldering temperature, keep minimum difference of the temperature between the electrodes of a chip.

Iron Soldering

When using a soldering iron or any other soldering operation, the permissible temperature and time should not exceed that of the reflow soldering. In order to prevent the external terminations from leaching and characteristics from deteriorating, the tip of the soldering iron should not touch the chip component (ceramic element, resin case, etc.). Soldering with a soldering iron and correcting with a soldering iron can be performed right under following conditions.

| Item | Condition |
|-----------------------|--|
| Temperature at tip | 350°C Max. |
| Soldering iron output | 20-Watt Max. |
| End of soldering iron | ∅ 3mm Max. |
| Note | Do not directly touch the chip by the tip of the iron. |

General Structure of the Chip Resistor

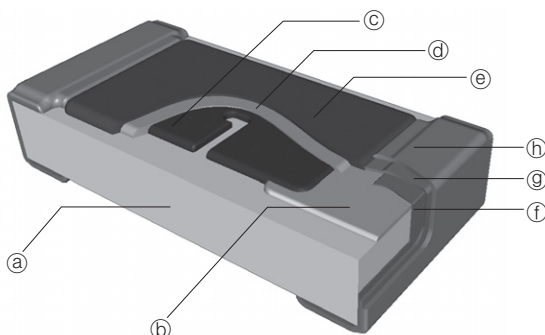

| No. | Name | Main Substance |
|-----|-------------------|---|
| (a) | Ceramic Substrate | Al ₂ O ₃ |
| (b) | Inner Electrode | Ag |
| (c) | Resistor | RuO ₂ |
| (d) | Glass Coat | Bi ₂ O ₃ , SiO ₂ |
| (e) | Protective Coat | Polymer / Glass |
| (f) | Terminal Coat | Ni-Cr Alloy /Ag |
| (g) | Ni Plate | Ni |
| (h) | Sn Plate | Sn |

Operation Notes

Example of land Pattern Design

Recommended Soldering Conditions

General Structure

General

Low ohms (RUT Series)

Ultra Low ohms (RU Series)

Ultra Low Ohms (RUK Series)

Ultra Low Ohms (RJ Series)

Arrays (CONVEX Type)

Arrays (CONCAVE Type)

Arrays (FLAT Type)

Anti-Sulfur Resistors

Anti-Sulfur Resistor Arrays(Convex Type)

Anti-Sulfur Resistor Arrays(Concave Type)

Anti-Sulfur Resistor Arrays (Flat Type)

Automotive Anti-sulfur

Automotive Anti-sulfur Arrays (Convex Type)

Attenuator

Characteristics Performance

Packaging

Standard Resistance Value

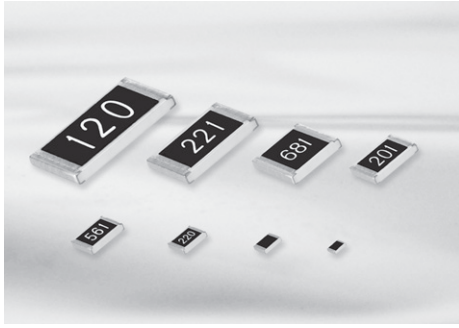

Feature

- Very small, thin, and light weight.
- Both flow and reflow soldering are applicable.
- Very low inductance.
- Suitable size and packaging for surface mount assembly.
- Lead-free terminal.
- PbO(lead oxide) is included in the glass of our product which is prescribed on RoHS appendix as an exemption.

Application

- General purpose.
- Home Appliances.
(DVD, Digital TV, Digital Camera, Audio, Tunner).
- For Computers & Communications.
(Notebook, Memory Module, Mobile, Network Equipment, etc).

Structure and Dimensions

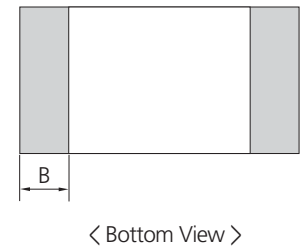
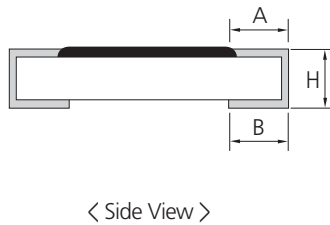
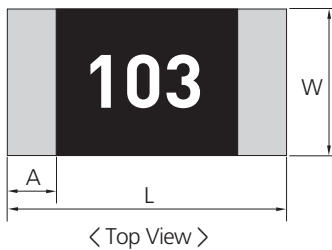

(UNIT: mm)

| Type | SIZE(Inch) | L | W | H | A | B |
|--------|------------|------------|------------|------------|------------|------------|
| RC0402 | 01005 | 0.40 ±0.02 | 0.20 ±0.02 | 0.13 ±0.02 | 0.10 ±0.03 | 0.10 ±0.03 |
| RC0603 | 0201 | 0.60 ±0.03 | 0.30 ±0.03 | 0.23 ±0.03 | 0.10 ±0.05 | 0.15 ±0.05 |
| RC1005 | 0402 | 1.00 ±0.05 | 0.50 ±0.05 | 0.35 ±0.05 | 0.20 ±0.10 | 0.25 ±0.10 |
| RC1608 | 0603 | 1.60 ±0.10 | 0.80 ±0.10 | 0.45 ±0.10 | 0.30 ±0.20 | 0.30 ±0.10 |
| RC2012 | 0805 | 2.00 ±0.15 | 1.25 ±0.15 | 0.50 ±0.10 | 0.40 ±0.20 | 0.35 ±0.20 |
| RC3216 | 1206 | 3.20 ±0.15 | 1.60 ±0.15 | 0.55 ±0.10 | 0.45 ±0.20 | 0.40 ±0.20 |
| RC3225 | 1210 | 3.20 ±0.20 | 2.55 ±0.20 | 0.55 ±0.10 | 0.45 ±0.20 | 0.40 ±0.20 |
| RC5025 | 2010 | 5.00 ±0.20 | 2.50 ±0.20 | 0.55 ±0.10 | 0.60 ±0.20 | 0.60 ±0.20 |
| RC6432 | 2512 | 6.30 ±0.20 | 3.20 ±0.20 | 0.55 ±0.10 | 0.60 ±0.20 | 0.60 ±0.20 |

- ※ 0402 and smaller size don't have marking on top of the chips.
- ※ 0603 4-digit models(E-96 series) don't have making on top of the chips.

Parts Numbering System

- The part number system shall be in the following format

| RC | 2012 Dimension & Size Code | J Tolerance | 100 Resistance Value | CS Packaging Code |
|-------------------|---|--|--|---|
| RC: Chip Resistor | 0402: 0.4×0.2(mm) - 01005(inch) 0603: 0.6×0.3(mm) - 0201(inch) 1005: 1.0×0.5(mm) - 0402(inch) 1608: 1.6×0.8(mm) - 0603(inch) 2012: 2.0×1.2(mm) - 0805(inch) 3216: 3.2×1.6(mm) - 1206(inch) 3225: 3.2×2.5(mm) - 1210(inch) 5025: 5.0×2.5(mm) - 2010(inch) 6432: 6.4×3.2(mm) - 2512(inch) | D : ±0.5% F : ±1% G : ±2% J : ±5% ※ Jumper : J | 3 or 4 digits coding system (EIA coding system) 3digits (E-24 series) 4digits (E-96 series) ※ Jumper : '000' | CS: Tape Packaging 7" ES: Tape Packaging 10" AS: Tape Packaging 13" |

Specification

| Type | Size (inch) | Rated Power (W) | Rated Voltage (V) | Max Working Voltage (V) | Tolerance (%) | Resistance Range (Ω) | T.C.R (ppm/°C) | Working Temp. (°C) | Rated Ambient Temp. (°C) | Moisture Level |
|---------|-------------|-----------------|--|-------------------------|------------------------------------|----------------------|----------------|--------------------|--------------------------|----------------|
| RC 0402 | 01005 | 1/32 | $\sqrt{P \times R}$ P: Rated Power(W) R: Resistance(Ω) | 15 | ±1(F) ±2(G) ±5(J) | 1 ~ 99 100 ~ 1M | ±300 ±250 | -55~125 | 70 | Level 1 |
| RC 0603 | 0201 | 1/20 | | 25 | | 1 ~ 9.9 10 ~ 10M | | | | |
| RC 1005 | 0402 | 1/16 | | 50 | ±0.5(D) ±1(F) ±2(G) ±5(J) | 1 ~ 9.9 10 ~ 10M | ±300 ±100 | -55~155 | | |
| RC 1608 | 0603 | 1/10 | | 50 | | | | | | |
| RC 2012 | 0805 | 1/8 | | 150 | | | | | | |
| RC 3216 | 1206 | 1/4 | | 200 | | | | | | |
| RC 3225 | 1210 | 1/3 | | 200 | | | | | | |
| RC 5025 | 2010 | 2/3 | | 200 | | | | | | |
| RC 6432 | 2512 | 1 | 200 | | | | | | | |

• Please contact our sales representatives or engineers for other specifications

Power Derating Curve

The rated power is the maximum continuous loading power at 70°C ambient temperature.
For ambient temperature above 70°C, the loading power follows the below power derating curve.

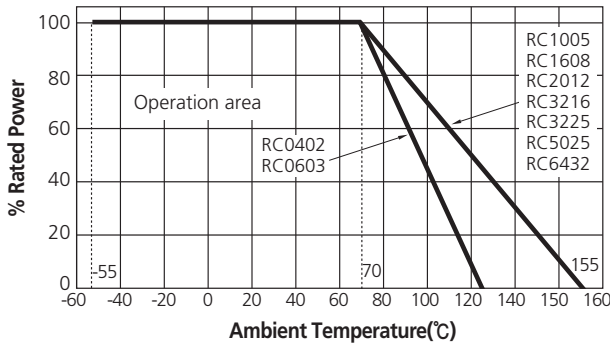

Marking

| • 3 digits indication (E-24 series) | • 4 digits indication (E-96 series) |
|---|---|
| - Left 2 digits represent significant figures. - Last 1 digit represents exponential number of 10. - Example: 103 Left 2 digits: 10 Last 1 digit: 3 $103 = 10 \times 10^3 \Omega$ $= 10000 \Omega = 10k\Omega$ | - Left 3 digits represent significant figures. - Last 1 digit represents exponential number of 10. - Example: 1002 Left 3 digits: 100 Last 1 digit: 2 $1002 = 100 \times 10^2 \Omega$ $= 10000 \Omega = 10k\Omega$ |
| | |
| No marking types : RC0402, RC0603, RC1005 | No marking types : RC0402, RC0603, RC1005, RC1608 |

Jumper Rating

| Type | Size (inch) | Rated Current (A) | Resistance (Ω) |
|--------|-------------|-------------------|----------------|
| RC0402 | 01005 | 0.5 | 0.05 Max |
| RC0603 | 0201 | | |
| RC1005 | 0402 | 1.0 | |
| RC1608 | 0603 | | |
| RC2012 | 0805 | 2.0 | |
| RC3216 | 1206 | | |
| RC3225 | 1210 | | |
| RC5025 | 2010 | | |
| RC6432 | 2512 | | |

IEC Code System (E-96, E-24)

| E-96 | E-24 | E-96 | E-24 | E-96 | E-24 | E-96 | E-24 |
|------|------|------|------|------|------|------|------|
| 100 | 10 | 178 | | 316 | | 562 | 56 |
| 102 | | 182 | 18 | 324 | 33 | 576 | |
| 105 | | 187 | | 332 | | 590 | |
| 107 | | 191 | | 340 | | 604 | |
| 110 | 11 | 196 | | 348 | | 619 | |
| 113 | | 200 | 20 | 357 | 36 | 634 | 62 |
| 115 | | 205 | | 365 | | 649 | |
| 118 | | 210 | | 374 | | 665 | |
| 121 | 12 | 215 | | 383 | 39 | 681 | 68 |
| 124 | | 221 | 22 | 392 | | 698 | |
| 127 | | 226 | | 402 | | 715 | |
| 130 | 13 | 232 | | 412 | | 732 | |
| 133 | | 237 | | 422 | | 750 | 75 |
| 137 | | 243 | 24 | 432 | 43 | 768 | |
| 140 | | 249 | | 442 | | 787 | |
| 143 | | 255 | | 453 | | 806 | |
| 147 | | 261 | | 464 | | 825 | 82 |
| 150 | 15 | 267 | | 475 | 47 | 845 | |
| 154 | | 274 | 27 | 487 | | 866 | |
| 158 | | 280 | | 499 | | 887 | |
| 162 | 16 | 287 | | 511 | 51 | 909 | |
| 165 | | 294 | | 523 | | 931 | 91 |
| 169 | | 301 | 30 | 536 | | 953 | |
| 174 | | 309 | | 549 | | 976 | |

The specifications and designs contained herein may be subject to change without notice.
Please contact our sales representatives or product engineers before order.

- Operation Notes
- Example of land Pattern Design
- Recommended Soldering Conditions
- General Structure
- General
- Low ohms (RUT Series)
- Ultra Low ohms (RU Series)
- Ultra Low Ohms (RUK Series)
- Ultra Low Ohms (RJ Series)
- Arrays (CONVEX Type)
- Arrays (CONCAVE Type)
- Arrays (FLAT Type)
- Anti-Sulfur Resistors
- Anti-Sulfur Resistor Arrays(Convex Type)
- Anti-Sulfur Resistor Arrays(Concave Type)
- Anti-Sulfur Resistor Arrays (Flat Type)
- Automotive Anti-sulfur
- Automotive Anti-sulfur Arrays (Convex Type)
- Attenuator
- Characteristics Performance
- Packaging
- Standard Resistance Value

Low Ohms(RUT Series)

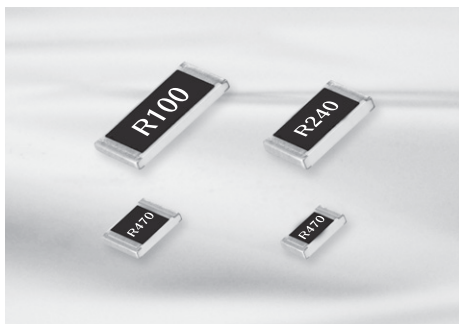

Feature

- Under 1 ohms, precision resistance.
- Both flow and reflow soldering are applicable.
- High Power with Low TCR.
- 100% Lead Free Products (PbO not used).
- RoHS Compliant.

Application

- Current Sensing.
- PCM of Battery Pack.
- Power supplying part, DC power charger, adapter.
- Mobile Phone, HDD, DSC, LCD.

Structure and Dimensions

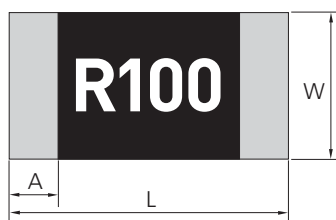

< Top View >

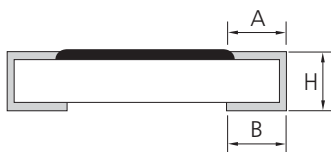

< Side View >

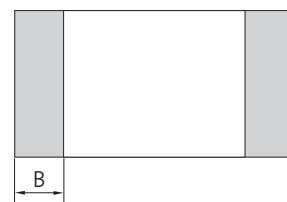

< Bottom View >

(UNIT: mm)

| Type | SIZE(Inch) | L | W | H | A | B |
|---------|------------|-----------|-----------|-----------|-----------|-----------|
| RUT1005 | 0402 | 1.00±0.05 | 0.50±0.05 | 0.35±0.05 | 0.20±0.10 | 0.25±0.10 |
| RUT1608 | 0603 | 1.60±0.10 | 0.80±0.10 | 0.45±0.10 | 0.30±0.20 | 0.30±0.10 |
| RUT2012 | 0805 | 2.00±0.15 | 1.25±0.15 | 0.50±0.10 | 0.40±0.20 | 0.35±0.20 |
| RUT3216 | 1206 | 3.20±0.15 | 1.60±0.15 | 0.55±0.10 | 0.45±0.20 | 0.40±0.20 |
| RUT3225 | 1210 | 3.20±0.20 | 2.55±0.20 | 0.55±0.10 | 0.45±0.20 | 0.40±0.20 |
| RUT5025 | 2010 | 5.00±0.20 | 2.50±0.20 | 0.55±0.10 | 0.60±0.20 | 0.60±0.20 |
| RUT6432 | 2512 | 6.30±0.20 | 3.20±0.20 | 0.55±0.10 | 0.60±0.20 | 0.60±0.20 |

Parts Numbering System

- The part number system shall be in the following format

| RUT Code Designation | 2012 Dimension & Size Code | J Tolerance | R100 Resistance Value | CS Packaging Code |
|--|--|----------------------------|--------------------------|--|
| RUT: Current Sensing Resistor Top Mounting (Face-up) | 1005: 1.0×0.5(mm) - 0402(inch) 1608: 1.6×0.8(mm) - 0603(inch) 2012: 2.0×1.2(mm) - 0805(inch) 3216: 3.2×1.6(mm) - 1206(inch) 3225: 3.2×2.5(mm) - 1210(inch) 5025: 5.0×2.5(mm) - 2010(inch) 6432: 6.4×3.2(mm) - 2512(inch) | F: ±1% G: ±2% J: ±5% | 4-digit coding system | CS: Tape & Reel 7" ES: Tape & Reel 10" AS: Tape & Reel 13" |

Specification

| Type | Size (inch) | Rated Power (W) | Resistance (Ω) | T.C.R (ppm/°C) | Rated Current (A) | Rated Ambient Temperature (°C) | Working Temperature (°C) |
|---------|-------------|-----------------|----------------|----------------|---|--------------------------------|--------------------------|
| RUT1005 | 0402 | 1/10 | 0.1~0.976 | ±150 | $\sqrt{P/R}$ P: Rated Power(W) R: Resistance(Ω) | 70 | -55~+155 |
| RUT1608 | 0603 | 1/8 | | | | | |
| RUT2012 | 0805 | 1/4 | | | | | |
| RUT3216 | 1206 | 1/3 | | | | | |
| RUT3225 | 1210 | 1/2 | | | | | |
| RUT5025 | 2010 | 2/3 | | | | | |
| RUT6432 | 2512 | 1 | | | | | |

• Please contact our sales representatives or engineers for other specifications

Power Derating Curve

The rated power is the maximum continuous loading power at 70°C ambient temperature.
For ambient temperature above 70°C, the loading power follows the below power derating curve.

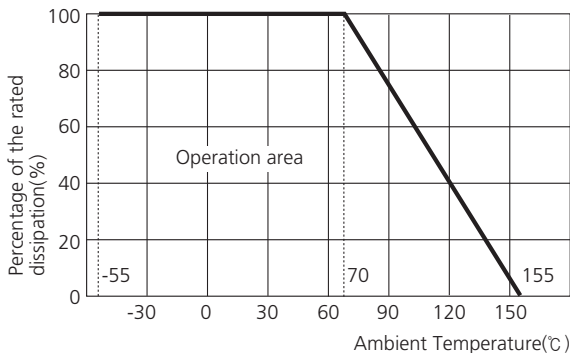

Marking

4 digits indication

- R means decimal point.
- Other digits represent the significant value.
- Example : R100
 $R100 = .100 = 0.100\Omega$
 $= 0.1\Omega$ or $100M\Omega$



Resistance Value Table

| Code | Value (Ω) | Tol (%) | Code | Value (Ω) | Tol (%) | Code | Value (Ω) | Tol (%) | Code | Value (Ω) | Tol (%) | Code | Value (Ω) | Tol (%) | Code | Value (Ω) | Tol (%) |
|------|-----------|---------|------|-----------|---------|------|-----------|---------|------|-----------|---------|------|-----------|---------|------|-----------|---------|
| R100 | 0.1 | ±1,±5 | R154 | 0.154 | ±1 | R226 | 0.226 | ±1 | R330 | 0.33 | ±1,±5 | R470 | 0.47 | ±1,±5 | R680 | 0.68 | ±1,±5 |
| R102 | 0.102 | ±1 | R158 | 0.158 | ±1 | R232 | 0.232 | ±1 | R332 | 0.332 | ±1 | R475 | 0.475 | ±1 | R681 | 0.681 | ±1 |
| R105 | 0.105 | ±1 | R160 | 0.16 | ±1,±5 | R237 | 0.237 | ±1 | R340 | 0.34 | ±1 | R487 | 0.487 | ±1 | R698 | 0.698 | ±1 |
| R107 | 0.107 | ±1 | R162 | 0.162 | ±1 | R240 | 0.24 | ±1,±5 | R348 | 0.348 | ±1 | R499 | 0.499 | ±1 | R715 | 0.715 | ±1 |
| R110 | 0.11 | ±1,±5 | R165 | 0.165 | ±1 | R243 | 0.243 | ±1 | R357 | 0.357 | ±1 | R510 | 0.51 | ±1,±5 | R732 | 0.732 | ±1 |
| R113 | 0.113 | ±1 | R169 | 0.169 | ±1 | R249 | 0.249 | ±1 | R360 | 0.36 | ±1,±5 | R511 | 0.511 | ±1 | R750 | 0.75 | ±1,±5 |
| R115 | 0.115 | ±1 | R174 | 0.174 | ±1 | R255 | 0.255 | ±1 | R365 | 0.365 | ±1 | R523 | 0.523 | ±1 | R768 | 0.768 | ±1 |
| R118 | 0.118 | ±1 | R178 | 0.178 | ±1 | R261 | 0.261 | ±1 | R374 | 0.374 | ±1 | R536 | 0.536 | ±1 | R787 | 0.787 | ±1 |
| R120 | 0.12 | ±1,±5 | R180 | 0.180 | ±1,±5 | R267 | 0.267 | ±1 | R383 | 0.383 | ±1 | R549 | 0.549 | ±1 | R806 | 0.806 | ±1 |
| R121 | 0.121 | ±1 | R182 | 0.182 | ±1 | R270 | 0.27 | ±1,±5 | R390 | 0.39 | ±1,±5 | R560 | 0.56 | ±1,±5 | R820 | 0.82 | ±1,±5 |
| R124 | 0.124 | ±1 | R187 | 0.187 | ±1 | R274 | 0.274 | ±1 | R392 | 0.392 | ±1 | R562 | 0.562 | ±1 | R825 | 0.825 | ±1 |
| R127 | 0.127 | ±1 | R191 | 0.191 | ±1 | R280 | 0.28 | ±1 | R402 | 0.402 | ±1 | R576 | 0.576 | ±1 | R845 | 0.845 | ±1 |
| R130 | 0.13 | ±1,±5 | R196 | 0.196 | ±1 | R287 | 0.287 | ±1 | R412 | 0.412 | ±1 | R590 | 0.59 | ±1 | R866 | 0.866 | ±1 |
| R133 | 0.133 | ±1 | R200 | 0.200 | ±1,±5 | R294 | 0.294 | ±1 | R422 | 0.422 | ±1 | R604 | 0.604 | ±1 | R887 | 0.887 | ±1 |
| R137 | 0.137 | ±1 | R205 | 0.205 | ±1 | R300 | 0.3 | ±1,±5 | R430 | 0.43 | ±1,±5 | R619 | 0.619 | ±1 | R909 | 0.909 | ±1 |
| R140 | 0.14 | ±1 | R210 | 0.21 | ±1 | R301 | 0.301 | ±1 | R432 | 0.432 | ±1 | R620 | 0.62 | ±1,±5 | R910 | 0.91 | ±1,±5 |
| R143 | 0.143 | ±1 | R215 | 0.215 | ±1 | R309 | 0.309 | ±1 | R442 | 0.442 | ±1 | R634 | 0.634 | ±1 | R931 | 0.931 | ±1 |
| R147 | 0.147 | ±1 | R220 | 0.22 | ±1,±5 | R316 | 0.316 | ±1 | R453 | 0.453 | ±1 | R649 | 0.649 | ±1 | R953 | 0.953 | ±1 |
| R150 | 0.15 | ±1,±5 | R221 | 0.221 | ±1 | R324 | 0.324 | ±1 | R464 | 0.464 | ±1 | R665 | 0.665 | ±1 | R976 | 0.976 | ±1 |

The specifications and designs contained herein may be subject to change without notice.
Please contact our sales representatives or product engineers before order.

Operation Notes

Example of land Pattern Design

Recommended Soldering Conditions

General Structure

General

Low ohms (RUT Series)

Ultra Low ohms (RU Series)

Ultra Low Ohms (RUK Series)

Ultra Low Ohms (RJ Series)

Arrays (CONVEX Type)

Arrays (CONCAVE Type)

Arrays (FLAT Type)

Anti-Sulfur Resistors

Anti-Sulfur Resistor Arrays(Convex Type)

Anti-Sulfur Resistor Arrays(Concave Type)

Anti-Sulfur Resistor Arrays (Flat Type)

Automotive Anti-sulfur

Automotive Anti-sulfur Arrays (Convex Type)

Attenuator

Characteristics Performance

Packaging

Standard Resistance Value

Ultra Low Ohms(RU Series)

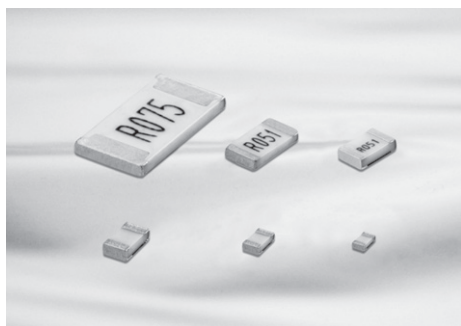

Feature

- Thick Film Type Ultra Low Ohm Resistor.
- High Precision Reliability.
- High Power with Low TCR.
- 100% Lead Free Products (PbO not used).
- RoHS Compliant.

Application

- Current Sensing.
- PCM of Battery Pack.
- Power supplying part, DC power charger, adapter.
- Mobile Phone, Mobile PC, Note PC, HDD, DSC, LCD.

Structure and Dimensions

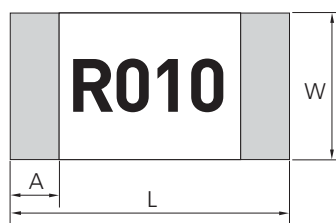

< Top View >

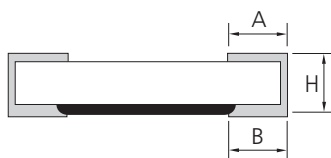

< Side View >



< Bottom View >

(UNIT: mm)

| Type | SIZE(Inch) | L | W | H | A | B |
|--------|------------|-----------|-----------|-----------|-----------|--|
| RU1005 | 0402 | 1.00±0.05 | 0.50±0.05 | 0.35±0.05 | 0.25±0.15 | 0.25±0.15 |
| RU1608 | 0603 | 1.60±0.10 | 0.80±0.10 | 0.45±0.10 | 0.30±0.20 | R ≤ 0.05 : 0.50 ± 0.20 R > 0.05 : 0.35 ± 0.20 |
| RU2012 | 0805 | 2.00±0.15 | 1.25±0.15 | 0.55±0.10 | 0.40±0.20 | R ≤ 0.05 : 0.65 ± 0.20 R > 0.05 : 0.40 ± 0.20 |
| RU3216 | 1206 | 3.20±0.15 | 1.60±0.15 | 0.60±0.10 | 0.45±0.20 | R ≤ 0.05 : 0.90 ± 0.20 R > 0.05 : 0.60 ± 0.20 |
| RU3225 | 1210 | 3.20±0.20 | 2.55±0.20 | 0.55±0.10 | 0.45±0.20 | R ≤ 0.05 : 1.20 ± 0.20 R > 0.05 : 0.75 ± 0.20 |
| RU5025 | 2010 | 5.00±0.20 | 2.50±0.20 | 0.60±0.10 | 0.50±0.20 | R ≤ 0.05 : 1.50 ± 0.20 R > 0.05 : 0.90 ± 0.20 |
| RU6432 | 2512 | 6.30±0.20 | 3.20±0.20 | 0.60±0.10 | 0.50±0.20 | R ≤ 0.05 : 1.90 ± 0.20 R > 0.05 : 1.10 ± 0.25 |

Parts Numbering System

- The part number system shall be in the following format

| RU | 2012 | F | R051 | CS |
|-------------------------------|--------------------------------|----------------------------|-----------------------|---------------------|
| Code Designation | Dimension & Size Code | Tolerance | Resistance Value | Packaging Code |
| RU : Current sensing resistor | 1005: 1.0×0.5(mm) - 0402(inch) | F: ±1% G: ±2% J: ±5% | 4-digit coding system | CS: Tape & Reel 7" |
| | 1608: 1.6×0.8(mm) - 0603(inch) | | | ES: Tape & Reel 10" |
| | 2012: 2.0×1.2(mm) - 0805(inch) | | | AS: Tape & Reel 13" |
| | 3216: 3.2×1.6(mm) - 1206(inch) | | | |
| | 3225: 3.2×2.5(mm) - 1210(inch) | | | |
| | 5025: 5.0×2.5(mm) - 2010(inch) | | | |
| | 6432: 6.4×3.2(mm) - 2512(inch) | | | |

Specification

| Type | Size (inch) | Rated Power (W) | Resistance (Ω) | T.C.R (ppm/°C) | Rated Current (A) | Rated Ambient Temperature (°C) | Working Temperature (°C) |
|--------|-------------|-----------------|----------------|--|---|--------------------------------|--------------------------|
| RU1005 | 0402 | 1/8 | 0.02~0.1 | R<0.047: ± 500 R≥0.047: ± 150 | $\sqrt{P/R}$ P: Rated Power(W) R: Resistance(Ω) | 70 | -55 ~ +155 |
| RU1608 | 0603 | 1/4 | 0.01~0.1 | R≤0.025: ± 600 R<0.033: ± 400 R≥0.033: ± 150 | | | |
| RU2012 | 0805 | 1/3 | | | | | |
| RU3216 | 1206 | 1/2 | 0.01~0.1 | R≤0.025: ± 500 R<0.033: ± 350 R≥0.033: ± 150 | | | |
| RU3225 | 1210 | 2/3 | | | | | |
| RU5025 | 2010 | 3/4 | | | | | |
| RU6432 | 2512 | 1 | | | | | |

• Please contact our sales representatives or engineers for other specifications

Power Derating Curve

The rated power is the maximum continuous loading power at 70°C ambient temperature. For ambient temperature above 70°C, the loading power follows the below power derating curve.

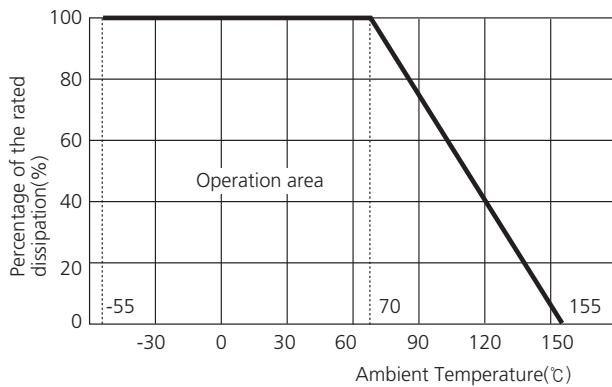

Marking

4-digit Coding System

- R means decimal point.
- Other digits represent the significant value.
- Example : R010
R010 = .010 = 0.010Ω
= 0.01Ω or 10MΩ



Resistance Value Table

| Code | Value (Ω) | Tol (%) | Code | Value (Ω) | Tol (%) | Code | Value (Ω) | Tol (%) | Code | Value (Ω) | Tol (%) |
|------|-----------|---------|------|-----------|---------|------|-----------|---------|------|-----------|---------|
| R010 | 0.010 | ±1, ±5 | R020 | 0.020 | ±1, ±5 | R039 | 0.039 | ±1, ±5 | R062 | 0.062 | ±1, ±5 |
| R011 | 0.011 | ±1, ±5 | R022 | 0.022 | ±1, ±5 | R040 | 0.040 | ±1, ±5 | R068 | 0.068 | ±1, ±5 |
| R012 | 0.012 | ±1, ±5 | R024 | 0.024 | ±1, ±5 | R043 | 0.043 | ±1, ±5 | R075 | 0.075 | ±1, ±5 |
| R013 | 0.013 | ±1, ±5 | R027 | 0.027 | ±1, ±5 | R047 | 0.047 | ±1, ±5 | R082 | 0.082 | ±1, ±5 |
| R015 | 0.015 | ±1, ±5 | R030 | 0.030 | ±1, ±5 | R050 | 0.050 | ±1, ±5 | R091 | 0.091 | ±1, ±5 |
| R016 | 0.016 | ±1, ±5 | R033 | 0.033 | ±1, ±5 | R051 | 0.051 | ±1, ±5 | R100 | 0.100 | ±1, ±5 |
| R018 | 0.018 | ±1, ±5 | R036 | 0.036 | ±1, ±5 | R056 | 0.056 | ±1, ±5 | | | |

The specifications and designs contained herein may be subject to change without notice. Please contact our sales representatives or product engineers before order.

Operation Notes

Example of land Pattern Design

Recommended Soldering Conditions

General Structure

General

Low ohms (RUT Series)

Ultra Low ohms (RU Series)

Ultra Low Ohms (RUK Series)

Ultra Low Ohms (RJ Series)

Arrays (CONVEX Type)

Arrays (CONCAVE Type)

Arrays (FLAT Type)

Anti-Sulfur Resistors

Anti-Sulfur Resistor Arrays(Convex Type)

Anti-Sulfur Resistor Arrays(Concave Type)

Anti-Sulfur Resistor Arrays (Flat Type)

Automotive Anti-sulfur

Automotive Anti-sulfur Arrays (Convex Type)

Attenuator

Characteristics Performance

Packaging

Standard Resistance Value

Ultra Low Ohms(RUK Series)

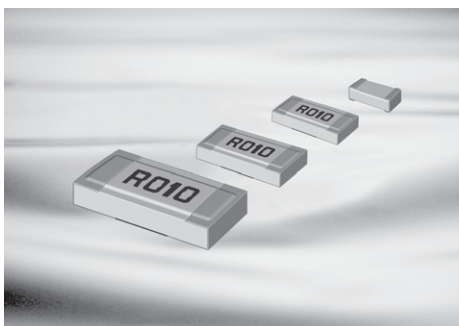

Feature

- Thick Film Type Ultra Low Ohm Resistor.
- High Precision Reliability.
- High Power with Very Low TCR.
- 100% Lead Free Products (PbO not used).
- RoHS Compliant.

Application

- Current Sensing.
- PCM of Battery Pack.
- Power supplying part, DC power charger, adapter.
- Mobile Phone, Mobile PC, Note PC, HDD, DSC, LCD.

Structure and Dimensions

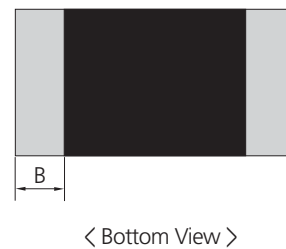
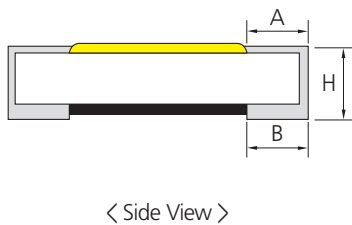
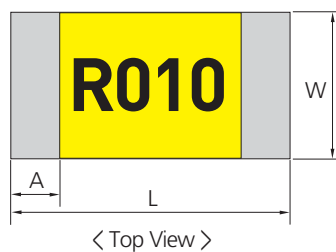

(UNIT: mm)

| Type | SIZE(Inch) | L | W | H | A | B |
|---------|------------|-----------|-----------|-----------|-----------|-----------|
| RUK1608 | 0603 | 1.60±0.10 | 0.80±0.10 | 0.45±0.10 | 0.35±0.20 | 0.50±0.20 |
| RUK2012 | 0805 | 2.00±0.15 | 1.25±0.15 | 0.55±0.10 | 0.40±0.20 | 0.55±0.20 |
| RUK3216 | 1206 | 3.20±0.15 | 1.60±0.15 | 0.65±0.10 | 0.45±0.20 | 0.90±0.20 |
| RUK6432 | 2512 | 6.30±0.20 | 3.20±0.20 | 0.65±0.10 | 1.15±0.20 | 0.90±0.20 |

Parts Numbering System

- The part number system shall be in the following format

| RUK | 1608 | F | R010 | CS |
|---|--------------------------------|----------------------------|------------------------|---------------------|
| Code Designation | Dimension & Size Code | Tolerance | Resistance Value | Packaging Code |
| RUK : Current Sensing Resistor Low TCR | 1608: 1.6×0.8(mm) - 0603(inch) | F: ±1% G: ±2% J: ±5% | 4-digits coding system | CS: Tape & Reel 7" |
| | 2012: 2.0×1.2(mm) - 0805(inch) | | | ES: Tape & Reel 10" |
| | 3216: 3.2×1.6(mm) - 1206(inch) | | | AS: Tape & Reel 13" |
| | 3225: 3.2×2.5(mm) - 1210(inch) | | | |
| | 5025: 5.0×2.5(mm) - 2010(inch) | | | |
| 6432: 6.4×3.2(mm) - 2512(inch) | | | | |

Specification

| Type | Size (inch) | Rated Power (W) | Resistance (Ω) | T.C.R (ppm/°C) | Rated Current (A) | Rated Ambient Temperature (°C) | Working Temperature (°C) |
|---------|-------------|-----------------|----------------|----------------|--|--------------------------------|--------------------------|
| RUK1608 | 0603 | 1/2 | 0.01 ~ 0.03 | ± 100 | $\sqrt{P/R}$ P: Rated Power(W) R: Resistance (Ω) | 70 | -55 ~ +155 |
| RUK2012 | 0805 | 1/2 | | | | | |
| RUK3216 | 1206 | 1 | | | | | |
| RUK6432 | 2512 | 1 | | | | | |

• Please contact our sales representatives or engineers for other specifications

Power Derating Curve

The rated power is the maximum continuous loading power at 70°C ambient temperature. For ambient temperature above 70°C, the loading power follows the below power derating curve.

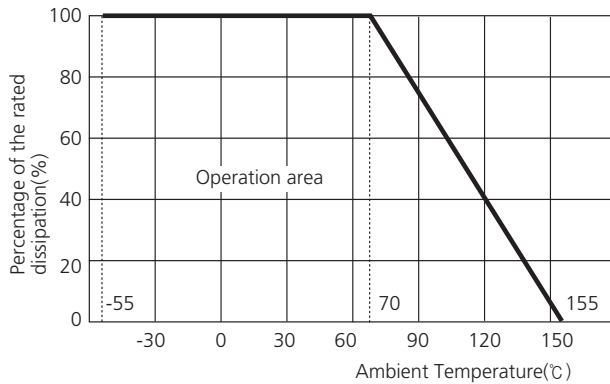

Marking

4-digits coding system

- R means decimal point.
- Other digits represent significant value.
- Example : R010
R010 = .010 = 0.010Ω
= 0.01Ω or 10mΩ



Resistance Value Table

| Code | Value(Ω) | Tol(%) | Code | Value(Ω) | Tol(%) |
|------|----------|--------|------|----------|--------|
| R010 | 0.010 | ±1, ±5 | R018 | 0.018 | ±1, ±5 |
| R011 | 0.011 | ±1, ±5 | R020 | 0.020 | ±1, ±5 |
| R012 | 0.012 | ±1, ±5 | R022 | 0.022 | ±1, ±5 |
| R013 | 0.013 | ±1, ±5 | R024 | 0.024 | ±1, ±5 |
| R015 | 0.015 | ±1, ±5 | R027 | 0.027 | ±1, ±5 |
| R016 | 0.016 | ±1, ±5 | R030 | 0.030 | ±1, ±5 |

The specifications and designs contained herein may be subject to change without notice. Please contact our sales representatives or product engineers before order.

Operation Notes

Example of land Pattern Design

Recommended Soldering Conditions

General Structure

General

Low ohms (RUT Series)

Ultra Low ohms (RU Series)

Ultra Low Ohms (RUK Series)

Ultra Low Ohms (RJ Series)

Arrays (CONVEX Type)

Arrays (CONCAVE Type)

Arrays (FLAT Type)

Anti-Sulfur Resistors

Anti-Sulfur Resistor Arrays(Convex Type)

Anti-Sulfur Resistor Arrays(Concave Type)

Anti-Sulfur Resistor Arrays (Flat Type)

Automotive Anti-sulfur

Automotive Anti-sulfur Arrays (Convex Type)

Attenuator

Characteristics Performance

Packaging

Standard Resistance Value

Ultra Low Ohms(RJ Series)

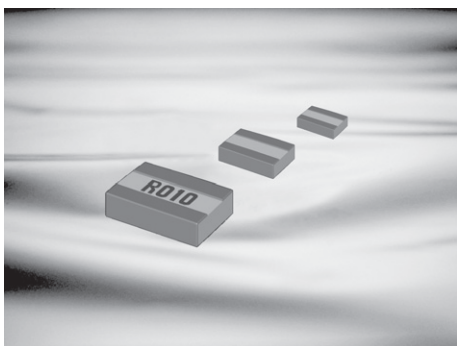

Feature

- Thick Film Wide Terminal Type.
- High Precision Reliability.
- High Power with Low TCR.
- 100% Lead Free Products (PbO not used).
- RoHS Compliant.

Application

- Current Sensing.
- PCM of Battery Pack.
- DC Power Charger, Adapter.
- Mobile Phone, Mobile PC, HDD, DSC, LCD.

Structure and Dimensions

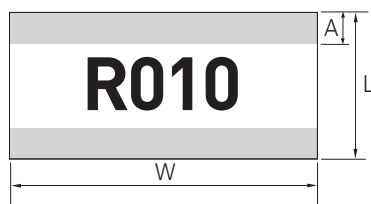

< Top View >

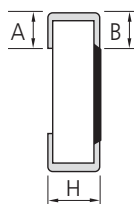

< Side View >



< Bottom View >

(UNIT: mm)

| Type | SIZE(Inch) | L | W | H | A | B |
|--------|------------|-----------|-----------|-----------|-----------|-----------|
| RJ0816 | 0306 | 0.80±0.10 | 1.60±0.10 | 0.45±0.15 | 0.25±0.15 | 0.30±0.15 |
| RJ1220 | 0508 | 1.25±0.10 | 2.00±0.10 | 0.55±0.15 | 0.30±0.15 | 0.35±0.15 |
| RJ1632 | 0612 | 1.60±0.15 | 3.20±0.15 | 0.55±0.15 | 0.35±0.20 | 0.40±0.20 |
| RJ2037 | 0815 | 2.00±0.15 | 3.75±0.15 | 0.55±0.15 | 0.45±0.20 | 0.55±0.20 |
| RJ3264 | 1225 | 3.20±0.20 | 6.40±0.20 | 0.55±0.15 | 0.60±0.20 | 0.60±0.20 |

Parts Numbering System

- The part number system shall be in the following format

| RJ | 0816 | F | R010 | CS |
|------------------|-----------------------|-----------|------------------|----------------|
| Code Designation | Dimension & Size Code | Tolerance | Resistance Value | Packaging Code |

| | | | | |
|---|---------------------------------|----------------------------|------------------------|---------------------|
| RJ : Thick Film Wide Terminal CSR | 0816 : 0.8×1.6(mm) - 0306(inch) | F: ±1% G: ±2% J: ±5% | 4-digits coding system | CS: Tape & Reel 7" |
| | 1220 : 1.2×2.0(mm) - 0508(inch) | | | ES: Tape & Reel 10" |
| | 1632 : 1.6×3.2(mm) - 0612(inch) | | | AS: Tape & Reel 13" |
| | 2037 : 2.0×3.7(mm) - 0815(inch) | | | |
| | 3264 : 3.2×6.4(mm) - 1225(inch) | | | |

Specification

| Type | Size (inch) | Rated Power (W) | Resistance (Ω) | T.C.R (ppm/°C) | Rated Current (A) | Rated Ambient Temperature (°C) | Working Temperature (°C) |
|-----------------------|-------------|-----------------|----------------|----------------|---|--------------------------------|--------------------------|
| RJ0816 ⁽¹⁾ | 0306 | 1/2 | 0.005 ~ 0.02 | ± 100 | $\sqrt{P/R}$ P: Rated Power(W) R: Resistance(Ω) | 70 | -55 ~ +155 |
| RJ1220 | 0508 | 1 | 0.005 ~ 0.02 | -200 ~ 0 | | | |
| | | 1/2 | 0.021 ~ 0.05 | -200 ~ 0 | | | |
| RJ1632 | 0612 | 1 | 0.005 ~ 0.02 | ± 100 | | | |
| | | 3/4 | 0.021 ~ 0.05 | -200 ~ 0 | | | |
| RJ2037 | 0815 | 1 | 0.005 ~ 0.02 | ± 100 | | | |
| RJ3264 ⁽¹⁾ | 1225 | 2 | 0.005 ~ 0.02 | ± 100 | | | |

(1) RJ0816, RJ3264 are under development (sample available)

• Please contact our sales representatives or engineers for other specifications

Power Derating Curve

The rated power is the maximum continuous loading power at 70°C ambient temperature. For ambient temperature above 70°C, the loading power follows the below power derating curve.

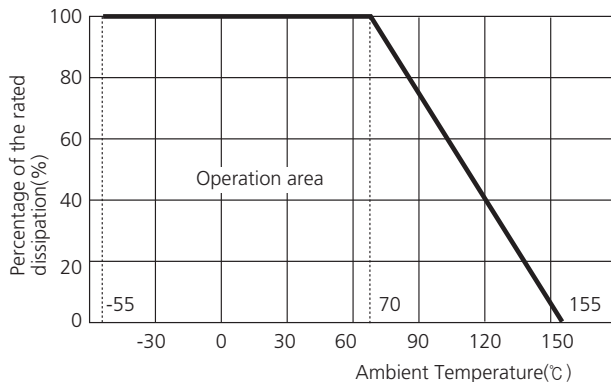

Marking

4-digits coding system

- R means decimal point.
- Other digits represent significant value.
- Example : R010
R010 = .010 = 0.010Ω
= 0.01Ω or 10mΩ

R010

Resistance Value Table

| Code | Value (Ω) | Tol (%) | Code | Value (Ω) | Tol (%) | Code | Value (Ω) | Tol (%) |
|------|-----------|---------|------|-----------|---------|------|-----------|---------|
| R005 | 0.005 | ±1, ±5 | R013 | 0.013 | ±1, ±5 | R030 | 0.030 | ±1, ±5 |
| R006 | 0.006 | ±1, ±5 | R015 | 0.015 | ±1, ±5 | R033 | 0.033 | ±1, ±5 |
| R007 | 0.007 | ±1, ±5 | R016 | 0.016 | ±1, ±5 | R036 | 0.036 | ±1, ±5 |
| R008 | 0.008 | ±1, ±5 | R018 | 0.018 | ±1, ±5 | R039 | 0.039 | ±1, ±5 |
| R009 | 0.009 | ±1, ±5 | R020 | 0.020 | ±1, ±5 | R040 | 0.040 | ±1, ±5 |
| R010 | 0.010 | ±1, ±5 | R022 | 0.022 | ±1, ±5 | R043 | 0.043 | ±1, ±5 |
| R011 | 0.011 | ±1, ±5 | R024 | 0.024 | ±1, ±5 | R047 | 0.047 | ±1, ±5 |
| R012 | 0.012 | ±1, ±5 | R027 | 0.027 | ±1, ±5 | R050 | 0.050 | ±1, ±5 |

The specifications and designs contained herein may be subject to change without notice. Please contact our sales representatives or product engineers before order.

Operation Notes

Example of land Pattern Design

Recommended Soldering Conditions

General Structure

General

Low ohms (RUT Series)

Ultra Low ohms (RU Series)

Ultra Low Ohms (RUK Series)

Ultra Low Ohms (RJ Series)

Arrays (CONVEX Type)

Arrays (CONCAVE Type)

Arrays (FLAT Type)

Anti-Sulfur Resistors

Anti-Sulfur Resistor Arrays(Convex Type)

Anti-Sulfur Resistor Arrays(Concave Type)

Anti-Sulfur Resistor Arrays (Flat Type)

Automotive Anti-sulfur

Automotive Anti-sulfur Arrays (Convex Type)

Attenuator

Characteristics Performance

Packaging

Standard Resistance Value

Arrays(Convex Type)

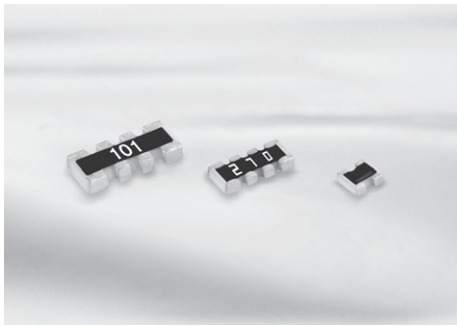

Feature

- Reducing SMD surface area (40% reduced).
- Reducing SMD costs (75% reduced).
- Both flow and reflow soldering are applicable.

The product of lead-free terminal is RoHS compliant. PbO(lead oxide) is included in the glass of our product which is prescribed on RoHS appendix as an exception.

Application

- For semiconductor devices.
- For computers, digital circuits.

Structure and Dimensions

• 2 Array

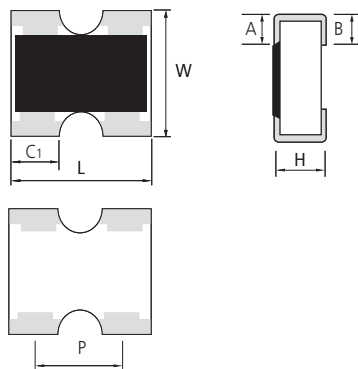

• 4 Array

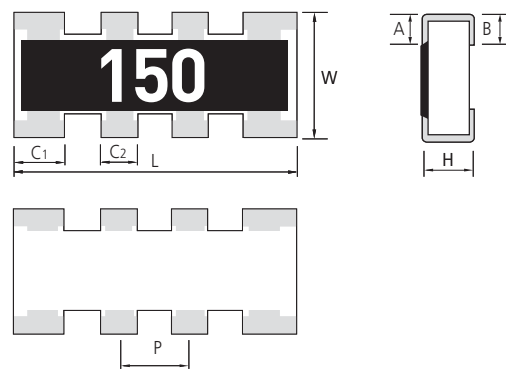

(UNIT: mm)

| Type | L | W | H | A | B | C1 | C2 | P |
|--------|-----------|-----------|-----------|-----------|-----------|-----------|-----------|-----------|
| RP102P | 1.00±0.10 | 1.00±0.10 | 0.35±0.10 | 0.20±0.10 | 0.25±0.10 | 0.33±0.10 | - | 0.65±0.10 |
| RP104P | 2.00±0.10 | 1.00±0.10 | 0.35±0.10 | 0.20±0.10 | 0.25±0.10 | 0.40±0.10 | 0.30±0.10 | 0.50±0.10 |
| RP164P | 3.20±0.10 | 1.60±0.10 | 0.50±0.10 | 0.30±0.15 | 0.30±0.15 | 0.60±0.15 | 0.40±0.15 | 0.80±0.15 |

Parts Numbering System

- The part number system shall be in the following format

| RP Code Designation | 10 Dimension | 4P Resistors | J Tolerance | 100 Resistance Value | CS Packaging Code |
|------------------------|------------------------------------|------------------------------|--|---|--|
| RP: Convex type array | 10 : 0402 Array 16 : 0603 Array | 2P: 2 Pieces 4P: 4 Pieces | F: ±1% G: ±2% J: ±5% ※ Jumper : J | 3 digits coding system (E-24 series) ※ Jumper : '000' | CS : Tape Packaging 7" ES : Tape Packaging 10" AS : Tape Packaging 13" |

Specification

| Type | Size (inch) | Rated Power (W) | Rated Voltage (V) | Max Working Voltage (V) | Tolerance (%) | Resistance Range (Ω) | T.C.R (ppm/°C) | Working Temp. (°C) | Rated Ambient Temp. (°C) | Moisture Level |
|---------|-------------|-----------------|--|-------------------------|---------------|----------------------|----------------|--------------------|--------------------------|----------------|
| RP 102P | 0404 | 1/16 | $\sqrt{P \times R}$ P: Rated Power(W) R: Resistance(Ω) | 50 | ±1(F) | 1 ~ 9.9 10 ~ 1M | ±300 ±200 | -55~155 | 70 | Level 1 |
| RP 104P | 0804 | 1/16 | | 50 | ±2(G) | | | | | |
| RP 164P | 1206 | 1/16 | | 100 | ±5(J) | | | | | |

• Please contact our sales representatives or engineers for other specifications

Power Derating Curve

The rated power is the maximum continuous loading power at 70°C ambient temperature.
For ambient temperature above 70°C, the loading power follows the below power derating curve.

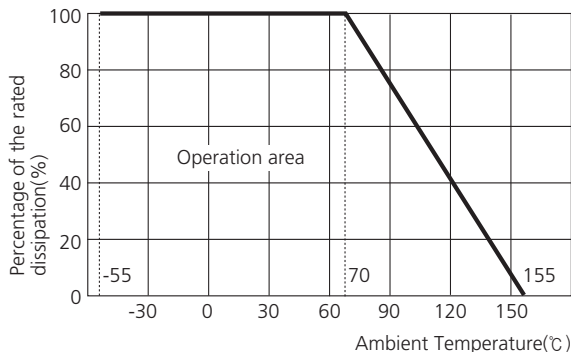

Jumper Rating

| Type | Size (inch) | Rated Current (A) | Resistance (Ω) |
|--------|-------------|-------------------|----------------|
| RP102P | 0404 | 1.0 | 0.05 Max |
| RP104P | 0804 | | |
| RP164P | 1206 | | |

Land Pattern

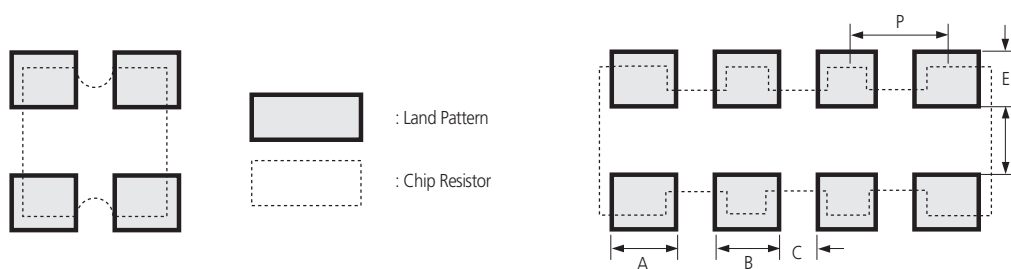

| Type | A | B | C | D | E | P1 | P2 |
|------|-----|-----|------|-----|-----|------|-----|
| 10AT | 0.4 | 0.4 | 0.25 | 0.5 | 0.5 | 0.65 | - |
| 102P | 0.4 | 0.4 | 0.25 | 0.5 | 0.5 | 0.65 | |
| 104P | 0.7 | 0.3 | 0.2 | 0.5 | 0.5 | 0.55 | 0.5 |
| 164P | 0.7 | 0.5 | 0.3 | 0.9 | 0.8 | 0.9 | 0.8 |

The specifications and designs contained herein may be subject to change without notice.
Please contact our sales representatives or product engineers before order.

Operation Notes

Example of land Pattern Design

Recommended Soldering Conditions

General Structure

General

Low ohms (RUT Series)

Ultra Low ohms (RU Series)

Ultra Low Ohms (RUK Series)

Ultra Low Ohms (RJ Series)

Arrays (CONVEX Type)

Arrays (CONCAVE Type)

Arrays (FLAT Type)

Anti-Sulfur Resistors

Anti-Sulfur Resistor Arrays(Convex Type)

Anti-Sulfur Resistor Arrays(Concave Type)

Anti-Sulfur Resistor Arrays (Flat Type)

Automotive Anti-sulfur

Automotive Anti-sulfur Arrays (Convex Type)

Attenuator

Characteristics Performance

Packaging

Standard Resistance Value

Arrays (Concave Type)

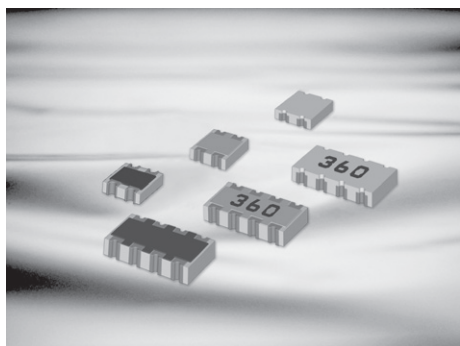

Feature

- Strong Body.
- Both flow and reflow soldering are applicable.
- Concave Type Terminal.

The product of lead-free terminal is RoHS compliant. PhO(lead oxide) is included in the glass of our product which is prescribed on RoHS appendix as an exception.

Application

- For semiconductor devices.
- For computers, digital circuits.

Structure and Dimensions

(1) Concave Type

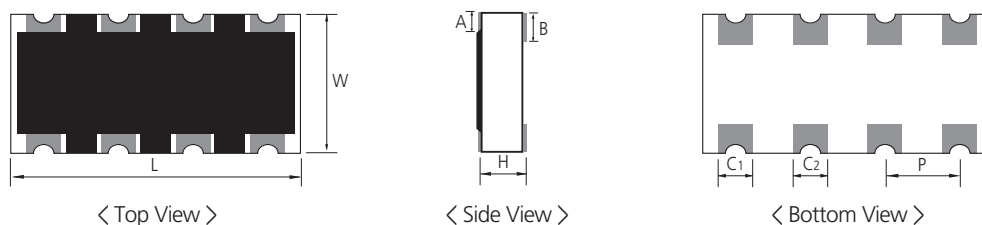

(UNIT: mm)

| Type | L | W | H | A | B | C ₁ | C ₂ | P |
|--------|-----------|-----------|-----------|-----------|-----------|----------------|----------------|-----------|
| RN102P | 1.00±0.10 | 1.00±0.10 | 0.35±0.10 | 0.15±0.10 | 0.25±0.10 | 0.33±0.10 | - | 0.50±0.10 |
| RN104P | 2.00±0.10 | 1.00±0.10 | 0.40±0.10 | 0.15±0.10 | 0.25±0.10 | 0.30±0.10 | 0.30±0.10 | 0.50±0.10 |

(2) Inverted Concave Type

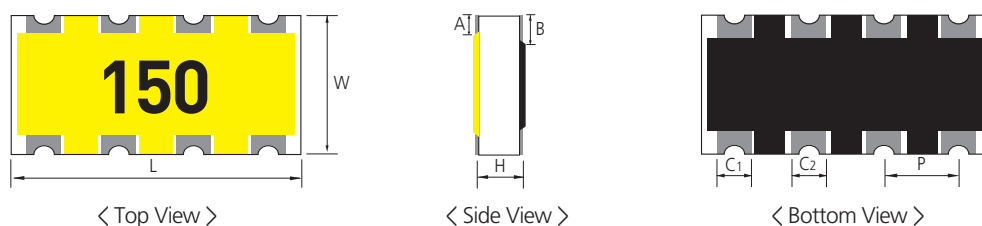

(UNIT: mm)

| Type | L | W | H | A | B | C ₁ | C ₂ | P |
|--------|-----------|-----------|-----------|-----------|-----------|----------------|----------------|-----------|
| RM102P | 1.00±0.10 | 1.00±0.10 | 0.35±0.10 | 0.15±0.10 | 0.25±0.10 | 0.33±0.10 | - | 0.50±0.10 |
| RM104P | 2.00±0.10 | 1.00±0.10 | 0.40±0.10 | 0.15±0.10 | 0.25±0.10 | 0.30±0.10 | 0.30±0.10 | 0.50±0.10 |

(3) Short-free & Inverted Concave Type

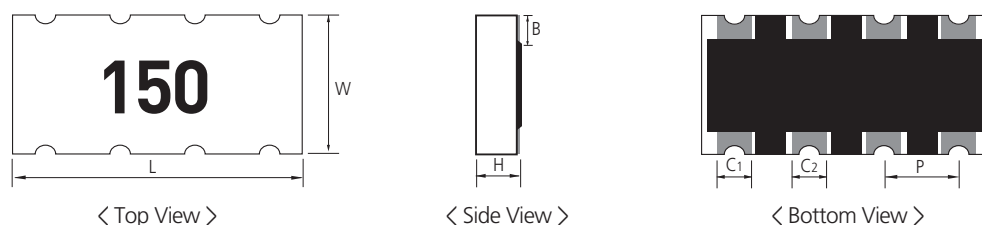

(UNIT: mm)

| Type | L | W | H | A | B | C ₁ | C ₂ | P |
|--------|-----------|-----------|-----------|---|-----------|----------------|----------------|-----------|
| RK102P | 1.00±0.10 | 1.00±0.10 | 0.35±0.10 | - | 0.25±0.10 | 0.33±0.10 | - | 0.50±0.10 |
| RK104P | 2.00±0.10 | 1.00±0.10 | 0.40±0.10 | - | 0.25±0.10 | 0.30±0.10 | 0.30±0.10 | 0.50±0.10 |

Parts Numbering System

- The part number system shall be in the following format

| RN | 10 | 4P | J | 100 | CS |
|--|----------------|------------------------------|----------------------------------|---|---|
| Code Designation | Dimension | Resistors | Tolerance | Resistance Value | Packaging Code |
| RN : Concave Type Array RM : Inverted Type Array RK : Short Free & Inverted Type | 10: 0402 Array | 2P: 2 Pieces 4P: 4 Pieces | F: ±1% J: ±5% ※ Jumper : J | 3 digit coding system (EIA coding system) E-24 series ※ Jumper : '000' | CS : Tape & Reel 7" ES : Tape & Reel 10" AS : Tape & Reel 13" |

Specification

| Type | Size (inch) | Rated Power (W) | Rated Voltage (V) | Max Working Voltage (V) | Tolerance (%) | Resistance Range (Ω) | T.C.R (ppm/°C) | Working Temp. (°C) | Rated Ambient Temp. (°C) | Moisture Level |
|------|-------------|-----------------|--|-------------------------|----------------|----------------------|----------------|--------------------|--------------------------|----------------|
| 102P | 0404 | 1/16 | $\sqrt{P \times R}$ P: Rated Power(W) R: Resistance(Ω) | 25 | ±1(F) | 1 ~ 1M | ±200 | -55~155 | 70 | Level 1 |
| 104P | 0804 | 1/16 | | 25 | ±2(G) ±5(J) | | | | | |

- Please contact our sales representatives or engineers for other specifications

Power Derating Curve

The rated power is the maximum continuous loading power at 70°C ambient temperature.
For ambient temperature above 70°C, the loading power follows the below power derating curve.

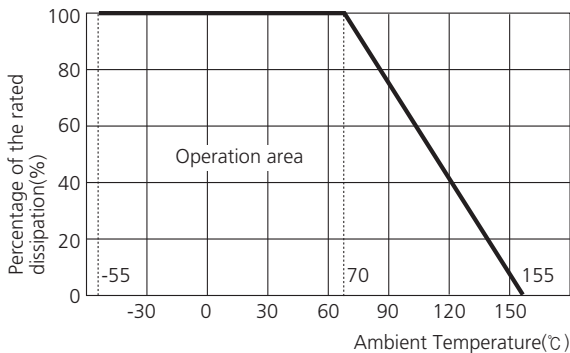

Jumper Rating

| Type | Size (inch) | Rated Current (A) | Resistance (Ω) |
|------|-------------|-------------------|----------------|
| 102P | 0404 | 1.0 | 0.05 Max |
| 104P | 0804 | | |

Land Pattern

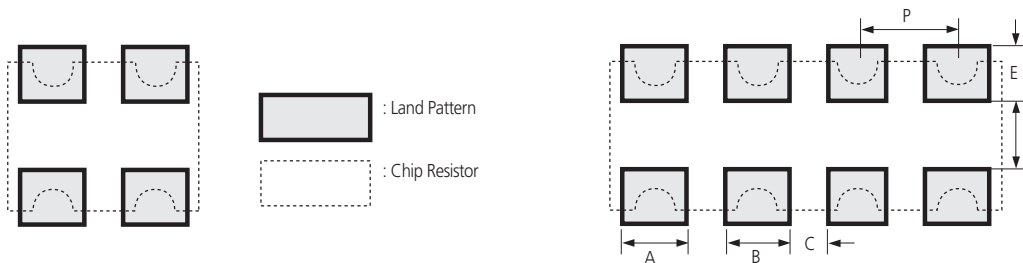

| Type | A | B | C | D | E | P |
|------|-----|-----|-----|-----|-----|-----|
| 102P | 0.3 | 0.3 | 0.2 | 0.5 | 0.4 | 0.5 |
| 104P | 0.3 | 0.3 | 0.2 | 0.5 | 0.4 | 0.5 |

The specifications and designs contained herein may be subject to change without notice.
Please contact our sales representatives or product engineers before order.

Operation Notes

Example of land Pattern Design

Recommended Soldering Conditions

General Structure

General

Low ohms (RUT Series)

Ultra Low ohms (RU Series)

Ultra Low Ohms (RUK Series)

Ultra Low Ohms (RJ Series)

Arrays (CONVEX Type)

Arrays (CONCAVE Type)

Arrays (FLAT Type)

Anti-Sulfur Resistors

Anti-Sulfur Resistor Arrays(Convex Type)

Anti-Sulfur Resistor Arrays(Concave Type)

Anti-Sulfur Resistor Arrays (Flat Type)

Automotive Anti-sulfur

Automotive Anti-sulfur Arrays (Convex Type)

Attenuator

Characteristics Performance

Packaging

Standard Resistance Value

Arrays(Flat Type)

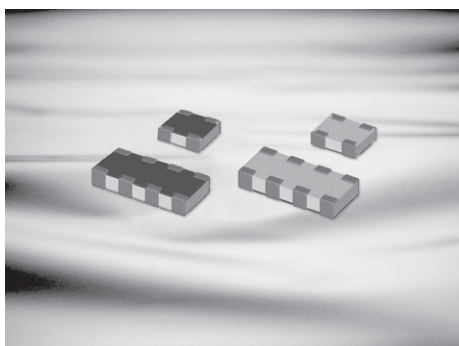

Feature

- Very Small Array.
- Stable and Accurate Resistance.
- Flat Type Terminal.

The product of lead-free terminal is RoHS compliant.
PhO(lead oxide) is included in the glass of our product which is prescribed on RoHS appendix as an exception.

Application

- For semiconductor devices.
- For computers, digital circuits.

Structure and Dimensions

(1) Flat Type Array

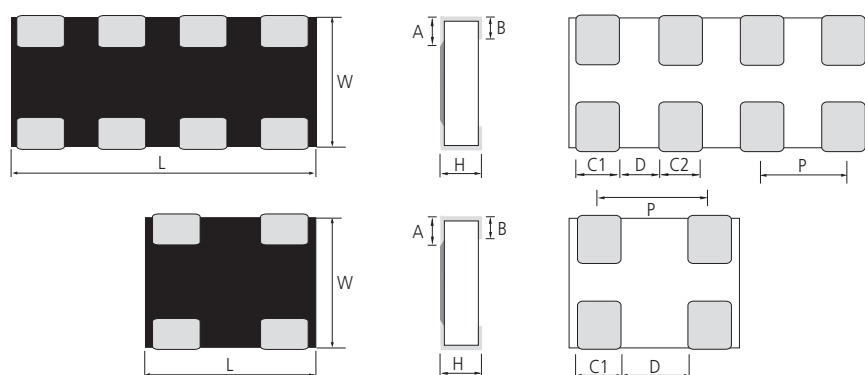

(UNIT: mm)

| Type | L | W | H | A | B | C1 | C2 | P |
|--------|-----------|-----------|-----------|-----------|-----------|-----------|-----------|-----------|
| RF062P | 0.80±0.05 | 0.60±0.05 | 0.23±0.10 | 0.15±0.10 | 0.20±0.10 | 0.25±0.10 | - | 0.50±0.10 |
| RF064P | 1.40±0.05 | 0.60±0.05 | 0.23±0.10 | 0.15±0.10 | 0.20±0.10 | 0.25±0.10 | 0.25±0.10 | 0.40±0.10 |

(2) Inverted Type Array

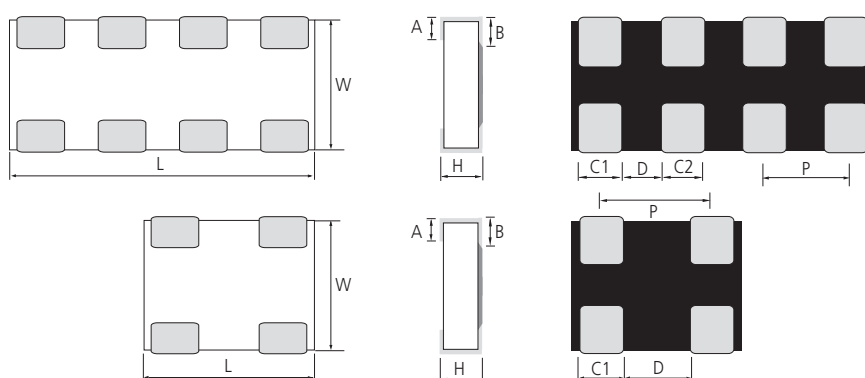

(UNIT: mm)

| Type | L | W | H | A | B | C1 | C2 | P |
|--------|-----------|-----------|-----------|-----------|-----------|-----------|-----------|-----------|
| RM062P | 0.80±0.05 | 0.60±0.05 | 0.23±0.10 | 0.15±0.10 | 0.20±0.10 | 0.25±0.10 | - | 0.50±0.10 |
| RM064P | 1.40±0.05 | 0.60±0.05 | 0.23±0.10 | 0.15±0.10 | 0.20±0.10 | 0.25±0.10 | 0.25±0.10 | 0.40±0.10 |

Parts Numbering System

- The part number system shall be in the following format

| RF | 06 | 4P | J | 150 | CS |
|--|----------------|------------------------------|------------------------|---|---|
| Code Designation | Dimension | Resistors | Tolerance | Resistance Value | Packaging Code |
| RF : Flat Type Array RM : Inverted Type Array | 06: 0201 Array | 2P: 2 Pieces 4P: 4 Pieces | J: ±5% ※ Jumper : J | 3 digit coding system (EIA coding system) E-24 series ※ Jumper : '000' | CS : Tape & Reel 7" ES : Tape & Reel 10" AS : Tape & Reel 13" |

Specification

| Type | Size (inch) | Rated Power (W) | Rated Voltage (V) | Max Working Voltage (V) | Tolerance (%) | Resistance Range (Ω) | T.C.R (ppm/°C) | Working Temp. (°C) | Rated Ambient Temp. (°C) | Moisture Level |
|------|-------------|-----------------|--|-------------------------|---------------|----------------------|----------------|--------------------|--------------------------|----------------|
| 062P | 0302 | 1/32 | $\sqrt{P \times R}$ P: Rated Power(W) R: Resistance(Ω) | 12.5 | ±5(J) | 1 ~ 1M | ±200 | -55~125 | 70 | Level 1 |
| 064P | 0502 | 1/32 | | 12.5 | | | | | | |

- Please contact our sales representatives or engineers for other specifications

Power Derating Curve

The rated power is the maximum continuous loading power at 70°C ambient temperature.
For ambient temperature above 70°C, the loading power follows the below power derating curve.

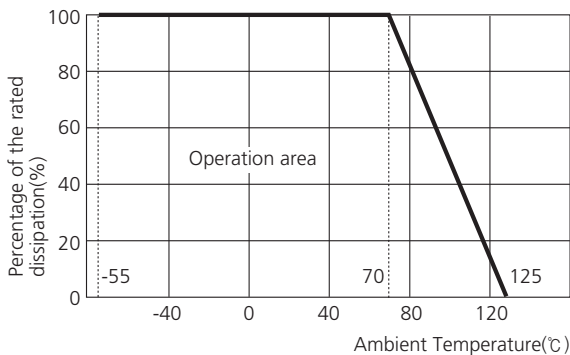

Jumper Rating

| Type | Size (inch) | Rated Current (A) | Resistance (Ω) |
|------|-------------|-------------------|----------------|
| 062P | 0302 | 0.5 | 0.05 Max |
| 064P | 0502 | | |

Land Pattern

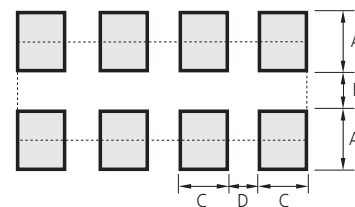
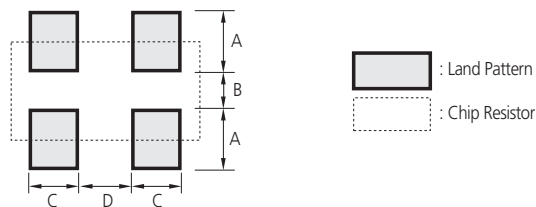

| TYPE (Inch) | Reflow Soldering | | | | |
|-------------|------------------|-----|--------|-----|-----|
| Dimension | A | B | 2A + B | C | D |
| 062P | 0.3 | 0.3 | 0.9 | 0.2 | 0.3 |
| 064P | 0.3 | 0.3 | 0.9 | 0.2 | 0.2 |

The specifications and designs contained herein may be subject to change without notice.
Please contact our sales representatives or product engineers before order.

Operation Notes

Example of land Pattern Design

Recommended Soldering Conditions

General Structure

General

Low ohms (RUT Series)

Ultra Low ohms (RU Series)

Ultra Low Ohms (RUK Series)

Ultra Low Ohms (RJ Series)

Arrays (CONVEX Type)

Arrays (CONCAVE Type)

Arrays (FLAT Type)

Anti-Sulfur Resistors

Anti-Sulfur Resistor Arrays(Convex Type)

Anti-Sulfur Resistor Arrays(Concave Type)

Anti-Sulfur Resistor Arrays (Flat Type)

Automotive Anti-sulfur

Automotive Anti-sulfur Arrays (Convex Type)

Attenuator

Characteristics Performance

Packaging

Standard Resistance Value

Anti-Sulfur Resistors



Feature

- Stable in the Sulfur Atmosphere.
- ASTM B809-95 Satisfied
- Passed 720hrs with the dried Sulfur at 105°C.
- High Precision Reliability.
- RoHS Compliant.

Application

- Electronic Devices with long-term reliability.
- Server System (Memory Module / HDD).
- Network Equipment.

Structure and Dimensions



< Top View >

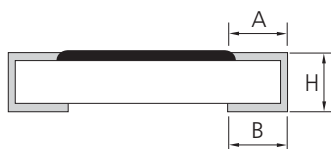

< Side View >

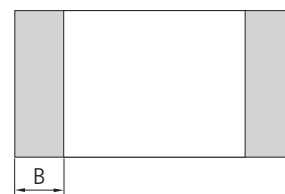

< Bottom View >

(UNIT: mm)

| Type | SIZE(Inch) | L | W | H | A | B |
|---------|------------|-----------|-----------|-----------|-----------|-----------|
| RCS0603 | 0201 | 0.60±0.03 | 0.30±0.03 | 0.23±0.03 | 0.15±0.05 | 0.15±0.05 |
| RCS1005 | 0402 | 1.00±0.05 | 0.50±0.05 | 0.35±0.05 | 0.22±0.10 | 0.25±0.10 |
| RCS1608 | 0603 | 1.60±0.10 | 0.80±0.15 | 0.45±0.10 | 0.30±0.20 | 0.30±0.10 |
| RCS2012 | 0805 | 2.00±0.20 | 1.25±0.15 | 0.55±0.10 | 0.40±0.20 | 0.35±0.20 |
| RCS3216 | 1206 | 3.20±0.20 | 1.60±0.15 | 0.55±0.10 | 0.45±0.20 | 0.40±0.20 |
| RCS3225 | 1210 | 3.20±0.20 | 2.55±0.20 | 0.55±0.10 | 0.45±0.20 | 0.40±0.20 |
| RCS5025 | 2010 | 5.00±0.20 | 2.50±0.20 | 0.55±0.10 | 0.60±0.20 | 0.60±0.20 |
| RCS6432 | 2512 | 6.30±0.20 | 3.20±0.20 | 0.55±0.10 | 0.60±0.20 | 0.60±0.20 |

Parts Numbering System

- The part number system shall be in the following format

| RCS | 2012 | J | 100 | CS |
|----------------------------------|--|--|--|--|
| Code Designation | Dimension & Size Code | Tolerance | Resistance Value | Packaging Code |
| RCS: Anti-sulfur General Type | 0603: 0.6×0.3(mm) - 0201(inch) 1005: 1.0×0.5(mm) - 0402(inch) 1608: 1.6×0.8(mm) - 0603(inch) 2012: 2.0×1.2(mm) - 0805(inch) 3216: 3.2×1.6(mm) - 1206(inch) 3225: 3.2×2.5(mm) - 1210(inch) 5025: 5.0×2.5(mm) - 2010(inch) 6432: 6.4×3.2(mm) - 2512(inch) | D: ±0.5% F: ±1% G: ±2% J: ±5% ※ Jumper : J | 3 or 4 digits coding system (EIA coding system) 3digits (E-24 series) 4digits (E-96 series) ※ Jumper : '000' | CS: Tape & Reel 7" ES: Tape & Reel 10" AS: Tape & Reel 13" |

Specification

| Type | Size (inch) | Rated Power (W) | Rated Voltage (V) | Max Working Voltage (V) | Tolerance (%) | Resistance Range (Ω) | T.C.R (ppm/°C) | Working Temp. (°C) | Rated Ambient Temp. (°C) | Moisture Level |
|---------|-------------|-----------------|---|-------------------------|--|----------------------|------------------------|--------------------|--------------------------|----------------|
| RCS0603 | 0201 | 1/20 | $\sqrt{P \times R}$ P: Rated Power(W) R: Resistance (Ω) | 25 | ±1(F) ±2(G) ±5(J) | 1 ~ 9.9 10 ~ 10M | ±300 ±250 | -55~125 | 70 | Level 1 |
| RCS1005 | 0402 | 1/16 | | 50 | $\pm 0.5(D)$ $\pm 1(F)$ $\pm 2(G)$ $\pm 5(J)$ | 1 ~ 9.9 10 ~ 10M | ± 300 ± 100 | -55~155 | | |
| RCS1608 | 0603 | 1/10 | | 50 | | | | | | |
| RCS2012 | 0805 | 1/8 | | 150 | | | | | | |
| RCS3216 | 1206 | 1/4 | | 200 | | | | | | |
| RCS3225 | 1210 | 1/3 | | 200 | | | | | | |
| RCS5025 | 2010 | 2/3 | | 200 | | | | | | |
| RCS6432 | 2516 | 1 | | 200 | | | | | | |

• Please contact our sales representatives or engineers for other specifications

Power Derating Curve

The rated power is the maximum continuous loading power at 70°C ambient temperature.

For ambient temperature above 70°C, the loading power follows the below power derating curve.

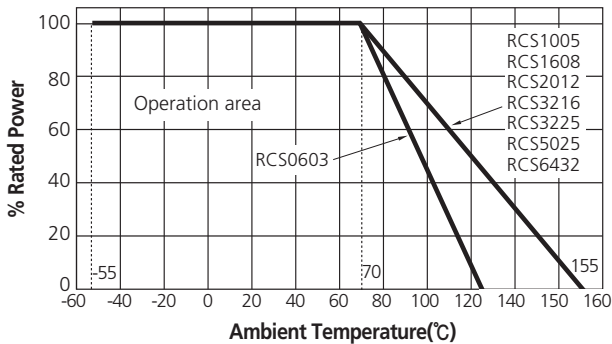

Jumper Rating

| Type | Size (inch) | Rated Current (A) | Resistance (Ω) |
|---------|-------------|-------------------|----------------|
| RCS0603 | 0201 | 0.5 | 0.05 Max |
| RCS1005 | 0402 | 1.0 | |
| RCS1608 | 0603 | | |
| RCS2012 | 0805 | | |
| RCS3216 | 1206 | 2.0 | |
| RCS3225 | 1210 | | |
| RCS5025 | 2010 | | |
| RCS6432 | 2512 | | |

Sulfur Corrosion Test

| Test name | Adding Material | Temp. | Duration Time | Decision Criteria |
|------------------------------|---|-------|---------------|-------------------|
| ASTM B 809-95 | Sulfur 50 g KNO ₃ 200 g DI water 200ml | 50°C | 720hrs | ΔR < ±1% |
| Dry Sulfur (IBM recommended) | Sulfur 50 g | 105°C | 720hrs | ΔR < ±1% |

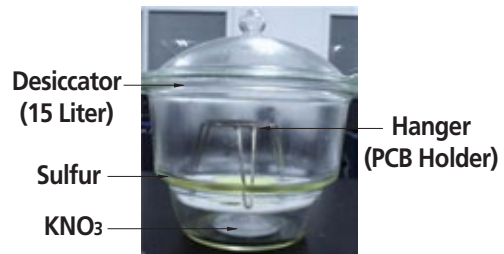

[Test Equipment]

Operation Notes

Example of land Pattern Design

Recommended Soldering Conditions

General Structure

General

Low ohms (RUT Series)

Ultra Low ohms (RU Series)

Ultra Low Ohms (RUK Series)

Ultra Low Ohms (RJ Series)

Arrays (CONVEX Type)

Arrays (CONCAVE Type)

Arrays (FLAT Type)

Anti-Sulfur Resistors

Anti-Sulfur Resistor Arrays (Convex Type)

Anti-Sulfur Resistor Arrays (Concave Type)

Anti-Sulfur Resistor Arrays (Flat Type)

Automotive Anti-sulfur

Automotive Anti-sulfur Arrays (Convex Type)

Attenuator

Characteristics Performance

Packaging

Standard Resistance Value

Anti-Sulfur Resistor Arrays (Convex Type)

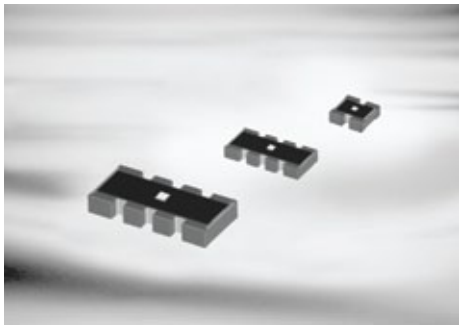

Feature

- Stable in the Sulfur Atmosphere.
- ASTM Satisfied
- Passed 720hrs with the dried Sulfur at 105°C.
- High Precision Reliability.
- RoHS Compliant.

Application

- Electronic Devices with long-term reliability.
- Server System (Memory Module / HDD).
- Network Equipment.
- Automotive ECU parts

Structure and Dimensions

• 2 Array

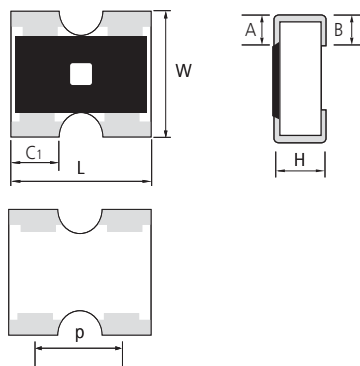

• 4 Array

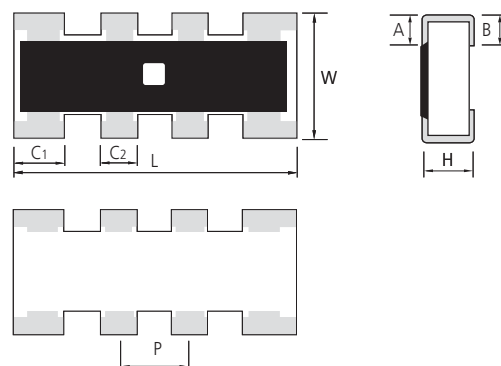

(UNIT: mm)

| Type | L | W | H | A | B | C1 | C2 | P |
|---------|-----------|-----------|-----------|-----------|-----------|-----------|-----------|-----------|
| RPS102P | 1.00±0.10 | 1.00±0.10 | 0.35±0.10 | 0.20±0.10 | 0.25±0.10 | 0.33±0.10 | - | 0.65±0.10 |
| RPS104P | 2.00±0.10 | 1.00±0.10 | 0.35±0.10 | 0.20±0.10 | 0.25±0.10 | 0.40±0.10 | 0.30±0.10 | 0.50±0.10 |
| RPS164P | 3.20±0.10 | 1.60±0.10 | 0.50±0.10 | 0.30±0.15 | 0.30±0.15 | 0.60±0.15 | 0.40±0.15 | 0.80±0.15 |

Parts Numbering System

• The part number system shall be in the following format

| RPS | 10 | 4P | J | 100 | CS |
|--|------------------------------------|------------------------------|--|--|--|
| Code Designation | Dimension | Resistors | Tolerance | Resistance Value | Packaging Code |
| RPS : Anti-Sulfur Array (Convex Type) | 10 : 0402 Array 16 : 0603 Array | 2P: 2 Pieces 4P: 4 Pieces | F: ±1% G: ±2% J: ±5% * Jumper : J | 3 or 4 digits coding system (EIA coding system) 3digits (E-24 series) 4digits (E-96 series) * Jumper : '000' | CS : Tape Packaging 7" ES : Tape Packaging 10" AS : Tape Packaging 13" |

Specification

| Type | Size (inch) | Rated Power (W) | Rated Voltage (V) | Max Working Voltage (V) | Tolerance (%) | Resistance Range (Ω) | T.C.R (ppm/°C) | Working Temp. (°C) | Rated Ambient Temp. (°C) | Moisture Level |
|----------|-------------|-----------------|--|-------------------------|---------------|----------------------|----------------|--------------------|--------------------------|----------------|
| RPS 102P | 0404 | 1/16 | $\sqrt{P \times R}$ P: Rated Power(W) R: Resistance(Ω) | 50 | ±1(F) | 1 ~ 9.9 10 ~ 1M | ±300 ±200 | -55~155 | 70 | Level 1 |
| RPS 104P | 0804 | 1/16 | | 50 | ±2(G) | | | | | |
| RPS 164P | 1206 | 1/16 | | 100 | ±5(J) | | | | | |

• Please contact our sales representatives or engineers for other specifications

Power Derating Curve

The rated power is the maximum continuous loading power at 70°C ambient temperature.
For ambient temperature above 70°C, the loading power follows the below power derating curve.

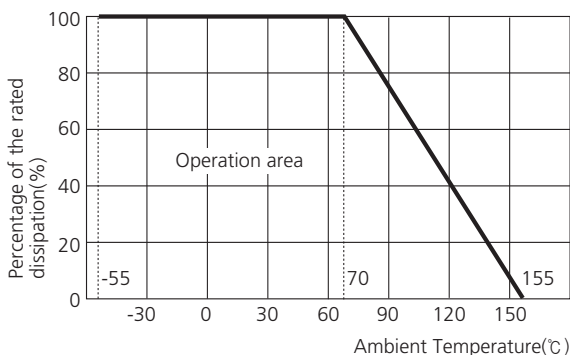

Jumper Rating

| Type | Size (inch) | Rated Current (A) | Resistance (Ω) |
|---------|-------------|-------------------|----------------|
| RPS102P | 0404 | 1.0 | 0.05 Max |
| RPS104P | 0804 | | |
| RPS164P | 1206 | | |

Land Pattern

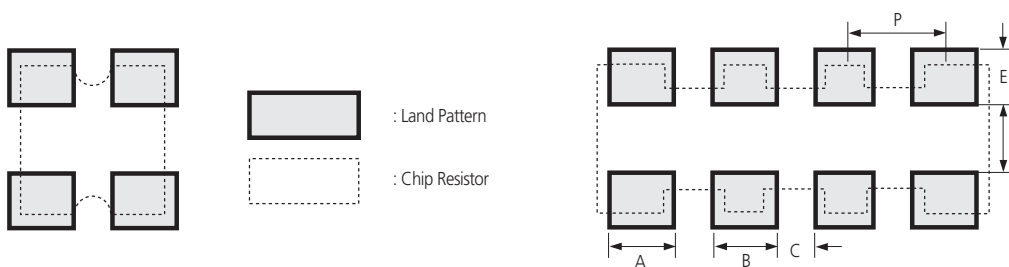

| Type | A | B | C | D | E | P1 | P2 |
|------|-----|-----|------|-----|-----|------|-----|
| 102P | 0.4 | 0.4 | 0.25 | 0.5 | 0.5 | 0.65 | - |
| 104P | 0.7 | 0.3 | 0.2 | 0.5 | 0.5 | 0.55 | 0.5 |
| 164P | 0.7 | 0.5 | 0.3 | 0.9 | 0.8 | 0.9 | 0.8 |

The specifications and designs contained herein may be subject to change without notice.
Please contact our sales representatives or product engineers before order.

Operation Notes

Example of land Pattern Design

Recommended Soldering Conditions

General Structure

General

Low ohms (RUT Series)

Ultra Low ohms (RU Series)

Ultra Low Ohms (RUK Series)

Ultra Low Ohms (RJ Series)

Arrays (CONVEX Type)

Arrays (CONCAVE Type)

Arrays (FLAT Type)

Anti-Sulfur Resistors

Anti-Sulfur Resistor Arrays(Convex Type)

Anti-Sulfur Resistor Arrays(Concave Type)

Anti-Sulfur Resistor Arrays (Flat Type)

Automotive Anti-sulfur

Automotive Anti-sulfur Arrays (Convex Type)

Attenuator

Characteristics Performance

Packaging

Standard Resistance Value

Anti-Sulfur Resistor Arrays (Concave Type)

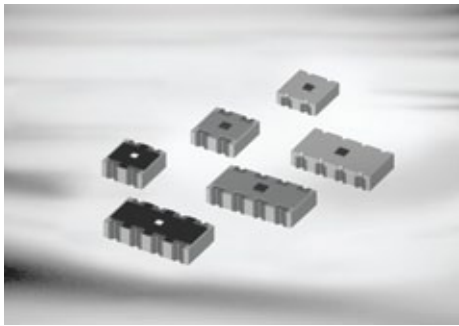

Feature

- Stable in the Sulfur Atmosphere.
- ASTM Satisfied
- Passed 720hrs with the dried Sulfur at 105°C.
- High Precision Reliability.
- RoHS Compliant.

Application

- Electronic Devices with long-term reliability.
- Server System (Memory Module / HDD).
- Network Equipment.
- Automotive ECU parts

Structure and Dimensions

(1) Concave Type

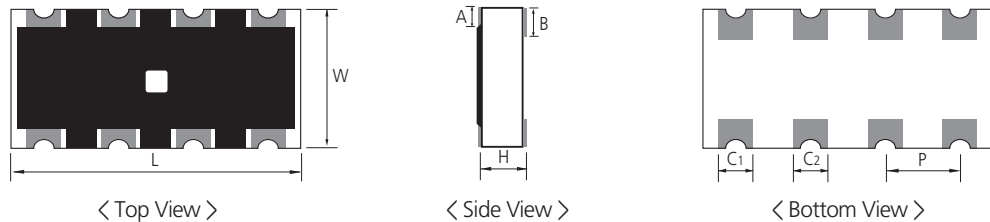

(UNIT: mm)

| Type | L | W | H | A | B | C ₁ | C ₂ | P |
|---------|-----------|-----------|-----------|-----------|-----------|----------------|----------------|-----------|
| RNS102P | 1.00±0.10 | 1.00±0.10 | 0.35±0.10 | 0.15±0.10 | 0.25±0.10 | 0.33±0.10 | - | 0.50±0.10 |
| RNS104P | 2.00±0.10 | 1.00±0.10 | 0.40±0.10 | 0.15±0.10 | 0.25±0.10 | 0.30±0.10 | 0.30±0.10 | 0.50±0.10 |

(2) Inverted Concave Type

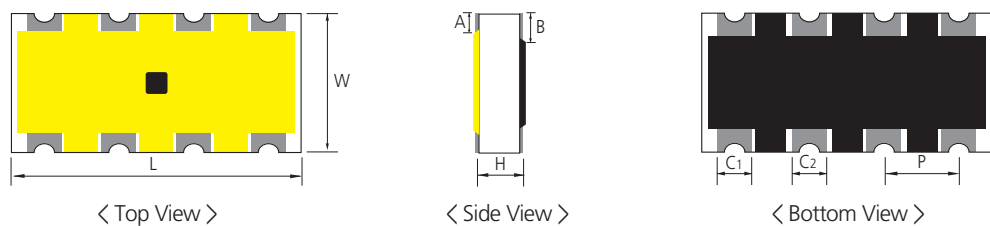

(UNIT: mm)

| Type | L | W | H | A | B | ¹ C ₁ | C ₂ | P |
|---------|-----------|-----------|-----------|-----------|-----------|-----------------------------|----------------|-----------|
| RMS102P | 1.00±0.10 | 1.00±0.10 | 0.35±0.10 | 0.15±0.10 | 0.25±0.10 | 0.33±0.10 | - | 0.50±0.10 |
| RMS104P | 2.00±0.10 | 1.00±0.10 | 0.40±0.10 | 0.15±0.10 | 0.25±0.10 | 0.30±0.10 | 0.30±0.10 | 0.50±0.10 |

(3) Short-free & Inverted Concave Type

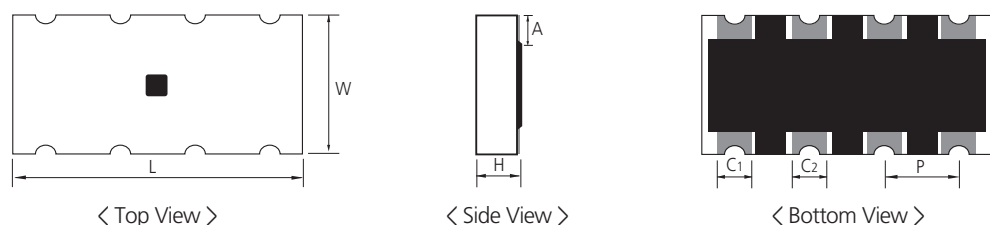

(UNIT: mm)

| Type | L | W | H | A | B | C ₁ | C ₂ | P |
|---------|-----------|-----------|-----------|---|-----------|----------------|----------------|-----------|
| RKS102P | 1.00±0.10 | 1.00±0.10 | 0.35±0.10 | - | 0.25±0.10 | 0.33±0.10 | - | 0.50±0.10 |
| RKS104P | 2.00±0.10 | 1.00±0.10 | 0.40±0.10 | - | 0.25±0.10 | 0.30±0.10 | 0.30±0.10 | 0.50±0.10 |

Parts Numbering System

- The part number system shall be in the following format

| RMS Code Designation | 10 Dimension | 4P Resistors | J Tolerance | 100 Resistance Value | CS Packaging Code |
|--|-----------------|------------------------------|----------------------------------|---|---|
| RNS : Anti-sulfur Array (Concave Type) RMS : Anti-sulfur Array (Inverted Concave) RKS : Anti-sulfur Array (Short-free & Inverted) | 10: 0402 Array | 2P: 2 Pieces 4P: 4 Pieces | F: ±1% J: ±5% ※ Jumper : J | 3 digit coding system (EIA coding system) E-24 series ※ Jumper : '000' | CS : Tape & Reel 7" ES : Tape & Reel 10" AS : Tape & Reel 13" |

Specification

| Type | Size (inch) | Rated Power (W) | Rated Voltage (V) | Max Working Voltage (V) | Tolerance (%) | Resistance Range (Ω) | T.C.R (ppm/°C) | Working Temp. (°C) | Rated Ambient Temp. (°C) | Moisture Level |
|------|----------------|--------------------|--|----------------------------|-------------------------|-------------------------|-------------------|-----------------------|-----------------------------|----------------|
| 102P | 0404 | 1/16 | $\sqrt{P \times R}$ P: Rated Power(W) R: Resistance(Ω) | 25 | ±1(F) ±2(G) ±5(J) | 1 ~ 1M | ±200 | -55~155 | 70 | Level 1 |
| 104P | 0804 | 1/16 | | 25 | | | | | | |

- Please contact our sales representatives or engineers for other specifications

Power Derating Curve

The rated power is the maximum continuous loading power at 70°C ambient temperature.
For ambient temperature above 70°C, the loading power follows the below power derating curve.

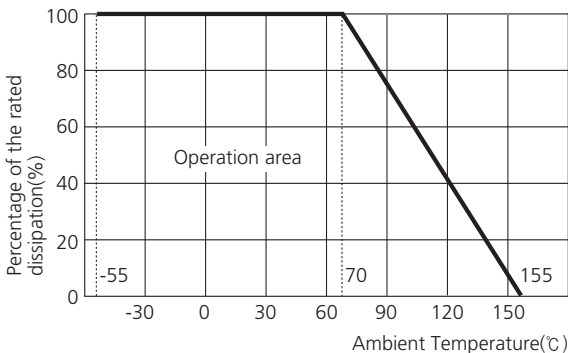

Jumper Rating

| Type | Size (inch) | Rated Current (A) | Resistance (Ω) |
|------|----------------|----------------------|-------------------|
| 102P | 0404 | 1.0 | 0.05 Max |
| 104P | 0804 | | |

Land Pattern

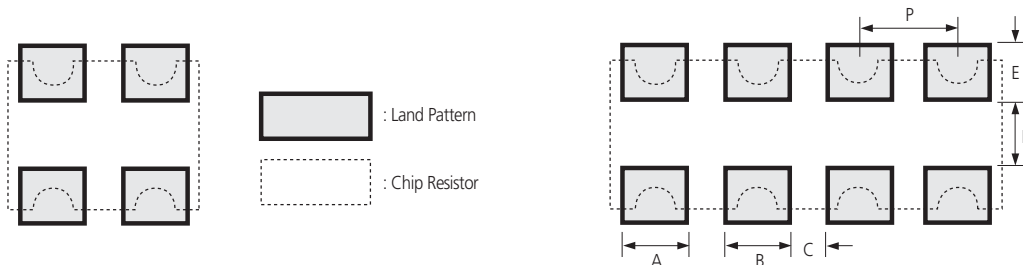

| Type | A | B | C | D | E | P |
|------|-----|-----|-----|-----|-----|-----|
| 102P | 0.3 | 0.3 | 0.2 | 0.5 | 0.4 | 0.5 |
| 104P | 0.3 | 0.3 | 0.2 | 0.5 | 0.4 | 0.5 |

The specifications and designs contained herein may be subject to change without notice.
Please contact our sales representatives or product engineers before order.

Operation Notes

Example of land Pattern Design

Recommended Soldering Conditions

General Structure

General

Low ohms (RUT Series)

Ultra Low ohms (RU Series)

Ultra Low Ohms (RUK Series)

Ultra Low Ohms (RJ Series)

Arrays (CONVEX Type)

Arrays (CONCAVE Type)

Arrays (FLAT Type)

Anti-Sulfur Resistors

Anti-Sulfur Resistor Arrays(Convex Type)

Anti-Sulfur Resistor Arrays(Convex Type)

Anti-Sulfur Resistor Arrays (Flat Type)

Automotive Anti-sulfur

Automotive Anti-sulfur Arrays (Convex Type)

Attenuator

Characteristics Performance

Packaging

Standard Resistance Value

Anti-Sulfur Resistor Arrays (Flat Type)

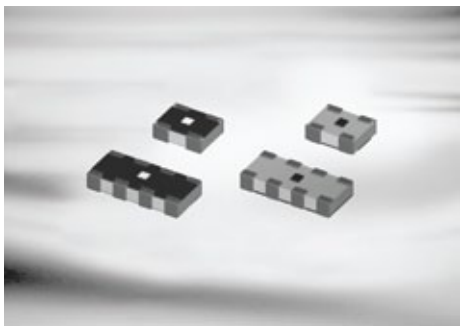

Feature

- Stable in the Sulfur Atmosphere.
- ASTM Satisfied
- Passed 720hrs with the dried Sulfur at 105°C.
- High Precision Reliability.
- RoHS Compliant.

Application

- Electronic Devices with long-term reliability.
- Server System (Memory Module / HDD).
- Network Equipment.
- Automotive ECU parts

Structure and Dimensions

(1) Flat Type Array

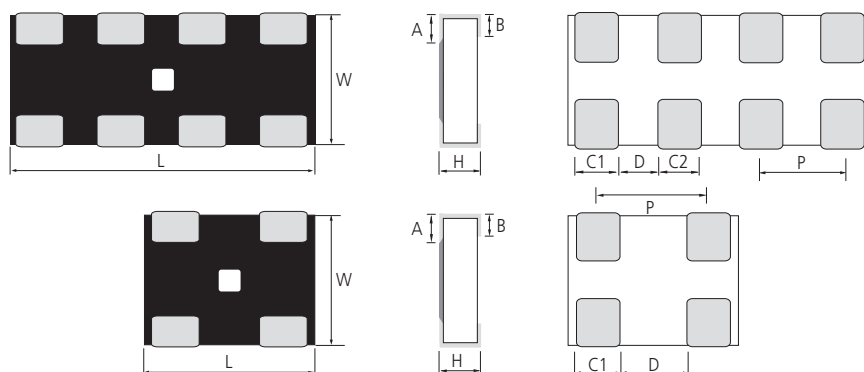

(UNIT: mm)

| Type | L | W | H | A | B | C1 | C2 | P |
|---------|-----------|-----------|-----------|-----------|-----------|-----------|-----------|-----------|
| RFS062P | 0.80±0.05 | 0.60±0.05 | 0.23±0.10 | 0.15±0.10 | 0.20±0.10 | 0.25±0.10 | - | 0.50±0.10 |
| RFS064P | 1.40±0.05 | 0.60±0.05 | 0.23±0.10 | 0.15±0.10 | 0.20±0.10 | 0.25±0.10 | 0.25±0.10 | 0.40±0.10 |

(2) Inverted Type Array

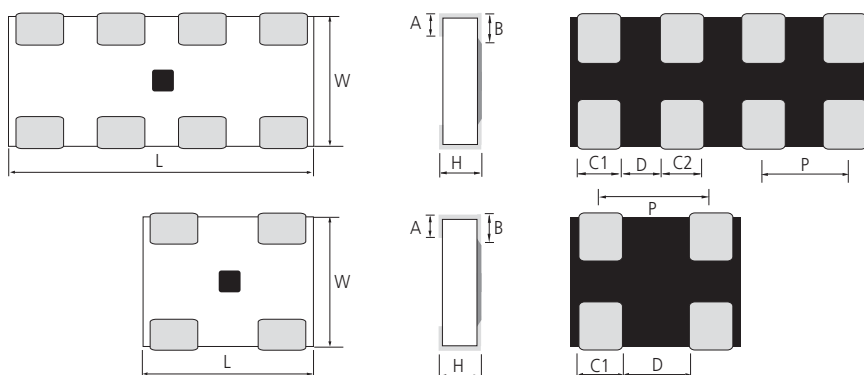

(UNIT: mm)

| Type | L | W | H | A | B | C1 | C2 | P |
|---------|-----------|-----------|-----------|-----------|-----------|-----------|-----------|-----------|
| RFS062P | 0.80±0.05 | 0.60±0.05 | 0.23±0.10 | 0.15±0.10 | 0.20±0.10 | 0.25±0.10 | - | 0.50±0.10 |
| RFS064P | 1.40±0.05 | 0.60±0.05 | 0.23±0.10 | 0.15±0.10 | 0.20±0.10 | 0.25±0.10 | 0.25±0.10 | 0.40±0.10 |

Parts Numbering System

- The part number system shall be in the following format

| RFS | 06 | 4P | J | 150 | CS |
|---|----------------|------------------------------|------------------------|---|---|
| Code Designation | Dimension | Resistors | Tolerance | Resistance Value | Packaging Code |
| RFS : Anti-sulfur Array (Flat Type) RMS : Anti-sulfur Array (Inverted & Flat Type) | 06: 0201 Array | 2P: 2 Pieces 4P: 4 Pieces | J: ±5% ※ Jumper : J | 3 digit coding system (EIA coding system) E-24 series ※ Jumper : '000' | CS : Tape & Reel 7" ES : Tape & Reel 10" AS : Tape & Reel 13" |

Specification

| Type | Size (inch) | Rated Power (W) | Rated Voltage (V) | Max Working Voltage (V) | Tolerance (%) | Resistance Range (Ω) | T.C.R (ppm/°C) | Working Temp. (°C) | Rated Ambient Temp. (°C) | Moisture Level |
|------|-------------|-----------------|--|-------------------------|---------------|----------------------|----------------|--------------------|--------------------------|----------------|
| 062P | 0302 | 1/32 | $\sqrt{P \times R}$ P: Rated Power(W) R: Resistance(Ω) | 12.5 | ±5(J) | 1 ~ 1M | ±200 | -55~125 | 70 | Level 1 |
| 064P | 0502 | 1/32 | | 12.5 | | | | | | |

- Please contact our sales representatives or engineers for other specifications

Power Derating Curve

The rated power is the maximum continuous loading power at 70°C ambient temperature.
For ambient temperature above 70°C, the loading power follows the below power derating curve.

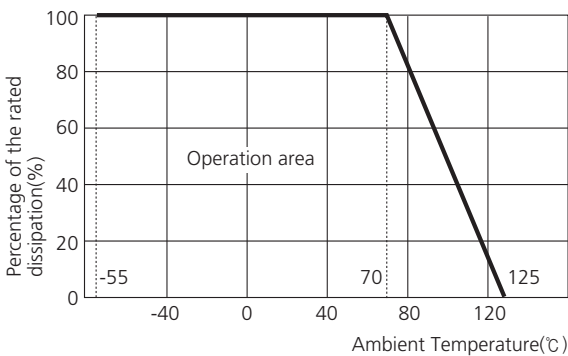

Jumper Rating

| Type | Size (inch) | Rated Current (A) | Resistance (Ω) |
|------|-------------|-------------------|----------------|
| 062P | 0302 | 0.5 | 0.05 Max |
| 064P | 0502 | | |

Land Pattern

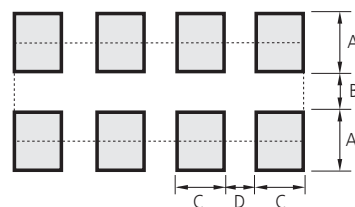
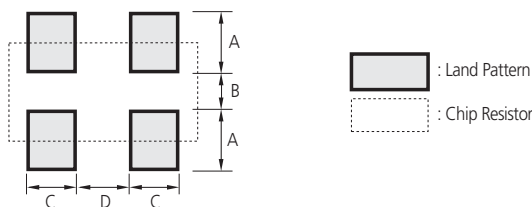

| TYPE (Inch) | Reflow Soldering | | | | |
|-------------|------------------|-----|--------|-----|-----|
| | A | B | 2A + B | C | D |
| 062P | 0.3 | 0.3 | 0.9 | 0.2 | 0.3 |
| 064P | 0.3 | 0.3 | 0.9 | 0.2 | 0.2 |

The specifications and designs contained herein may be subject to change without notice.
Please contact our sales representatives or product engineers before order.

Operation Notes

Example of land Pattern Design

Recommended Soldering Conditions

General Structure

General

Low ohms (RUT Series)

Ultra Low ohms (RU Series)

Ultra Low Ohms (RUK Series)

Ultra Low Ohms (RJ Series)

Arrays (CONVEX Type)

Arrays (CONCAVE Type)

Arrays (FLAT Type)

Anti-Sulfur Resistors

Anti-Sulfur Resistor Arrays(Convex Type)

Anti-Sulfur Resistor Arrays(Concave Type)

Anti-Sulfur Resistor Arrays (Flat Type)

Automotive Anti-sulfur

Automotive Anti-sulfur Arrays (Convex Type)

Attenuator

Characteristics Performance

Packaging

Standard Resistance Value

Automotive Anti-sulfur

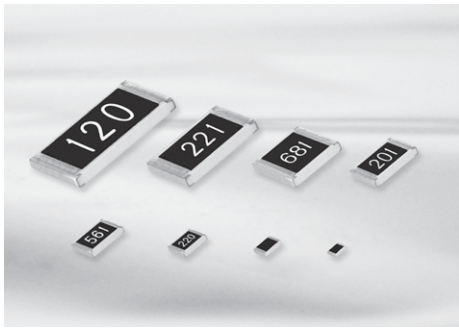

Feature

- AEC-Q200 Qualified.
- ASTM B809-95 satisfied.
- Excellent anti-sulfur performance.
- Lead-free terminal (matt tin)
- RoHS compliant with exemption.

Application

- Electronic Control Units of Automotive Parts
- Automotive grade applications
- Infotainment applications for car.

Structure and Dimensions

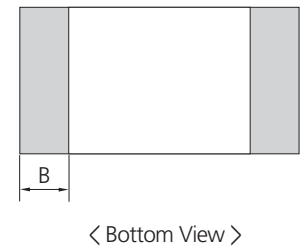
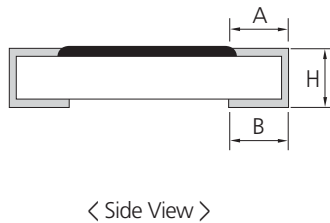
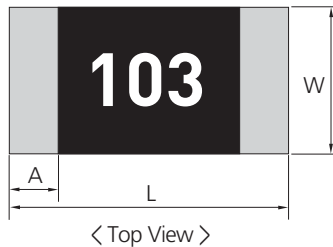

(UNIT: mm)

| Type | SIZE(Inch) | L | W | H | A | B |
|---------|------------|------------|------------|------------|------------|------------|
| RCM0603 | 0201 | 0.60 ±0.03 | 0.30 ±0.03 | 0.23 ±0.03 | 0.10 ±0.05 | 0.15 ±0.05 |
| RCM1005 | 0402 | 1.00 ±0.05 | 0.50 ±0.05 | 0.35 ±0.05 | 0.20 ±0.10 | 0.25 ±0.10 |
| RCM1608 | 0603 | 1.60 ±0.10 | 0.80 ±0.10 | 0.45 ±0.10 | 0.30 ±0.20 | 0.30 ±0.10 |
| RCM2012 | 0805 | 2.00 ±0.15 | 1.25 ±0.15 | 0.50 ±0.10 | 0.40 ±0.20 | 0.35 ±0.20 |
| RCM3216 | 1206 | 3.20 ±0.15 | 1.60 ±0.15 | 0.55 ±0.10 | 0.45 ±0.20 | 0.40 ±0.20 |
| RCM3225 | 1210 | 3.20 ±0.20 | 2.55 ±0.20 | 0.55 ±0.10 | 0.45 ±0.20 | 0.40 ±0.20 |
| RCM5025 | 2010 | 5.00 ±0.20 | 2.50 ±0.20 | 0.55 ±0.10 | 0.60 ±0.20 | 0.60 ±0.20 |
| RCM6432 | 2512 | 6.30 ±0.20 | 3.20 ±0.20 | 0.55 ±0.10 | 0.60 ±0.20 | 0.60 ±0.20 |

- ※ 0402 and smaller size don't have marking on top of the chips.
- ※ 0603 4-digit models(E-96 series) don't have making on top of the chips.

Parts Numbering System

- The part number system shall be in the following format

| RCM | 2 0 1 2 Dimension & Size Code | J Tolerance | 1 0 0 Resistance Value | CS Packaging Code |
|-----------------------------------|----------------------------------|---|--|---|
| RCM : Automotive Chip Resistor | 0603: 0.6×0.3(mm) - 0201(inch) | F : ±1% G : ±2% J : ±5% ※ Jumper : J | 3 or 4 digits coding system (EIA coding system) 3digits (E-24 series) 4digits (E-96 series) ※ Jumper : '000' | CS: Tape Packaging 7" ES: Tape Packaging 10" AS: Tape Packaging 13" |
| | 1005: 1.0×0.5(mm) - 0402(inch) | | | |
| | 1608: 1.6×0.8(mm) - 0603(inch) | | | |
| | 2012: 2.0×1.2(mm) - 0805(inch) | | | |
| | 3216: 3.2×1.6(mm) - 1206(inch) | | | |
| | 3225: 3.2×2.5(mm) - 1210(inch) | | | |
| | 5025: 5.0×2.5(mm) - 2010(inch) | | | |
| | 6432: 6.4×3.2(mm) - 2512(inch) | | | |

Specification

| Type | Size (inch) | Rated Power (W) | Rated Voltage (V) | Max Working Voltage (V) | Tolerance (%) | Resistance Range (Ω) | T.C.R (ppm/°C) | Working Temp. (°C) | Rated Ambient Temp. (°C) | Moisture Level |
|---------|-------------|-----------------|--|-------------------------|------------------------------------|----------------------|----------------|--------------------|--------------------------|----------------|
| RCM0603 | 0201 | 1/20 | $\sqrt{P \times R}$ P: Rated Power(W) R: Resistance(Ω) | 25 | ±1(F) ±2(G) ±5(J) | 1 ~ 9.9 10 ~ 10M | ±300 ±250 | -55~125 | 70 | Level 1 |
| RCM1005 | 0402 | 1/16 | | 50 | ±0.5(D) ±1(F) ±2(G) ±5(J) | 1 ~ 9.9 10 ~ 10M | ±300 ±100 | -55~155 | | |
| RCM1608 | 0603 | 1/10 | | 50 | | | | | | |
| RCM2012 | 0805 | 1/8 | | 150 | | | | | | |
| RCM3216 | 1206 | 1/4 | | 200 | | | | | | |
| RCM3225 | 1210 | 1/3 | | 200 | | | | | | |
| RCM5025 | 2010 | 2/3 | | 200 | | | | | | |
| RCM6432 | 2512 | 1 | | 200 | | | | | | |

• Please contact our sales representatives or engineers for other specifications

Power Derating Curve

The rated power is the maximum continuous loading power at 70°C ambient temperature.
For ambient temperature above 70°C, the loading power follows the below power derating curve.

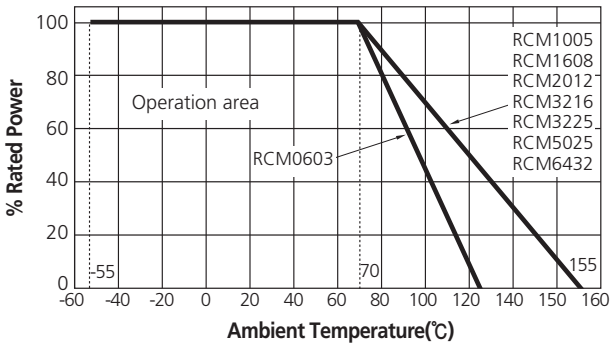

Marking

| • 3 digits indication (E-24 series) | • 4 digits indication (E-96 series) |
|---|---|
| - Left 2 digits represent significant figures. - Last 1 digit represents exponential number of 10. - Example: 103 Left 2 digits: 10 Last 1 digit: 3 $103 = 10 \times 10^3 \Omega$ $= 10000 \Omega = 10k\Omega$ | - Left 3 digits represent significant figures. - Last 1 digit represents exponential number of 10. - Example: 1002 Left 3 digits: 100 Last 1 digit: 2 $1002 = 100 \times 10^2 \Omega$ $= 10000 \Omega = 10k\Omega$ |
| No marking types for 3-digit models : RC0402, RC0603, RC1005 | No marking types for 4-digit models : RC0402, RC0603, RC1005, RC1608 |

Jumper Rating

| Type | Size (inch) | Rated Current (A) | Resistance (A) |
|---------|-------------|-------------------|----------------|
| RCM0603 | 0201 | 0.5 | 0.05 Max |
| RCM1005 | 0402 | 1.0 | |
| RCM1608 | 0603 | | |
| RCM2012 | 0805 | | |
| RCM3216 | 1206 | 2.0 | |
| RCM3225 | 1210 | | |
| RCM5025 | 2010 | | |
| RCM6432 | 2512 | | |

IEC Code System (E-96, E-24)

| E-96 | E-24 | E-96 | E-24 | E-96 | E-24 | E-96 | E-24 |
|------|------|------|------|------|------|------|------|
| 100 | 10 | 178 | | 316 | | 562 | 56 |
| 102 | | 182 | 18 | 324 | 33 | 576 | |
| 105 | | 187 | | 332 | | 590 | |
| 107 | | 191 | | 340 | | 604 | |
| 110 | 11 | 196 | | 348 | | 619 | |
| 113 | | 200 | 20 | 357 | 36 | 634 | 62 |
| 115 | | 205 | | 365 | | 649 | |
| 118 | | 210 | | 374 | | 665 | |
| 121 | 12 | 215 | | 383 | 39 | 681 | 68 |
| 124 | | 221 | 22 | 392 | | 698 | |
| 127 | | 226 | | 402 | | 715 | |
| 130 | 13 | 232 | | 412 | | 732 | |
| 133 | | 237 | | 422 | | 750 | 75 |
| 137 | | 243 | 24 | 432 | 43 | 768 | |
| 140 | | 249 | | 442 | | 787 | |
| 143 | | 255 | | 453 | | 806 | |
| 147 | | 261 | | 464 | | 825 | 82 |
| 150 | 15 | 267 | | 475 | 47 | 845 | |
| 154 | | 274 | 27 | 487 | | 866 | |
| 158 | | 280 | | 499 | | 887 | |
| 162 | 16 | 287 | | 511 | 51 | 909 | |
| 165 | | 294 | | 523 | | 931 | 91 |
| 169 | | 301 | 30 | 536 | | 953 | |
| 174 | | 309 | | 549 | | 976 | |

The specifications and designs contained herein may be subject to change without notice.
Please contact our sales representatives or product engineers before order.

Operation Notes

Example of land Pattern Design

Recommended Soldering Conditions

General Structure

General

Low ohms (RUT Series)

Ultra Low ohms (RU Series)

Ultra Low Ohms (RUK Series)

Ultra Low Ohms (RJ Series)

Arrays (CONVEX Type)

Arrays (CONCAVE Type)

Arrays (FLAT Type)

Anti-Sulfur Resistors

Anti-Sulfur Resistor Arrays(Convex Type)

Anti-Sulfur Resistor Arrays(Concave Type)

Anti-Sulfur Resistor Arrays (Flat Type)

Automotive Anti-sulfur

Automotive Anti-sulfur Arrays (Convex Type)

Attenuator

Characteristics Performance

Packaging

Standard Resistance Value

Automotive Anti-sulfur Arrays (Convex Type)

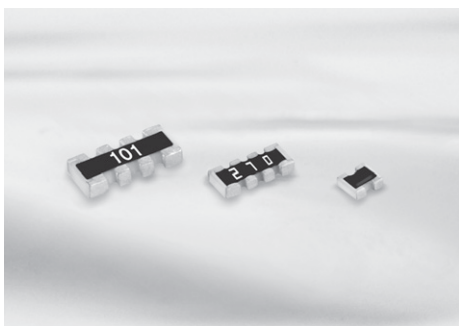

Feature

- AEC-Q200 Qualified.
- ASTM B809-95 satisfied.
- Excellent anti-sulfur performance.
- Lead-free terminal (matt tin)
- RoHS complaint with exemption.

Application

- Electronic Control Units of Automotive Parts
- Automotive grade applications
- Infotainment applications for car.

Structure and Dimensions

• 2 Array

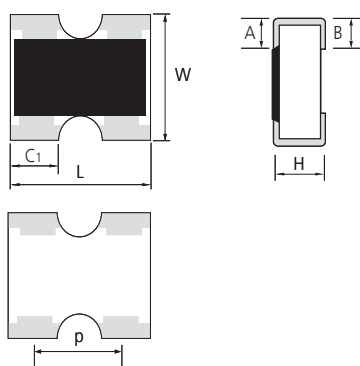

• 4 Array

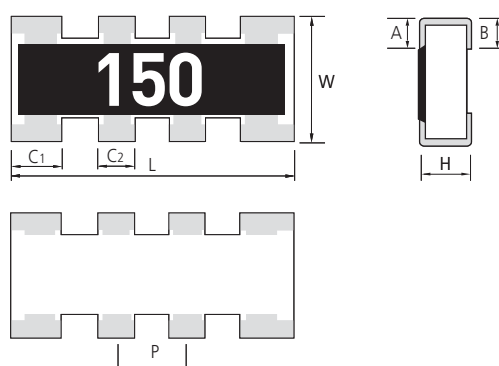

(UNIT: mm)

| Type | L | W | H | A | B | C1 | C2 | P |
|---------|-----------|-----------|-----------|-----------|-----------|-----------|-----------|-----------|
| RPM102P | 1.00±0.10 | 1.00±0.10 | 0.35±0.10 | 0.25±0.10 | 0.25±0.10 | 0.33±0.10 | - | 0.65±0.10 |
| RPM104P | 2.00±0.10 | 1.00±0.10 | 0.35±0.10 | 0.25±0.10 | 0.25±0.10 | 0.40±0.10 | 0.30±0.10 | 0.50±0.10 |
| RPM164P | 3.20±0.10 | 1.60±0.10 | 0.50±0.10 | 0.30±0.15 | 0.30±0.15 | 0.60±0.15 | 0.40±0.15 | 0.80±0.15 |

Parts Numbering System

• The part number system shall be in the following format

| RPM | 10 | 4P | J | 100 | CS |
|--|------------------------------------|------------------------------|--|--|--|
| Code Designation | Dimension | Resistors | Tolerance | Resistance Value | Packaging Code |
| RPM : Automotive Anti-sulfur Array (Convex Type) | 10 : 0402 Array 16 : 0603 Array | 2P: 2 Pieces 4P: 4 Pieces | F: ±1% G: ±2% J: ±5% ※ Jumper : J | 3 or 4 digits coding system (EIA coding system) 3digits (E-24 series) 4digits (E-96 series) ※ Jumper : '000' | CS : Tape Packaging 7" ES : Tape Packaging 10" AS : Tape Packaging 13" |

Specification

| Type | Size (inch) | Rated Power (W) | Rated Voltage (V) | Max Working Voltage (V) | Tolerance (%) | Resistance Range (Ω) | T.C.R (ppm/°C) | Working Temp. (°C) | Rated Ambient Temp. (°C) | Moisture Level |
|----------|-------------|-----------------|--|-------------------------|---------------|----------------------|----------------|--------------------|--------------------------|----------------|
| RPM 102P | 0404 | 1/16 | $\sqrt{P \times R}$ P: Rated Power(W) R: Resistance(Ω) | 50 | ±1(F) | 1 ~ 9.9 10 ~ 1M | ±300 ±200 | -55~155 | 70 | Level 1 |
| RPM 104P | 0804 | 1/16 | | 50 | ±2(G) | | | | | |
| RPM 164P | 1206 | 1/16 | | 100 | ±5(J) | | | | | |

• Please contact our sales representatives or engineers for other specifications

Power Derating Curve

The rated power is the maximum continuous loading power at 70°C ambient temperature.
For ambient temperature above 70°C, the loading power follows the below power derating curve.

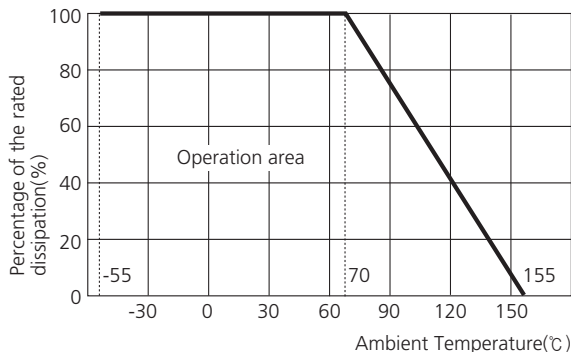

Jumper Rating

| Type | Size (inch) | Rated Current (A) | Resistance (Ω) |
|---------|-------------|-------------------|----------------|
| RPM102P | 0404 | 1.0 | 0.05 Max |
| RPM104P | 0804 | | |
| RPM164P | 1206 | | |

Land Pattern

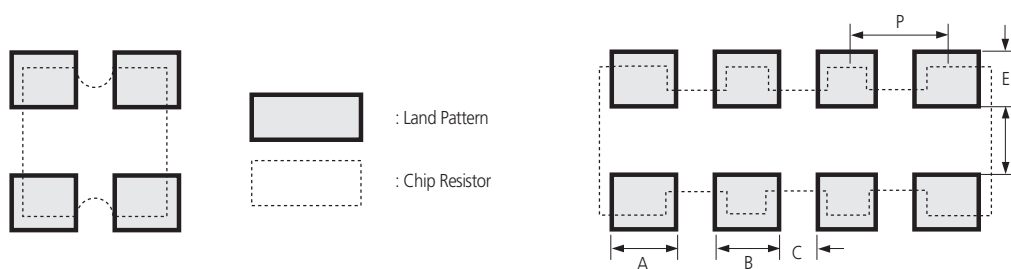

| Type | A | B | C | D | E | P1 | P2 |
|------|-----|-----|------|-----|-----|------|-----|
| 102P | 0.4 | 0.4 | 0.25 | 0.5 | 0.5 | 0.65 | - |
| 104P | 0.7 | 0.3 | 0.2 | 0.5 | 0.5 | 0.55 | 0.5 |
| 164P | 0.7 | 0.5 | 0.3 | 0.9 | 0.8 | 0.9 | 0.8 |

The specifications and designs contained herein may be subject to change without notice.
Please contact our sales representatives or product engineers before order.

Operation Notes

Example of land Pattern Design

Recommended Soldering Conditions

General Structure

General

Low ohms (RUT Series)

Ultra Low ohms (RU Series)

Ultra Low Ohms (RUK Series)

Ultra Low Ohms (RJ Series)

Arrays (CONVEX Type)

Arrays (CONCAVE Type)

Arrays (FLAT Type)

Anti-Sulfur Resistors

Anti-Sulfur Resistor Arrays(Convex Type)

Anti-Sulfur Resistor Arrays(Concave Type)

Anti-Sulfur Resistor Arrays (Flat Type)

Automotive Anti-sulfur

Automotive Anti-sulfur Arrays (Convex Type)

Attenuator

Characteristics Performance

Packaging

Standard Resistance Value

Attenuator

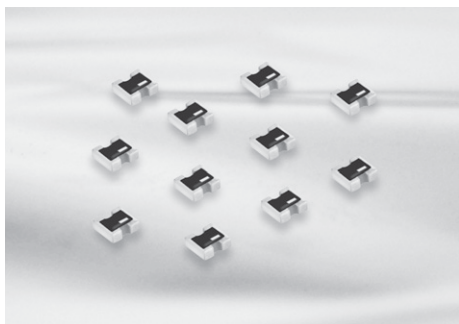

Feature

- The RP10AT is small-size chip Attenuator, suitable for high density surface mounting.
- Unbalanced π type attenuator circuit in one chip(1.0 mm x 1.0 mm).
- Mounting occupation area reduction : about 50 % reduction.
- Mounting cost reduction : Mounting times 3 times \rightarrow 1 time.
- Attenuation : 0 dB to 10 dB.

Application

- Attenuation / level control / impedance matching of high frequency signals of communication equipment; cellular phones(GSM, CDMA, etc.), PHS, PDA, for example.

Structure and Dimensions

• Structure

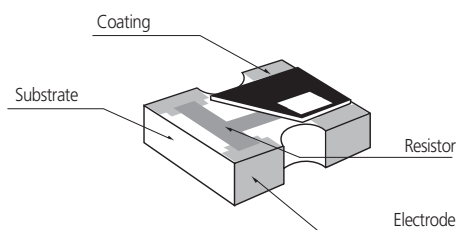

• Dimensions

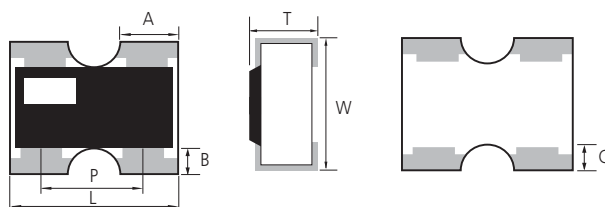

(UNIT: mm)

| Type | Power(W) | L | W | T | A | B | C | P | Average Weight |
|--------|-----------------|-----------------|-----------------|-----------------|-----------------|-----------------|-----------------|-----------------|----------------|
| RP10AT | 0.04W / package | 1.00 \pm 0.10 | 1.00 \pm 0.10 | 0.35 \pm 0.10 | 0.33 \pm 0.05 | 0.20 \pm 0.10 | 0.25 \pm 0.10 | 0.65 \pm 0.10 | 1.1mg |

Parts Numbering System

- The part number system shall be in the following format

| RP | 10AT | L | A | 03 | CS |
|------------------|---|------------------------------------|--------------------------|---------------------------------|-----------------------|
| Code Designation | Dimensions & Circuit Configuration | Attenuation Value Tolerance | Characteristic Impedance | Attenuation Value | Packing Type |
| RP: Convex type | 10:1.0 \times 1.0(mm)-0404(inch) AT: Unbalanced π -type Attenuator | L: \pm 0.3 dB H: \pm 0.5 dB | A: 50 ohm | 3 dB EX) 0 \rightarrow 0dB | CS: Tape Packaging 7" |

Specification

| Item | Specifications |
|---|--|
| Attenuation Value | 0 dB~15dB |
| Attenuation Value Tolerance | 0 dB~5 dB : ± 0.3 dB 6 dB~15dB : ± 0.5 dB |
| Characteristic Impedance | 50 Ω |
| Power Rating | 0.04W / package |
| Frequency Range | DC to 3 GHz |
| VSWR (Voltage Standing Wave Ratio) | 1.3 max |
| Number of terminals | 4 terminals |
| Category Temperature Range (Operating Temperature Range) | -55 °C to +125 °C |

Operation Notes

Example of land Pattern Design

Recommended Soldering Conditions

General Structure

General

Low ohms (RUT Series)

Ultra Low ohms (RU Series)

Ultra Low Ohms (RUK Series)

Ultra Low Ohms (RJ Series)

Arrays (CONVEX Type)

Arrays (CONCAVE Type)

Arrays (FLAT Type)

Anti-Sulfur Resistors

Anti-Sulfur Resistor Arrays(Convex Type)

Anti-Sulfur Resistor Arrays(Concave Type)

Anti-Sulfur Resistor Arrays (Flat Type)

Automotive Anti-sulfur

Automotive Anti-sulfur Arrays (Convex Type)

Attenuator

Characteristics Performance

Packaging

Standard Resistance Value

Power Derating Curve

The rated power is the maximum continuous loading power at 70°C ambient temperature. For ambient temperature above 70°C, the loading power follows the below power derating curve.

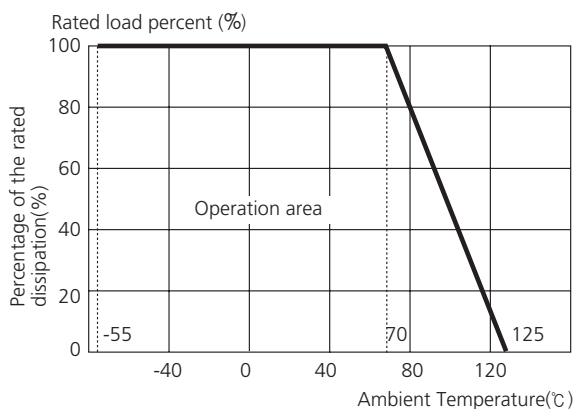

Equivalent Circuit Configuration

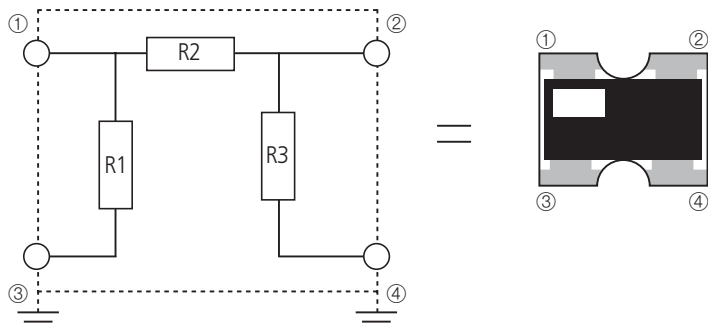

Electrical Characteristic

| Item | Requirements Specification | | Test Methods | |
|---------------------------------|--|--|---|-------------------|
| | Resistor | Jumper | Resistor | Jumper |
| Direct Current Resistance | Within the regulated resistance tolerance. | 50mΩ Max. | JIS C 5201-1 4.5 Voltage apply Within 5 sec. Test temp: 20 °C, 65RH Test board: <FIG. 1> | |
| Temperature Characteristic | 1Ω ≤ R < 10Ω : ±300ppm/°C 10Ω ≤ R ≤ 10MΩ : ±100ppm/°C (0201 size : ±250ppm/°C) | | JIS C 5201-1 4.8 Test Temperature(°C) 20 °C → -55 °C / 20 °C → 125 °C T.C.R(ppm / °C)=(R-R ₂₀) / R ₂₀ × 1/(T-T ₂₀) × 10 ⁶ ※ T=test Temperature, T ₂₀ =20 °C R=Resistance at T, R ₂₀ =Resistance at T ₂₀ Test board: <FIG. 1> | |
| Short-time Overload | ΔR | Less than ±(1% ± 0.1Ω) of the initial value. | JIS C 5201-1 4.13 Apply 2.5 times rated voltage for 5 sec. Wait 60 minutes at room temperature. Measure the resistance value. Test board: <FIG. 1> | Max Surge Current |
| | Visual | No evidence of mechanical damage. | | |
| Intermittent Overload | ΔR | Less than ±(3% ± 0.1Ω) of the initial value. | JIS C 5201-1 4.13 2.5 times of rated voltage . 1 second ON, 25 second OFF. 10,000 cycles. Test board: <FIG. 1> | Max Surge Current |
| | Visual | No evidence of mechanical damage. | | |
| Dielectric Withstanding Voltage | No evidence of mechanical damage. | | JIS C 5201-1 4.7 Apply Voltage for 1 minute 0402.0603:50V 1005, 1608: 100V Other: 500V | |
| Insulation Resistance | Over 1,000MΩ | | | |

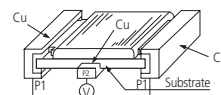

Mechanical Characteristic

| Item | Requirements Specification | | Test Methods | |
|----------------------------------|---|---|--|--------|
| | Resistor | Jumper | Resistor | Jumper |
| Solderability | Coverage: ≥95% each termination. No crack of termination parts and ceramic exposure of surface by melting. | | IEC60068-2-58 Rosin Flux: Rosin 25%, Methanol 75% Solder Temp.: 245±5/-0 °C Dipping time: 2±0.5 sec.(Both side dipping) | |
| Bending Test | ΔR | Less than ±(1.0% ± 0.05Ω) of the initial value. | JIS C 5201-1 4.33 After soldering resistor on the PCB, 3mm of bending shall be applied for 10 sec. Test board: <FIG. 2> | |
| | Visual | No evidence of mechanical damage. | | |
| Adhesive strength of termination | ·No mechanical damage or sign of disconnection | | JIS C 5201-1(4.16) - Test strength : 5N (500g · f), 0603 : 2N - Test time : Applying pressure for 10 seconds | |
| Resistance to Soldering Heat | ΔR | Less than ±(1% ± 0.05Ω) of the initial value. | JIS C 5201-1 4.18 - Flow soldering : 260±5 °C, 10 sec. max.(both side dipping) - Reflow soldering : 260±5 °C, 10 sec. max. over 230 °C, 30~40 sec. | |
| | Visual | No evidence of mechanical damage. | | |
| Anti-Vibration Test | ΔR | Less than ±(1% ± 0.05Ω) of the initial value. | JIS C 5201-1 4.22 2 hours each in X, Y and Z axis(total 6 hours) 10 to 55Hz sweep in 1 minute at 1.5mm amplitude. | |
| | Visual | No evidence of mechanical damage. | | |

Environmental Characteristic

| Item | Requirements Specification | | Test Methods | |
|---------------------|----------------------------|--|--------------|--|
| | Resistor | Jumper | Resistor | Jumper |
| Temperature Cycle | ΔR | Less than $\pm(1\% \pm 0.1\Omega)$ of the initial value. | 50mΩ Max. | JIS C 5201-1 4.19 Perform 100 cycles as follows. Test Condition: -55°C / 30min ↔ 125°C / 30min sweep time: 5 min Test board: <FIG. 1> |
| | Visual | No evidence of mechanical damage. | | |
| Load Life | ΔR | Less than $\pm(3\% \pm 0.1\Omega)$ of the initial value. | 50mΩ Max. | JIS C 5201-1 4.25 Test Voltage: rated voltage Test temp.: 70±2°C Time: 1,000 ⁺⁴⁸ hours(90 min; ON, 30 min; OFF) Test board: <FIG. 1> |
| | Visual | No evidence of mechanical damage. | | |
| Low Temp. Exposure | ΔR | Less than $\pm(3\% \pm 0.1\Omega)$ of the initial value. | 50mΩ Max. | JIS C 5201-1 4.23 Dwell in -55°C chamber without loading for 1,000 ⁺⁴⁸ hours. Stabilize for 60 minutes at room temperature. Measure value. Test board: <FIG. 1> |
| | Visual | No evidence of mechanical damage. | | |
| High Temp. Exposure | ΔR | Less than $\pm(3\% \pm 0.1\Omega)$ of the initial value. | 50mΩ Max. | JIS C 5201-1 4.23 Dwell in 125°C ±2°C or 155°C ±2°C chamber without loading for 1,000 ⁺⁴⁸ hours. Stabilize for 60 minutes at room temperature. Measure value. Test board: <FIG. 1> |
| | Visual | No evidence of mechanical damage. | | |
| Moisture Resistance | ΔR | Less than $\pm(3\% \pm 0.1\Omega)$ of the initial value. | 50mΩ Max. | JIS C 5201-1 4.14 Test Voltage: rated voltage Test temp.: 40±2°C Time: 1,000 ⁺⁴⁸ hours(90 min; ON, 30 min; OFF) Humidity: 90~95% RH Stabilize for 1 hrs & Measure. Test board: <FIG. 1> |
| | Visual | No evidence of mechanical damage. | | |

* These characteristics apply to 1Ω ~10MΩ . In case of other resistance range, please contact us.

* The next is specification in our company for flow soldering and test boards.

Flow soldering Conditions

| Item | Specification | Dipping |
|--------|--------------------|--------------------------------------|
| Flux | ROSIN 25%, IPA 75% | Time: 5~10 sec. |
| Solder | Sn-3.0Ag-0.5Cu | Time: 10 sec max. Temp.: 260±5°C. |

Operation Notes

Example of land Pattern Design

Recommended Soldering Conditions

General Structure

General

Low ohms (RUT Series)

Ultra Low ohms (RU Series)

Ultra Low Ohms (RUK Series)

Ultra Low Ohms (RJ Series)

Arrays (CONVEX Type)

Arrays (CONCAVE Type)

Arrays (FLAT Type)

Anti-Sulfur Resistors

Anti-Sulfur Resistor Arrays(Convex Type)

Anti-Sulfur Resistor Arrays(Concave Type)

Anti-Sulfur Resistor Arrays (Flat Type)

Automotive Anti-sulfur

Automotive Anti-sulfur Arrays (Convex Type)

Attenuator

Characteristics Performance

Packaging

Standard Resistance Value

Taping Type

• Reel dimensions

Unit: mm

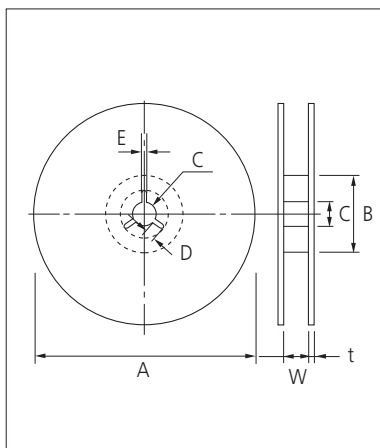

| Symbol | Tape Width | A | B | C | D |
|----------|------------|--------------------------|--------------------------|-------------------------|------------|
| 7" Reel | 8mm | $\varnothing 180+0/-3$ | $\varnothing 60\pm 1.0$ | $\varnothing 13\pm 0.3$ | 4 ± 0.2 |
| | 12mm | $\varnothing 180+0/-3$ | $\varnothing 60\pm 1.0$ | $\varnothing 13\pm 0.3$ | 4 ± 0.2 |
| 10" Reel | 8mm | $\varnothing 258+0/-3$ | $\varnothing 80\pm 1.0$ | $\varnothing 13\pm 0.3$ | 4 ± 0.2 |
| | 12mm | $\varnothing 258+0/-3$ | $\varnothing 80\pm 1.0$ | $\varnothing 13\pm 0.3$ | 4 ± 0.2 |
| 13" Reel | 8mm | $\varnothing 330\pm 2.0$ | $\varnothing 100\pm 1.0$ | $\varnothing 13\pm 0.3$ | 4 ± 0.2 |
| | 12mm | $\varnothing 330\pm 2.0$ | $\varnothing 80\pm 1.0$ | $\varnothing 13\pm 0.3$ | 4 ± 0.2 |

| Symbol | Tape Width | E | W | t |
|----------|------------|--------------|-------------|--------------|
| 7" Reel | 8mm | 2.0 ± 0.5 | 9 ± 0.5 | 1.2 ± 0.2 |
| | 12mm | 2.0 ± 0.5 | 13 ± 0.5 | 1.2 ± 0.2 |
| 10" Reel | 8mm | 2.0 ± 0.5 | 9 ± 0.5 | 1.8 ± 0.2 |
| | 12mm | 2.0 ± 0.5 | 13 ± 0.5 | 1.8 ± 0.2 |
| 13" Reel | 8mm | 3.3 ± 0.5 | 9 ± 0.5 | 2.2 ± 0.2 |
| | 12mm | 3.3 ± 0.5 | 13 ± 0.5 | 2.2 ± 0.2 |

• Tape dimensions

(UNIT: mm)

| Type | Pitch | Carrier Width | Dimensions | | | | | | |
|------------------|------------|---------------|----------------|----------------------------|----------------|--------------------|----------------|----------------|----------------|
| Pressed Paper | 1mm | 8mm | | Type | Size | Size (inch) | A | B | T |
| | | | | RC/RCS/RCM | 0402 | 01005 | 0.24 ± 0.03 | 0.45 ± 0.03 | 0.36 ± 0.02 |
| | | | | | 0603 | 0201 | 0.38 ± 0.05 | 0.68 ± 0.05 | 0.47 ± 0.05 |
| Pressed Paper | 2mm | 8mm | | Type | Size | Size (inch) | A | B | T |
| | | | | RC/RCS/RCM | 0402 | 01005 | 0.24 ± 0.03 | 0.45 ± 0.03 | 0.36 ± 0.02 |
| | | | | | 0603 | 0201 | 0.38 ± 0.05 | 0.68 ± 0.05 | 0.47 ± 0.05 |
| Punched Paper | 2mm | 8mm | | Type | Size | Size (inch) | A | B | T |
| | | | | RC/RCS/RCM /RU/RUT | 1005 | 0402 | 0.65 ± 0.10 | 1.15 ± 0.10 | 0.53 ± 0.07 |
| | | | | RF/RFS/ RM/RMS | 062P | 0302 | 0.70 ± 0.10 | 0.90 ± 0.10 | 0.30 ± 0.05 |
| | | | | | 064P | 0502 | 0.70 ± 0.10 | 1.60 ± 0.10 | 0.30 ± 0.05 |
| | | | | RP/RPS/RPM | 102P | 0404 | 1.17 ± 0.10 | 1.17 ± 0.10 | 0.53 ± 0.07 |
| | | | | | 104P | 0804 | 1.20 ± 0.10 | 2.20 ± 0.10 | 0.53 ± 0.07 |
| | 10AT | 0404 | 1.17 ± 0.10 | 1.71 ± 0.10 | 0.53 ± 0.07 | | | | |
| | 102P | 0404 | 1.20 ± 0.10 | 1.20 ± 0.10 | 0.53 ± 0.07 | | | | |
| | 104P | 0804 | 1.20 ± 0.10 | 2.20 ± 0.10 | 0.70 ± 0.10 | | | | |
| Punched Paper | 4mm | 8mm | | Type | Size | Size (inch) | A | B | T |
| | | | | RC/RCS/RCM /RU/RUT/RUK /RJ | 1608 | 0603 | 1.10 ± 0.10 | 1.90 ± 0.10 | 0.70 ± 0.10 |
| | | | | | 0816 | 0306 | 1.10 ± 0.10 | 1.90 ± 0.10 | 0.70 ± 0.10 |
| | | | | | 2012 | 0805 | 1.65 ± 0.10 | 2.40 ± 0.10 | 0.85 ± 0.10 |
| | | | | | 1220 | 0508 | 1.65 ± 0.10 | 2.40 ± 0.10 | 0.85 ± 0.10 |
| | | | | | 3216 | 1206 | 2.00 ± 0.20 | 3.60 ± 0.20 | 0.85 ± 0.10 |
| | 1632 | 0612 | 2.00 ± 0.20 | 3.60 ± 0.20 | 0.85 ± 0.10 | | | | |
| | 3225 | 1210 | 2.90 ± 0.20 | 3.60 ± 0.20 | 0.85 ± 0.10 | | | | |
| | RC/RPS/RPM | 164P | 1206 | 2.00 ± 0.20 | 3.60 ± 0.20 | 0.85 ± 0.10 | | | |
| Embossed Plastic | 4mm | 12mm | | Type | Size | Size (inch) | A | B | T |
| | | | | RC/RCS/RCM /RU/RUT/RUK /RJ | 2037 | 0815 | 2.30 ± 0.20 | 4.00 ± 0.20 | 1.00 ± 0.10 |
| | | | | | 5025 | 2010 | 2.80 ± 0.20 | 5.30 ± 0.20 | 1.00 ± 0.10 |
| | | | | | 6432 | 2512 | 3.50 ± 0.20 | 6.75 ± 0.20 | 1.00 ± 0.10 |
| | | 3264 | 1225 | 3.50 ± 0.20 | 6.75 ± 0.20 | 1.00 ± 0.10 | | | |

Packaging Table

| TYPE (mm) | TYPE (inch) | Taping Packaging | | | | |
|---------------|----------------|------------------|------|---------------------|----------|-----------|
| | | Code | Reel | Carrier Tape | Quantity | Weight(g) |
| | | CS | 7" | Pressed Paper | 20,000 | 138 |
| 0603 | 0201 | CS | 7" | Pressed Paper | 15,000 | 121 |
| | | DS | 7" | Pressed Paper | 20,000 | 149 |
| | | DP | 7" | Punched PE | 20,000 | 149 |
| | | AS | 13" | Pressed Paper | 60,000 | 573 |
| | | FS | 13" | Pressed Paper | 50,000 | 474 |
| | | FP | 13" | Punched PE | 50,000 | 474 |
| | | WS | 13" | Pressed Paper | 150,000 | 695 |
| 1005 | 0402 | CS | 7" | Punched Paper | 10,000 | 87 |
| | | DS | 7" | | 20,000 | 147 |
| | | DP | 7" | Punched PE | 20,000 | 147 |
| | | ES | 10" | Punched Paper | 30,000 | 331 |
| | | AS | 13" | | 40,000 | 539 |
| | | FS | 13" | | 50,000 | 548 |
| | | 5,000 | 120 | | | |
| 1608 0816* | 0603 0306* | ES | 10" | | 10,000 | 324 |
| | | AS | 13" | | 20,000 | 561 |
| | | | | | 5,000 | 144 |
| 2012 1220* | 0805 0508* | CS | 7" | Punched Paper | 10,000 | 360 |
| | | ES | 10" | | 20,000 | 658 |
| | | AS | 13" | | 5,000 | 152 |
| 3216 1632* | 1206 0612* | CS | 7" | | 10,000 | 382 |
| | | ES | 10" | | 20,000 | 695 |
| | | AS | 13" | | 5,000 | 178 |
| 3225 | 1210 | CS | 7" | | 10,000 | 463 |
| | | ES | 10" | | 20,000 | 674 |
| | | AS | 13" | | 4,000 | 145 |
| 2037* | 0815* | CS | 7" | Embossed Plastic | 4,000 | 197 |
| 5025 | 2010 | CS | 7" | | 4,000 | 262 |
| 6432 3264* | 2512 1225* | CS | 7" | | 4,000 | 1,041 |
| 062P | 0201X2R | CS | 7" | Punched Paper | 15,000 | 126 |
| | | AS | 13" | | 60,000 | 573 |
| 064P | 0201X2R | CS | 7" | | 15,000 | 126 |
| | | AS | 13" | | 60,000 | 573 |
| 102P | 0402X2R | CS | 7" | | 10,000 | 95 |
| | | AS | 13" | | 40,000 | 485 |
| 104P | 0402X4R | CS | 7" | | 10,000 | 131 |
| | | AS | 13" | | 40,000 | 610 |
| 165P | 0603X4R | CS | 7" | | 5,000 | 152 |
| | | AS | 13" | | 20,000 | 695 |
| 10AT | 0404 | CS | 7" | | 10,000 | 95 |
| | | AS | 13" | | 40,000 | 485 |

- General type, Precision, Low ohms, High ohms.
- Packaging style can be modified when you want.
- (*) Wide Terminal Type

Operation
Notes

Example of land
Pattern Design

Recommended
Soldering Conditions

General Structure

General

Low ohms
(RUT Series)

Ultra Low ohms
(RU Series)

Ultra Low Ohms
(RUK Series)

Ultra Low Ohms
(RJ Series)

Arrays
(CONVEX Type)

Arrays
(CONCAVE Type)

Arrays
(FLAT Type)

Anti-Sulfur
Resistors

Anti-Sulfur Resistor
Arrays(Convex Type)

Anti-Sulfur Resistor
Arrays(Concave Type)

Anti-Sulfur Resistor
Arrays (Flat Type)

Automotive
Anti-sulfur

Automotive Anti-sulfur
Arrays (Convex Type)

Attenuator

Characteristics
Performance

Packaging

Standard
Resistance Value

The specifications and designs contained herein may be subject to change without notice.
Please contact our sales representatives or product engineers before order.

Standard Resistance Value

Tolerance Code Table

| Tolerance Code | D | F | G | J | K | M |
|-----------------|---------|------|------|---------|------|------|
| Digit Number | 4 digit | | | 3 digit | | |
| IEC-Code System | E-192 | E-96 | E-48 | E-24 | E-12 | E-6 |
| Specification | ±0.5% | ±1% | ±2% | ±5% | ±10% | ±20% |

Significant Figure of Resistance Value

| E-192 | E-96 | E-48 | E-24 | E-192 | E-96 | E-48 | E-24 | E-192 | E-96 | E-48 | E-24 | E-192 | E-96 | E-48 | E-24 |
|-------|------|------|------|-------|------|------|------|-------|------|------|------|-------|------|------|------|
| 100 | 100 | 100 | 10 | 178 | 178 | 178 | | 316 | 316 | 316 | | 562 | 562 | 562 | 56 |
| 101 | | | | 180 | | | 18 | 320 | | | | 569 | | | |
| 102 | 102 | | | 182 | 182 | | | 324 | 324 | | | 576 | 576 | | |
| 104 | | | | 184 | | | | 328 | | | | 583 | | | |
| 105 | 105 | 105 | | 187 | 187 | 187 | | 332 | 332 | 332 | 33 | 590 | 590 | 590 | |
| 106 | | | | 189 | | | | 336 | | | | 597 | | | |
| 107 | 107 | | | 191 | 191 | | | 340 | 340 | | | 604 | 604 | | |
| 109 | | | | 193 | | | | 344 | | | | 612 | | | |
| 110 | 110 | 110 | 11 | 196 | 196 | 196 | | 348 | 348 | 348 | | 619 | 619 | 619 | |
| 111 | | | | 198 | | | | 352 | | | | 626 | | | 62 |
| 113 | 113 | | | 200 | 200 | | 20 | 357 | 357 | | | 634 | 634 | | |
| 114 | | | | 203 | | | | 361 | | | | 642 | | | |
| 115 | 115 | 115 | | 205 | 205 | 205 | | 365 | 365 | 365 | | 649 | 649 | 649 | |
| 117 | | | | 208 | | | | 370 | | | | 657 | | | |
| 118 | 118 | | | 210 | 210 | | | 374 | 374 | | | 665 | 665 | | |
| 120 | | | 12 | 213 | | | | 379 | | | | 673 | | | |
| 121 | 121 | 121 | | 215 | 215 | 215 | | 383 | 383 | 383 | | 681 | 681 | 681 | 68 |
| 123 | | | | 218 | | | | 388 | | | | 690 | | | |
| 124 | 124 | | | 221 | 221 | | 22 | 392 | 392 | | 39 | 698 | 698 | | |
| 126 | | | | 223 | | | | 397 | | | | 706 | | | |
| 127 | 127 | 127 | | 226 | 226 | 226 | | 402 | 402 | 402 | | 715 | 715 | 715 | |
| 129 | | | | 229 | | | | 407 | | | | 723 | | | |
| 130 | 130 | | 13 | 232 | 232 | | | 412 | 412 | | | 732 | 732 | | |
| 132 | | | | 234 | | | | 417 | | | | 741 | | | |
| 133 | 133 | 133 | | 237 | 237 | 237 | | 422 | 422 | 422 | | 750 | 750 | 750 | 75 |
| 135 | | | | 240 | | | 24 | 427 | | | | 759 | | | |
| 137 | 137 | | | 243 | 243 | | | 432 | 432 | | 43 | 768 | 768 | | |
| 138 | | | | 246 | | | | 437 | | | | 777 | | | |
| 140 | 140 | 140 | | 249 | 249 | 249 | | 442 | 442 | 442 | | 787 | 787 | 787 | |
| 142 | | | | 252 | | | | 448 | | | | 796 | | | |
| 143 | 143 | | | 255 | 255 | | | 453 | 453 | | | 806 | 806 | | |
| 145 | | | | 258 | | | | 459 | | | | 816 | | | |
| 147 | 147 | 147 | | 261 | 261 | 261 | | 464 | 464 | 464 | | 825 | 825 | 825 | 82 |
| 149 | | | | 264 | | | | 470 | | | 47 | 835 | | | |
| 150 | 150 | | 15 | 267 | 267 | | | 475 | 475 | | | 845 | 845 | | |
| 152 | | | | 271 | | | 27 | 481 | | | | 856 | | | |
| 154 | 154 | 154 | | 274 | 274 | 274 | | 487 | 487 | 487 | | 866 | 866 | 866 | |
| 156 | | | | 277 | | | | 493 | | | | 876 | | | |
| 158 | 158 | | | 280 | 280 | | | 499 | 499 | | | 887 | 887 | | |
| 160 | | | 16 | 284 | | | | 505 | | | | 898 | | | |
| 162 | 162 | 162 | | 287 | 287 | 287 | | 511 | 511 | 511 | 51 | 909 | 909 | 909 | |
| 164 | | | | 291 | | | | 517 | | | | 920 | | | 91 |
| 165 | 165 | | | 294 | 294 | | | 523 | 523 | | | 931 | 931 | | |
| 167 | | | | 298 | | | | 530 | | | | 942 | | | |
| 169 | 169 | 169 | | 301 | 301 | 301 | 30 | 536 | 536 | 536 | | 953 | 953 | 953 | |
| 172 | | | | 305 | | | | 542 | | | | 965 | | | |
| 174 | 174 | | | 309 | 309 | | | 549 | 549 | | | 976 | 976 | | |
| 176 | | | | 312 | | | | 556 | | | | 988 | | | |

• Example

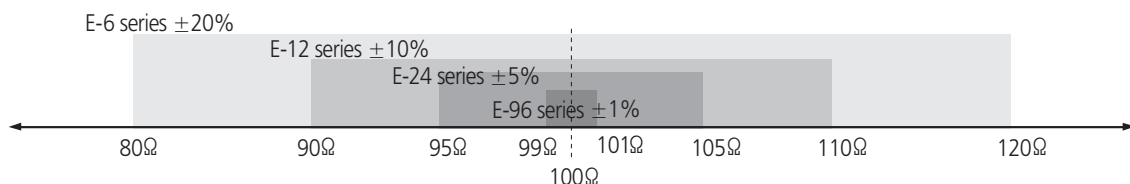

Operation
Notes

Example of land
Pattern Design

Recommended
Soldering Conditions

General Structure

General

Low ohms
(RUT Series)

Ultra Low ohms
(RU Series)

Ultra Low Ohms
(RUK Series)

Ultra Low Ohms
(RJ Series)

Arrays
(CONVEX Type)

Arrays
(CONCAVE Type)

Arrays
(FLAT Type)

Anti-Sulfur
Resistors

Anti-Sulfur Resistor
Arrays(Convex Type)

Anti-Sulfur Resistor
Arrays(Concave Type)

Anti-Sulfur Resistor
Arrays (Flat Type)

Automotive
Anti-sulfur

Automotive Anti-sulfur
Arrays (Convex Type)

Attenuator

Characteristics
Performance

Packaging

**Standard
Resistance Value**

 **Attention**

1. This catalogue is valid only to the products purchased either from us or through our official distributors.
2. Product specifications included in this catalogue are effective as of Dec 1, 2014.
Please be advised that they are standard product specifications for reference only.
We may change, modify or discontinue the product specifications without notice at any time.
So, you need to approve the product specifications before placing an order. Should you have any question regarding our product specifications, please contact our sales personnel or application engineers.
3. We may modify or cease to produce the products listed in this catalogue without notice. Should you have any question, please contact our sales personnel or application engineers.
4. Without obtaining our permission, you should not be allowed to reproduce, copy, use or transfer any content or information contained this catalogue in any manner whatsoever for any purpose.
5. In no event, will we be responsible for any claim, dispute, damage or liability whatsoever arising from, relating to or in connection with your misuse of the products or/and information included in this catalogue.
We will also not assume any responsibilities whatsoever for any claim, dispute, damage or liability with regards to the intellectual property rights or other related rights of ours or any third party associated with your use of our products and/or information contained in this catalogue. We expressly disclaim that no license is granted regarding the aforementioned rights.
6. Please note that the products in this catalogue are not designed or intended to use for the applications set forth below. So, if you intend to use the products in this catalogue for the applications listed below, you should contact our sales personnel or application engineers before using.
Please be aware that any misuse of the products deviating from product specifications or information provided in this catalogue may cause a serious property damage or a personal injury.
 - ① Aerospace/Aviation equipment
 - ② Transportation equipment (vehicles, trains, ships, etc)
 - ③ Medical equipment
 - ④ Military equipment
 - ⑤ Disaster prevention/crime prevention equipment
 - ⑥ Any other applications with the same as or similar complexity or reliability to the applications set forth above.

ISO/TS 16949

ISO 14001

OHSAS 18001

QC080000



Quality System Certification List

Table 1: Certification list of Samsung Factory

| Certification | Section | High Tech(China) |
|----------------|-----------|------------------|
| ISO / TS 16949 | Authority | BSI |
| | Number | TS 91430-008 |
| | Date | 2014 - 11 - 19 |
| | Validity | 2017 - 11 - 18 |
| ISO 14001 | Authority | BSI |
| | Number | EMS 585307 |
| | Date | 2012 - 04 - 17 |
| | Validity | 2015 - 04 - 16 |
| OHSAS 18001 | Authority | BSI |
| | Number | OHS 585308 |
| | Date | 2012 - 04 - 17 |
| | Validity | 2015 - 04 - 16 |
| QC080000 | Authority | UL |
| | Number | PRC-HSPM-1767-1 |
| | Date | 2013 - 07 - 08 |
| | Validity | 2016 - 07 - 26 |



Passive components sales offices

• **Head office**

206, Cheomdansaneop Road,
Yeongtong-gu, Suwon-city,
Gyeonggi province, Korea,
443 - 743

Europe

Tel: + 82 - 31 - 210 - 6328
E-mail:james.pyun@samsung.com

America

Tel: + 82 - 31 - 210 - 6803
E-mail:wesley.rohi@samsung.com

Asia

Tel: + 82 - 31 - 210 - 6791
E-mail:peter_kim@samsung.com

Domestic

Tel: + 82 - 31 - 210 - 5074
E-mail:boungho.leel@samsung.com

• **Manufacturing sites**

Suwon Plant (Korea)

206, Cheomdansaneop Road,
Yeongtong - gu, Suwon-city,
Gyeonggi province, Korea
443 - 743
Tel: + 82 - 31 - 210 - 5074
E-mail:boungho.leel@samsung.com

Busan Plant (Korea)

1623 - 2, Songjeong - dong,
Gangseo - gu, Busan, Korea,
618 - 270
Tel: + 82 - 51 - 970 - 7671
E-mail:kyc.kweoni@samsung.com

Tianjin Plant (China)

27, Heiniucheng - Road, Hexi District,
Tianjin, 300210 China
Tel: +86 - 22 - 2397 - 9000(310)
E-mail:moohantop.Park@samsung.com

High Tech (China)

Xiqing Dist. Micro - Electronics
Industrial Park, Jingang Highway,
Tianjin, China 300385
Tel:+ 86 - 22 - 2397 - 9000(3143)
E-mail:enhao.song@samsung.com

Binhai Plant(China)

80, Xiaqing Road, West area of
BinHai development zone,
TianJin, 300458, China
Tel:+ 86 - 22 - 6686 - 3333(1300)
E-mail:sk1000.kim@samsung.com

Philippines Plant (Philippines)

Block No.5, Calamba Premiere
International Park, Batino, Calamba,
Laguna, Manila, Philippines 4027
Tel: + 63 - 49 - 545 - 0422
E-mail:donna@samsung.com

• **Asia sales offices**

Shenzhen Office

46 F, New World Center,
Yitian Road, Futian District,
Shenzhen, 518026 China
Tel: 86 - 755 - 8608 - 5571
E-mail:jackson.xian@samsung.com

Shanghai Office

Rm. 1211, Shanghai International
Trade Center, No. 2201 Yan an (W) Rd.,
Shanghai, 200335 China
Tel: 86 - 21 - 6270 - 4168(274)
E-mail:dennis.cha@samsung.com

HongKong Office

8/F., Central Plaza, 18 Harbour Road,
Wanchai, Hongkong, China
Tel:852 - 28626344
E-mail:vivianchan@samsung.com

Qingdao Office

Rm 1201, Growne Plaza Qingdao 76,
Xiang Gang Zhong Rd, Qingdao,
266071 China
Tel:86 - 85779102
E-mail:zhengguo.cui@samsung.com

Taiwan Office

9F - 1, Np. 399 Ruey Kuang Rd., Neihu
District, Taipei City, Taiwan, 114
Tel:886 - 2656 - 8356
E-mail:kevin0130.wang@samsung.com

Singapore Office

3 Church Street Samsung Hub,
#23 - 02 Singapore 049483
Tel:65 - 6833 - 3228
E-mail:winson.yeong@samsung.com

Bangkok Office

23rd Floor, Lake Rajada Office Complex
193/89 Rachadapisek Road,
Khet Klongtoey, Bangkok 10110, Thailand
Tel:66 - 2 - 661 - 8004 ~ 5
E-mail:yangshin.yi@samsung.com

• **America sales office**

Irvine Office

3333 Michelson Drive,
Suite 500, Irvine, CA 92612, USA
Tel: 1 - 949 - 797 - 8016
E-mail: andrew.skelly@samsung.com

• **Europe sales offices**

Frankfurt Office

Samsung Haus, Am Kronberger Hang 6,
D-65824 Schwalbach/Ts. Germany
Tel: 49 - 6196 - 66 - 7255
E-mail:frank.goebel@samsung.com

Hungary Office

H-2310, Leshegy utca 2-4,
Szigetszentmiklos, Pest megye, Hungary
Tel: 36 - 24 - 551 - 148
E-mail:jun21c.leel@samsung.com

• **Domestic Distributors**

Korchip Corporation

817 - 38, Anyang 2 - dong, Manan - gu,
Anyang-city, Gyeonggi province,
Korea, 430-812
Tel: + 82 - 31 - 361 - 8100
E-mail:itasapi@korchip.com

SAMT

Daekyung Bldg., 983 - 10, Daechi - dong,
Gangnam - gu, Seoul, Korea
Tel: + 82 - 2 - 3458 - 9000
E-mail:info@isamt.com

CHUNGMAC

301 Gwonseon Medivill, 544-14
Gokbanjeong-dong, Gwonseon-gu,
Suwon-si, Gyeonggi-do Korea
Tel: + 82 - 31 - 234 - 2367~8
E-mail:webmaster@chungmac.co.kr

YOUNGDUK

Gasan-Dong 632, Seobusaetgil,
Geumcheon-Gu, Seoul, Korea
Tel: + 82 - 2 - 2107 - 7860
E-mail:siyang1109@gmail.com