

PNP SURFACE MOUNT SMALL SIGNAL TRANSISTOR IN SOT23

Features

- Ideally Suited for Automatic Insertion
- Complementary NPN Types Available (BC846 – BC848)
- For switching and AF Amplifier Applications
- **Totally Lead-Free & Fully RoHS compliant (Notes 1 & 2)**
- **Halogen and Antimony Free. "Green" Device (Note 3)**
- **Qualified to AEC-Q101 Standards for High Reliability**
- **PPAP capable (Note 4)**

Mechanical Data

- Case: SOT23
- Case material: molded plastic, "Green" molding compound
- UL Flammability Classification Rating 94V-0
- Moisture Sensitivity: Level 1 per J-STD-020
- Terminals: Finish – Matte Tin Plated Leads, Solderable per MIL-STD-202, Method 208 
- Weight: 0.008 grams (Approximate)



Top View

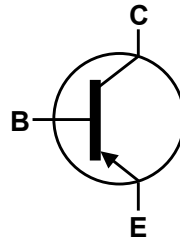

Device Symbol

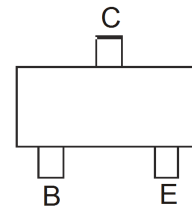

Top View
Pin-Out

Ordering Information (Notes 4 & 5)

Product	Compliance	Marking	Reel size (inches)	Quantity per reel
BC856A-7-F	AEC-Q101	K3A	7	3,000
BC856B-7-F	AEC-Q101	K3B	7	3,000
BC856BQ-7-F	Automotive	K3B	7	3,000
BC856B-13-F	AEC-Q101	K3B	13	10,000
BC856BQ-13-F	Automotive	K3B	13	10,000
BC857A-7-F	AEC-Q101	K3A	7	3,000
BC857B-7-F	AEC-Q101	K3B	7	3,000
BC857BQ-7-F	Automotive	K3B	7	3,000
BC857B-13-F	AEC-Q101	K3B	13	10,000

Product	Compliance	Marking	Reel size (inches)	Quantity per reel
BC857C-7-F	AEC-Q101	K3G	7	3,000
BC857C-13-F	AEC-Q101	K3G	13	10,000
BC858A-7-F	AEC-Q101	K3A	7	3,000
BC858B-7-F	AEC-Q101	K3B	7	3,000
BC858C-7-F	AEC-Q101	K3G	7	3,000

- Notes:
1. No purposely added lead. Fully EU Directive 2002/95/EC (RoHS) & 2011/65/EU (RoHS 2) compliant.
 2. See http://www.diodes.com/quality/lead_free.html for more information about Diodes Incorporated's definitions of Halogen and Antimony free, "Green" and Lead-Free.
 3. Halogen and Antimony free "Green" products are defined as those which contain <900ppm bromine, <900ppm chlorine (<1500ppm total Br + Cl) and <1000ppm antimony compounds.
 4. Automotive products are AEC-Q101 qualified and are PPAP capable. Automotive, AEC-Q101 and standard products are electrically and thermally the same, except where specified. For more information, please refer to http://www.diodes.com/quality/product_compliance_definitions/.
 5. Tape width is 8mm. For packaging details, go to our website at <http://www.diodes.com/products/packages.html>

Marking Information

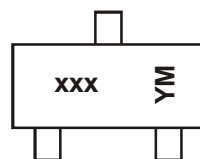

xxx = Product Type Marking Code
(Please see Ordering Information)
YM = Date Code Marking
Y = Year ex: X = 2010
M = Month ex: 9 = September

Date Code Key

Year	2010	2011	2012	2013	2014	2015	2016	2017
Code	X	Y	Z	A	B	C	D	E

Month	Jan	Feb	Mar	Apr	May	Jun	Jul	Aug	Sep	Oct	Nov	Dec
Code	1	2	3	4	5	6	7	8	9	O	N	D

Maximum Ratings (@T_A = +25°C, unless otherwise specified.)

Characteristic		Symbol	Value	Unit
Collector-Base Voltage	BC856	V _{CB0}	-80	V
	BC857		-50	
	BC858		-30	
Collector-Emitter Voltage	BC856	V _{CEO}	-65	V
	BC857		-45	
	BC858		-30	
Emitter-Base Voltage		V _{EBO}	-5.0	V
Continuous Collector Current		I _C	-100	mA
Peak Collector Current		I _{CM}	-200	mA
Peak Emitter Current		I _{EM}	-200	mA

Thermal Characteristics (@T_A = +25°C, unless otherwise specified.)

Characteristic		Symbol	Value	Unit
Power Dissipation	(Note 6)	P _D	310	mW
	(Note 7)		350	
Thermal Resistance, Junction to Ambient	(Note 6)	R _{θJA}	403	°C/W
	(Note 7)		357	
Thermal Resistance, Junction to Leads	(Note 8)	R _{θJL}	350	°C/W
Operating and Storage Temperature Range		T _J , T _{STG}	-65 to +150	°C

ESD Ratings (Note 9)

Characteristic	Symbol	Value	Unit	JEDEC Class
Electrostatic Discharge - Human Body Model	ESD HBM	≥ 8,000	V	3B
Electrostatic Discharge - Machine Model	ESD MM	≥ 400	V	C

- Notes:
6. For the device mounted on minimum recommended pad layout FR4 PCB with high coverage of single sided 1oz copper, in still air conditions.
 7. For the device mounted on 15mm x 15mm x 1.6mm FR4 PCB with high coverage of single sided 1oz copper, in still air conditions.
 8. Thermal resistance from junction to solder-point (at the end of the leads).
 9. Refer to JEDEC specification JESD22-A114 and JESD22-A115.

Thermal Characteristics and Derating Information



Derating Curve

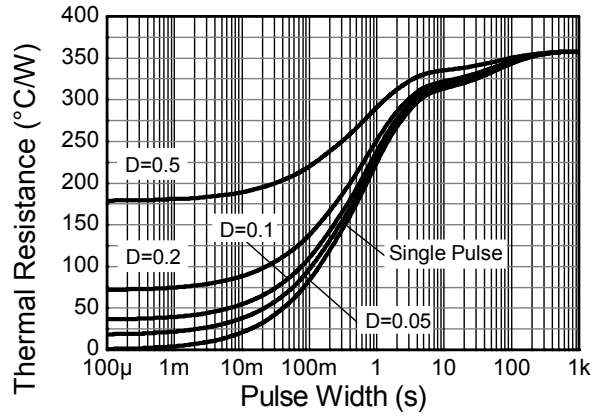

Transient Thermal Impedance



Pulse Power Dissipation

Electrical Characteristics (@T_A = +25°C, unless otherwise specified.)

Characteristic		Symbol	Min	Typ	Max	Unit	Test Condition
Collector-Base Breakdown Voltage	BC856	BV _{CBO}	-80	—	—	V	I _C = -10μA
	BC857		-50				
	BC858		-30				
Collector-Emitter Breakdown Voltage (Note 10)	BC856	BV _{CEO}	-65	—	—	V	I _C = -10mA
	BC857		-45				
	BC858		-30				
Emitter-Base Breakdown Voltage		BV _{EBO}	-5	—	—	V	I _E = -1μA
Collector Cutoff Current		I _{CBO}	—	—	-15 -4	μA	V _{CB} = -30V V _{CB} = -30V, T _A = +150°C
Collector Emitter Cutoff Current	BC856	I _{CES}	—	—	-15	nA	V _{CE} = -80V V _{CE} = -50V V _{CE} = -30V
	BC857				-15		
	BC858				-15		
Small Signal Current Gain (Note 10)	BC856A / BC857A / BC858A	h _{re}	—	—	200	—	I _C = -2.0mA, V _{CE} = -5V f = 1.0kHz
	BC856B / BC857B / BC858B				330		
	BC857C / BC858C				600		
Input Impedance (Note 10)	BC856A / BC857A / BC858A	h _{ie}	—	—	2.7	kΩ	
	BC856B / BC857B / BC858B				4.5		
	BC857C / BC858C				8.7		
Output Admittance (Note 10)	BC856A / BC857A / BC858A	h _{oe}	—	—	18	μS	
	BC856B / BC857B / BC858B				30		
	BC857C / BC858C				60		
Reverse Voltage Transfer Ratio (Note 10)	BC856A / BC857A / BC858A	h _{re}	—	—	1.5x10 ⁻⁴	—	
	BC856B / BC857B / BC858B				2x10 ⁻⁴		
	BC857C / BC858C				3x10 ⁻⁴		
DC Current Gain (Note 10)	BC856A / BC857A / BC858A	h _{FE}	—	—	125	—	I _C = -2.0mA, V _{CE} = -5V
	BC856B / BC857B / BC858B				220		
	BC857C / BC858C				420		
Collector-Emitter Saturation Voltage (Note 10)		V _{CE(sat)}	—	—	-75 -250 -300	mV	I _C = -10mA, I _B = -0.5mA I _C = -100mA, I _B = -5.0mA
Base-Emitter Turn-On Voltage (Note 10)		V _{BE(on)}	-600	-650	-750 -820	mV	I _C = -2mA, V _{CE} = -5V I _C = -10mA, V _{CE} = -5V
Base-Emitter Saturation Voltage (Note 10)		V _{BE(sat)}	—	—	-700 -850	mV	I _C = -10mA, I _B = -0.5mA I _C = -100mA, I _B = -5mA
Output Capacitance		C _{obo}	—	3	—	pF	V _{CB} = -10V, f = 1.0MHz
Transition Frequency		f _T	100	200	—	MHz	V _{CE} = -5V, I _C = -10mA, f = 100MHz
Noise Figure		NF	—	2	10	dB	V _{CE} = -5V, I _C = -200μA R _S = 2kΩ, f = 1kHz Δf = 200Hz

Notes: 10. Measured under pulsed conditions. Pulse width ≤ 300μs. Duty cycle ≤ 2%

Typical Electrical Characteristics (@ $T_A = +25^\circ\text{C}$, unless otherwise specified.)



Figure 1 Typical DC Current Gain vs. Collector Current



Figure 2 Typical Collector-Emitter Saturation Voltage vs. Collector Current

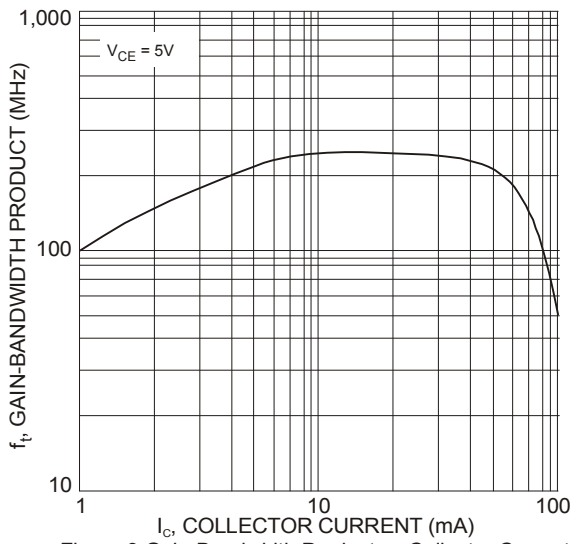
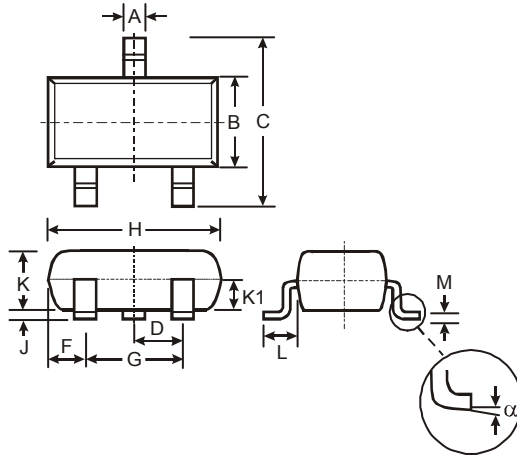

Figure 3 Gain-Bandwidth Product vs Collector Current

Package Outline Dimensions

Please see AP02002 at <http://www.diodes.com/datasheets/ap02002.pdf> for latest version.



SOT23			
Dim	Min	Max	Typ
A	0.37	0.51	0.40
B	1.20	1.40	1.30
C	2.30	2.50	2.40
D	0.89	1.03	0.915
F	0.45	0.60	0.535
G	1.78	2.05	1.83
H	2.80	3.00	2.90
J	0.013	0.10	0.05
K	0.903	1.10	1.00
K1	-	-	0.400
L	0.45	0.61	0.55
M	0.085	0.18	0.11
α	0°	8°	-
All Dimensions in mm			

Suggested Pad Layout

Please see AP02001 at <http://www.diodes.com/datasheets/ap02001.pdf> for the latest version.



Dimensions	Value (in mm)
Z	2.9
X	0.8
Y	0.9
C	2.0
E	1.35

IMPORTANT NOTICE

DIODES INCORPORATED MAKES NO WARRANTY OF ANY KIND, EXPRESS OR IMPLIED, WITH REGARDS TO THIS DOCUMENT, INCLUDING, BUT NOT LIMITED TO, THE IMPLIED WARRANTIES OF MERCHANTABILITY AND FITNESS FOR A PARTICULAR PURPOSE (AND THEIR EQUIVALENTS UNDER THE LAWS OF ANY JURISDICTION).

Diodes Incorporated and its subsidiaries reserve the right to make modifications, enhancements, improvements, corrections or other changes without further notice to this document and any product described herein. Diodes Incorporated does not assume any liability arising out of the application or use of this document or any product described herein; neither does Diodes Incorporated convey any license under its patent or trademark rights, nor the rights of others. Any Customer or user of this document or products described herein in such applications shall assume all risks of such use and will agree to hold Diodes Incorporated and all the companies whose products are represented on Diodes Incorporated website, harmless against all damages.

Diodes Incorporated does not warrant or accept any liability whatsoever in respect of any products purchased through unauthorized sales channel. Should Customers purchase or use Diodes Incorporated products for any unintended or unauthorized application, Customers shall indemnify and hold Diodes Incorporated and its representatives harmless against all claims, damages, expenses, and attorney fees arising out of, directly or indirectly, any claim of personal injury or death associated with such unintended or unauthorized application.

Products described herein may be covered by one or more United States, international or foreign patents pending. Product names and markings noted herein may also be covered by one or more United States, international or foreign trademarks.

This document is written in English but may be translated into multiple languages for reference. Only the English version of this document is the final and determinative format released by Diodes Incorporated.

LIFE SUPPORT

Diodes Incorporated products are specifically not authorized for use as critical components in life support devices or systems without the express written approval of the Chief Executive Officer of Diodes Incorporated. As used herein:

A. Life support devices or systems are devices or systems which:

1. are intended to implant into the body, or
2. support or sustain life and whose failure to perform when properly used in accordance with instructions for use provided in the labeling can be reasonably expected to result in significant injury to the user.

B. A critical component is any component in a life support device or system whose failure to perform can be reasonably expected to cause the failure of the life support device or to affect its safety or effectiveness.

Customers represent that they have all necessary expertise in the safety and regulatory ramifications of their life support devices or systems, and acknowledge and agree that they are solely responsible for all legal, regulatory and safety-related requirements concerning their products and any use of Diodes Incorporated products in such safety-critical, life support devices or systems, notwithstanding any devices- or systems-related information or support that may be provided by Diodes Incorporated. Further, Customers must fully indemnify Diodes Incorporated and its representatives against any damages arising out of the use of Diodes Incorporated products in such safety-critical, life support devices or systems.

Copyright © 2013, Diodes Incorporated

www.diodes.com