

Coil type EMI Filters (Digital Noise Filters)

Type: **ELKE**□



■ Features

- 3218 case size, 6 A rated current (ELKEA) and 2 A rated current (ELKE).
- High ESD suppression with varistor and included coils.
- No variation in attenuation characteristics as current changes.
- The stable P/N marking using laser technology makes the part number check easier.
- RoHS compliant

■ Recommended Applications

- Data lines, secondary power supply lines (DC lines) for game, digital AV and communications equipment.

■ Explanation of Part Numbers

[ELKE, ELKEA Series]

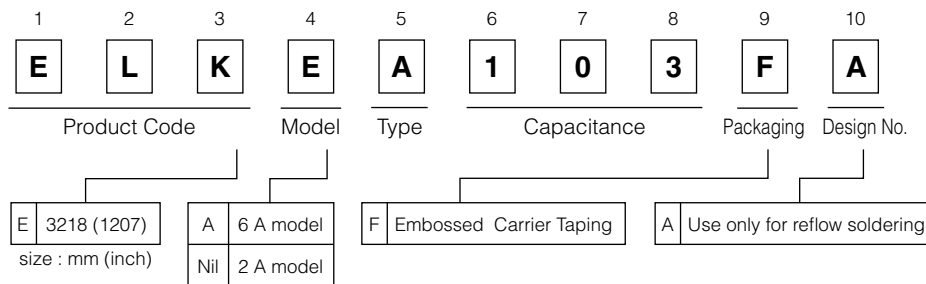

[ELKEV Series]

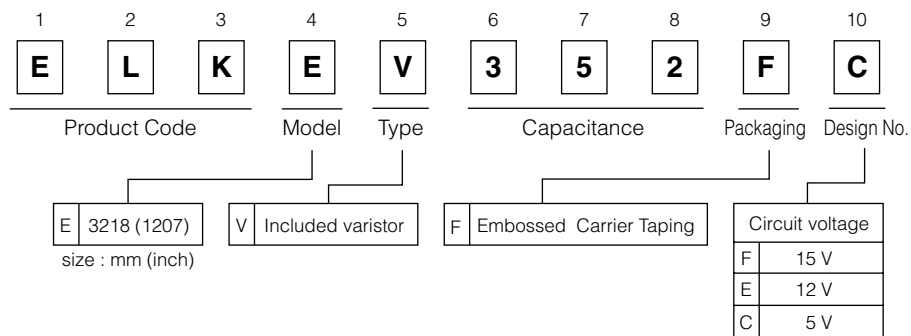

■ Construction

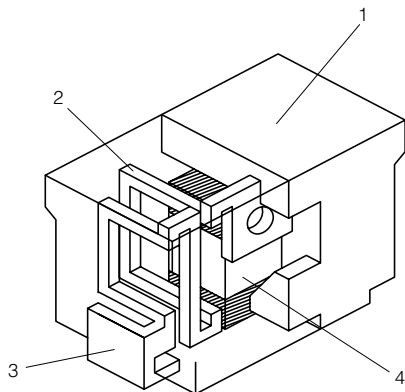

No.	Part Name	Material
1	Enclosure	PPS resin mixed with ferrite powder
2	Coil	Copper alloy plate
3	Terminal	Copper alloy plate with SnCu
4	Capacitor	Chip capacitor

■ Dimensions in mm (not to scale)

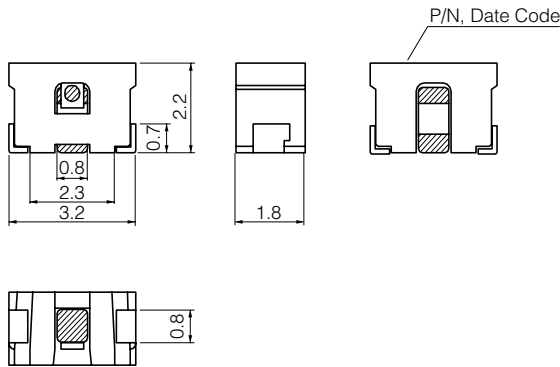

■ Land Pattern in mm (not to scale)

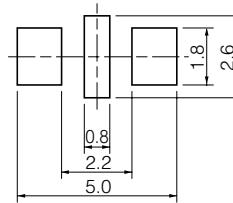

■ Packaging state

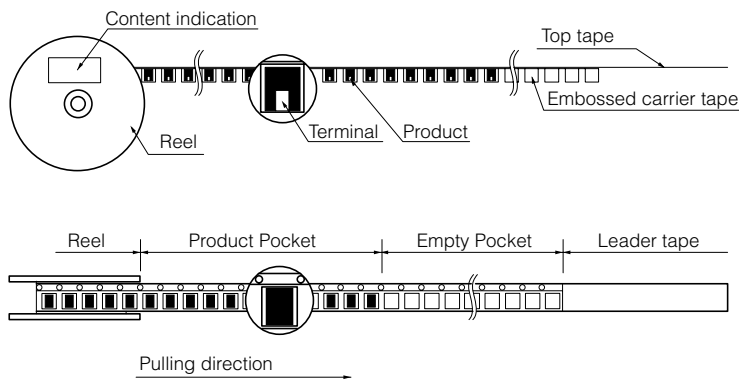

Reel Size : $\phi 178$
 Q'ty : 2000 pcs./Reel
 Packaging : Embossed Carrier Taping

■ Soldering conditions for reflow

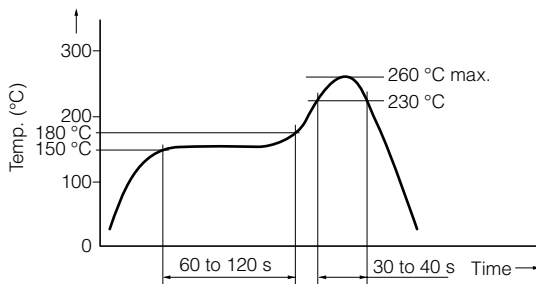

■ Storage Conditions

- Package : Normal temperature (-5 to 35 °C), normal humidity (85 %RH max.), shall not be exposed to direct sunlight and harmful gases and care should be taken so as not to cause dew.
- Operating Temperature : -20 to +85 °C

■ Storage Period

- Solderability may be reduced due to the conditions of high temperature and high humidity which causes the oxidation of tin-plated terminals. Even if storage conditions are within specified limits, solderability may be reduced with the passage of time. Therefore, please control the storage conditions and try to use the product within 6 months of receipt.

Design and specifications are each subject to change without notice. Ask factory for the current technical specifications before purchase and/or use. Should a safety concern arise regarding this product, please be sure to contact us immediately.

Large Current Coil type EMI Filters (Digital Noise Filters) SMD

Type: **ELKEA**



■ Features

- 3218 case size, 6 A rated current.
- No variation in attenuation characteristics as current changes.
- The stable P/N marking using laser technology makes the part number check easier.
- RoHS compliant

■ Typical Specification

- Operating temperature : -20 to +85 °C
- Rated Voltage : DC 50 V (Except ELKEA333FA : DC25 V)
- Rated Current : DC 6 A

■ Standard Parts

Part No.	Cut off frequency (MHz)	Inner Capacitance (pF typ.)	Rated Voltage (V)	Rated Current (A)	Indication		min. Packaging unit (pcs.)	
					Indication 1	Indication 2		
ELKEA100FA	500	10	50	6.0	100□	Indication 2	2000	
ELKEA220FA	300	22			220□			
ELKEA470FA	150	47			470□			
ELKEA101FA	70	100			101□			
ELKEA221FA	30	220			221□			
ELKEA471FA	15	470			471□			
ELKEA102FA	7	1000			102□			
ELKEA222FA	3	2200			222□			
ELKEA103FA	0.5/DC	10000			103□			Indication 1
ELKEA333FA	0.2/DC	33000			25			333□

note1 : 4th letter (□) of marking indicates the Month Code.
note2 : Indication 1, 2 refer to Indication examples.

■ Performance characteristics (Reference)

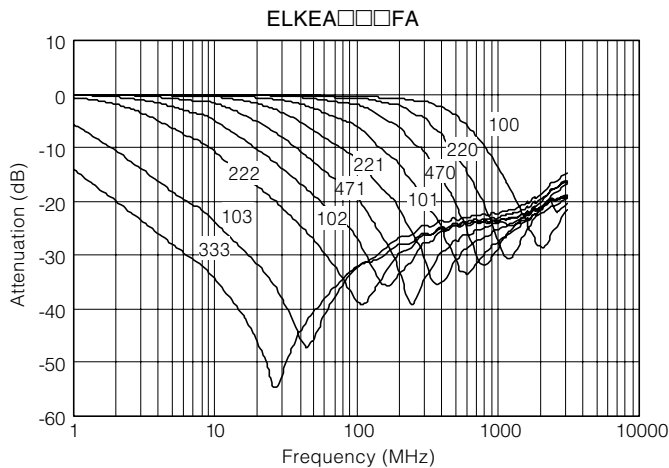

■ Equivalent circuit, measurement block diagram

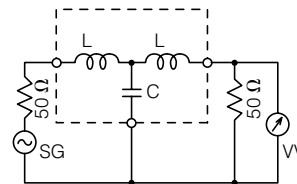

■ Indication Examples

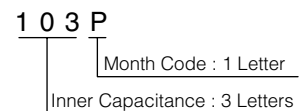
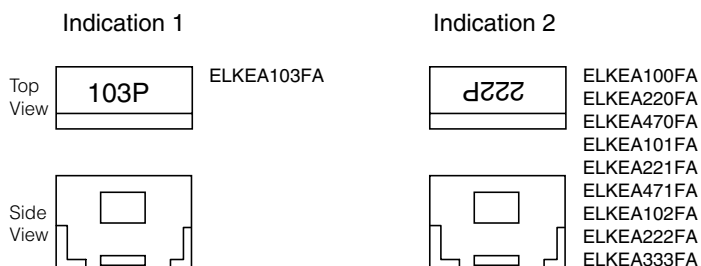

Coil type EMI Filters (Digital Noise Filters) SMD

Type: **ELKE**



■ Features

- 3218 case size, 2 A rated current.
- No variation in attenuation characteristics as current changes.
- The stable P/N marking using laser technology makes the part number check easier.
- RoHS compliant

■ Typical Specification

- Operating temperature : -20 to +85 °C
- Rated Voltage : DC 50 V (Except ELKE333FA : DC25 V)
- Rated Current : DC 2 A

■ Standard Parts

Part No.	Cut off frequency (MHz)	Inner Capacitance (pF typ.)	Rated Voltage (V)	Rated Current (A)	Indication	min. Packaging unit (pcs.)
ELKE100FA	250	10	50	2.0	100□	2000
ELKE220FA	200	22			220□	
ELKE470FA	100	47			470□	
ELKE101FA	50	100			101□	
ELKE221FA	25	220			221□	
ELKE471FA	10	470			471□	
ELKE102FA	5	1000			102□	
ELKE222FA	2	2200			222□	
ELKE103FA	0.5/DC	10000			103□	
ELKE333FA	0.2/DC	33000	25	333□		

note1 : 4th letter (□) of marking indicates the Month Code.

■ Performance characteristics (Reference)

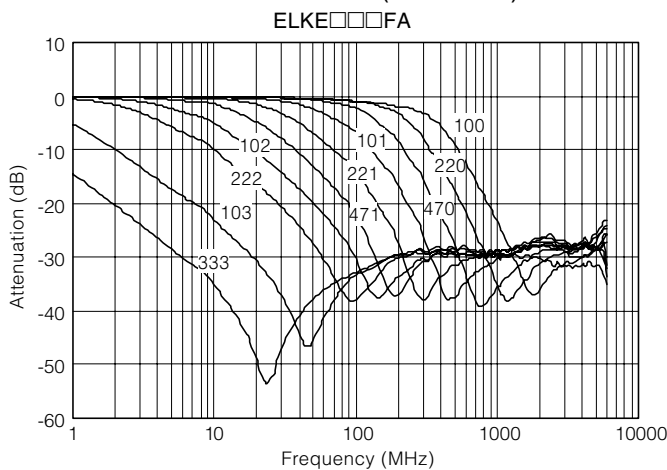

■ Equivalent circuit, measurement block diagram

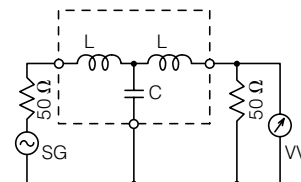

■ Indication Examples

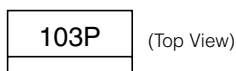

1 0 3 P
 Month Code : 1 Letter
 Inner Capacitance : 3 Letters

Varistor included Coil type EMI Filters (Digital Noise Filters)

SMD

Type: **ELKEV**



■ Features

- High ESD suppression with varistor and included coils.
- No variation in attenuation characteristics as current changes.
- The stable P/N marking using laser technology makes the part number check easier.
- RoHS compliant

■ Typical Specification

- Operating temperature : -20 to +85 °C
- Rated Voltage : Applicable normal voltage for varistor
- Rated Current : DC 2 A

■ Standard Parts

Part No.	Cut off frequency (MHz)	Inner Capacitance (pF typ.)	Rated Voltage (V)	Applicable circuit voltage (V max.)	Indication		min. Packaging unit (pcs.)
					2.0		
ELKEV150FF	250	15	27	15	2.0	150□	2000
ELKEV300FF	200	30	27	15		300□	
ELKEV161FF	50	160	27	15		161□	
ELKEV431FF	20	430	27	15		431□	
ELKEV561FE	10	560	22	12		561□	
ELKEV112FC	8	1050	12	5		112□	
ELKEV352FC	1/DC	3500	12	5		352□	

Note1 : 4th letter (□) of marking indicates the Month Code.

■ Performance characteristics (Reference)

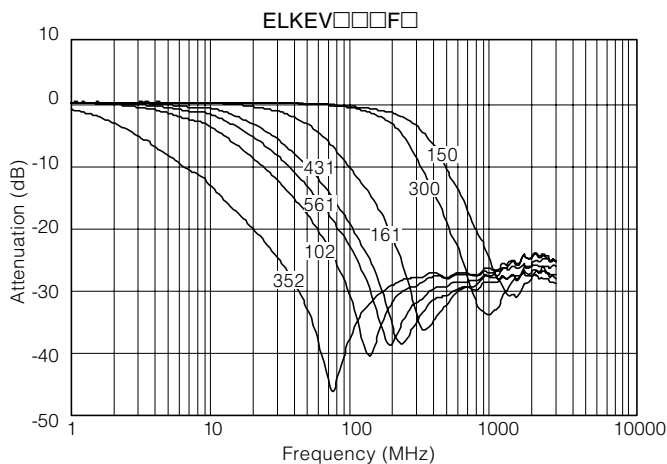

■ Equivalent circuit, measurement block diagram

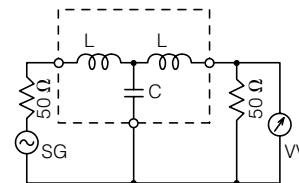

■ Indication Examples

352P

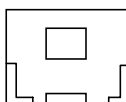

3 5 2 P

Month Code : 1 Letter

Inner Capacitance : 3 Letters

Design and specifications are each subject to change without notice. Ask factory for the current technical specifications before purchase and/or use. Should a safety concern arise regarding this product, please be sure to contact us immediately.

Safety Precautions

The following are precautions for individual products. Please also refer to the common precautions for Noise Suppression Device shown on this catalog.

1. Operation range and environments

- ① These products are designed and manufactured for general and standard use in general electronic equipment (e.g. AV equipment, home electric appliances, office equipment, information and communication equipment)
- ② These products are not intended for use in the following special conditions. Before using the products, carefully check the effects on their quality and performance, and determine whether or not they can be used.
 - In liquid, such as water, oil, chemicals, or organic solvent
 - In direct sunlight, outdoors, or in dust
 - In salty air or air with a high concentration of corrosive gas, such as Cl₂, H₂S, NH₃, SO₂, or NO₂
 - In an environment where these products cause dew condensation

2. Handling

- ① Do not bring magnets or magnetized materials close to the product. The influence of their magnetic field can change the inductance value.
- ② Do not apply strong mechanical shocks by either dropping or collision with other parts. Excessive shock can damage the part.

3. Land pattern design

- ① Please refer to the recommended land pattern for each type shown on the datasheet.
- ② In case of reflow soldering, consider the layout because taller components close to EMI filters tend to block thermal conduction.

4. Mounting

- ① Avoid excessive placement force.
- ② Do not bend or twist the PWB after mounting the part.

5. Cleaning

- ① Do not use acid or alkali agents. Some cleaning solvents may damage the part. Confirm by testing the reliability in advance of mass production.
- ② If Ultrasonic cleaning is used, please confirm the reliability in advance. It is possible that combined resonance of component and PWB and cavitation can cause an abnormal vibration mode to exist causing damage.