

Integrated Silicon Pressure Sensor Manifold Absolute Pressure Sensor On-Chip Signal Conditioned, Temperature Compensated and Calibrated

The MPX4250A series Manifold Absolute Pressure (MAP) sensor for engine control is designed to sense absolute air pressure within the intake manifold. This measurement can be used to compute the amount of fuel required for each cylinder.

The MPX4250A series piezoresistive transducer is a state-of-the-art monolithic silicon pressure sensor designed for a wide range of applications, particularly those employing a microcontroller or microprocessor with A/D inputs. This transducer combines advanced micromachining techniques, thin-film metallization and bipolar processing to provide an accurate, high-level analog output signal that is proportional to the applied pressure. The small form factor and high reliability of on-chip integration make the Freescale sensor a logical and economical choice for the automotive system engineer.

Features

- 1.5% Maximum Error Over 0° to 85°C
- Specifically Designed for Intake Manifold Absolute Pressure Sensing in Engine Control Systems
- Patented Silicon Shear Stress Strain Gauge
- Temperature Compensated Over -40° to +125°C
- Offers Reduction in Weight and Volume Compared to Existing Hybrid Modules
- Durable Epoxy Unibody Element or Thermoplastic Small Outline, Surface Mount Package
- Ideal for Non-Automotive Applications

MPX4250A Series

20 to 250 kPa (2.9 to 36.3 psi)
0.2 to 4.9 V Output

Application Examples

- Turbo Boost Engine Control
- Ideally Suited for Microprocessor or Microcontroller-Based Systems

ORDERING INFORMATION

Device Name	Package Options	Case No.	# of Ports			Pressure Type			Device Marking
			None	Single	Dual	Gauge	Differential	Absolute	
Small Outline Package (MPXA4250A Series)									
MPXA4250A6U	Rail	482	•					•	MPXA4250A
MPXA4250AC6U	Rail	482A		•				•	MPXA4250A
MPXA4250AC6T1	Tape and Reel	482A		•				•	MPXA4250A
Unibody Package (MPX4250A Series)									
MPX4250A	Tray	867	•					•	MPX4250A
MPX4250AP	Tray	867B		•				•	MPX4250A

SMALL OUTLINE PACKAGES

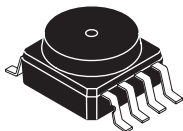

MPXA4250A6U
CASE 482-01

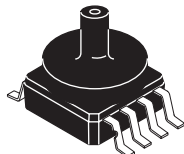

MPXA4250AC6U/C6T1
CASE 482A-01

UNIBODY PACKAGES

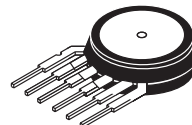

MPX4250A
CASE 867-08

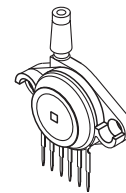

MPX4250AP
CASE 867B-04

Operating Characteristics

Table 1. Operating Characteristics ($V_S = 5.1 V_{DC}$, $T_A = 25^\circ C$ unless otherwise noted, $P_1 > P_2$, Decoupling circuit shown in Figure 3 required to meet electrical specifications.)

Characteristic	Symbol	Min	Typ	Max	Units
Differential Pressure Range ⁽¹⁾	P_{OP}	20	—	250	kPa
Supply Voltage ⁽²⁾	V_S	4.85	5.1	5.35	V_{DC}
Supply Current	I_O	—	7.0	10	mAdc
Minimum Pressure Offset ⁽³⁾ @ $V_S = 5.1$ Volts	V_{OFF}	0.133	0.204	0.274	V_{DC}
Full Scale Output ⁽⁴⁾ @ $V_S = 5.1$ Volts	V_{FSO}	4.826	4.896	4.966	V_{DC}
Full Scale Span ⁽⁵⁾ @ $V_S = 5.1$ Volts	V_{FSS}	—	4.692	—	V_{DC}
Accuracy ⁽⁶⁾	—	—	—	± 1.5	% V_{FSS}
Sensitivity	$\Delta V/\Delta P$	—	20	—	mV/kPa
Response Time ⁽⁷⁾	t_R	—	1.0	—	msec
Output Source Current at Full Scale Output	I_{O+}	—	0.1	—	mAdc
Warm-Up Time ⁽⁸⁾	—	—	20	—	msec
Offset Stability ⁽⁹⁾	—	—	± 0.5	—	% V_{FSS}

- 1.0 kPa (kiloPascal) equals 0.145 psi.
- Device is ratiometric within this specified excitation range.
- Offset (V_{OFF}) is defined as the output voltage at the minimum rated pressure.
- Full Scale Output (V_{FSO}) is defined as the output voltage at the maximum or full rated pressure.
- Full Scale Span (V_{FSS}) is defined as the algebraic difference between the output voltage at full rated pressure and the output voltage at the minimum rated pressure.
- Accuracy (error budget) consists of the following:
 - Linearity: Output deviation at any temperature from a straight line relationship with pressure over the specified pressure range.
 - Temperature Hysteresis: Output deviation at any temperature within the operating temperature range, after the temperature is cycled to and from the minimum or maximum operating temperature points, with zero differential pressure applied.
 - Pressure Hysteresis: Output deviation at any pressure within the specified range, when this pressure is cycled to and from the minimum or maximum rated pressure, at $25^\circ C$.
 - TcSpan: Output deviation over the temperature range of 0° to $85^\circ C$, relative to $25^\circ C$.
 - TcOffset: Output deviation with minimum rated pressure applied, over the temperature range of 0° to $85^\circ C$, relative to $25^\circ C$.
 - Variation from Nominal: The variation from nominal values, for Offset or Full Scale Span, as a percent of V_{FSS} , at $25^\circ C$.
- Response Time is defined as the time from the incremental change in the output to go from 10% to 90% of its final value when subjected to a specified step change in pressure.
- Warm-up Time is defined as the time required for the product to meet the specified output voltage after the pressure is stabilized.
- Offset stability is the product's output deviation when subjected to 1000 hours of Pulsed Pressure, Temperature Cycling with Bias Test.

Maximum Ratings

Table 2. Maximum Ratings⁽¹⁾

Rating	Symbol	Value	Unit
Maximum Pressure ⁽²⁾ (P1 > P2)	P_{MAX}	1000	kPa
Storage Temperature	T_{STG}	-40 to +125	°C
Operating Temperature	T_A	-40 to +125	°C

1. TC = 25°C unless otherwise noted.
2. Exposure beyond the specified limits may cause permanent damage or degradation to the device.

Figure 1 shows a block diagram of the internal circuitry integrated on a pressure sensor chip.

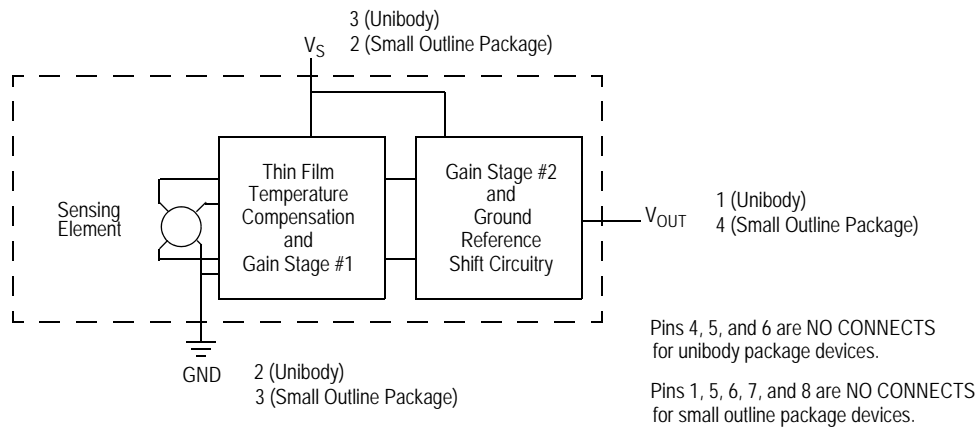

Figure 1. Fully Integrated Pressure Sensor Schematic for Unibody Package and Small Outline Package

On-chip Temperature Compensation and Calibration

Figure 2 illustrates the absolute pressure sensing chip in the basic chip carrier (Case 867). A fluorosilicone gel isolates the die surface and wire bonds from the environment, while allowing the pressure signal to be transmitted to the sensor diaphragm.

The MPX4250A series pressure sensor operating characteristics and internal reliability and qualification tests are based on use of dry air as the pressure media. Media, other than dry air, may have adverse effects on sensor performance and long-term reliability.

Contact the factory for information regarding media compatibility in your application.

Figure 3 shows the recommended decoupling circuit for interfacing the output of the integrated sensor to the A/D input of a microprocessor or microcontroller.

Figure 4 shows the sensor output signal relative to pressure input. Typical, minimum, and maximum output curves are shown for operation over temperature range of 0° to 85°C using the decoupling circuit shown in Figure 3. The output will saturate outside of the specified pressure range.

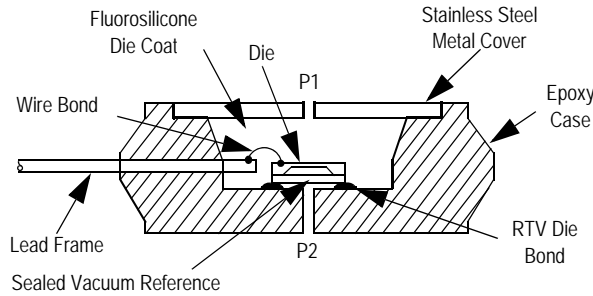

Figure 2. Cross Sectional Diagram (not to scale)

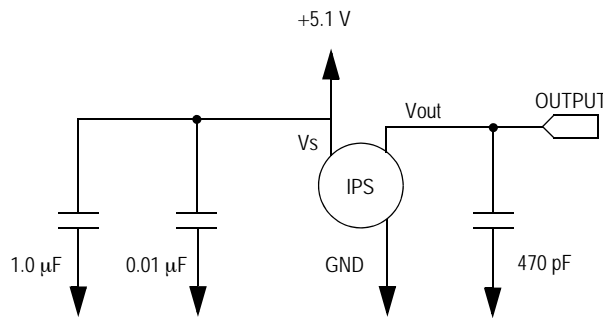

Figure 3. Recommended Power Supply Decoupling and Output Filtering (For additional output filtering, please refer to Application Note AN1646)

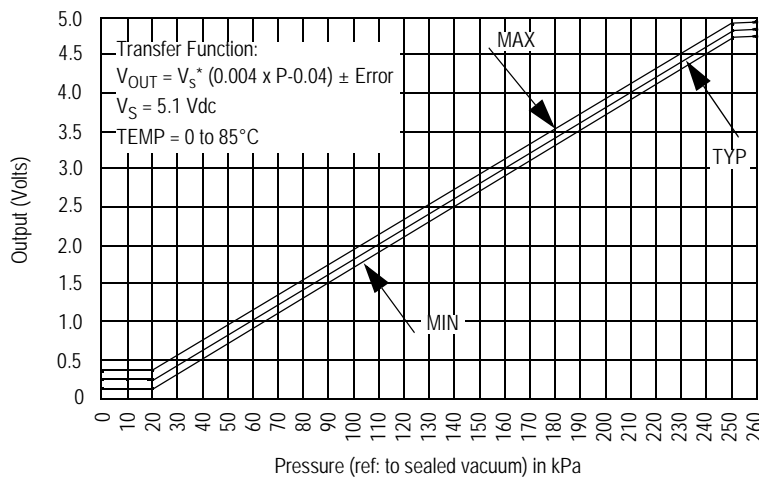
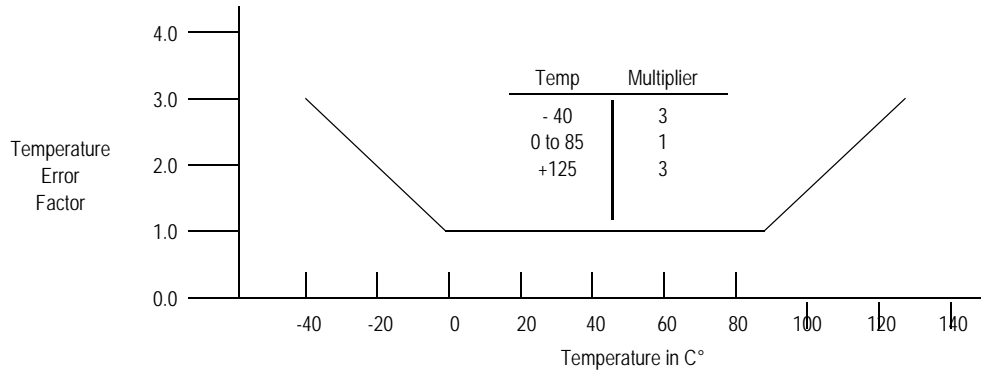

Figure 4. Output versus Absolute Pressure

Transfer Function

Nominal Transfer Value: $V_{OUT} = V_S (P \times 0.004 - 0.04)$
 $\pm (\text{Pressure Error} \times \text{Temp. Factor} \times 0.004 \times V_S)$
 $V_S = 5.1 \text{ V} \pm 0.25 V_{DC}$

Temperature Error Band



NOTE: The Temperature Multiplier is a linear response from 0x to -40°C and from 85° to 125°C.

Pressure Error Band

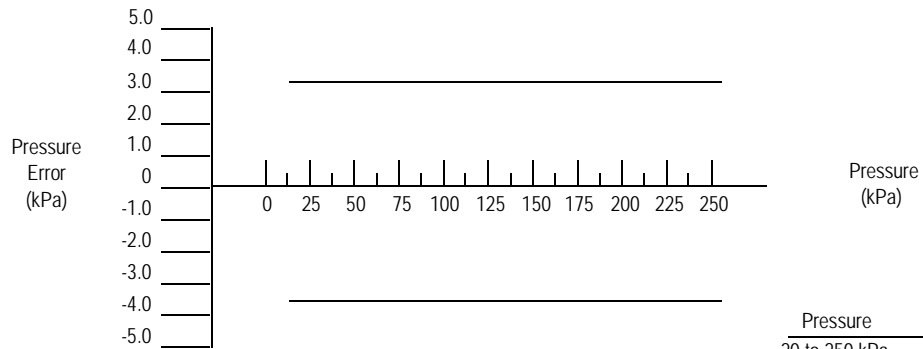

INFORMATION FOR USING THE SMALL OUTLINE PACKAGE (CASE 482)

MINIMUM RECOMMENDED FOOTPRINT FOR SURFACE MOUNTED APPLICATIONS

Surface mount board layout is a critical portion of the total design. The footprint for the surface mount packages must be the correct size to ensure proper solder connection interface between the board and the package. With the correct Footprint, the packages will self align when subjected to a

solder reflow process. It is always recommended to design boards with a solder mask layer to avoid bridging and shorting between solder pads.

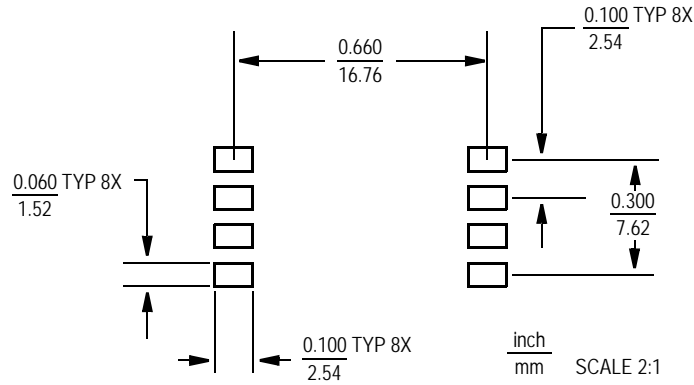
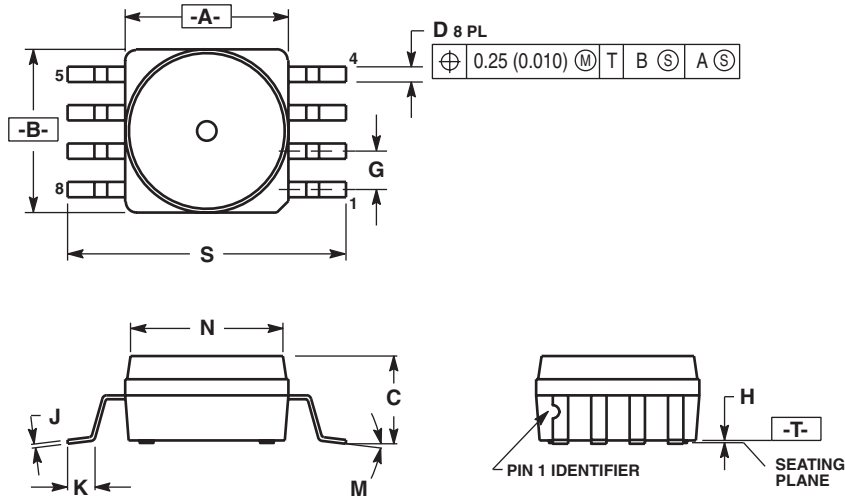

Figure 5. SOP Footprint (Case 482)

PACKAGE DIMENSIONS



- NOTES:
1. DIMENSIONING AND TOLERANCING PER ANSI Y14.5M, 1982.
 2. CONTROLLING DIMENSION: INCH.
 3. DIMENSION A AND B DO NOT INCLUDE MOLD PROTRUSION.
 4. MAXIMUM MOLD PROTRUSION 0.15 (0.006).
 5. ALL VERTICAL SURFACES 5° TYPICAL DRAFT.

DIM	INCHES		MILLIMETERS	
	MIN	MAX	MIN	MAX
A	0.415	0.425	10.54	10.79
B	0.415	0.425	10.54	10.79
C	0.212	0.230	5.38	5.84
D	0.038	0.042	0.96	1.07
G	0.100 BSC		2.54 BSC	
H	0.002	0.010	0.05	0.25
J	0.009	0.011	0.23	0.28
K	0.061	0.071	1.55	1.80
M	0°	7°	0°	7°
N	0.405	0.415	10.29	10.54
S	0.709	0.725	18.01	18.41

CASE 482-01
 ISSUE O
 SMALL OUTLINE PACKAGE

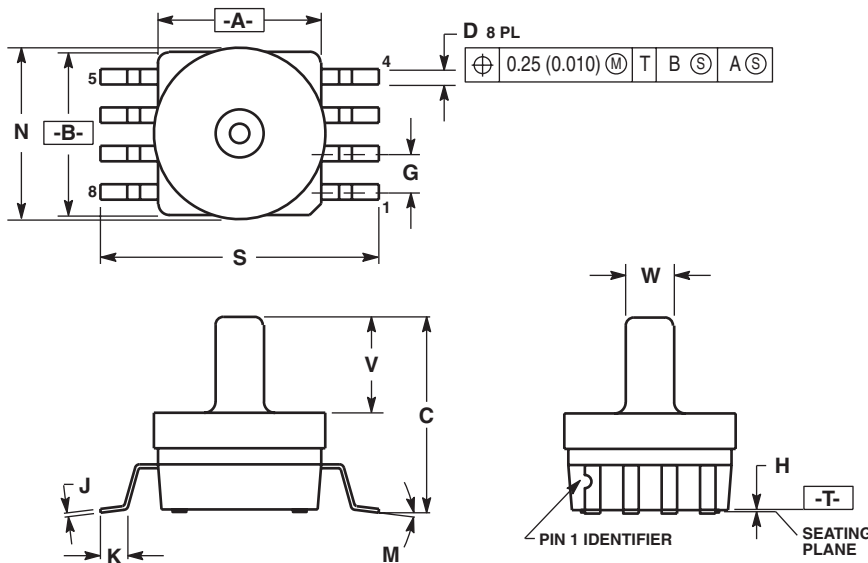

- NOTES:
1. DIMENSIONING AND TOLERANCING PER ANSI Y14.5M, 1982.
 2. CONTROLLING DIMENSION: INCH.
 3. DIMENSION A AND B DO NOT INCLUDE MOLD PROTRUSION.
 4. MAXIMUM MOLD PROTRUSION 0.15 (0.006).
 5. ALL VERTICAL SURFACES 5° TYPICAL DRAFT.

DIM	INCHES		MILLIMETERS	
	MIN	MAX	MIN	MAX
A	0.415	0.425	10.54	10.79
B	0.415	0.425	10.54	10.79
C	0.500	0.520	12.70	13.21
D	0.038	0.042	0.96	1.07
G	0.100 BSC		2.54 BSC	
H	0.002	0.010	0.05	0.25
J	0.009	0.011	0.23	0.28
K	0.061	0.071	1.55	1.80
M	0°	7°	0°	7°
N	0.444	0.448	11.28	11.38
S	0.709	0.725	18.01	18.41
V	0.245	0.255	6.22	6.48
W	0.115	0.125	2.92	3.17

CASE 482A-01
 ISSUE A
 SMALL OUTLINE PACKAGE

PACKAGE DIMENSIONS

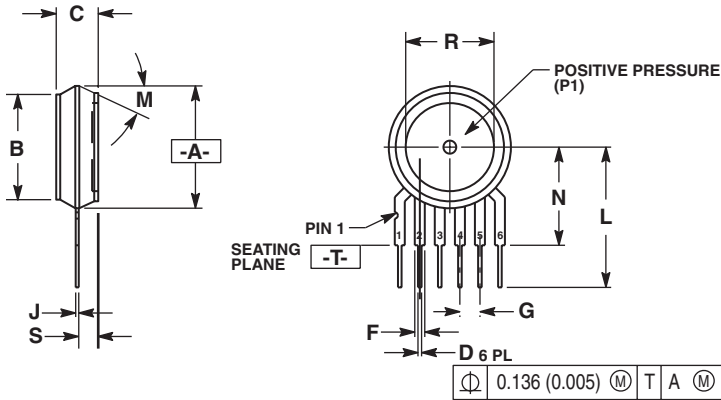

- NOTES:
1. DIMENSIONING AND TOLERANCING PER ANSI Y14.5M, 1982.
 2. CONTROLLING DIMENSION: INCH.
 3. DIMENSION -A- IS INCLUSIVE OF THE MOLD STOP RING. MOLD STOP RING NOT TO EXCEED 16.00 (0.630).

DIM	INCHES		MILLIMETERS	
	MIN	MAX	MIN	MAX
A	0.595	0.630	15.11	16.00
B	0.514	0.534	13.06	13.56
C	0.200	0.220	5.08	5.59
D	0.027	0.033	0.68	0.84
F	0.048	0.064	1.22	1.63
G	0.100 BSC		2.54 BSC	
J	0.014	0.016	0.36	0.40
L	0.695	0.725	17.65	18.42
M	30' NOM		30' NOM	
N	0.475	0.495	12.07	12.57
R	0.430	0.450	10.92	11.43
S	0.090	0.105	2.29	2.66

- STYLE 1:
 PIN 1. VOUT
 2. GROUND
 3. VCC
 4. V1
 5. V2
 6. VEX

- STYLE 2:
 PIN 1. OPEN
 2. GROUND
 3. -VOUT
 4. VSUPPLY
 5. +VOUT
 6. OPEN

- STYLE 3:
 PIN 1. OPEN
 2. GROUND
 3. +VOUT
 4. +VSUPPLY
 5. -VOUT
 6. OPEN

CASE 867-08
 ISSUE N
 UNIBODY PACKAGE

PACKAGE DIMENSIONS

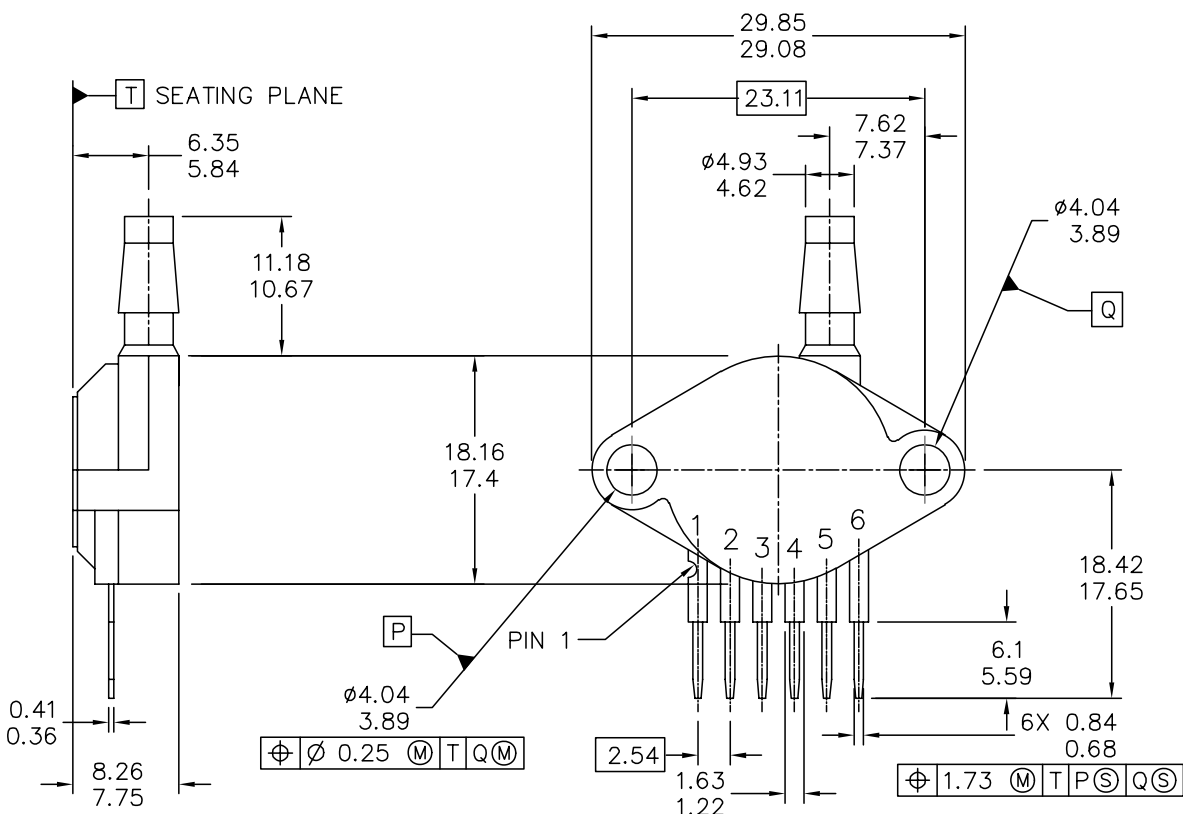

© FREESCALE SEMICONDUCTOR, INC. ALL RIGHTS RESERVED.	MECHANICAL OUTLINE	PRINT VERSION NOT TO SCALE	
TITLE: SENSOR, 6 LEAD UNIBODY CELL, AP & GP 01ASB09087B	DOCUMENT NO: 98ASB42796B	REV: G	
	CASE NUMBER: 867B-04	28 JUL 2005	
	STANDARD: NON-JEDEC		

**CASE 867B-04
ISSUE G
UNIBODY PACKAGE**

PACKAGE DIMENSIONS

NOTES:

1. DIMENSIONS ARE IN MILLIMETERS.
2. DIMENSIONS AND TOLERANCES PER ASME Y14.5M-1994.
3. 867B-01 THRU -3 OBSOLETE, NEW STANDARD 867B-04.

STYLE 1:

- PIN 1: V OUT
 2: GROUND
 3: VCC
 4: V1
 5: V2
 6: V EX

© FREESCALE SEMICONDUCTOR, INC. ALL RIGHTS RESERVED.	MECHANICAL OUTLINE	PRINT VERSION NOT TO SCALE	
TITLE: SENSOR, 6 LEAD UNIBODY CELL, AP & GP 01ASB09087B	DOCUMENT NO: 98ASB42796B	REV: G	
	CASE NUMBER: 867B-04	28 JUL 2005	
	STANDARD: NON-JEDEC		

PAGE 2 OF 2

**CASE 867B-04
 ISSUE G
 UNIBODY PACKAGE**

How to Reach Us:

Home Page:

www.freescale.com

Web Support:

<http://www.freescale.com/support>

USA/Europe or Locations Not Listed:

Freescale Semiconductor, Inc.
Technical Information Center, EL516
2100 East Elliot Road
Tempe, Arizona 85284
1-800-521-6274 or +1-480-768-2130
www.freescale.com/support

Europe, Middle East, and Africa:

Freescale Halbleiter Deutschland GmbH
Technical Information Center
Schatzbogen 7
81829 Muenchen, Germany
+44 1296 380 456 (English)
+46 8 52200080 (English)
+49 89 92103 559 (German)
+33 1 69 35 48 48 (French)
www.freescale.com/support

Japan:

Freescale Semiconductor Japan Ltd.
Headquarters
ARCO Tower 15F
1-8-1, Shimo-Meguro, Meguro-ku,
Tokyo 153-0064
Japan
0120 191014 or +81 3 5437 9125
support.japan@freescale.com

Asia/Pacific:

Freescale Semiconductor China Ltd.
Exchange Building 23F
No. 118 Jianguo Road
Chaoyang District
Beijing 100022
China
+86 010 5879 8000
support.asia@freescale.com

For Literature Requests Only:

Freescale Semiconductor Literature Distribution Center
P.O. Box 5405
Denver, Colorado 80217
1-800-441-2447 or +1-303-675-2140
Fax: +1-303-675-2150
LDCForFreescaleSemiconductor@hibbertgroup.com

Information in this document is provided solely to enable system and software implementers to use Freescale Semiconductor products. There are no express or implied copyright licenses granted hereunder to design or fabricate any integrated circuits or integrated circuits based on the information in this document.

Freescale Semiconductor reserves the right to make changes without further notice to any products herein. Freescale Semiconductor makes no warranty, representation or guarantee regarding the suitability of its products for any particular purpose, nor does Freescale Semiconductor assume any liability arising out of the application or use of any product or circuit, and specifically disclaims any and all liability, including without limitation consequential or incidental damages. "Typical" parameters that may be provided in Freescale Semiconductor data sheets and/or specifications can and do vary in different applications and actual performance may vary over time. All operating parameters, including "Typicals", must be validated for each customer application by customer's technical experts. Freescale Semiconductor does not convey any license under its patent rights nor the rights of others. Freescale Semiconductor products are not designed, intended, or authorized for use as components in systems intended for surgical implant into the body, or other applications intended to support or sustain life, or for any other application in which the failure of the Freescale Semiconductor product could create a situation where personal injury or death may occur. Should Buyer purchase or use Freescale Semiconductor products for any such unintended or unauthorized application, Buyer shall indemnify and hold Freescale Semiconductor and its officers, employees, subsidiaries, affiliates, and distributors harmless against all claims, costs, damages, and expenses, and reasonable attorney fees arising out of, directly or indirectly, any claim of personal injury or death associated with such unintended or unauthorized use, even if such claim alleges that Freescale Semiconductor was negligent regarding the design or manufacture of the part.

Freescale™ and the Freescale logo are trademarks of Freescale Semiconductor, Inc. All other product or service names are the property of their respective owners.

© Freescale Semiconductor, Inc. 2009. All rights reserved.

