

V_{RSM}	V_{RRM}	(dv/dt) _{cr}	I_{TRMS} (maximum value for continuous operation)			
	V_{DRM}		180 A			
			I_{TAV} (sin. 180; $T_{case} = 80\text{ °C}$)			
V	V	V/ μ s	115 A			
500	400	500	–	–	SKKH 105/04 D	–
700	600	500	SKKT 105/06 D	SKKT 106/06 D	–	SKKH 106/06 D
900	800	500	SKKT 105/08 D	SKKT 106/08 D ¹⁾	SKKH 105/08 D	SKKH 106/08 D
1300	1200	1000	SKKT 105/12 E	SKKT 106/12 E ¹⁾	SKKH 105/12 E	SKKH 106/12 E
1500	1400	1000	SKKT 105/14 E	SKKT 106/14 E ¹⁾	SKKH 105/14 E	SKKH 106/14 E
1700	1600	1000	SKKT 105/16 E	SKKT 106/16 E ¹⁾	SKKH 105/16 E	SKKH 106/16 E
1900	1800	1000	SKKT 105/18 E	SKKT 106/18 E ¹⁾	SKKH 105/18 E	SKKH 106/18 E

SEMIPACK® 1 Thyristor / Diode Modules

SKKT 105 SKKH 105
SKKT 106 SKKH 106
SKKT 106B



Symbol	Conditions	SKKT 105 SKKH 105	SKKT 106 SKKT 106B SKKH 106	Units
I_{TAV}	sin. 180; $T_{case} = 85\text{ °C}$		106	A
I_D	B2/B6 $T_{amb} = 35\text{ °C}$; P 3/180 F		145 / 180	A
			190 / 260	A
I_{RMS}	W1/W3 $T_{amb} = 35\text{ °C}$; P 3/180 F		200 / 3 x 140	A
I_{TSM}	$T_{vj} = 25\text{ °C}$; 10 ms		2 250	A
	$T_{vj} = 130\text{ °C}$; 10 ms		1 900	A
i^2t	$T_{vj} = 25\text{ °C}$; 8,3 ... 10 ms		25 000	A ² s
	$T_{vj} = 130\text{ °C}$; 8,3 ... 10 ms		18 000	A ² s
t_{gd}	$T_{vj} = 25\text{ °C}$; $I_G = 1\text{ A}$ $di_G/dt = 1\text{ A}/\mu\text{s}$		1	μs
t_{gr}	$V_D = 0,67 \cdot V_{DRM}$		2	μs
(di/dt) _{cr}	$T_{vj} = 130\text{ °C}$		150	A/ μs
t_q	$T_{vj} = 130\text{ °C}$		typ. 100	μs
I_H	$T_{vj} = 25\text{ °C}$; typ./max.		150 / 250	mA
I_L	$T_{vj} = 25\text{ °C}$; $R_G = 33\ \Omega$; typ./max.		300 / 600	mA
V_T	$T_{vj} = 25\text{ °C}$; $I_T = 300\text{ A}$		max. 1,65	V
$V_{T(TO)}$	$T_{vj} = 130\text{ °C}$		0,9	V
r_T	$T_{vj} = 130\text{ °C}$		2	m Ω
I_{DD} ; I_{RD}	$T_{vj} = 130\text{ °C}$; $V_{RD} = V_{RRM}$ $V_{DD} = V_{DRM}$		max. 20	mA
V_{GT}	$T_{vj} = 25\text{ °C}$; d.c.		3	V
I_{GT}	$T_{vj} = 25\text{ °C}$; d.c.		150	mA
V_{GD}	$T_{vj} = 130\text{ °C}$; d.c.		0,25	V
I_{GD}	$T_{vj} = 130\text{ °C}$; d.c.		6	mA
R_{thjc}	cont. } sin. 180 } per thyristor / rec. 120 } per module		0,28 / 0,14 0,30 / 0,15 0,32 / 0,16	$^{\circ}\text{C}/\text{W}$
R_{thch}			0,2 / 0,1	$^{\circ}\text{C}/\text{W}$
T_{vj}			- 40 ... + 130	$^{\circ}\text{C}$
T_{stg}			- 40 ... + 125	$^{\circ}\text{C}$
V_{isol}	a. c. 50 Hz; r.m.s.; 1 s/1 min		3600 / 3000	V~
M_1	to heatsink } SI (US) units to terminals }		5 (44 lb. in.) $\pm 15\%$ ²⁾	Nm
M_2			3 (26 lb. in.) $\pm 15\%$ ²⁾	Nm
a			5 · 9,81	m/s ²
w	approx.		95	g
Case	→ page B 1 – 95	SKKT 105: A 5 SKKH 105: A 6	SKKT 106: A 46 SKKT 106B: A 48 SKKH 106: A 47	



SKKT 105 SKKH 105



SKKT 106 SKKH 106
SKKT 106B

Features

- Heat transfer through aluminium oxide ceramic isolated metal baseplate
- Hard soldered joints for high reliability
- UL recognized, file no. E 63 532

Typical Applications

- DC motor control (e.g. for machine tools)
- AC motor soft starters
- Temperature control (e.g. for ovens, chemical processes)
- Professional light dimming (studios, theaters)

¹⁾ Also available in SKKT 106 B configuration (case A 48)

²⁾ See the assembly instructions

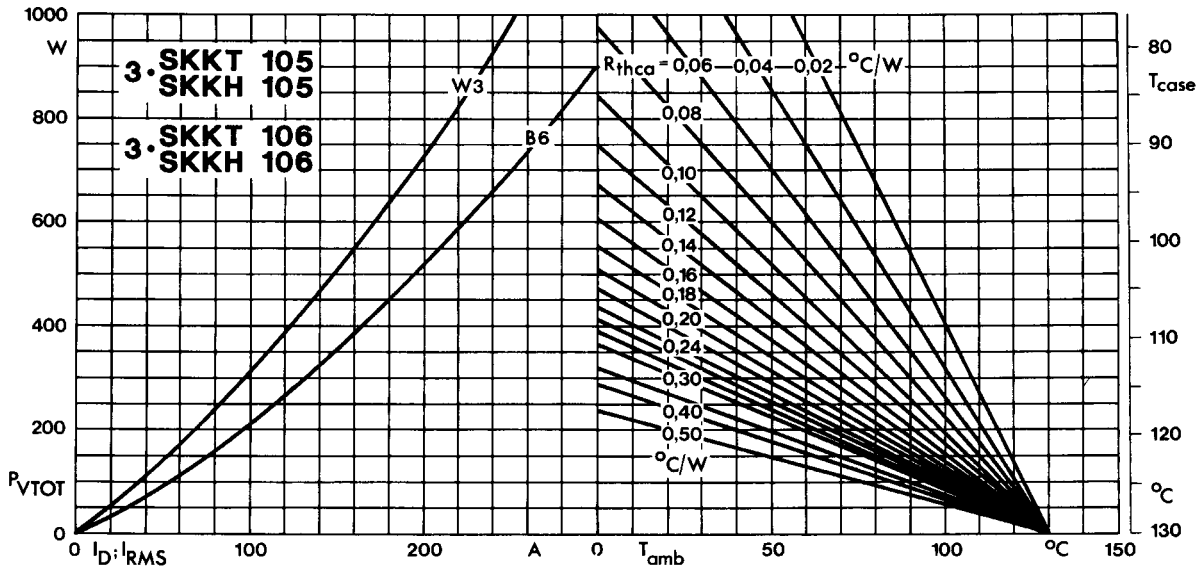

Fig. 4 Power dissipation of three modules vs. direct and rms current and case temperature

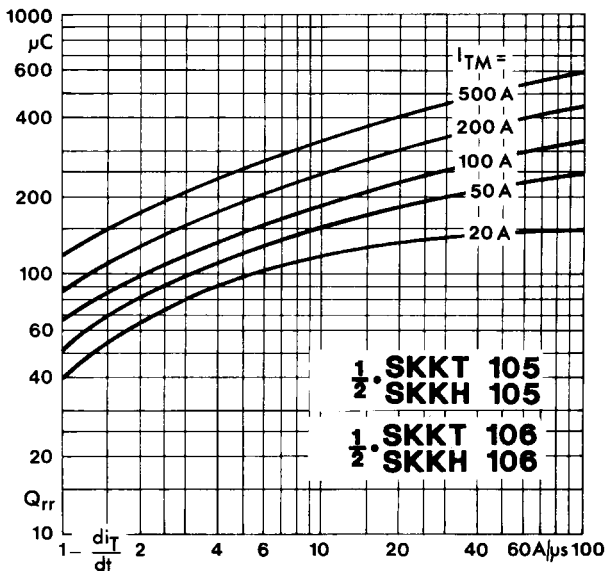

Fig. 5 Recovered charge vs. current decrease

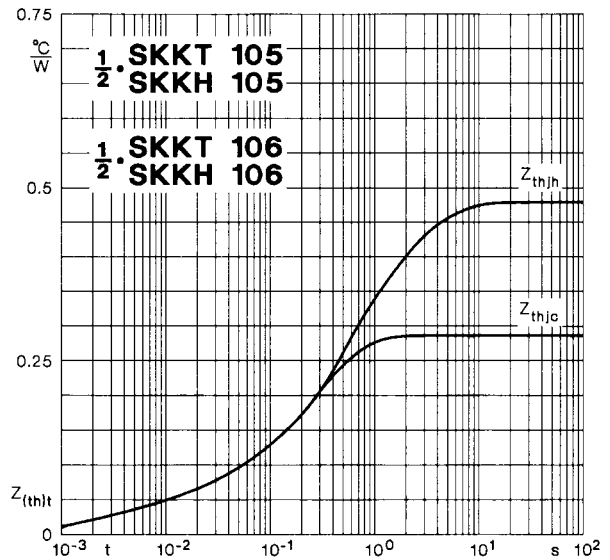

Fig. 6 Transient thermal impedance vs. time

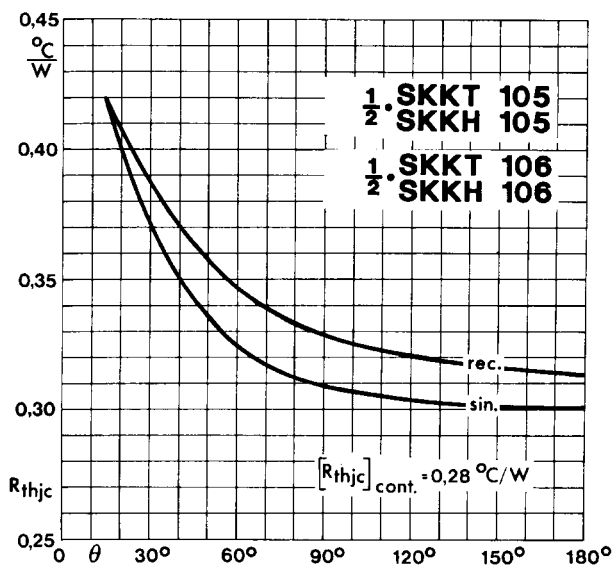

Fig. 7 Thermal resistance vs. conduction angle

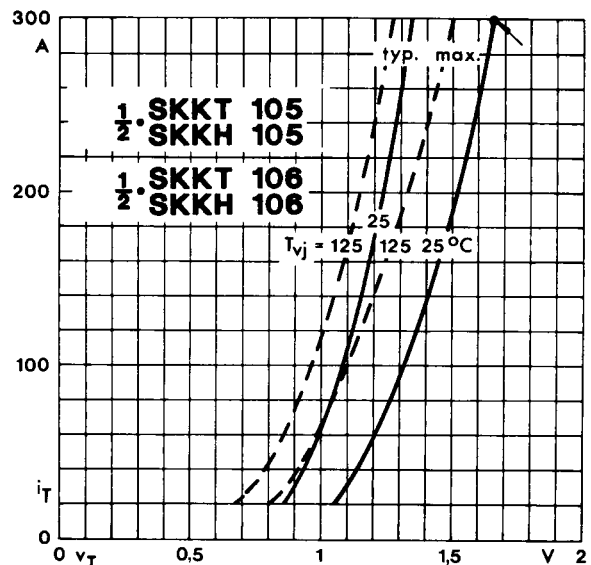

Fig. 8 On-state characteristics

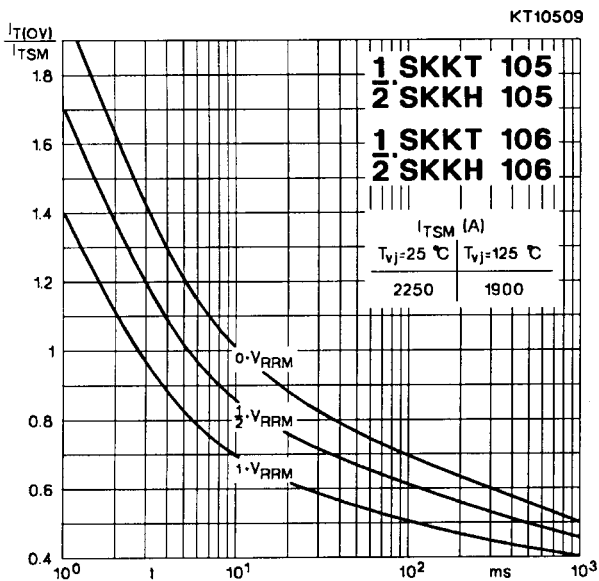

Fig. 9 Surge overload current vs. time

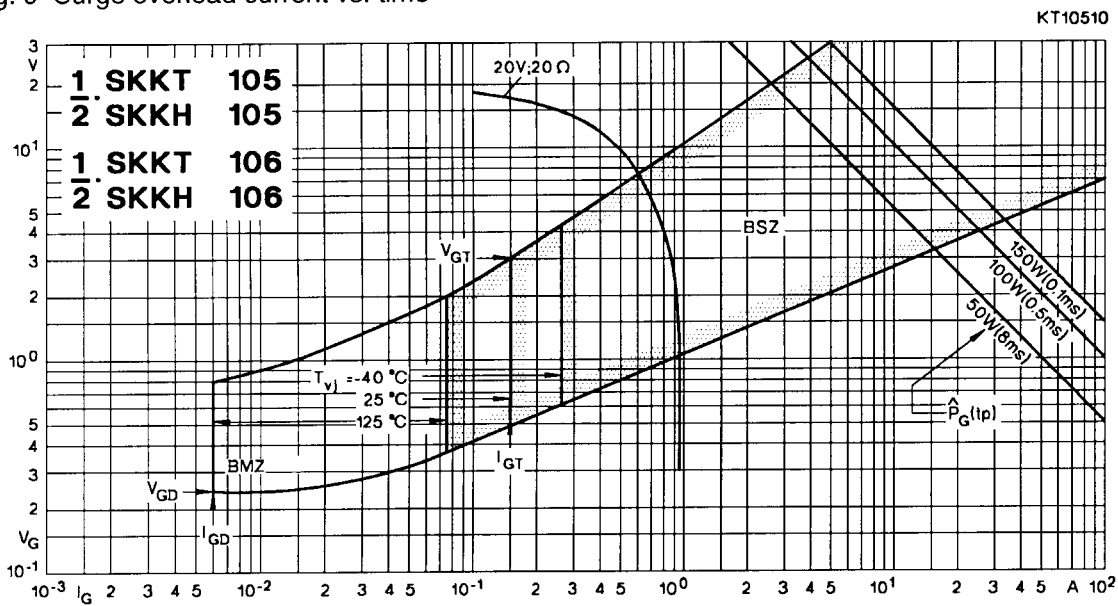

Fig. 10 Gate trigger characteristics

SKKT 19 ... 105

Case A 5

IEC 192-2: A 77 A

JEDEC: TO-240 AA

SEMIPACK® 1

UL recognized, file no. E 63 532



Dimensions in mm

SKKT 20/ ... 106/

Case A 46

IEC 192-2: A 77 A

JEDEC: TO-240 AA

SEMIPACK® 1

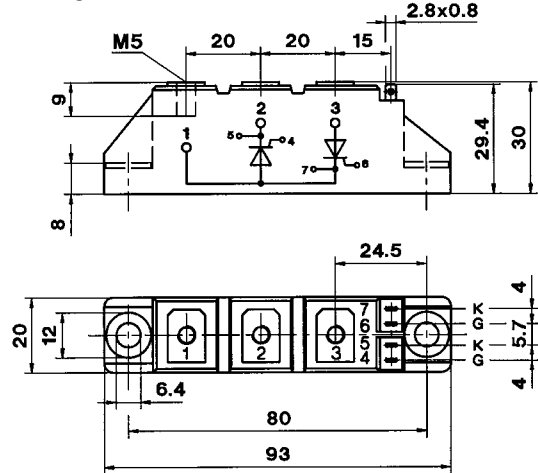

Dimensions in mm

SKKH 26 ... 105

Case A 6

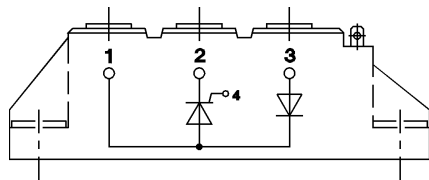

SKKD 26 ... 100

Case A 10

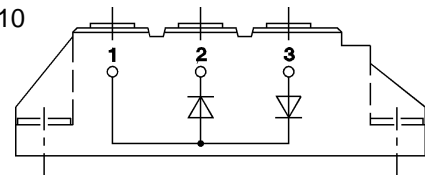

SKNH 56 ... 91

Case A 7

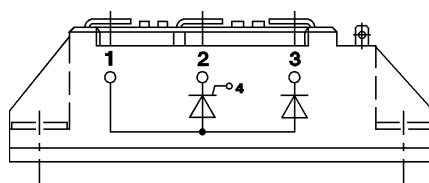

SKKE 81

Case A 12

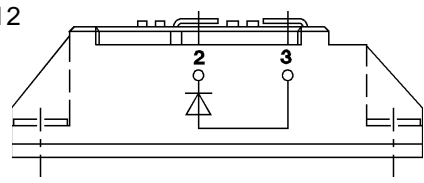

SKKL 56 ... 105

Case A 9

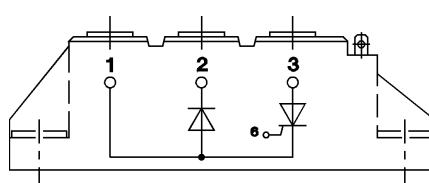

SKKH 27 ... 106

Case A 47

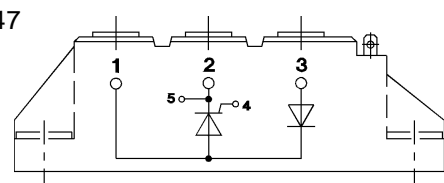

SKND 46 ... 81

Case A 19

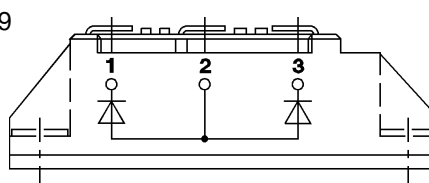

SKKT 20 B ... 106 B

Case A 48

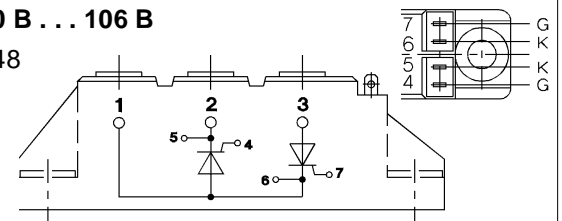

SKMT 92

Case A 72

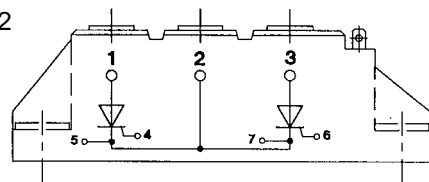

SKKL 42 ... 106

Case A 59

