

UL 489 and UL 1077 DIN rail miniature circuit breakers

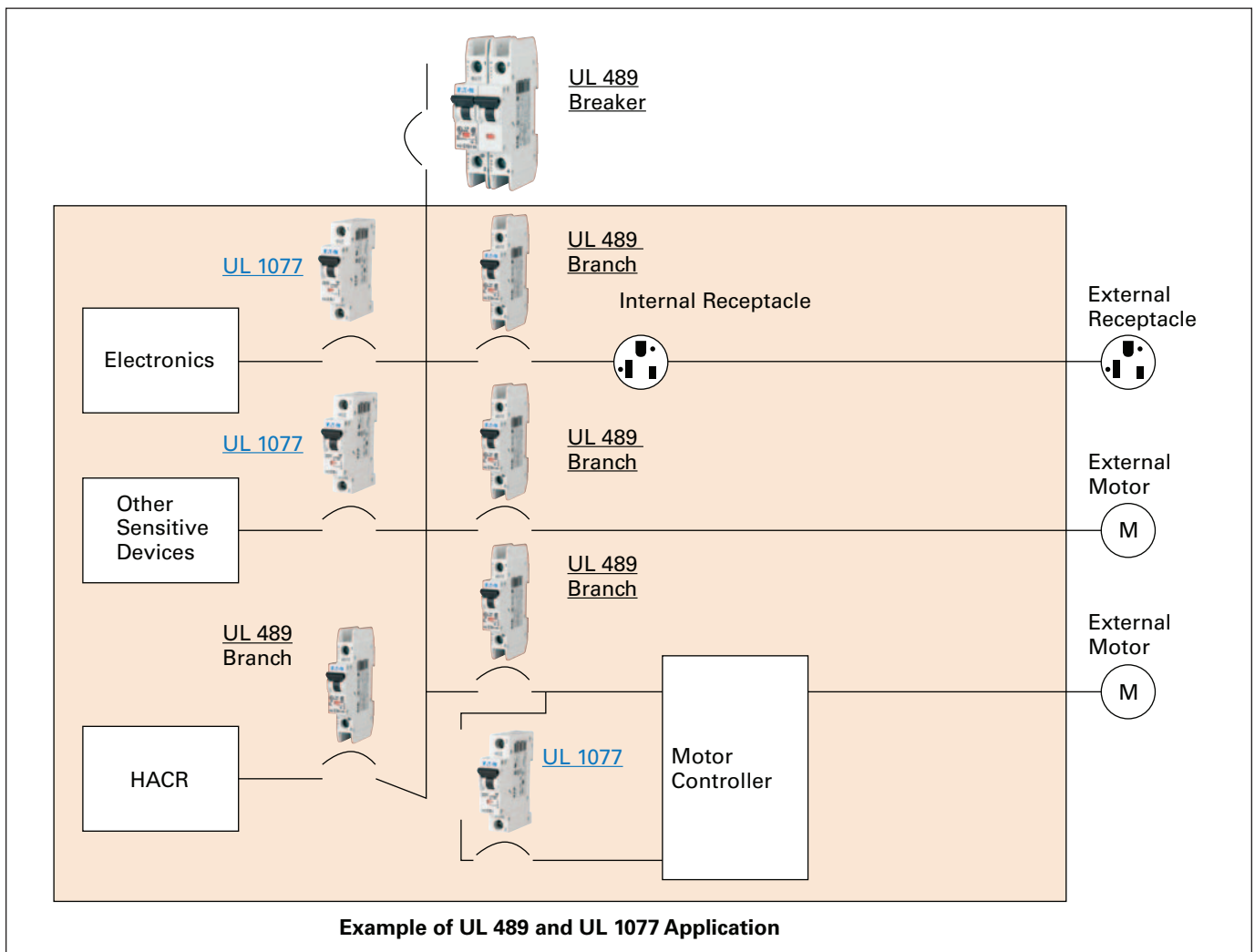

Powering Business Worldwide

Application guidelines for UL 489 circuit breakers and UL 1077 supplementary protectors



UL 489 circuit breakers

Used for branch circuit protection, internal/external receptacles, external motors and HACR equipment (heating, air conditioning and refrigeration).

UL 1077 supplementary protectors

Used for overcurrent protection within appliances or electrical equipment, where branch circuit protection is already provided or not required.

Note: UL 489 devices can be used in place of UL 1077; UL 1077 devices cannot be used in place of UL 489.

UL 489 and UL 1077 DIN rail miniature circuit breakers

UL 489 DIN rail branch circuit breakers

Product overview	2
Product selection	
FAZ-NA—B curve (3–5X I_n current rating)	4
FAZ-NA—C curve (5–10X I_n current rating)	5
FAZ-NA—D curve (10–20X I_n current rating)	6
FAZ-NA-DC—10 kAIC at 125 Vdc per pole	7
Accessories	8
Technical data	10
Accessory technical data	14

UL 1077 DIN rail supplementary protectors

Product overview	17
Product selection	
FAZ—B curve (3–5X I_n current rating)	19
FAZ—C curve (5–10X I_n current rating)	20
FAZ—D curve (10–20X I_n current rating)	21
FAZ—K curve (8–12X I_n current rating)	22
FAZ—S curve (13–17X I_n current rating)	23
FAZ—Z curve (2–3X I_n current rating)	24
Accessories	27
Technical data	28
Accessory technical data	33

Miniature circuit breaker application

FAZ circuit breakers	37
----------------------	----

UL 489 DIN rail branch circuit breakers

FAZ-NA circuit breakers

PRODUCT OVERVIEW

Optimum and efficient protection



Optimum product quality, tested reliability and safety stand for best protection of personnel, installations and plant. Eaton's FAZ-NA DIN rail mountable circuit breaker is designed for use in branch service applications.

Powerful offering for machine and system builders

The FAZ-NA is available with B, C and D characteristics in accordance with UL® 489, CSA® C22.2 No.5; UL 1077, CSA C22.2 No.235 and IEC 60947-2. These devices are CE marked.

Typical applications

Feeder and branch circuit protection

- Convenience receptacle circuits (internal/external)
- Motor control circuits
- Load circuits leaving the equipment (external)
- HACR equipment (heating, air conditioning, refrigeration) (internal/external)
- PLC I/O points
- Computers
- Power supplies
- Control instrumentation
- Relays
- UPS
- Power conditioners

Features

- Complete range of UL 489 listed DIN rail mounted miniature circuit breakers up to 40A current rating
- Standard ratings of 10 kAIC up to 277/480 Vac
- Select amperages available at 14 kAIC up to 277/480 Vac and 10 kAIC up to 125 Vdc per pole
- Current limiting design provides fast short-circuit interruption that reduces the let-through energy, which can damage the circuit

- Suitable for branch circuit device protection
- Thermal-magnetic overcurrent protection
 - Three levels of short-circuit protection, categorized by B, C and D curves
- Trip-free design—breaker can not be defeated by holding the handle in the ON position
- Captive screws cannot be lost
- SWD (switching duty)—suitable for switching fluorescent lighting loads ($I_n \leq 20A$)
- Fulfill UL 489, CSA C22.2 No.5 and also IEC 60947-2 Standard
- For use in applications for which UL 1077 or CSA C22.2 No.235 are also allowed
- Field installable shunt trip and auxiliary switch subsequent mounting
- Separate version for ring-tongue connection (Type FAZ-RT), terminal screws can be removed (on both sides)
- Module width of only 17.7 mm (per pole)
- Contact Position Indicator (red/green)
- Easy installation on DIN rail
- Possibility for sealing the toggle in ON or OFF position

FAZ-NA complies with the latest national and international standards

Standards—Feeder and Branch Circuit Protection

UL 489

Standard for molded case circuit breakers (MCCB) for feeder and branch circuit protection.	
Products meet the requirements of the National Electrical Code® (NEC®).	

CSA C22.2 No.5

Standard for molded case circuit breakers (MCCB) for feeder and branch circuit protection (corresponds closely to UL 489 Standard).	
Products meet the requirements of the Canadian Electrical Code (CEC).	

RoHS

These devices are RoHS compliant.	
-----------------------------------	---

VDE

These devices are VDE compliant.	
----------------------------------	---

ABS

These devices are ABS compliant.	
----------------------------------	---

UL 489 DIN rail branch circuit breakers

FAZ-NA circuit breakers

PRODUCT OVERVIEW

Tripping curves to choose from

Eaton FAZ-NA branch circuit breakers are available with “B,” “C” and “D” tripping characteristics. B-curve devices are suitable for applications where low levels of inrush current are expected.

C-curve devices are suitable for applications where medium levels of inrush current are expected. Applications include small transformers, lighting, pilot devices, control circuits and coils. C-curve devices provide a medium magnetic trip point.

D-curve devices are suitable for applications where high levels of inrush current are expected. The high magnetic trip point prevents nuisance tripping in high inductive applications such as motors, transformers and power supplies.

Eaton FAZ-NA devices are current limiting, which means they interrupt fault currents within one half cycle of the fault. Current limiting devices offer superior protection by reducing peak let-through current and energy.

Device printing on front and side

Installation options

These branch circuit breakers are available in two terminal configurations: standard box terminals that accept multiple conductors and ring-tongue terminals, ideally suited to demanding requirements of the semi-conductor industry. All breakers mount on standard 35 mm DIN rail. Bus connectors and feeder terminal facilitate mounting and wiring of multiple miniature circuit breaker arrays in control panel assemblies. These circuit breakers can also be reverse feed.

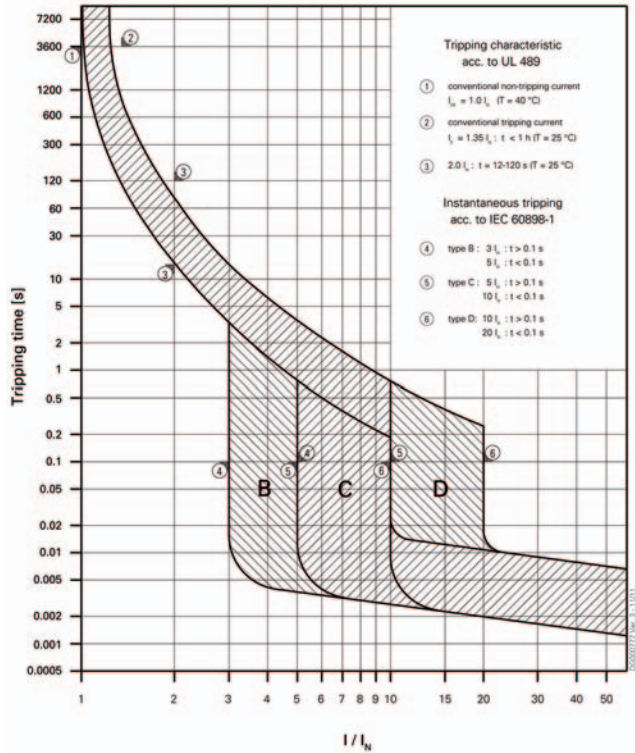

Catalog Numbering System

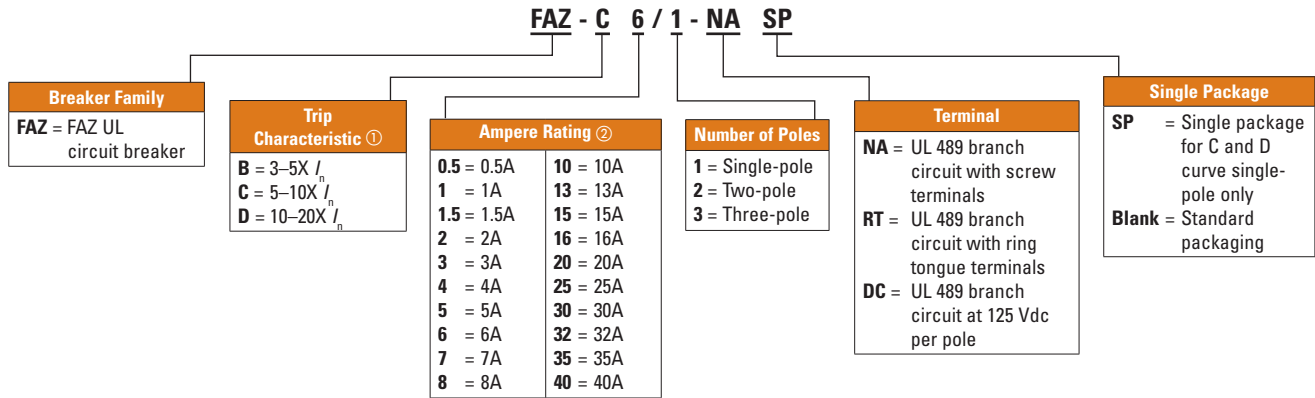

① I_n = Rated current for instantaneous trip characteristics.

② B curve starts at 1 ampere.

UL 489 DIN rail branch circuit breakers

FAZ-NA circuit breakers

PRODUCT SELECTION

FAZ-NA product selection

- UL approved (UL 489) and CSA Certified (CSA C22.2 No.5-02) as branch circuit breakers
- Interrupting capacity: 10 kA UL/CSA; 15 kA IEC 60947-2
- Current limiting device
- UL file number E235139

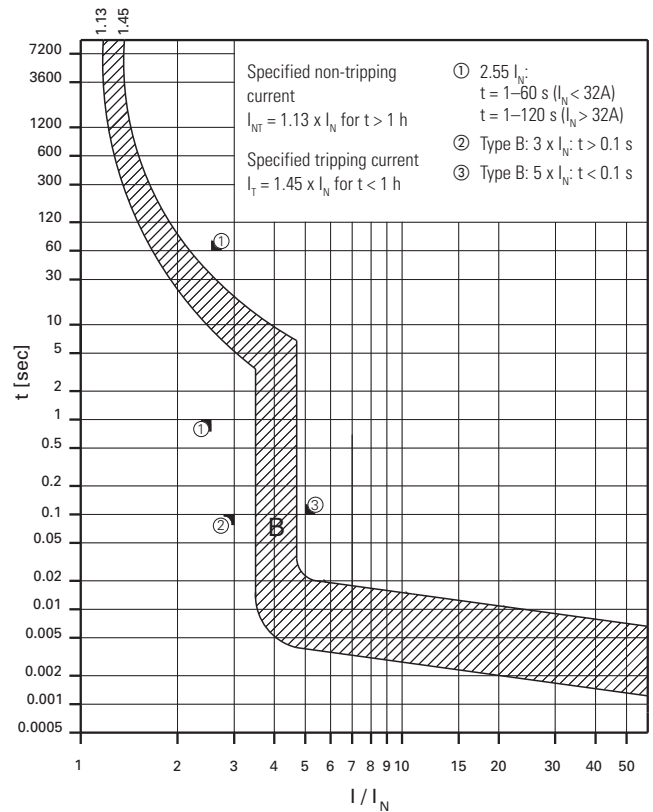

FAZ-NA UL 489 Circuit Breakers— 10 kAIC, 14 kAIC B Curve (15–25A)



	Single-pole ①	Two-pole	Three-pole
Amperes	Catalog Number	Catalog Number	Catalog Number
B Curve (3–5X I_n Current Rating)			
1	FAZ-B1/1-NA	FAZ-B1/2-NA	FAZ-B1/3-NA
1.5	FAZ-B1.5/1-NA	FAZ-B1.5/2-NA	FAZ-B1.5/3-NA
2	FAZ-B2/1-NA	FAZ-B2/2-NA	FAZ-B2/3-NA
3	FAZ-B3/1-NA	FAZ-B3/2-NA	FAZ-B3/3-NA
4	FAZ-B4/1-NA	FAZ-B4/2-NA	FAZ-B4/3-NA
5	FAZ-B5/1-NA	FAZ-B5/2-NA	FAZ-B5/3-NA
6	FAZ-B6/1-NA	FAZ-B6/2-NA	FAZ-B6/3-NA
7	FAZ-B7/1-NA	FAZ-B7/2-NA	FAZ-B7/3-NA
8	FAZ-B8/1-NA	FAZ-B8/2-NA	FAZ-B8/3-NA
10	FAZ-B10/1-NA	FAZ-B10/2-NA	FAZ-B10/3-NA
13	FAZ-B13/1-NA	FAZ-B13/2-NA	FAZ-B13/3-NA
15	FAZ-B15/1-NA	FAZ-B15/2-NA	FAZ-B15/3-NA
16	FAZ-B16/1-NA	FAZ-B16/2-NA	FAZ-B16/3-NA
20	FAZ-B20/1-NA	FAZ-B20/2-NA	FAZ-B20/3-NA
25	FAZ-B25/1-NA	FAZ-B25/2-NA	FAZ-B25/3-NA
30	FAZ-B30/1-NA	FAZ-B30/2-NA	FAZ-B30/3-NA
32	FAZ-B32/1-NA	FAZ-B32/2-NA	FAZ-B32/3-NA
35 ②	FAZ-B35/1-NA	FAZ-B35/2-NA	FAZ-B35/3-NA
40 ②	FAZ-B40/1-NA	FAZ-B40/2-NA	FAZ-B40/3-NA

FAZ-RT UL 489 Circuit Breakers with Ring-Tongue Terminals— 10 kAIC, 14 kAIC B Curve (15–25A)



	Single-pole ①	Two-pole	Three-pole
Amperes	Catalog Number	Catalog Number	Catalog Number
B Curve with Ring-Tongue Terminals (3–5X I_n Current Rating)			
1	FAZ-B1/1-RT	FAZ-B1/2-RT	FAZ-B1/3-RT
1.5	FAZ-B1.5/1-RT	FAZ-B1.5/2-RT	FAZ-B1.5/3-RT
2	FAZ-B2/1-RT	FAZ-B2/2-RT	FAZ-B2/3-RT
3	FAZ-B3/1-RT	FAZ-B3/2-RT	FAZ-B3/3-RT
4	FAZ-B4/1-RT	FAZ-B4/2-RT	FAZ-B4/3-RT
5	FAZ-B5/1-RT	FAZ-B5/2-RT	FAZ-B5/3-RT
6	FAZ-B6/1-RT	FAZ-B6/2-RT	FAZ-B6/3-RT
7	FAZ-B7/1-RT	FAZ-B7/2-RT	FAZ-B7/3-RT
8	FAZ-B8/1-RT	FAZ-B8/2-RT	FAZ-B8/3-RT
10	FAZ-B10/1-RT	FAZ-B10/2-RT	FAZ-B10/3-RT
13	FAZ-B13/1-RT	FAZ-B13/2-RT	FAZ-B13/3-RT
15	FAZ-B15/1-RT	FAZ-B15/2-RT	FAZ-B15/3-RT
16	FAZ-B16/1-RT	FAZ-B16/2-RT	FAZ-B16/3-RT
20	FAZ-B20/1-RT	FAZ-B20/2-RT	FAZ-B20/3-RT
25	FAZ-B25/1-RT	FAZ-B25/2-RT	FAZ-B25/3-RT
30	FAZ-B30/1-RT	FAZ-B30/2-RT	FAZ-B30/3-RT
32	FAZ-B32/1-RT	FAZ-B32/2-RT	FAZ-B32/3-RT
35 ②	FAZ-B35/1-RT	FAZ-B35/2-RT	FAZ-B35/3-RT
40 ②	FAZ-B40/1-RT	FAZ-B40/2-RT	FAZ-B40/3-RT

① Two-piece order. Quantities of two per box.

② 240 Vac rated only.

UL 489 DIN rail branch circuit breakers

FAZ-NA circuit breakers

PRODUCT SELECTION

FAZ-NA product selection

- UL approved (UL 489) and CSA Certified (CSA C22.2 No.5-02) as branch circuit breakers
- Interrupting capacity: 10 kA UL/CSA; 15 kA IEC 60947-2
- Current limiting device
- UL file number E235139

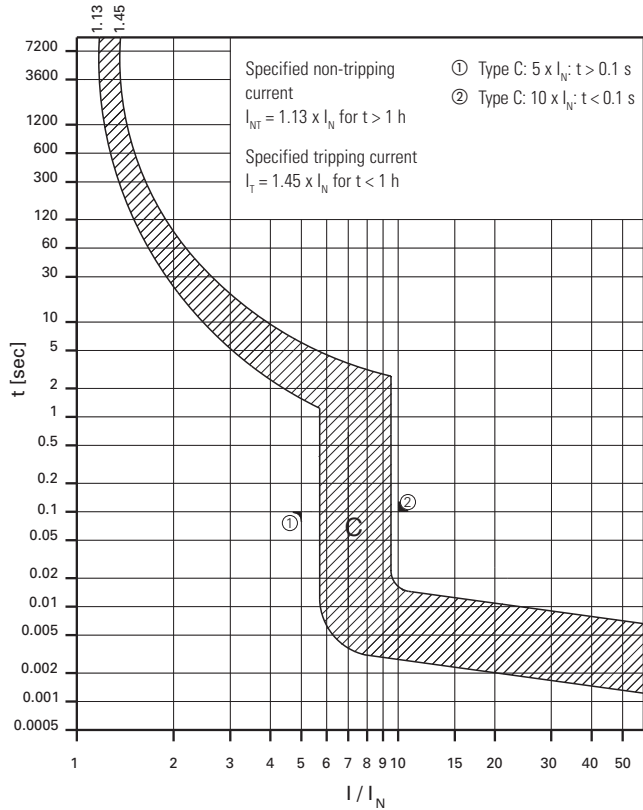

FAZ-NA UL 489 Circuit Breakers—10 kAIC, 14 kAIC C Curve (15–25A)



	Single-pole ①	Two-pole	Three-pole
Amperes	Catalog Number	Catalog Number	Catalog Number
C Curve (5–10X I_n Current Rating)			
0.5	FAZ-C0.5/1-NA-SP	FAZ-C0.5/2-NA	FAZ-C0.5/3-NA
1	FAZ-C1/1-NA-SP	FAZ-C1/2-NA	FAZ-C1/3-NA
1.5	FAZ-C1.5/1-NA-SP	FAZ-C1.5/2-NA	FAZ-C1.5/3-NA
2	FAZ-C2/1-NA-SP	FAZ-C2/2-NA	FAZ-C2/3-NA
3	FAZ-C3/1-NA-SP	FAZ-C3/2-NA	FAZ-C3/3-NA
4	FAZ-C4/1-NA-SP	FAZ-C4/2-NA	FAZ-C4/3-NA
5	FAZ-C5/1-NA-SP	FAZ-C5/2-NA	FAZ-C5/3-NA
6	FAZ-C6/1-NA-SP	FAZ-C6/2-NA	FAZ-C6/3-NA
7	FAZ-C7/1-NA-SP	FAZ-C7/2-NA	FAZ-C7/3-NA
8	FAZ-C8/1-NA-SP	FAZ-C8/2-NA	FAZ-C8/3-NA
10	FAZ-C10/1-NA-SP	FAZ-C10/2-NA	FAZ-C10/3-NA
13	FAZ-C13/1-NA-SP	FAZ-C13/2-NA	FAZ-C13/3-NA
15	FAZ-C15/1-NA-SP	FAZ-C15/2-NA	FAZ-C15/3-NA
16	FAZ-C16/1-NA-SP	FAZ-C16/2-NA	FAZ-C16/3-NA
20	FAZ-C20/1-NA-SP	FAZ-C20/2-NA	FAZ-C20/3-NA
25	FAZ-C25/1-NA-SP	FAZ-C25/2-NA	FAZ-C25/3-NA
30	FAZ-C30/1-NA-SP	FAZ-C30/2-NA	FAZ-C30/3-NA
32	FAZ-C32/1-NA-SP	FAZ-C32/2-NA	FAZ-C32/3-NA
35 ②	FAZ-C35/1-NA-SP	FAZ-C35/2-NA	FAZ-C35/3-NA
40 ②	FAZ-C40/1-NA-SP	FAZ-C40/2-NA	FAZ-C40/3-NA

FAZ-RT UL 489 Circuit Breakers with Ring-Tongue Terminals—10 kAIC, 14 kAIC C Curve (15–25A)



	Single-pole	Two-pole	Three-pole
Amperes	Catalog Number	Catalog Number	Catalog Number
C Curve with Ring-Tongue Terminals (5–10X I_n Current Rating)			
0.5	FAZ-C0.5/1-RT-SP	FAZ-C0.5/2-RT	FAZ-C0.5/3-RT
1	FAZ-C1/1-RT-SP	FAZ-C1/2-RT	FAZ-C1/3-RT
1.5	FAZ-C1.5/1-RT-SP	FAZ-C1.5/2-RT	FAZ-C1.5/3-RT
2	FAZ-C2/1-RT-SP	FAZ-C2/2-RT	FAZ-C2/3-RT
3	FAZ-C3/1-RT-SP	FAZ-C3/2-RT	FAZ-C3/3-RT
4	FAZ-C4/1-RT-SP	FAZ-C4/2-RT	FAZ-C4/3-RT
5	FAZ-C5/1-RT-SP	FAZ-C5/2-RT	FAZ-C5/3-RT
6	FAZ-C6/1-RT-SP	FAZ-C6/2-RT	FAZ-C6/3-RT
7	FAZ-C7/1-RT-SP	FAZ-C7/2-RT	FAZ-C7/3-RT
8	FAZ-C8/1-RT-SP	FAZ-C8/2-RT	FAZ-C8/3-RT
10	FAZ-C10/1-RT-SP	FAZ-C10/2-RT	FAZ-C10/3-RT
13	FAZ-C13/1-RT-SP	FAZ-C13/2-RT	FAZ-C13/3-RT
15	FAZ-C15/1-RT-SP	FAZ-C15/2-RT	FAZ-C15/3-RT
16	FAZ-C16/1-RT-SP	FAZ-C16/2-RT	FAZ-C16/3-RT
20	FAZ-C20/1-RT-SP	FAZ-C20/2-RT	FAZ-C20/3-RT
25	FAZ-C25/1-RT-SP	FAZ-C25/2-RT	FAZ-C25/3-RT
30	FAZ-C30/1-RT-SP	FAZ-C30/2-RT	FAZ-C30/3-RT
32	FAZ-C32/1-RT-SP	FAZ-C32/2-RT	FAZ-C32/3-RT
35 ②	FAZ-C35/1-RT-SP	FAZ-C35/2-RT	FAZ-C35/3-RT
40 ②	FAZ-C40/1-RT-SP	FAZ-C40/2-RT	FAZ-C40/3-RT

① Option for single packaging on single-pole C and D curves only; add suffix SP when ordering.

② 240 Vac rated only.

UL 489 DIN rail branch circuit breakers

FAZ-NA circuit breakers

PRODUCT SELECTION

FAZ-NA product selection

- UL approved (UL 489) and CSA Certified (CSA C22.2 No.5-02) as branch circuit breakers
- Interrupting capacity: 10 kA UL/CSA; 15 kA IEC 60947-2
- Current limiting device
- UL file number E235139

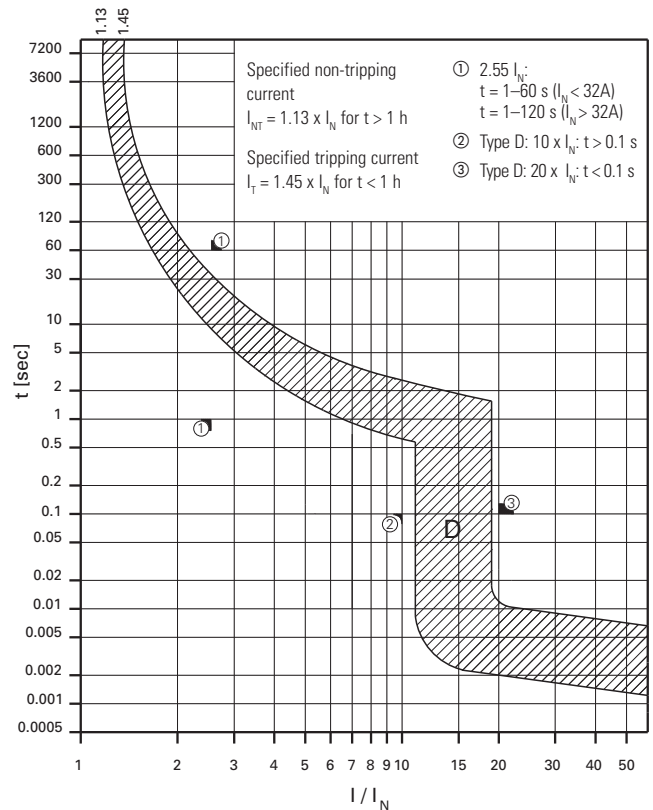

FAZ-NA UL 489 Circuit Breakers—10 kAIC, 14 kAIC D Curve (13–20A)



	Single-pole ①	Two-pole	Three-pole
Amperes	Catalog Number	Catalog Number	Catalog Number
D Curve (10–20X I_n Current Rating)			
0.5	FAZ-D0.5/1-NA-SP	FAZ-D0.5/2-NA	FAZ-D0.5/3-NA
1	FAZ-D1/1-NA-SP	FAZ-D1/2-NA	FAZ-D1/3-NA
1.5	FAZ-D1.5/1-NA-SP	FAZ-D1.5/2-NA	FAZ-D1.5/3-NA
2	FAZ-D2/1-NA-SP	FAZ-D2/2-NA	FAZ-D2/3-NA
3	FAZ-D3/1-NA-SP	FAZ-D3/2-NA	FAZ-D3/3-NA
4	FAZ-D4/1-NA-SP	FAZ-D4/2-NA	FAZ-D4/3-NA
5	FAZ-D5/1-NA-SP	FAZ-D5/2-NA	FAZ-D5/3-NA
6	FAZ-D6/1-NA-SP	FAZ-D6/2-NA	FAZ-D6/3-NA
7	FAZ-D7/1-NA-SP	FAZ-D7/2-NA	FAZ-D7/3-NA
8	FAZ-D8/1-NA-SP	FAZ-D8/2-NA	FAZ-D8/3-NA
10	FAZ-D10/1-NA-SP	FAZ-D10/2-NA	FAZ-D10/3-NA
13	FAZ-D13/1-NA-SP	FAZ-D13/2-NA	FAZ-D13/3-NA
15	FAZ-D15/1-NA-SP	FAZ-D15/2-NA	FAZ-D15/3-NA
16	FAZ-D16/1-NA-SP	FAZ-D16/2-NA	FAZ-D16/3-NA
20	FAZ-D20/1-NA-SP	FAZ-D20/2-NA	FAZ-D20/3-NA
25	FAZ-D25/1-NA-SP	FAZ-D25/2-NA	FAZ-D25/3-NA
30	FAZ-D30/1-NA-SP	FAZ-D30/2-NA	FAZ-D30/3-NA
32	FAZ-D32/1-NA-SP	FAZ-D32/2-NA	FAZ-D32/3-NA
35 ②	FAZ-D35/1-NA-SP	FAZ-D35/2-NA	FAZ-D35/3-NA
40 ②	FAZ-D40/1-NA-SP	FAZ-D40/2-NA	FAZ-D40/3-NA

FAZ-RT UL 489 Circuit Breakers with Ring-Tongue Terminals—10 kAIC, 14 kAIC D Curve (13–20A)



	Single-pole	Two-pole	Three-pole
Amperes	Catalog Number	Catalog Number	Catalog Number
D Curve with Ring-Tongue Terminals (10–20X I_n Current Rating)			
0.5	FAZ-D0.5/1-RT-SP	FAZ-D0.5/2-RT	FAZ-D0.5/3-RT
1	FAZ-D1/1-RT-SP	FAZ-D1/2-RT	FAZ-D1/3-RT
1.5	FAZ-D1.5/1-RT-SP	FAZ-D1.5/2-RT	FAZ-D1.5/3-RT
2	FAZ-D2/1-RT-SP	FAZ-D2/2-RT	FAZ-D2/3-RT
3	FAZ-D3/1-RT-SP	FAZ-D3/2-RT	FAZ-D3/3-RT
4	FAZ-D4/1-RT-SP	FAZ-D4/2-RT	FAZ-D4/3-RT
5	FAZ-D5/1-RT-SP	FAZ-D5/2-RT	FAZ-D5/3-RT
6	FAZ-D6/1-RT-SP	FAZ-D6/2-RT	FAZ-D6/3-RT
7	FAZ-D7/1-RT-SP	FAZ-D7/2-RT	FAZ-D7/3-RT
8	FAZ-D8/1-RT-SP	FAZ-D8/2-RT	FAZ-D8/3-RT
10	FAZ-D10/1-RT-SP	FAZ-D10/2-RT	FAZ-D10/3-RT
13	FAZ-D13/1-RT-SP	FAZ-D13/2-RT	FAZ-D13/3-RT
15	FAZ-D15/1-RT-SP	FAZ-D15/2-RT	FAZ-D15/3-RT
16	FAZ-D16/1-RT-SP	FAZ-D16/2-RT	FAZ-D16/3-RT
20	FAZ-D20/1-RT-SP	FAZ-D20/2-RT	FAZ-D20/3-RT
25	FAZ-D25/1-RT-SP	FAZ-D25/2-RT	FAZ-D25/3-RT
30	FAZ-D30/1-RT-SP	FAZ-D30/2-RT	FAZ-D30/3-RT
32	FAZ-D32/1-RT-SP	FAZ-D32/2-RT	FAZ-D32/3-RT
35 ②	FAZ-D35/1-RT-SP	FAZ-D35/2-RT	FAZ-D35/3-RT
40 ②	FAZ-D40/1-RT-SP	FAZ-D40/2-RT	FAZ-D40/3-RT

① Option for single packaging on single-pole C and D curves only; add suffix SP when ordering.

② 240 Vac rated only.

UL 489 DIN rail branch circuit breakers

FAZ-NA circuit breakers

PRODUCT SELECTION

FAZ-NA-DC product selection

- UL approved (UL 489) and CSA Certified (CSA C22.2 No.5-02) as Branch Circuit Breakers
- Interrupting capacity: 10 kA at 125 Vdc UL/CSA, 10 kA at 250 Vdc
- 125 Vdc for one-pole, 250 Vdc for two-pole in series
- Current limiting device
- Polarity (+/-) sensitive and not for use on photovoltaic string application
- UL file number E235139

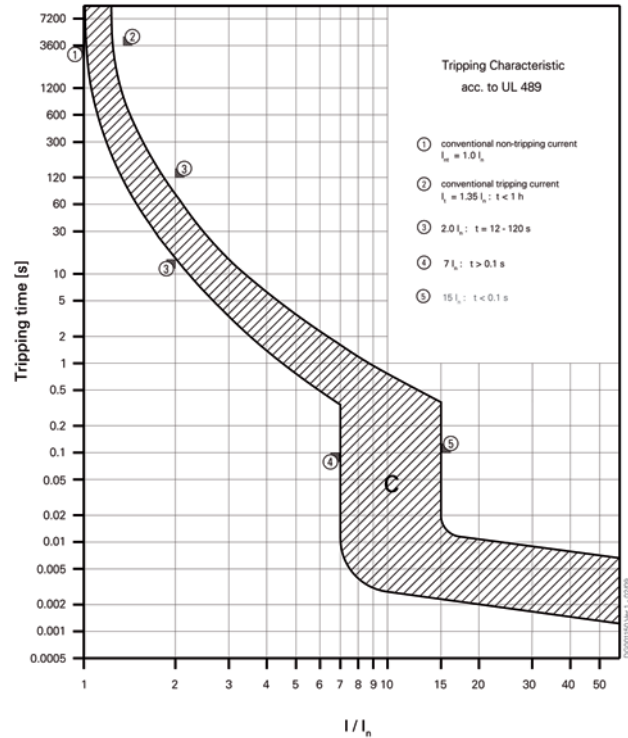

FAZ-NA-DC UL 489 Circuit Breakers— 10 kAIC at 125 Vdc per pole



Single-pole ①		Two-pole
Amperes	Catalog Number	Catalog Number
C Curve (5–10X I_n Current Rating)		
2	FAZ-C2/1-NA-DC-SP	FAZ-C2/2-NA-DC
3	FAZ-C3/1-NA-DC-SP	FAZ-C3/2-NA-DC
4	FAZ-C4/1-NA-DC-SP	FAZ-C4/2-NA-DC
5	FAZ-C5/1-NA-DC-SP	FAZ-C5/2-NA-DC
6	FAZ-C6/1-NA-DC-SP	FAZ-C6/2-NA-DC
7	FAZ-C7/1-NA-DC-SP	FAZ-C7/2-NA-DC
8	FAZ-C8/1-NA-DC-SP	FAZ-C8/2-NA-DC
10	FAZ-C10/1-NA-DC-SP	FAZ-C10/2-NA-DC
13	FAZ-C13/1-NA-DC-SP	FAZ-C13/2-NA-DC
15	FAZ-C15/1-NA-DC-SP	FAZ-C15/2-NA-DC
16	FAZ-C16/1-NA-DC-SP	FAZ-C16/2-NA-DC
20	FAZ-C20/1-NA-DC-SP	FAZ-C20/2-NA-DC
25	FAZ-C25/1-NA-DC-SP	FAZ-C25/2-NA-DC
30	FAZ-C30/1-NA-DC-SP	FAZ-C30/2-NA-DC
32	FAZ-C32/1-NA-DC-SP	FAZ-C32/2-NA-DC
35	FAZ-C35/1-NA-DC-SP	FAZ-C35/2-NA-DC
40	FAZ-C40/1-NA-DC-SP	FAZ-C40/2-NA-DC

① Option for single packaging on single-pole C curves only; add suffix SP when ordering.

UL 489 DIN rail branch circuit breakers





FAZ-NA circuit breakers

ACCESSORIES

Tripping signal switch Z-NHK, Z-IHK-NA

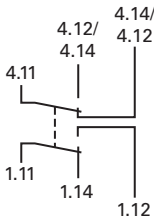
- Design according to IEC/EN 60947-5-1, IEC/EN 62019
- Field installable
- The specified minimum voltages are per contact—take into account particularly in case of series connection
- Self-cleaning contacts
- Contact material and design particularly suitable for extra low voltage
- Z-NHK: the function of one of the two change-over contacts can be switched from “auxiliary switch” to “tripping signal switch”
- Tripping signal contact transmits message of electric tripping, not mechanical switch-off
- Test key for contact function “electrical tripping”
- Z-IHK-NA: will allow for > 480Y/277 Vac rating

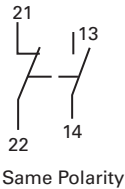
FAZ-NA UL 489 Breakers

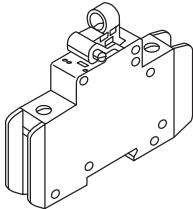
Accessory	Circuit Diagram	Description	Catalog Number
		Two-pole auxiliary contact/trip indicating contact	Z-NHK ①
		Auxiliary contact	Z-IHK-NA
		Shunt trip 110–415 Vac	FAZ-XAA-NA110-415VAC
		Shunt trip 12–110 Vac	FAZ-XAA-NA12-110VAC
		Padlock hasp	IS/SPE-1TE



① Voltage of FAZ-NA circuit breaker is limited to 300V with this auxiliary contact installed.

UL 489 DIN rail branch circuit breakers

FAZ-NA circuit breakers

ACCESSORIES

FAZ-NA UL 489 Breakers, continued

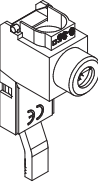
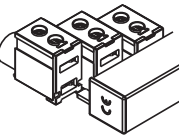
Accessory	Circuit Diagram	Description	Catalog Number
		Busbar—one-pole, 6 terminals ②③④⑤	Z-SV/UL-16/1P-1TE/6
		Busbar—one-pole, 12 terminals ②③④⑤	Z-SV/UL-16/1P-1TE/12
		Busbar—one-pole, 18 terminals ②③④⑤	Z-SV/UL-16/1P-1TE/1
		Busbar—two-pole, 6 terminals ②③④⑤	Z-SV/UL-16/2P-2TE/6
		Busbar—two-pole, 12 terminals ②③④⑤	Z-SV/UL-16/2P-2TE/12
		Busbar—two-pole, 18 terminals ②③④⑤	Z-SV/UL-16/2P-2TE/18
		Busbar—three-pole, 6 terminals ②③④⑤	Z-SV/UL-16/3P-3TE/6
		Busbar—three-pole, 12 terminals ②③④⑤	Z-SV/UL-16/3P-3TE/12
		Busbar—three-pole, 18 terminals ②③④⑤	Z-SV/UL-16/3P-3TE/18
		Three-pole busbar shroud	ZV-BS-UL
		Extension terminal—25 mm ² (2–14 AWG)	Z-EK/35/UL
		Bus connector— conductors up to 50 mm ² (~1/0 AWG)	Z-EB/50/UL

- ② Do not cut commoning link.
- ③ A maximum of three commoning links may be used in conjunction. Each breaker connected to the commoning link must have the same number of poles for proper use.
- ④ Not for use with ring-tongue circuit breakers.
- ⑤ Bus may be center fed for high current capacity.

Busbar Connection Example

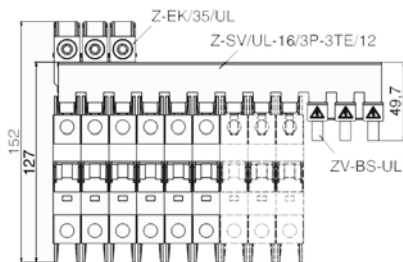

UL 489 DIN rail branch circuit breakers

FAZ-NA circuit breakers

TECHNICAL DATA

Miniature circuit breakers FAZ-NA

Connection Diagrams

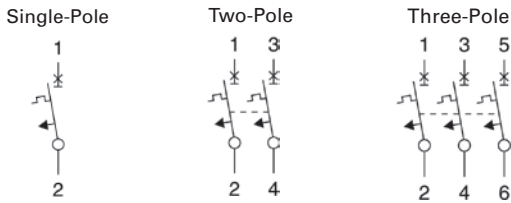

Miniature Circuit Breakers FAZ-NA

Description	
Electrical	
Design according to	UL 489, CSA C22.2 No.5, IEC 60947-2
Rated voltage FAZ-NA UL/CSA	10 kAIC at 277/480V from 0.5A to 32A 14 kAIC at select amperages B and C Curves (15–25A), D Curve (13–20A)
UL/CSA UL/CSA IEC 947-2	10 kAIC at 240 Vac for 35A and 40A 10 kAIC at 48 Vdc per pole 15 kAIC at 240/415 Vac
Rated voltage FAZ-NA-DC UL/CSA	10 kAIC at 125 Vdc per pole (two poles maximum) 10 kAIC at 250 Vdc with two poles connected in series
Rated frequency	50/60 Hz
Characteristic	B, C, D
Endurance	≥ 20,000 Operations
Line voltage connection	Suitable for reverse feed
Mechanical	
Frame size	45 mm
Device height	105 mm
Device width	17.7 mm per pole
Terminal protection	Finger and hand touch safe according to BGV A3, OVE-EN 6
Mounting	Quick fastening with two lock-in positions on IEC/EN 60715
Upper and lower terminals	Open mouth/lift terminals
Terminal capacity	One wire AWG 18–6 Two wires AWG 18–10
Terminal fastening torque	AWG 18-21: 21 lb-in AWG 10-8: 25 lb-in AWG 6: 36 lb-in
Mounting	Independent of position
Calibration temperature UL 489, CSA C22.2 No.5 IEC 60947-2	40°C 30°C

Dimensions

Miniature Circuit Breakers

FAZ-NA

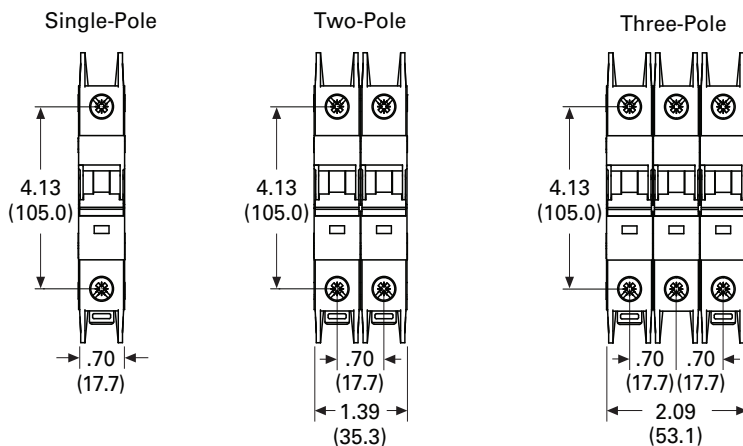

UL 489 DIN rail branch circuit breakers

FAZ-NA circuit breakers

TECHNICAL DATA

Let-through energy

Characteristic B (1–32A), 277V

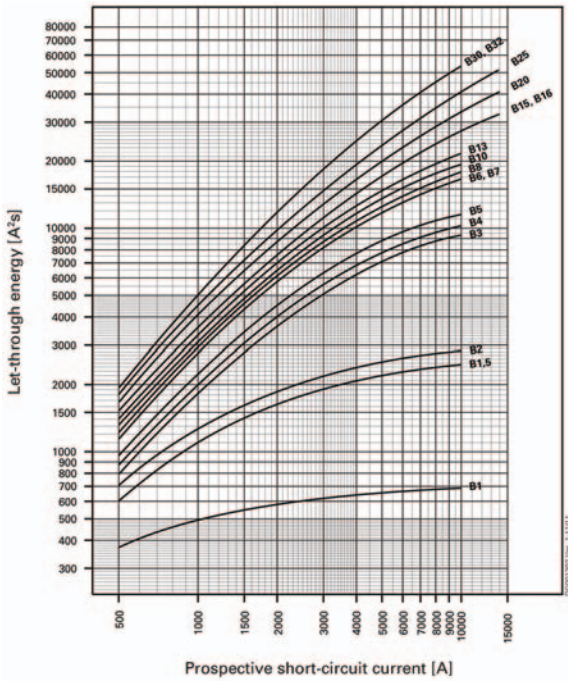

Characteristic B (35–40A), 240V

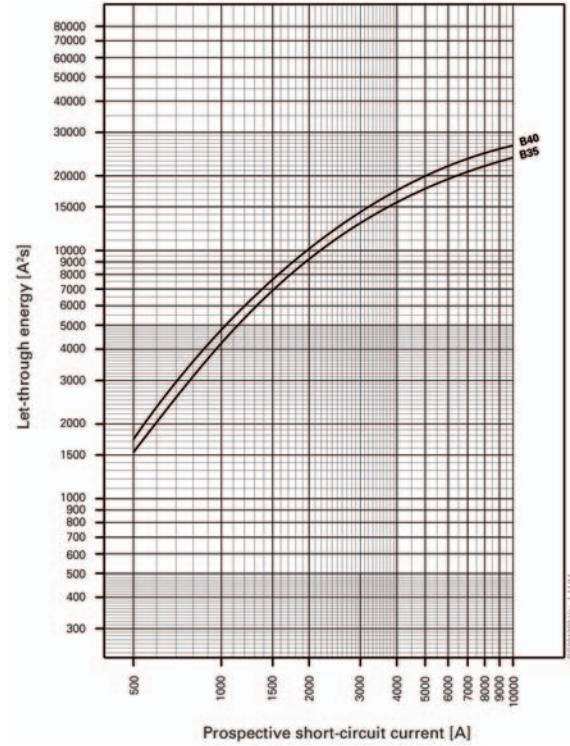

Characteristic C (0.5–32A), 277V

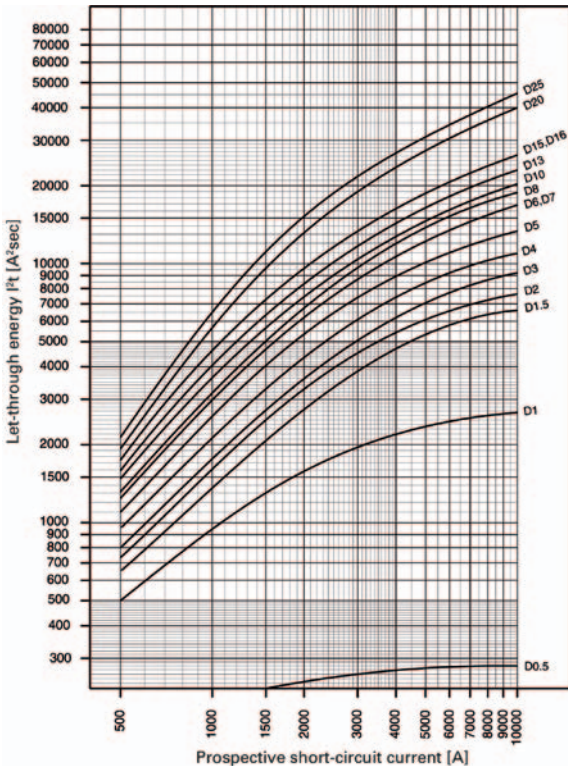

Characteristic C (40A), 240V

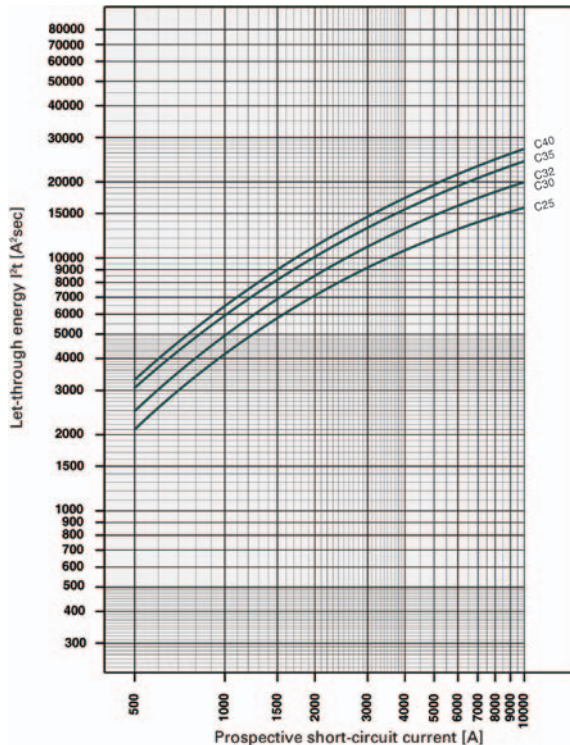

UL 489 DIN rail branch circuit breakers

FAZ-NA circuit breakers

TECHNICAL DATA

Characteristic D (0.5–32A), 277V

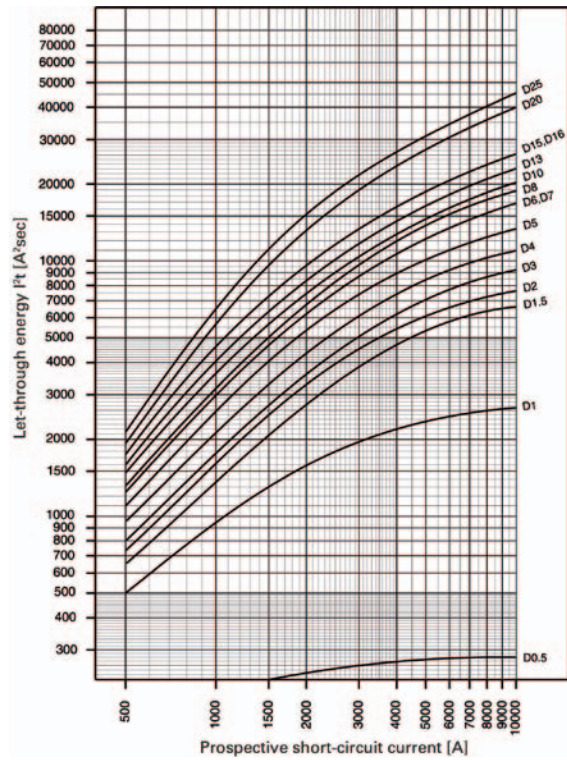

Characteristic D (40A), 240V

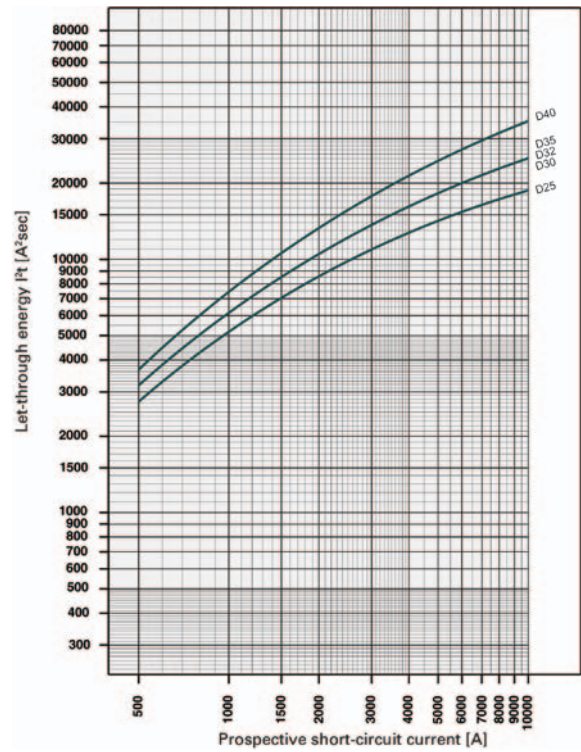

UL 489 DIN rail branch circuit breakers

FAZ-NA circuit breakers

TECHNICAL DATA

Influence of Ambient Temperature T on Load Carrying Capacity

Device Market Current Rating I_n (A) at 40°C	I_n (A) at Higher Ambient Temperature							
	15°C	20°C	25°C	30°C	40°C	50°C	55°C	60°C
0.5	0.6	0.5	0.5	0.5	0.5	0.5	0.5	0.5
1.0	1.1	1.1	1.1	1.0	1.0	1.0	0.9	0.9
1.5	1.7	1.6	1.6	1.6	1.5	1.4	1.4	1.4
2.0	2.2	2.2	2.1	2.1	2.0	1.9	1.9	1.8
3.0	3.3	3.2	3.2	3.1	3.0	2.9	2.9	2.8
4.0	4.4	4.3	4.2	4.2	4.0	3.8	3.8	3.7
5.0	5.5	5.4	5.3	5.2	5.0	4.8	4.7	4.6
6.0	6.6	6.5	6.4	6.2	6.0	5.8	5.6	5.5
7.0	7.7	7.6	7.4	7.3	7.0	6.7	6.6	6.4
8.0	8.8	8.6	8.5	8.3	8.0	7.7	7.5	7.4
10.0	11.0	10.8	10.6	10.4	10.0	9.6	9.4	9.2
13.0	14.3	14.0	13.8	13.5	13.0	12.5	12.5	12.0
15.0	16.5	16.2	15.9	15.6	15.0	14.4	14.1	13.8
16.0	17.6	17.3	17.0	16.6	16.0	15.4	15.0	14.7
20.0	22.0	21.6	21.2	20.8	20.0	19.2	18.8	18.4
25.0	27.5	27.0	26.5	26.0	25.0	24.0	23.3	23.0
30.0	33.0	32.4	31.8	31.2	30.0	28.8	28.2	27.6
32.0	35.2	34.6	33.9	33.3	32.0	30.7	30.1	29.4
40.0	44.0	43.2	42.4	41.6	40.0	38.4	37.6	36.8

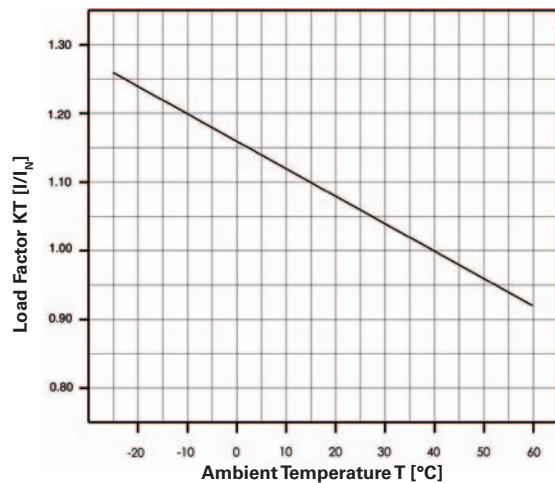

Maximum Load I_L at ambient temperature T: $I_L(T) = I_N K_T(T)$

Load Carrying Capacity of Adjoining Miniature Circuit Breakers

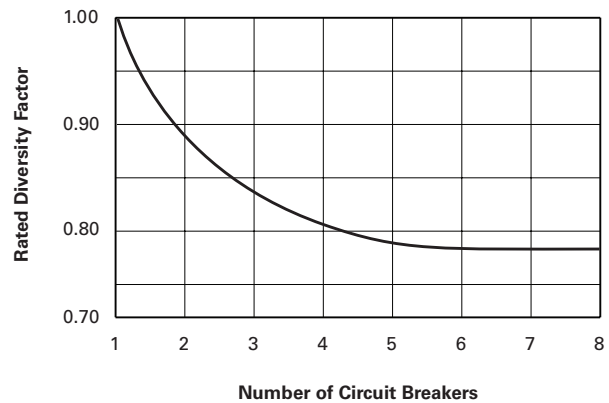

Power Loss at I_n

I_n [A]	Characteristic B			Characteristic C			Characteristic D		
	Single-pole P [W]	Two-pole P [W]	Three-pole P [W]	Single-pole P [W]	Two-pole P [W]	Three-pole P [W]	Single-pole P [W]	Two-pole P [W]	Three-pole P [W]
0.5	—	—	—	1.6	3.2	4.7	1.6	3.2	4.8
1	1.1	2.2	3.4	1.1	2.2	3.4	0.8	1.5	2.3
1.5	2.2	4.4	6.6	1.3	2.6	3.9	1.0	2.1	3.1
2	1.4	2.8	4.3	1.4	2.8	4.3	1.0	2.1	3.1
3	2.1	4.2	6.4	1.2	2.4	3.6	1.2	2.4	3.6
4	1.4	2.9	4.3	1.4	2.9	4.3	1.4	2.9	4.3
5	1.8	3.7	5.5	1.9	3.7	5.6	1.5	2.9	4.4
6	1.7	3.5	5.2	1.2	2.3	3.5	1.2	2.3	3.5
7	2.0	4.0	6.0	1.4	2.8	4.3	1.4	2.8	4.3
8	2.0	3.9	5.9	1.4	2.8	4.2	1.2	2.4	3.7
10	1.8	3.6	5.3	1.8	3.6	5.3	1.5	3.0	4.5
13	2.4	4.7	7.1	2.4	4.7	7.1	2.0	4.1	6.1
15	1.9	3.8	5.6	1.9	3.8	5.6	1.5	3.1	4.6
16	2.1	4.3	6.4	2.1	4.3	6.4	1.7	3.5	5.2
20	2.9	5.8	8.7	2.9	5.8	8.7	1.8	3.7	5.5
25	3.1	6.2	9.3	3.1	6.2	9.3	2.6	5.1	7.7
30	3.0	6.0	9.0	3.0	6.0	9.0	2.7	5.4	8.1
32	3.4	6.8	10.2	3.4	6.8	10.2	3.1	6.2	9.3
35	4.0	8.1	12.1	3.7	7.4	11.0	3.8	7.6	11.3
40	4.0	8.1	12.1	4.0	8.1	12.1	3.9	7.8	11.6

UL 489 DIN rail branch circuit breakers

FAZ-NA circuit breakers

ACCESSORY TECHNICAL DATA

Dimensions (mm)

Z-SV/UL-16/6

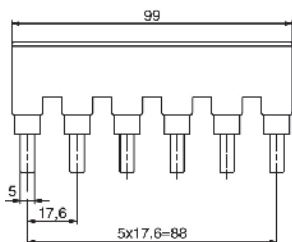

Z-SV/UL-18...12

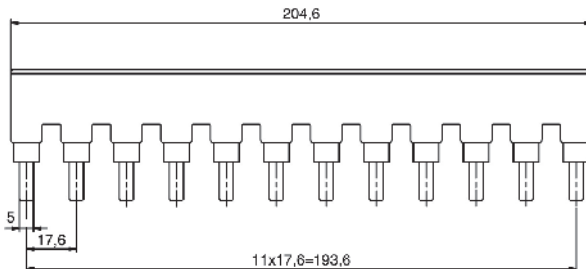

ZV-BS-UL

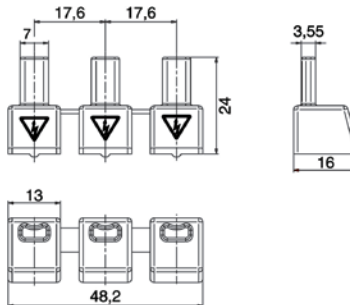

Z-SV/UL-16.../18

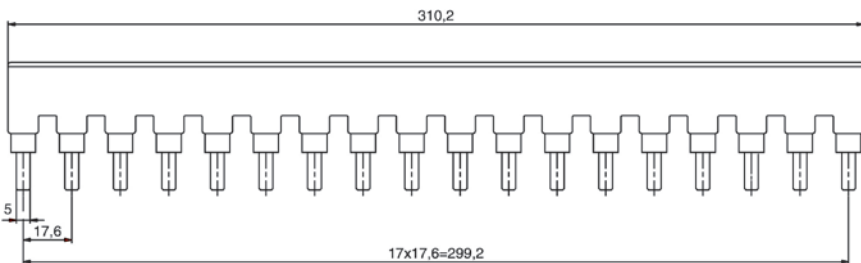

Z-EK/35/UL

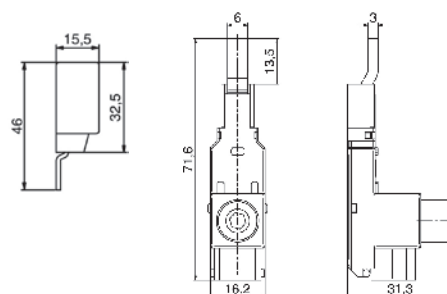

Z-EK/35/UL

Description	UL 489	IEC/EN 60947-2
U_e	480 Vac/96 Vdc	240/415 Vac
f	50/60 Hz	50/60 Hz
U_{imp}	—	9.5 kV
I_e	80A at 40°C	80A at 30°C
	#2-14 AWG 60/75°C Cu	2.5-35 mm ² Cu
	0.56 in	14 mm

Z-EB/50/UL

Description	UL 489	IEC/EN 60947-2
U_e	480 Vac/96 Vdc	240/415 Vac
f	50/60 Hz	50/60 Hz
U_{imp}	—	9.5 kV
I_e	115A at 40°C	160A at 30°C
	#1-14 AWG 60/75°C Cu	1.5-50 mm ² Cu
	0.56 in	14 mm

Lockout attachment IS/SPE-ITE

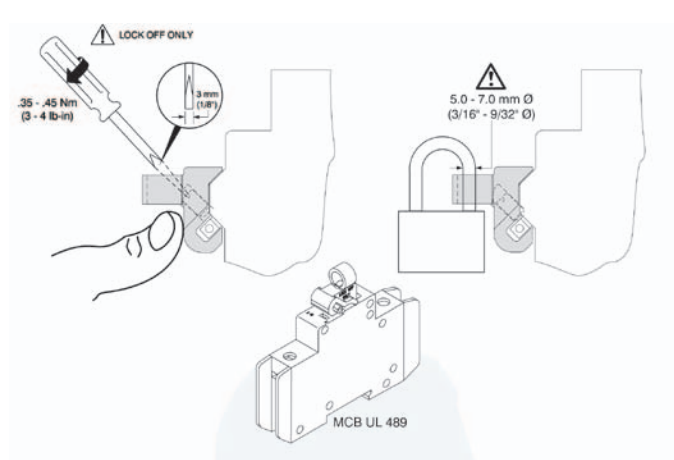

UL 489 DIN rail branch circuit breakers

FAZ-NA circuit breakers
ACCESSORY TECHNICAL DATA

Accessories



Description	Z-NHK	Z-IHK-NA
Electrical		
Contact function	2CO	1NO + 1NC
Rated voltage	230V	250V
Frequency	50/60 Hz	50/60 Hz
Rated current	2A	6A
Rated thermal current I_{th}	2A	6A
Utilization category AC13 Rated operational current I_e	3A/250 Vac	3A/250 Vac
Utilization category AC15 Rated operational current I_e	2A/250 Vac	2A/250 Vac
Utilization category DC12 Rated operational current I_e	0.5A/110 Vdc	0.5A/110 Vdc 0.25A/220 Vdc
Rated insulation voltage U_i	250 Vac	250 Vac
Minimum operational voltage per contact U_{min}	5 Vdc	5 Vdc
Minimum operational current I_{min}	10 mA DC	10 mA AC/DC
Rated peak withstand voltage U_{imp} (1.2/50 μ)	2.5 kV	4 kV
Conditional short-circuit current I_k with backup fuse 6A	1 kA	1 kA
Max. backup fuse, overload and short circuit	6A gL	—
Mechanical		
Tripping indicator "electrical tripping"	Blue/white	—
Frame size	45 mm	45 mm
Device height	80 mm	80 mm
Device width	8.8 mm (0.5MU)	8.8 mm (0.5MU)
Mounting	Onto switching device	—
Degree of protection, built-in	IP40	IP40
Terminal protection	Finger and hand touch safe According to BGV A3, ÖVE-EN 6	Finger and hand touch safe According to BGV A3, ÖVE-EN 6
Terminals	Lift terminals	Lift terminals
Terminal capacity	20–14 AWG	0.5–2.5 mm ²
Terminal screws	M3 (Posidrive Z0)	M3 (Posidrive Z0)
Fastening torque of terminal screws	7 lb-in	Max. 1.2 Nm

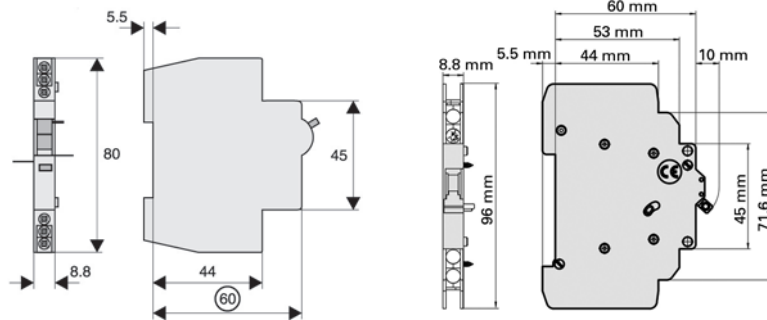

UL 489 DIN rail branch circuit breakers

FAZ-NA circuit breakers

ACCESSORY TECHNICAL DATA

Shunt trip release FAZ-XAA-NA

- Remote release for subsequent mounting onto FAZ-NA/RT
- Additional installation of standard auxiliary switch is possible
- Position indicator red–green

Connection Diagram

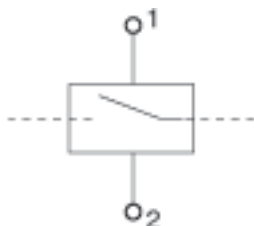

Shunt Trip Release FAZ-XAA-NA

Description	FAZ-XAA-NA12-110VAC	FAZ-XAA-NA110-415VAC
Electrical		
Can be mounted onto	FAZ-NA / FAZ-NA-DC / FAZ-RT	FAZ-NA / FAZ-NA-DC / FAZ-RT
Operational voltage range	12–110 Vac 12–60 Vdc	110–415 Vac 110–230 Vdc
Frequency	50/60 Hz	50/60 Hz
Mechanical		
Frame size	45 mm	45 mm
Device height	105 mm	105 mm
Device width	17.5 mm	17.5 mm
Mounting	Quick fastening with two lock-in positions on EN 50022	
Degree of protection, built-in	IP40	IP40
Terminal protection	Finger and hand touch safe according to BGV A3, ÖVE-EN 6	
Terminals	Open mouthed/lift	Open mouthed/lift
Terminal capacity One and two wires	18–10 AWG	18–10 AWG

Busbar block UL 489 (pin)

- Tested according to UL 489
- Do not cut
- Extension terminal 35 mm² Z-EK/35/UL for copper conductors
- Incoming terminal 50 mm² Z-EB/50/UL
- For covering of not used pins, use busbar tag shrouds ZV-BS-UL

Connection Diagram

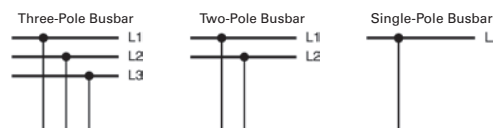

Busbar Block UL 489 (Pin)

Description	UL 489	IEC/EN 60947-2
Electrical		
Rated operational voltage	480/277 Vac 96 Vdc	—
Rated frequency	50/60 Hz	—
Rated voltage	480 Vac	690 Vac
Oversoltage category	—	III
Rated impulse withstand voltage U _{imp}	—	9.5 kV
Rated current	80A at 40°C	80A at 30°C
Rated conditional short-circuit current AC with 350A gG	—	15 kA
Short-circuit current	10 kA	—
Mechanical		
Busbar cross section	—	16 mm ² Cu
Flame class according to UL 94	V0	—
Pollution degree	—	2
Comparative tracking index	—	CTI 600
Minimum clearance (internal/external)	—	> 9.5/25.4 mm
Minimum creepage distance (internal/external)	—	> 12.7/50.8 mm
Resistance to climatic conditions	—	According to DIN/EN 60068

UL 1077 DIN rail supplementary protectors

FAZ circuit breakers

PRODUCT OVERVIEW

Optimum and efficient protection



Optimum product quality, tested reliability and safety stand for best protection of personnel, installations and plant. Eaton's FAZ DIN rail mountable circuit breaker is designed for use in control panel applications.

Powerful offering for machine and system builders

The FAZ is available with B, C, D, K, S, and Z characteristics in accordance with UL 1077, CSA C22.2 No.235 and IEC 60947-2. These devices are CE marked.

Typical applications

Supplementary protection

- Control circuits
- Lighting
- Business equipment
- Appliances

Features

- Complete range of UL 1077 recognized DIN rail mounted miniature circuit breakers up to 63A current rating
- Standard ratings of 10 kAIC up to 277/480 Vac
- Current limiting design provides fast short-circuit interruption that reduces the let-through energy, which can damage the circuit
- Suitable for supplementary protection
- Thermal-magnetic overcurrent protection
 - Six levels of short-circuit protection, categorized by B, C, D, K, S, and Z curves
- Trip-free design—breaker can not be defeated by holding the handle in the ON position
- Captive screws cannot be lost
- Fulfill UL 1077, CSA C22.2 No.235 and also IEC 60947-2 Standard
- Field-installable shunt trip and auxiliary switch subsequent mounting
- Module width of only 17.7 mm (per pole)
- Contact position indicator (red/green)
- Easy installation on DIN rail
- Possibility for sealing the toggle in ON or OFF position

FAZ complies with the latest national and international standards

Standards—Supplementary Protection

UL 1077, CSA C22.2 No. 235

Apply to supplementary protectors intended for use as overcurrent, or overvoltage or undervoltage protection within an appliance or other electrical equipment where branch circuit protection is already provided, or is not required.



RoHS

These devices are RoHS compliant.



VDE

Devices with B, C, and D curves are VDE compliant.



CCC

Devices with B, C, and D curves are CCC compliant.



ABS

These devices are ABS compliant.



UL 1077 DIN rail supplementary protectors

FAZ circuit breakers

PRODUCT OVERVIEW

Discover these advanced features

Breakers install on standard DIN rail

Available in one-, two-, three-, four-pole, 1+N and 3+N models

Color-coded indicator provides breaker status for easy troubleshooting



Captive Posidrive terminal screws with finger and back-of-hand protection (IP20)

Trip-free design; breaker cannot be defeated by holding the handle in the ON position

Breaker information printed on the front of the device for quick identification

Six tripping curves to choose from

Eaton FAZ supplementary protectors are available with six different tripping characteristics, including Type B, C, D, K, S, and Z. Definitions for each trip curve are contained on the ordering pages and can be used to determine the optimal characteristic for your application. For example, low-level short-circuit faults in control wiring, such as PLCs, are best protected by devices with Type B trip characteristics (3–5X continuous rating of the device (I_n)).

Even though not required by NEC or CEC for supplementary protectors, Eaton's FAZ devices are current limiting, which means that they interrupt fault currents within one half cycle. Current limiting devices offer superior protection by reducing peak let-through current and energy.

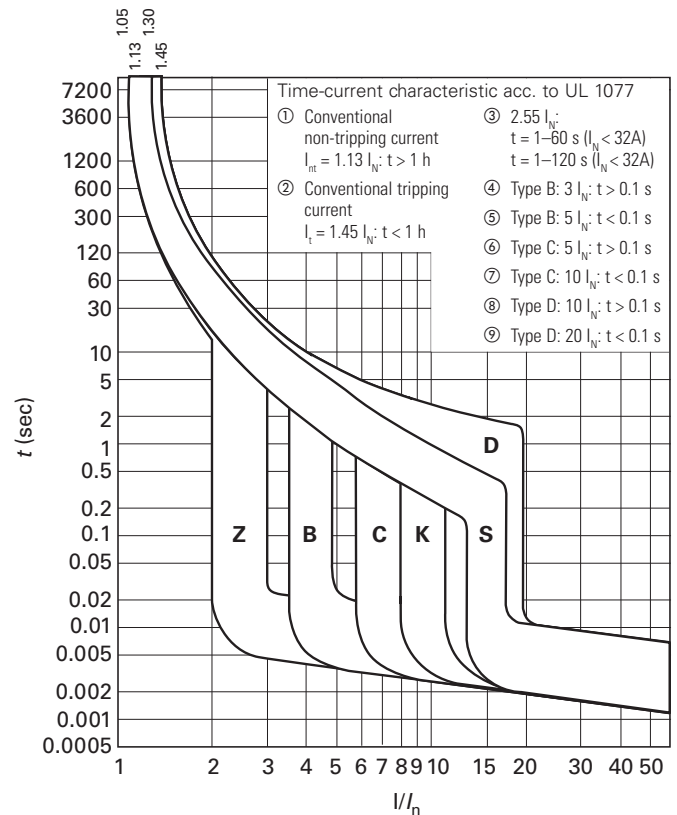

Catalog Numbering System

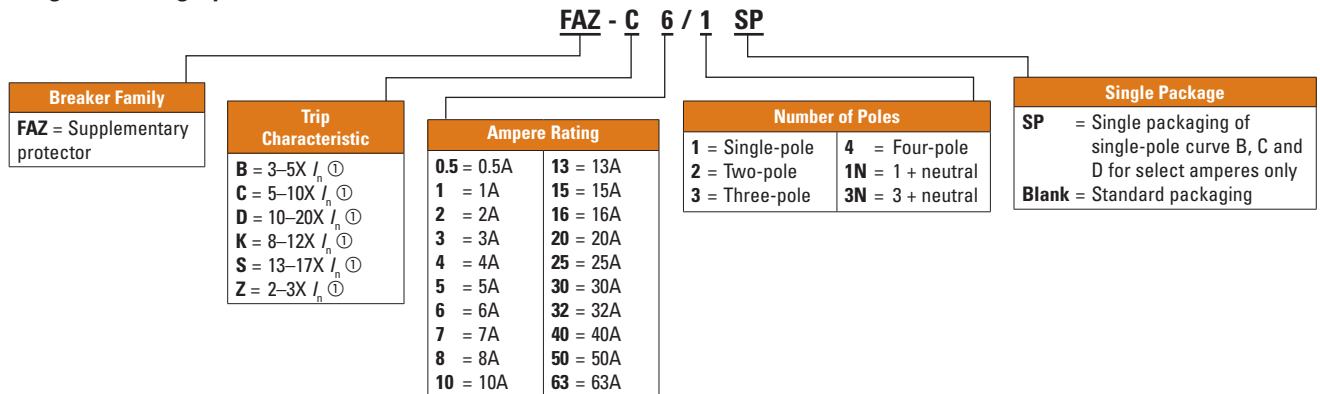

① I_n = Rated current for instantaneous trip characteristics.

UL 1077 DIN rail supplementary protectors

FAZ circuit breakers

PRODUCT SELECTION

FAZ product selection—B curve (3–5X I_n current rating)

- Designed for resistive or slightly inductive loads
- Response time of instantaneous trip: 3–5X I_n current rating
- UL recognized and CSA Certified as supplementary protectors
- For international and domestic use (conform to IEC 60947-2)
- UL file number 177451

Suitable for applications where protection against low-level short-circuit faults in control wiring is desired. Instantaneous trip is 3–5X continuous rating of device (I_n). Applications include PLC wiring, business equipment, lighting, appliances and some motors. Low magnetic trip point.

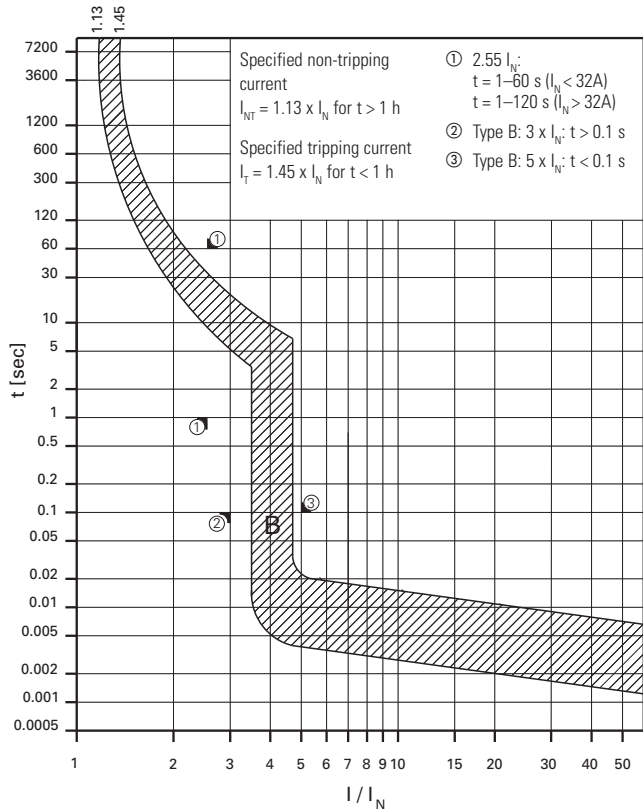

B Curve (3–5X I_n Current Rating)—designed for resistive or slightly inductive loads ①



	Single-pole ②	Two-pole	Three-pole	Four-pole	Single-pole + Neutral	Three-pole + Neutral
Amperes	Catalog Number	Catalog Number	Catalog Number	Catalog Number	Catalog Number	Catalog Number
1	FAZ-B1/1-SP	FAZ-B1/2	FAZ-B1/3	FAZ-B1/4	FAZ-B1/1N	FAZ-B1/3N
2	FAZ-B2/1-SP	FAZ-B2/2	FAZ-B2/3	FAZ-B2/4	FAZ-B2/1N	FAZ-B2/3N
3	FAZ-B3/1-SP	FAZ-B3/2	FAZ-B3/3	FAZ-B3/4	FAZ-B3/1N	FAZ-B3/3N
4	FAZ-B4/1-SP	FAZ-B4/2	FAZ-B4/3	FAZ-B4/4	FAZ-B4/1N	FAZ-B4/3N
5	FAZ-B5/1-SP	FAZ-B5/2	FAZ-B5/3	FAZ-B5/4	FAZ-B5/1N	FAZ-B5/3N
6	FAZ-B6/1-SP	FAZ-B6/2	FAZ-B6/3	FAZ-B6/4	FAZ-B6/1N	FAZ-B6/3N
7	FAZ-B7/1-SP	FAZ-B7/2	FAZ-B7/3	FAZ-B7/4	FAZ-B7/1N	FAZ-B7/3N
8	FAZ-B8/1-SP	FAZ-B8/2	FAZ-B8/3	FAZ-B8/4	FAZ-B8/1N	FAZ-B8/3N
10	FAZ-B10/1-SP	FAZ-B10/2	FAZ-B10/3	FAZ-B10/4	FAZ-B10/1N	FAZ-B10/3N
12	FAZ-B12/1-SP	FAZ-B12/2	FAZ-B12/3	FAZ-B12/4	FAZ-B12/1N	FAZ-B12/3N
13	FAZ-B13/1-SP	FAZ-B13/2	FAZ-B13/3	FAZ-B13/4	FAZ-B13/1N	FAZ-B13/3N
15	FAZ-B15/1-SP	FAZ-B15/2	FAZ-B15/3	FAZ-B15/4	FAZ-B15/1N	FAZ-B15/3N
16	FAZ-B16/1-SP	FAZ-B16/2	FAZ-B16/3	FAZ-B16/4	FAZ-B16/1N	FAZ-B16/3N
20	FAZ-B20/1-SP	FAZ-B20/2	FAZ-B20/3	FAZ-B20/4	FAZ-B20/1N	FAZ-B20/3N
25	FAZ-B25/1-SP	FAZ-B25/2	FAZ-B25/3	FAZ-B25/4	FAZ-B25/1N	FAZ-B25/3N
30	FAZ-B30/1-SP	FAZ-B30/2	FAZ-B30/3	FAZ-B30/4	FAZ-B30/1N	FAZ-B30/3N
32	FAZ-B32/1-SP	FAZ-B32/2	FAZ-B32/3	FAZ-B32/4	FAZ-B32/1N	FAZ-B32/3N
40	FAZ-B40/1-SP	FAZ-B40/2	FAZ-B40/3	FAZ-B40/4	FAZ-B40/1N	FAZ-B40/3N
50	FAZ-B50/1-SP	FAZ-B50/2	FAZ-B50/3	FAZ-B50/4	FAZ-B50/1N	FAZ-B50/3N
63	FAZ-B63/1-SP	FAZ-B63/2	FAZ-B63/3	FAZ-B63/4	FAZ-B63/1N	FAZ-B63/3N

① In North America, these switches are UL recognized and CSA Certified as supplementary protection devices. Per the intent of NEC (National Electrical Code), Article 240, and CEC (Canadian Electrical Code), Part 1 C22.1, supplementary breakers cannot be used as a substitute for the branch circuit protective device. They can be used to provide overcurrent protection within an appliance or other electrical equipment where branch circuit overcurrent protection is already provided, or is not required.

② Option for single packaging on single-pole B, C and D curves only; add suffix SP when ordering.

UL 1077 DIN rail supplementary protectors

FAZ circuit breakers

PRODUCT SELECTION

FAZ product selection—C curve (5–10X I_n current rating)

- Designed for inductive loads
- Response time of instantaneous trip: 5–10X I_n current rating
- UL recognized and CSA Certified as supplementary protectors
- For international and domestic use (conform to IEC 60947-2)
- UL file number 177451

Suitable for applications where medium levels of inrush current are expected. Instantaneous trip is 5–10X rating of device (I_n). Applications include small transformers, lighting, pilot devices, control circuits, and coils. Medium magnetic trip point.

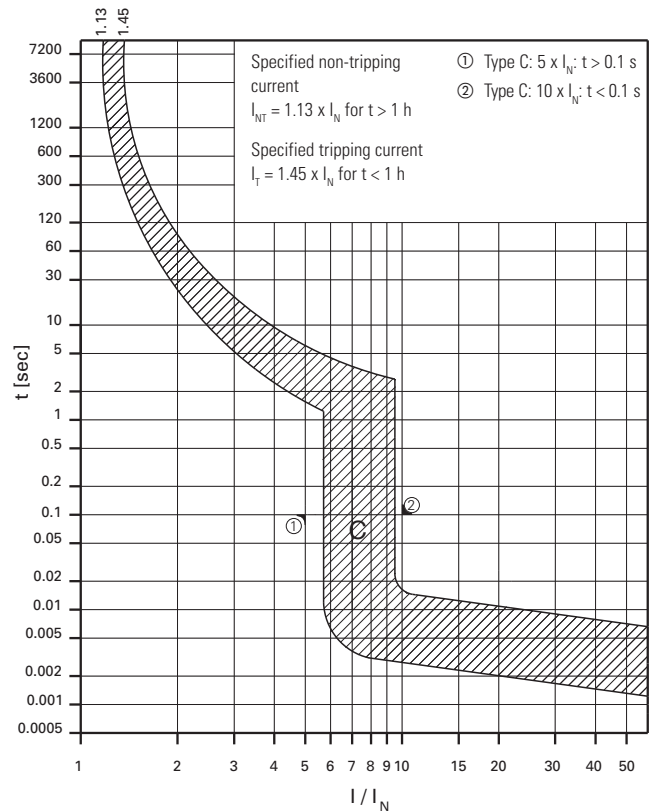

C Curve (5–10X I_n current rating)—designed for inductive loads ①



	Single-pole ②	Two-pole	Three-pole	Four-pole	Single-pole + Neutral	Three-pole + Neutral
Amperes	Catalog Number	Catalog Number	Catalog Number	Catalog Number	Catalog Number	Catalog Number
0.5	FAZ-C0.5/1-SP	FAZ-C0.5/2	FAZ-C0.5/3	FAZ-C0.5/4	FAZ-C0.5/1N	FAZ-C0.5/3N
1	FAZ-C1/1-SP	FAZ-C1/2	FAZ-C1/3	FAZ-C1/4	FAZ-C1/1N	FAZ-C1/3N
1.6	FAZ-C1.6/1-SP	FAZ-C1.6/2	FAZ-C1.6/3	FAZ-C1.6/4	FAZ-C1.6/1N	FAZ-C1.6/3N
2	FAZ-C2/1-SP	FAZ-C2/2	FAZ-C2/3	FAZ-C2/4	FAZ-C2/1N	FAZ-C2/3N
3	FAZ-C3/1-SP	FAZ-C3/2	FAZ-C3/3	FAZ-C3/4	FAZ-C3/1N	FAZ-C3/3N
4	FAZ-C4/1-SP	FAZ-C4/2	FAZ-C4/3	FAZ-C4/4	FAZ-C4/1N	FAZ-C4/3N
5	FAZ-C5/1-SP	FAZ-C5/2	FAZ-C5/3	FAZ-C5/4	FAZ-C5/1N	FAZ-C5/3N
6	FAZ-C6/1-SP	FAZ-C6/2	FAZ-C6/3	FAZ-C6/4	FAZ-C6/1N	FAZ-C6/3N
7	FAZ-C7/1-SP	FAZ-C7/2	FAZ-C7/3	FAZ-C7/4	FAZ-C7/1N	FAZ-C7/3N
8	FAZ-C8/1-SP	FAZ-C8/2	FAZ-C8/3	FAZ-C8/4	FAZ-C8/1N	FAZ-C8/3N
10	FAZ-C10/1-SP	FAZ-C10/2	FAZ-C10/3	FAZ-C10/4	FAZ-C10/1N	FAZ-C10/3N
13	FAZ-C13/1-SP	FAZ-C13/2	FAZ-C13/3	FAZ-C13/4	FAZ-C13/1N	FAZ-C13/3N
15	FAZ-C15/1-SP	FAZ-C15/2	FAZ-C15/3	FAZ-C15/4	FAZ-C15/1N	FAZ-C15/3N
16	FAZ-C16/1-SP	FAZ-C16/2	FAZ-C16/3	FAZ-C16/4	FAZ-C16/1N	FAZ-C16/3N
20	FAZ-C20/1-SP	FAZ-C20/2	FAZ-C20/3	FAZ-C20/4	FAZ-C20/1N	FAZ-C20/3N
25	FAZ-C25/1-SP	FAZ-C25/2	FAZ-C25/3	FAZ-C25/4	FAZ-C25/1N	FAZ-C25/3N
30	FAZ-C30/1-SP	FAZ-C30/2	FAZ-C30/3	FAZ-C30/4	FAZ-C30/1N	FAZ-C30/3N
32	FAZ-C32/1-SP	FAZ-C32/2	FAZ-C32/3	FAZ-C32/4	FAZ-C32/1N	FAZ-C32/3N
40	FAZ-C40/1-SP	FAZ-C40/2	FAZ-C40/3	FAZ-C40/4	FAZ-C40/1N	FAZ-C40/3N
50	FAZ-C50/1-SP	FAZ-C50/2	FAZ-C50/3	FAZ-C50/4	FAZ-C50/1N	FAZ-C50/3N
63	FAZ-C63/1-SP	FAZ-C63/2	FAZ-C63/3	FAZ-C63/4	FAZ-C63/1N	FAZ-C63/3N

① In North America, these switches are UL recognized and CSA Certified as supplementary protection devices. Per the intent of NEC (National Electrical Code), Article 240, and CEC (Canadian Electrical Code), Part 1 C22.1, supplementary breakers cannot be used as a substitute for the branch circuit protective device. They can be used to provide overcurrent protection within an appliance or other electrical equipment where branch circuit overcurrent protection is already provided, or is not required.

② Option for single packaging on single-pole B, C and D curves only; add suffix SP when ordering.

UL 1077 DIN rail supplementary protectors

FAZ circuit breakers

PRODUCT SELECTION

FAZ product selection—D curve (10–20X I_n current rating)

- Designed for highly inductive loads
- Response time of instantaneous trip: 10–20X I_n current rating
- UL recognized and CSA Certified as supplementary protectors
- For international and domestic use (conform to IEC 60947-2)
- UL file number 177451

Suitable for applications where high levels of inrush current are expected. Instantaneous trip is 10–20X rating of device (I_n). The high magnetic trip point prevents nuisance tripping in high inductive applications such as motors, transformers and power supplies.

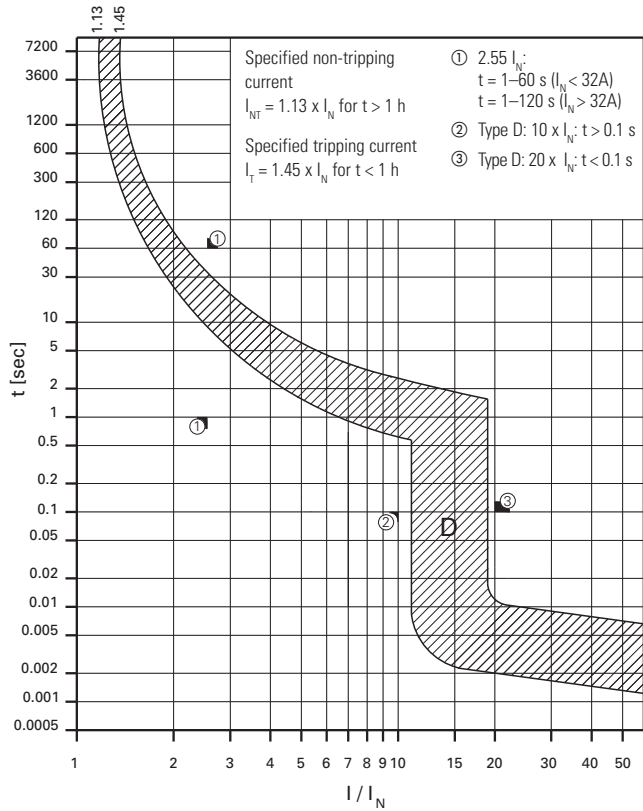

D Curve (10–20X I_n current rating)—designed for inductive loads ①



	Single-pole ②	Two-pole	Three-pole	Four-pole	Single-pole + Neutral	Three-pole + Neutral
Amperes	Catalog Number	Catalog Number	Catalog Number	Catalog Number	Catalog Number	Catalog Number
0.5	FAZ-D0.5/1-SP	FAZ-D0.5/2	FAZ-D0.5/3	FAZ-D0.5/4	FAZ-D0.5/1N	FAZ-D0.5/3N
1	FAZ-D1/1-SP	FAZ-D1/2	FAZ-D1/3	FAZ-D1/4	FAZ-D1/1N	FAZ-D1/3N
2	FAZ-D2/1-SP	FAZ-D2/2	FAZ-D2/3	FAZ-D2/4	FAZ-D2/1N	FAZ-D2/3N
3	FAZ-D3/1-SP	FAZ-D3/2	FAZ-D3/3	FAZ-D3/4	FAZ-D3/1N	FAZ-D3/3N
4	FAZ-D4/1-SP	FAZ-D4/2	FAZ-D4/3	FAZ-D4/4	FAZ-D4/1N	FAZ-D4/3N
5	FAZ-D5/1-SP	FAZ-D5/2	FAZ-D5/3	FAZ-D5/4	FAZ-D5/1N	FAZ-D5/3N
6	FAZ-D6/1-SP	FAZ-D6/2	FAZ-D6/3	FAZ-D6/4	FAZ-D6/1N	FAZ-D6/3N
7	FAZ-D7/1-SP	FAZ-D7/2	FAZ-D7/3	FAZ-D7/4	FAZ-D7/1N	FAZ-D7/3N
8	FAZ-D8/1-SP	FAZ-D8/2	FAZ-D8/3	FAZ-D8/4	FAZ-D8/1N	FAZ-D8/3N
10	FAZ-D10/1-SP	FAZ-D10/2	FAZ-D10/3	FAZ-D10/4	FAZ-D10/1N	FAZ-D10/3N
13	FAZ-D13/1-SP	FAZ-D13/2	FAZ-D13/3	FAZ-D13/4	FAZ-D13/1N	FAZ-D13/3N
15	FAZ-D15/1-SP	FAZ-D15/2	FAZ-D15/3	FAZ-D15/4	FAZ-D15/1N	FAZ-D15/3N
16	FAZ-D16/1-SP	FAZ-D16/2	FAZ-D16/3	FAZ-D16/4	FAZ-D16/1N	FAZ-D16/3N
20	FAZ-D20/1-SP	FAZ-D20/2	FAZ-D20/3	FAZ-D20/4	FAZ-D20/1N	FAZ-D20/3N
25	FAZ-D25/1-SP	FAZ-D25/2	FAZ-D25/3	FAZ-D25/4	FAZ-D25/1N	FAZ-D25/3N
30	FAZ-D30/1-SP	FAZ-D30/2	FAZ-D30/3	FAZ-D30/4	FAZ-D30/1N	FAZ-D30/3N
32	FAZ-D32/1-SP	FAZ-D32/2	FAZ-D32/3	FAZ-D32/4	FAZ-D32/1N	FAZ-D32/3N
40	FAZ-D40/1-SP	FAZ-D40/2	FAZ-D40/3	FAZ-D40/4	FAZ-D40/1N	FAZ-D40/3N
50 ③	FAZ-D50/1-SP	FAZ-D50/2	FAZ-D50/3	FAZ-D50/4	FAZ-D50/1N	FAZ-D50/3N
63 ③	FAZ-D63/1-SP	FAZ-D63/2	FAZ-D63/3	FAZ-D63/4	FAZ-D63/1N	FAZ-D63/3N

① In North America, these switches are UL recognized and CSA Certified as supplementary protection devices. Per the intent of NEC (National Electrical Code), Article 240, and CEC (Canadian Electrical Code), Part 1 C22.1, supplementary breakers cannot be used as a substitute for the branch circuit protective device. They can be used to provide overcurrent protection within an appliance or other electrical equipment where branch circuit overcurrent protection is already provided, or is not required.

② Option for single packaging on single-pole B, C and D curves only; add suffix SP when ordering.

③ IEC 60947-2 only.

UL 1077 DIN rail supplementary protectors

FAZ circuit breakers

PRODUCT SELECTION

FAZ product selection—K curve (8–12X I_n current rating)

- Designed for motors, transformers, and upstream electronics
- Response time of instantaneous trip: 8–12X I_n current rating
- UL recognized and CSA Certified as supplementary protectors
- For international and domestic use (conform to IEC 60947-2)
- UL file number 177451

Suitable for applications where medium levels of inrush current are expected. Instantaneous trip is 8–12X rating of device (I_n). Applications include small transformers, lighting, pilot devices, control circuits, and coils. Medium magnetic trip point.

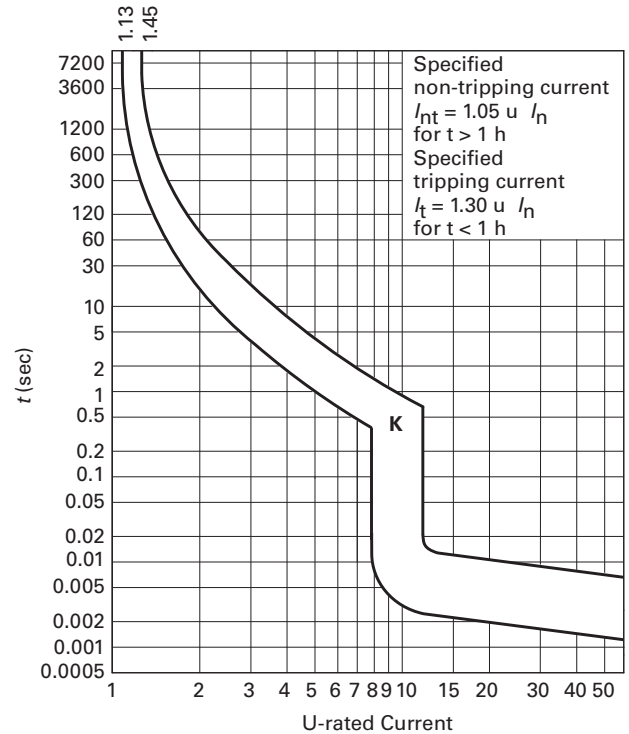

K Curve (8–12X I_n current rating)— designed for inductive loads ①②



	Single-pole ③	Two-pole	Three-pole	Four-pole	Single-pole + Neutral	Three-pole + Neutral
Amperes	Catalog Number	Catalog Number	Catalog Number	Catalog Number	Catalog Number	Catalog Number
0.5	FAZ-K0.5/1	FAZ-K0.5/2	FAZ-K0.5/3	FAZ-K0.5/4	FAZ-K0.5/1N	FAZ-K0.5/3N
1	FAZ-K1/1	FAZ-K1/2	FAZ-K1/3	FAZ-K1/4	FAZ-K1/1N	FAZ-K1/3N
1.6	FAZ-K1.6/1	FAZ-K1.6/2	FAZ-K1.6/3	FAZ-K1.6/4	FAZ-K1.6/1N	FAZ-K1.6/3N
2	FAZ-K2/1	FAZ-K2/2	FAZ-K2/3	FAZ-K2/4	FAZ-K2/1N	FAZ-K2/3N
3	FAZ-K3/1	FAZ-K3/2	FAZ-K3/3	FAZ-K3/4	FAZ-K3/1N	FAZ-K3/3N
4	FAZ-K4/1	FAZ-K4/2	FAZ-K4/3	FAZ-K4/4	FAZ-K4/1N	FAZ-K4/3N
6	FAZ-K6/1	FAZ-K6/2	FAZ-K6/3	FAZ-K6/4	FAZ-K6/1N	FAZ-K6/3N
8	FAZ-K8/1	FAZ-K8/2	FAZ-K8/3	FAZ-K8/4	FAZ-K8/1N	FAZ-K8/3N
10	FAZ-K10/1	FAZ-K10/2	FAZ-K10/3	FAZ-K10/4	FAZ-K10/1N	FAZ-K10/3N
13	FAZ-K13/1	FAZ-K13/2	FAZ-K13/3	FAZ-K13/4	FAZ-K13/1N	FAZ-K13/3N
16	FAZ-K16/1	FAZ-K16/2	FAZ-K16/3	FAZ-K16/4	FAZ-K16/1N	FAZ-K16/3N
20	FAZ-K20/1	FAZ-K20/2	FAZ-K20/3	FAZ-K20/4	FAZ-K20/1N	FAZ-K20/3N
25	FAZ-K25/1	FAZ-K25/2	FAZ-K25/3	FAZ-K25/4	FAZ-K25/1N	FAZ-K25/3N
32	FAZ-K32/1	FAZ-K32/2	FAZ-K32/3	FAZ-K32/4	FAZ-K32/1N	FAZ-K32/3N
40	FAZ-K40/1	FAZ-K40/2	FAZ-K40/3	FAZ-K40/4	FAZ-K40/1N	FAZ-K40/3N
50	FAZ-K50/1	FAZ-K50/2	FAZ-K50/3	FAZ-K50/4	FAZ-K50/1N	FAZ-K50/3N
63	FAZ-K63/1	FAZ-K63/2	FAZ-K63/3	FAZ-K63/4	FAZ-K63/1N	FAZ-K63/3N

① In North America, these switches are UL recognized and CSA Certified as supplementary protection devices. Per the intent of NEC (National Electrical Code), Article 240, and CEC (Canadian Electrical Code), Part 1 C22.1, supplementary breakers cannot be used as a substitute for the branch circuit protective device. They can be used to provide overcurrent protection within an appliance or other electrical equipment where branch circuit overcurrent protection is already provided, or is not required.

② These breakers are available by special order and may result in additional delivery time.

③ Two-piece box order, quantities of 2.

UL 1077 DIN rail supplementary protectors

FAZ circuit breakers

PRODUCT SELECTION

FAZ product selection—S curve (13–17X I_n current rating)

- Designed for control circuits with high inrush
- Response time of instantaneous trip: 13–17X I_n current rating
- UL recognized and CSA Certified as supplementary protectors
- For international and domestic use (conform to IEC 60947-2)
- UL file number 177451

Suitable for applications where high levels of inrush current are expected. Instantaneous trip is 13–17X rating of device (I_n). The high magnetic trip point prevents nuisance tripping in high inductive applications such as motors, transformers and power supplies.

S Curve (13–17X I_n current rating)— designed for inductive loads ①②



Amperes	Single-pole ③		Two-pole	
	Catalog Number	Catalog Number	Catalog Number	Catalog Number
1	FAZ-S1/1	FAZ-S1/2	FAZ-S1/1	FAZ-S1/2
2	FAZ-S2/1	FAZ-S2/2	FAZ-S2/1	FAZ-S2/2
3	FAZ-S3/1	FAZ-S3/2	FAZ-S3/1	FAZ-S3/2
4	FAZ-S4/1	FAZ-S4/2	FAZ-S4/1	FAZ-S4/2
6	FAZ-S6/1	FAZ-S6/2	FAZ-S6/1	FAZ-S6/2
10	FAZ-S10/1	FAZ-S10/2	FAZ-S10/1	FAZ-S10/2
16	FAZ-S16/1	FAZ-S16/2	FAZ-S16/1	FAZ-S16/2
20	FAZ-S20/1	FAZ-S20/2	FAZ-S20/1	FAZ-S20/2
25	FAZ-S25/1	FAZ-S25/2	FAZ-S25/1	FAZ-S25/2
32	FAZ-S32/1	FAZ-S32/2	FAZ-S32/1	FAZ-S32/2
40	FAZ-S40/1	FAZ-S40/2	FAZ-S40/1	FAZ-S40/2

① In North America, these switches are UL recognized and CSA Certified as supplementary protection devices. Per the intent of NEC (National Electrical Code), Article 240, and CEC (Canadian Electrical Code), Part 1 C22.1, supplementary breakers cannot be used as a substitute for the branch circuit protective device. They can be used to provide overcurrent protection within an appliance or other electrical equipment where branch circuit overcurrent protection is already provided, or is not required.

② These breakers are available by special order and may result in additional delivery time.

③ Two-piece box order, quantities of 2.

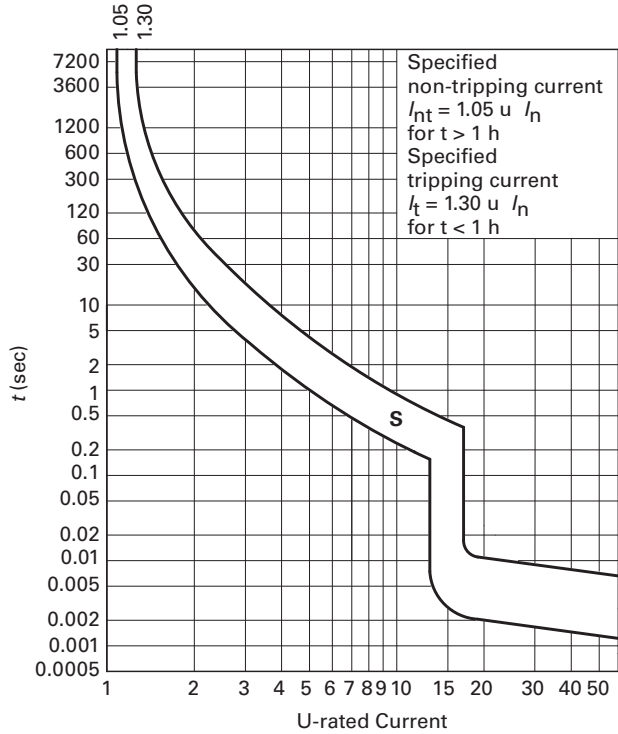

UL 1077 DIN rail supplementary protectors

FAZ circuit breakers

PRODUCT SELECTION

FAZ product selection—Z curve (2–3X I_n current rating)

- Designed for protection of electronic devices
- Response time of instantaneous trip: 2–3X I_n current rating
- UL recognized and CSA Certified as supplementary protectors
- For international and domestic use (conform to IEC 60947-2)

Suitable for applications where low levels of inrush current are expected. Instantaneous trip is 2–3X rating of device (I_n). Applications include small transformers, lighting, pilot devices, control circuits, and coils. Medium magnetic trip point.

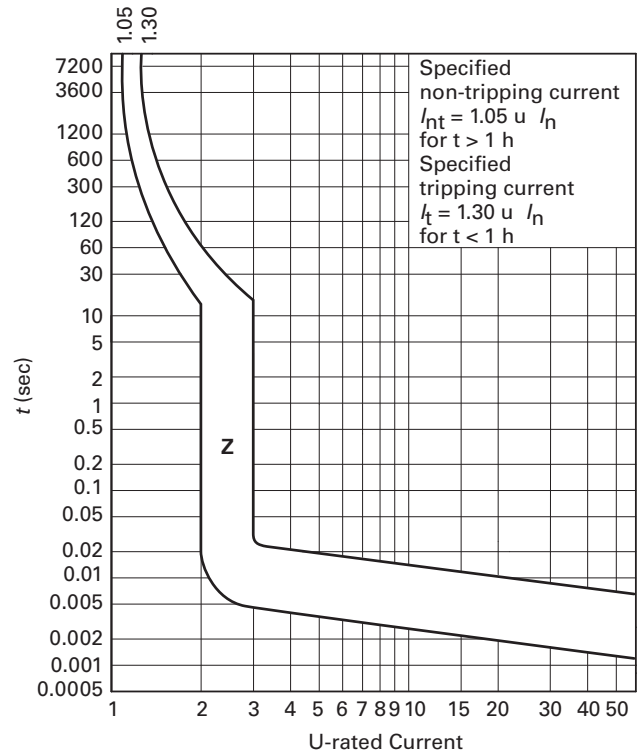

Z Curve (2–3X I_n current rating)— designed for inductive loads ①②



	Single-pole ③	Two-pole	Three-pole	Four-pole
Amperes	Catalog Number	Catalog Number	Catalog Number	Catalog Number
0.5	FAZ-Z0.5/1	FAZ-Z0.5/2	FAZ-Z0.5/3	FAZ-Z0.5/4
1	FAZ-Z1/1	FAZ-Z1/2	FAZ-Z1/3	FAZ-Z1/4
1.6	FAZ-Z1.6/1	FAZ-Z1.6/2	FAZ-Z1.6/3	FAZ-Z1.6/4
2	FAZ-Z2/1	FAZ-Z2/2	FAZ-Z2/3	FAZ-Z2/4
3	FAZ-Z3/1	FAZ-Z3/2	FAZ-Z3/3	FAZ-Z3/4
4	FAZ-Z4/1	FAZ-Z4/2	FAZ-Z4/3	FAZ-Z4/4
6	FAZ-Z6/1	FAZ-Z6/2	FAZ-Z6/3	FAZ-Z6/4
8	FAZ-Z8/1	FAZ-Z8/2	FAZ-Z8/3	FAZ-Z8/4
10	FAZ-Z10/1	FAZ-Z10/2	FAZ-Z10/3	FAZ-Z10/4
13	FAZ-Z13/1	FAZ-Z13/2	FAZ-Z13/3	FAZ-Z13/4
16	FAZ-Z16/1	FAZ-Z16/2	FAZ-Z16/3	FAZ-Z16/4
20	FAZ-Z20/1	FAZ-Z20/2	FAZ-Z20/3	FAZ-Z20/4
25	FAZ-Z25/1	FAZ-Z25/2	FAZ-Z25/3	FAZ-Z25/4
32	FAZ-Z32/1	FAZ-Z32/2	FAZ-Z32/3	FAZ-Z32/4
40	FAZ-Z40/1	FAZ-Z40/2	FAZ-Z40/3	FAZ-Z40/4
50	FAZ-Z50/1	FAZ-Z50/2	FAZ-Z50/3	FAZ-Z50/4
63	FAZ-Z63/1	FAZ-Z63/2	FAZ-Z63/3	FAZ-Z63/4

① In North America, these switches are UL recognized and CSA Certified as supplementary protection devices. Per the intent of NEC (National Electrical Code), Article 240, and CEC (Canadian Electrical Code), Part 1 C22.1, supplementary breakers cannot be used as a substitute for the branch circuit protective device. They can be used to provide overcurrent protection within an appliance or other electrical equipment where branch circuit overcurrent protection is already provided, or is not required.

② These breakers are available by special order and may result in additional delivery time.







③ Two-piece box order, quantities of 2.

UL 1077 DIN rail supplementary protectors

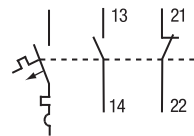
FAZ circuit breakers

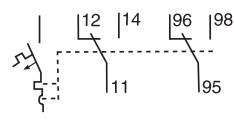
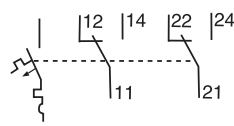
ACCESSORIES

Auxiliary Contacts and Voltage Trips

Module	Circuit Diagram	Description	Rated Operational Voltage	Catalog Number
Standard Auxiliary Contacts				
		<ul style="list-style-type: none"> • 1NO/1NC • Installs on left side of FAZ or shunt trip • Max. one per FAZ (1077) device • Switches when FAZ is tripped electrically or manually 	230 Vac	FAZ-XHIN11
		<ul style="list-style-type: none"> • 1 changeover contact • Installs on left side of FAZ or shunt trip • Max. one per FAZ (1077) device • Switches when FAZ is tripped electrically or manually 	230 Vac	FAZ-XHINW1
Auxiliary/Trip Indicating Contact				
	<p>Two-pole auxiliary mode</p>  <p>Trip indicating mode</p> 	<ul style="list-style-type: none"> • Small selector screw changes mode • Two Form C (changeover) contacts • Installs on left side of FAZ or shunt trip • Auxiliary contacts switch when FAZ is tripped electrically or manually • Trip indicating contact switches only when FAZ is tripped electrically 	230 Vac	FAZ-XAM002
Undervoltage Trip				
		<ul style="list-style-type: none"> • Prevents FAZ from operating unless voltage is present • Installs on left side of FAZ • Includes test button 	115 Vac 230 Vac 400 Vac	FAZ-XUA(115VAC) FAZ-XUA(230VAC) FAZ-XUA(400VAC)
Shunt Trip				
		<ul style="list-style-type: none"> • Allows remote trip of FAZ • Installs on left side of FAZ 	12–110 Vac 12–60 Vdc 110–415 Vac 110–230 Vdc	FAZ-XAA-C-12-110VAC FAZ-XAA-C-110-415VAC

Allowable Combinations of Accessories

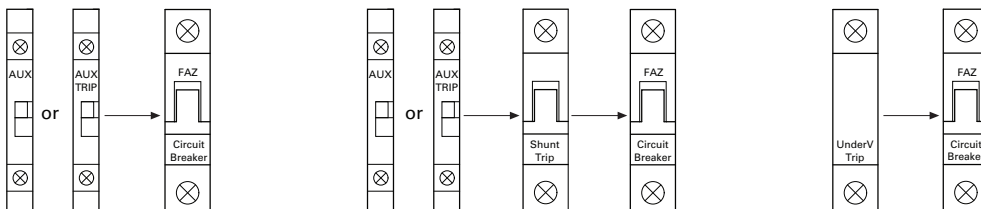

UL 1077 DIN rail supplementary protectors

FAZ circuit breakers

ACCESSORIES

Busbar System

Description	Rated Operational Current	Number of Poles per Device	Number of Terminals	Catalog Number ^①
Without Auxiliary Contacts For connecting FAZ supplementary protectors without auxiliary contacts. May be fed from line or load side.	80A	1	57	BB-UL-18/1P-1M/57
		2	56	BB-UL-18/2P-2M/56
		3	57	BB-UL-18/3P-3M/57
	100A	1	57	BB-UL-25/1P-1M/57
		2	56	BB-UL-25/2P-2M/56
		3	57	BB-UL-25/3P-3M/57
Auxiliary/Trip Indicating Contact For connecting FAZ supplementary protectors with auxiliary contacts. May be fed from line or load side.	80A	1	37	BB-UL-18/1P-1.5M/37
		2	46	BB-UL-18/2P+AS-2.5M/46
		3	48	BB-UL-18/3P+AS-3.5M/48
	100A	1	37	BB-UL-25/1P-1.5M/37
		2	46	BB-UL-25/2P+AS-2.5M/46
		3	48	BB-UL-25/3P+AS-3.5M/48

① Bus may be center fed for high current capacity.

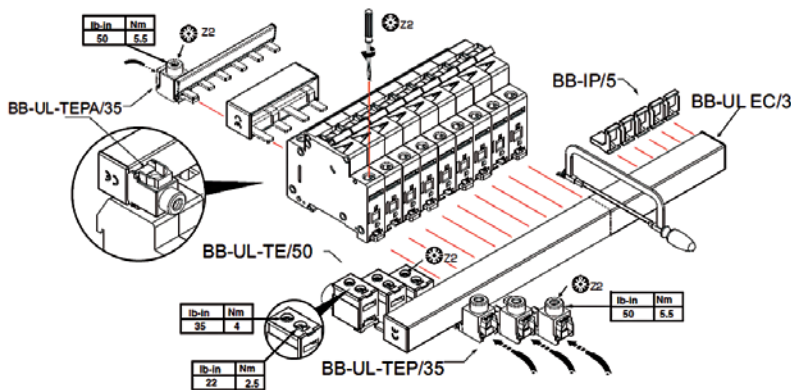

UL 1077 DIN rail supplementary protectors

FAZ circuit breakers

ACCESSORIES

Pin Type Incoming Supply Terminals

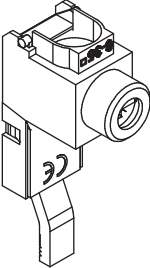
Accessories	Description	Installation	Catalog Number
	<ul style="list-style-type: none"> Accommodates conductors from 6–35 mm²/ #10–2 AWG 4–5.5 Nm/ 35–50 lb-in Two- and three-pole 		BB-UL-TEP/35

Pin Type Incoming Supply Terminals—Single-Phase Only

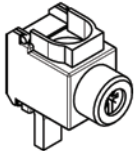
Accessories	Description	Poles	Catalog Number
	<ul style="list-style-type: none"> Accommodates conductors from 6–35 mm²/ #10–1/10 AWG 4–5.5 Nm/ 35–50 lb-in 		BB-UL-TEPA/35

Protective Accessories

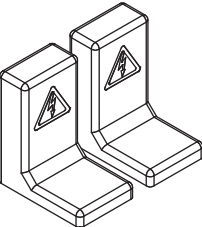
Accessories	Description	Catalog Number
	For covering unused terminals	BB-IP/5

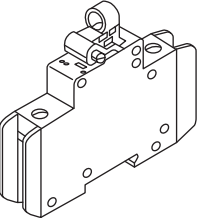

Padlock Hasp

	<ul style="list-style-type: none"> Prevents reactivation of the device during maintenance Holds one padlock 	IS/SPE-1TE
--	---	-------------------

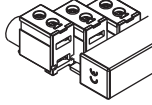
Bus Incoming Supply Terminals

Accessories	Description	Installation	Catalog Number
	<ul style="list-style-type: none"> 50 mm² #14–1 AWG 75 Deg wire 115 A/Y, 480V UL 160 A/Y 690V IEC 		BB-UL-TE/50

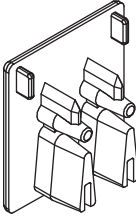
Busbar End Cap

Accessories	Description	Poles	Catalog Number
	<ul style="list-style-type: none"> Install after cutting busbar Protects end of busbar 	2 and 3	BB-UL-EC/3
		1	BB-UL-EC/1

UL 1077 DIN rail supplementary protectors

FAZ circuit breakers

TECHNICAL DATA

Technical Data

Description	B Curve	C Curve	D Curve
Electrical			
Approvals	UR (UL 1077), CSA (CSA 22.2 No. 235), CE		
Standards	IEC/EN 60947-2		
Short-circuit trip response	3–5 I_n	5–10 I_n	10–20 I_n
Supplementary Protectors—UL/CSA			
Current range	1–63A	0.5–63A	0.5–40A
Maximum voltage ratings—UL/CSA			
Single-pole, single-pole + neutral	277 Vac 48 Vdc	277 Vac 48 Vdc	277 Vac 48 Vdc
Two-, three-pole, four-pole and three-pole + neutral	480Y/277 Vac	480Y/277 Vac	480Y/277 Vac
Two poles in series	96 Vdc	96 Vdc	96 Vdc
Thermal tripping characteristics			
Single-pole	1.35 x I_n @ 40°C	1.35 x I_n @ 40°C	1.35 x I_n @ 40°C
Multi-pole	1.45 x I_n @ 40°C	1.45 x I_n @ 40°C	1.45 x I_n @ 40°C
Short-circuit ratings (at max. voltage)			
Single-pole	10 kA (5 kA for 40–63A device)	10 kA (5 kA for 40–63A device)	5 kA
Two-, three-pole	10 kA (5 kA for 40–63A device)	10 kA (5 kA for 40–63A device)	5 kA
Single-pole	10 kA @ 48 Vdc	10 kA @ 48 Vdc	10 kA @ 48 Vdc
Two poles in series	10 kA @ 96 Vdc	10 kA @ 96 Vdc	10 kA @ 96 Vdc
Miniature Circuit Breaker—IEC			
Current range	1–63A	0.5–63A	0.5–63A
Maximum voltage ratings—IEC 68898-1			
Single-pole	230 Vac	230 Vac	230 Vac
Two-, three-pole	230/400 Vac	230/400 Vac	230/400 Vac
Maximum voltage ratings—IEC 60947-2			
Single-pole	240 Vac 48 Vdc	240 Vac 48 Vdc	240 Vac 48 Vdc
Two-, three-pole	240/415 Vac	240/415 Vac	240/415 Vac
Two poles in series	96 Vdc	96 Vdc	96 Vdc
Thermal tripping characteristics			
Single-pole	> 1 hour @ 1.05 x I_n	> 1 hour @ 1.05 x I_n	> 1 hour @ 1.05 x I_n
Multi-pole	< 1 hour @ 1.3 x I_n	< 1 hour @ 1.3 x I_n	< 1 hour @ 1.3 x I_n
Interrupt ratings (at max. voltage)			
IEC 60947-2	15 kA	15 kA	15 kA (10 kA for 50 and 63A)
IEC 60898	10 kA	10 kA	10 kA (50 and 63A not available)
Operational switching capacity	7.5 kA	7.5 kA	7.5 kA
Max. backup fuse [gL/gG]	125A	125A	125A
Rated impulse withstand— U_{imp}	4000 Vac	4000 Vac	4000 Vac
Rated insulation voltage— U_i	440 Vac	440 Vac	440 Vac
Environmental/General			
Selectivity class	3	3	3
Lifespan (operations)	> 10,000 (1 operation = ON/OFF)	> 10,000 (1 operation = ON/OFF)	> 10,000 (1 operation = ON/OFF)
Shock (IEC 68-2-22)	10g–120 ms	10g–120 ms	10g–120 ms
Operating temperature range	–40 to +167°F (–40 to +75°C)	–40 to +167°F (–40 to +75°C)	–40 to +167°F (–40 to +75°C)
Shipment and short-term storage	–40 to +185°F (–40 to +85°C)	–40 to +185°F (–40 to +85°C)	–40 to +185°F (–40 to +85°C)
Housing material	Nylon	Nylon	Nylon
Mechanical			
Standard front dimension	80 mm	80 mm	80 mm
Device height	80 mm	80 mm	80 mm
Terminal protection	Finger and back-of-hand proof to IEC 536	Finger and back-of-hand proof to IEC 536	Finger and back-of-hand proof to IEC 536
Mounting width per pole	17.5 mm	17.5 mm	17.5 mm
Mounting	IEC/EN 60715 top-hat rail	IEC/EN 60715 top-hat rail	IEC/EN 60715 top-hat rail
Degree of protection	IP20	IP20	IP20
Terminals top and bottom	Twin-purpose terminals	Twin-purpose terminals	Twin-purpose terminals
Supply connection	Line or load side	Line or load side	Line or load side
Terminal capacity [mm ²]	1 x 25 (AWG 4–18)/2 x 10 (AWG 8–18)	1 x 25 (AWG 4–18)/2 x 10 (AWG 8–18)	1 x 25 (AWG 4–18)/2 x 10 (AWG 8–18)
Torque	2.4 Nm	2.4 Nm	2.4 Nm
Imperial torque	21 lb-in (AWG 18–12), 25 lb-in (AWG 10–8), 36 lb-in (AWG 6–4)	21 lb-in (AWG 18–12), 25 lb-in (AWG 10–8), 36 lb-in (AWG 6–4)	21 lb-in (AWG 18–12), 25 lb-in (AWG 10–8), 36 lb-in (AWG 6–4)
Thickness of busbar material	0.8–2 mm	0.8–2 mm	0.8–2 mm
Mounting position	As required	As required	As required

UL 1077 DIN rail supplementary protectors

FAZ circuit breakers

TECHNICAL DATA

Technical Data (continued)

Description	K Curve	S Curve	Z Curve
Electrical			
Approvals	UR (UL 1077), CSA (CSA 22.2 No. 235), CE		
Standards	IEC/EN 60947-2, E177451, 204453		
Short-circuit trip response	8–12 I_n	13–17 I_n	2–3 I_n
Supplementary Protectors—UL/CSA			
Current range	0.5–63A	0.5–40A	1–63A
Maximum voltage ratings—UL/CSA			
Single-pole, single-pole + neutral	277 Vac 48 Vdc	277 Vac 48 Vdc	277 Vac 48 Vdc
Two-, three-, four-pole and three-pole + neutral	480Y/277 Vac	480Y/277 Vac	480Y/277 Vac
Two poles in series	96 Vdc	96 Vdc	96 Vdc
Thermal tripping characteristics			
Single-pole	1.35 x I_n @ 40°C	1.35 x I_n @ 40°C	1.35 x I_n @ 40°C
Multi-pole	1.45 x I_n @ 40°C	1.45 x I_n @ 40°C	1.45 x I_n @ 40°C
Short-circuit ratings (at max. voltage)			
Single-pole	5 kA @ 277 Vac	5 kA @ 277 Vac	5 kA @ 277 Vac
Single-pole + neutral	5 kA @ 277 Vac	5 kA @ 277 Vac	5 kA @ 277 Vac
Two-, three-, four-pole	5 kA @ 480Y/277 Vac	5 kA @ 480Y/277 Vac	5 kA @ 480Y/277 Vac
Two poles in series	—	—	—
Miniature Circuit Breaker—IEC			
Current range	0.5–63A	0.5–40A	1–63A
Maximum voltage ratings—IEC 60947-2			
Single-pole, single-pole + neutral	240 Vac	240 Vac	240 Vac
Two-, three-, four-pole, three-pole + neutral	240/415 Vac	240/415 Vac	240/415 Vac
Thermal tripping characteristics			
Single-pole	> 1 Hour @ 1.05 x I_n	> 1 Hour @ 1.05 x I_n	> 1 Hour @ 1.05 x I_n
Multi-pole	< 1 Hour @ 1.3 x I_n	< 1 Hour @ 1.3 x I_n	< 1 Hour @ 1.3 x I_n
Interrupt ratings (at max. voltage)			
IEC 60947-2	15 kA	10 kA	10 kA
Operational switching capacity	7.5 kA	7.5 kA	7.5 kA
Max. backup fuse [gL/gG]	125A	125A	125A
Rated impulse withstand— U_{imp}	4000 Vac	4000 Vac	4000 Vac
Rated insulation voltage— U_i	440 Vac	440 Vac	440 Vac
Environmental/General			
Selectivity class	3	3	3
Lifespan (operations)	> 10,000 (1 operation = ON/OFF)	> 10,000 (1 operation = ON/OFF)	> 10,000 (1 operation = ON/OFF)
Shock (IEC 68-2-22)	10g–120 ms	10g–120 ms	10g–120 ms
Operating temperature range	–40 to +167°F (–40 to +75°C)	–40 to +167°F (–40 to +75°C)	–40 to +167°F (–40 to +75°C)
Shipment and short-term storage	–40 to +185°F (–40 to +85°C)	–40 to +185°F (–40 to +85°C)	–40 to +185°F (–40 to +85°C)
Housing material	Nylon	Nylon	Nylon
Mechanical			
Standard front dimension			
Device height	80 mm	80 mm	80 mm
Terminal protection	Finger and back-of-hand proof to IEC 536	Finger and back-of-hand proof to IEC 536	Finger and back-of-hand proof to IEC 536
Mounting width per pole	17.7 mm	17.7 mm	17.7 mm
Mounting	IEC/EN 60715 top-hat rail	IEC/EN 60715 top-hat rail	IEC/EN 60715 top-hat rail
Degree of protection	IP20	IP20	IP20
Terminals top and bottom	Twin-purpose terminals	Twin-purpose terminals	Twin-purpose terminals
Supply connection	Line or load side	Line or load side	Line or load side
Terminal capacity [mm ²]	1 x 25 (AWG 4–18) / 2 x 10 (AWG 8–18)	1 x 25 (AWG 4–18) / 2 x 10 (AWG 8–18)	1 x 25 (AWG 4–18) / 2 x 10 (AWG 8–18)
Torque	2.4 Nm	2.4 Nm	2.4 Nm
Imperial torque	21 lb-in (AWG 18–12), 25 lb-in (AWG 10–8), 36 lb-in (AWG 6–4)	21 lb-in (AWG 18–12), 25 lb-in (AWG 10–8), 36 lb-in (AWG 6–4)	21 lb-in (AWG 18–12), 25 lb-in (AWG 10–8), 36 lb-in (AWG 6–4)
Thickness of busbar material	0.8–2 mm	0.8–2 mm	0.8–2 mm
Mounting position	As required	As required	As required

UL 1077 DIN rail supplementary protectors

FAZ circuit breakers

TECHNICAL DATA

Let-through energy I^2t

Characteristic B and C

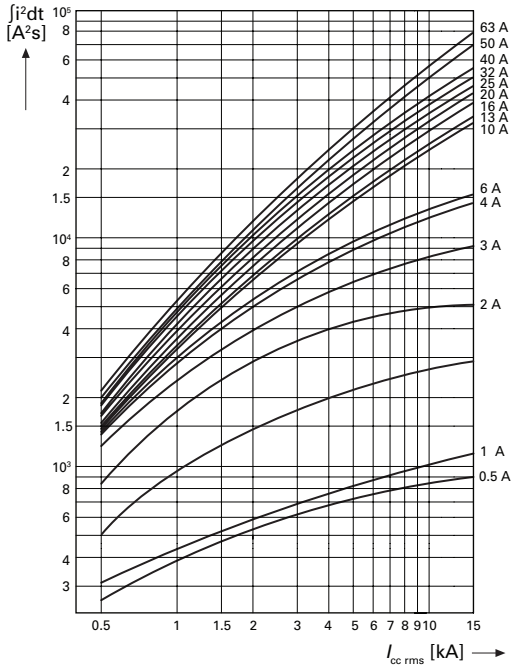

Let-through current I_D

Characteristic B and C

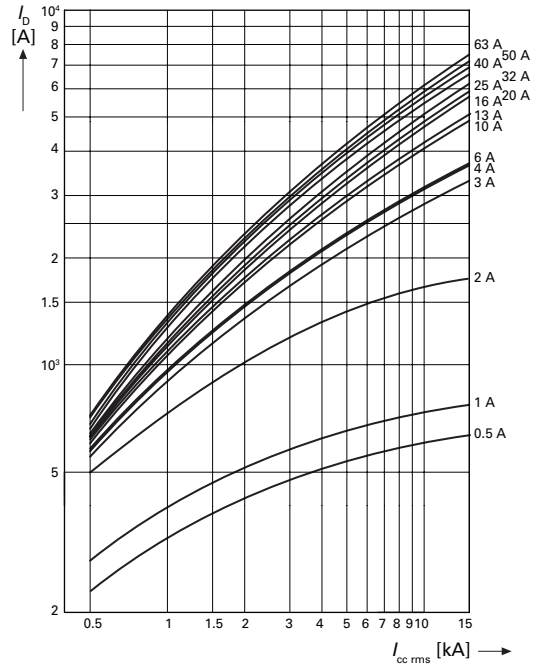

Characteristic D

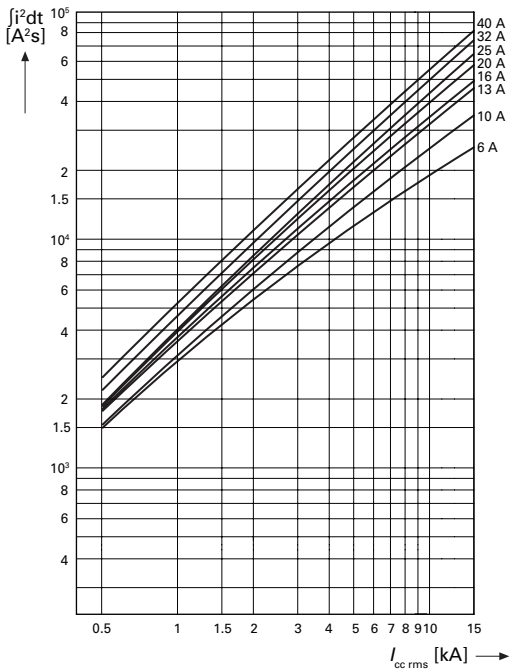

Characteristic D

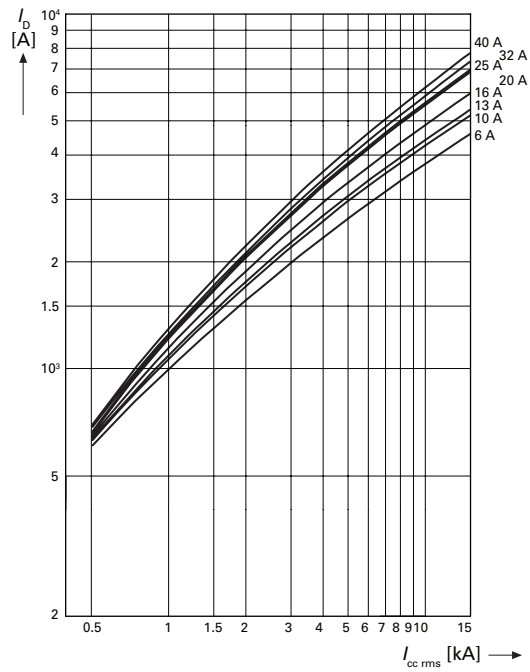

UL 1077 DIN rail supplementary protectors

FAZ circuit breakers

TECHNICAL DATA

Let-through energy I^2t

Characteristic K

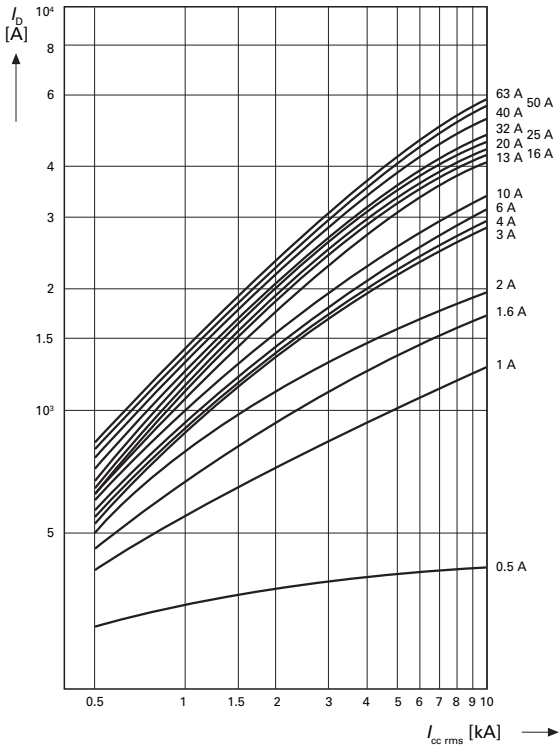

Characteristic S

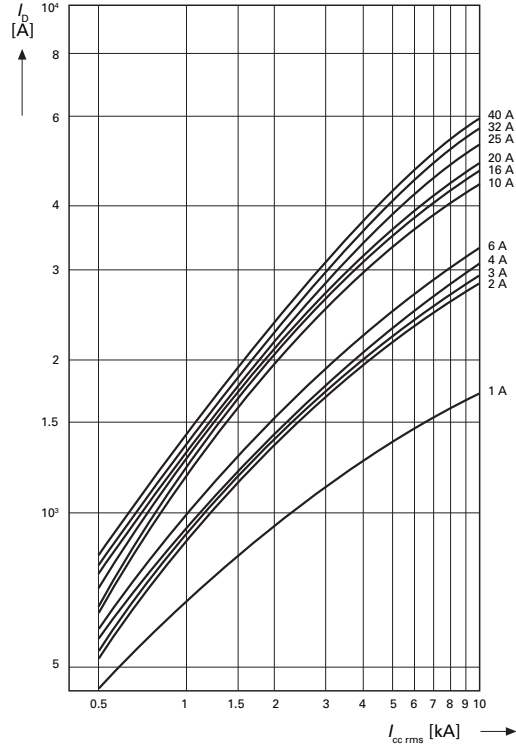

Characteristic Z

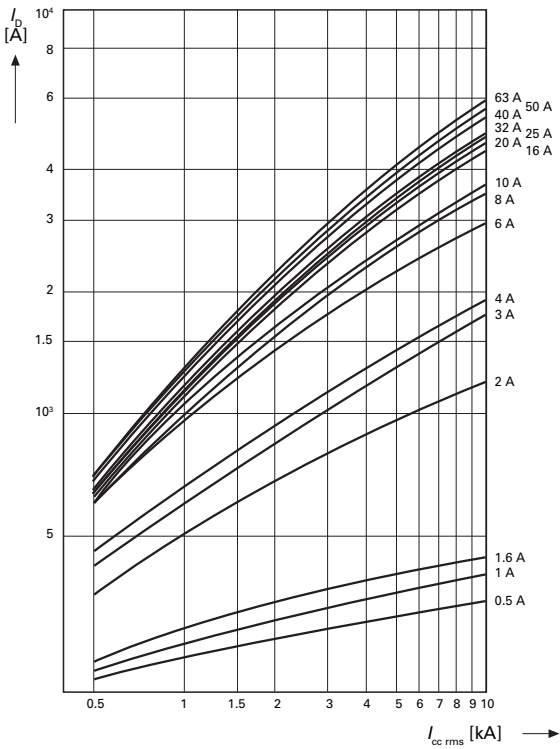

UL 1077 DIN rail supplementary protectors

FAZ circuit breakers

TECHNICAL DATA

Influence of the Ambient Temperature on the Thermal Tripping Behavior

Corrected values of the rated current dependent on the ambient temperature

I_n (A)	Ambient Temperature T																
	-40°C	-30°C	-20°C	-10°C	0°C	10°C	20°C	30°C	35°C	40°C	45°C	50°C	55°C	60°C	65°C	70°C	75°C
0.16	0.20	0.20	0.19	0.19	0.18	0.17	0.17	0.16	0.16	0.15	0.15	0.15	0.14	0.14	0.14	0.14	0.13
0.25	0.32	0.31	0.30	0.29	0.28	0.27	0.26	0.25	0.25	0.24	0.24	0.23	0.23	0.22	0.22	0.21	0.21
0.50	0.64	0.62	0.60	0.58	0.56	0.54	0.52	0.50	0.49	0.48	0.47	0.46	0.45	0.44	0.43	0.42	0.41
0.75	0.96	0.93	0.90	0.87	0.84	0.81	0.78	0.75	0.74	0.73	0.71	0.69	0.68	0.66	0.65	0.64	0.62
1.00	1.30	1.20	1.20	1.20	1.10	1.10	1.00	1.00	0.99	0.97	0.95	0.93	0.90	0.89	0.87	0.85	0.83
1.50	1.90	1.90	1.80	1.70	1.70	1.60	1.60	1.50	1.50	1.50	1.40	1.40	1.40	1.30	1.30	1.30	1.20
1.60	2.00	2.00	1.90	1.90	1.80	1.70	1.70	1.60	1.60	1.50	1.50	1.50	1.40	1.40	1.40	1.40	1.30
2.00	2.60	2.50	2.40	2.30	2.20	2.20	2.10	2.00	2.00	1.90	1.90	1.90	1.80	1.80	1.70	1.70	1.70
2.50	3.20	3.10	3.00	2.90	2.80	2.70	2.60	2.50	2.50	2.40	2.40	2.30	2.30	2.20	2.20	2.10	2.10
3.00	3.80	3.70	3.60	3.50	3.40	3.30	3.10	3.00	3.00	2.90	2.80	2.80	2.70	2.70	2.60	2.50	2.50
3.50	4.50	4.40	4.20	4.10	3.90	3.80	3.70	3.50	3.40	3.40	3.30	3.20	3.20	3.10	3.00	3.00	2.90
4.00	5.10	5.00	4.80	4.70	4.50	4.30	4.20	4.00	3.90	3.90	3.80	3.70	3.60	3.50	3.50	3.40	3.30
5.00	6.40	6.20	6.00	5.80	5.60	5.40	5.20	5.00	4.90	4.80	4.70	4.60	4.50	4.40	4.30	4.20	4.10
6.00	7.70	7.50	7.20	7.00	6.70	6.50	6.30	6.00	5.90	5.80	5.70	5.60	5.40	5.30	5.20	5.10	5.00
7.00	9.00	8.70	8.40	8.20	7.80	7.60	7.40	7.00	6.90	6.80	6.70	6.50	6.30	6.20	6.10	6.00	5.80
8.00	10.20	9.90	9.60	9.30	9.00	8.70	8.40	8.00	7.90	7.70	7.60	7.40	7.20	7.10	6.90	6.80	6.60
10.00	13.00	12.00	12.00	12.00	11.00	11.00	10.00	10.00	9.90	9.70	9.50	9.30	9.00	8.90	8.70	8.50	8.30
12.00	15.00	15.00	14.00	14.00	13.00	13.00	13.00	12.00	12.00	12.00	11.00	11.00	11.00	11.00	10.00	10.00	10.00
13.00	17.00	16.00	16.00	15.00	15.00	14.00	14.00	13.00	13.00	13.00	12.00	12.00	12.00	12.00	11.00	11.00	11.00
15.00	19.00	19.00	18.00	17.00	17.00	16.00	16.00	15.00	15.00	15.00	14.00	14.00	14.00	13.00	13.00	13.00	12.00
16.00	20.00	20.00	19.00	19.00	18.00	17.00	17.00	16.00	16.00	15.00	15.00	15.00	14.00	14.00	14.00	14.00	13.00
20.00	26.00	25.00	24.00	23.00	22.00	22.00	21.00	20.00	20.00	19.00	19.00	19.00	18.00	18.00	17.00	17.00	17.00
25.00	32.00	31.00	30.00	29.00	28.00	27.00	26.00	25.00	25.00	24.00	24.00	23.00	23.00	22.00	22.00	21.00	21.00
32.00	41.00	40.00	38.00	37.00	36.00	35.00	33.00	32.00	32.00	31.00	30.00	30.00	29.00	28.00	28.00	27.00	26.00
35.00	45.00	43.00	41.00	41.00	38.00	38.00	36.00	35.00	35.00	34.00	33.00	32.00	32.00	32.00	30.00	29.00	29.00
40.00	51.00	50.00	48.00	47.00	45.00	43.00	42.00	40.00	39.00	39.00	38.00	37.00	36.00	35.00	35.00	34.00	33.00
50.00	64.00	62.00	60.00	58.00	56.00	54.00	52.00	50.00	49.00	48.00	47.00	46.00	45.00	44.00	43.00	42.00	41.00
63.00	81.00	78.00	76.00	73.00	71.00	68.00	66.00	63.00	62.00	61.00	60.00	58.00	57.00	56.00	55.00	53.00	52.00

Influence of the Mains Frequency

Influence of the mains frequency on the tripping behavior I_{MA} of the instantaneous release

$I_{MA}(f)/I_{MA}(50\text{ Hz})$ [%]	Mains Frequency f [Hz]						
	16 2/3	50	60	100	200	300	400
	91	100	101	106	115	134	141

Load Carrying Capacity of Adjoining Miniature Circuit Breakers

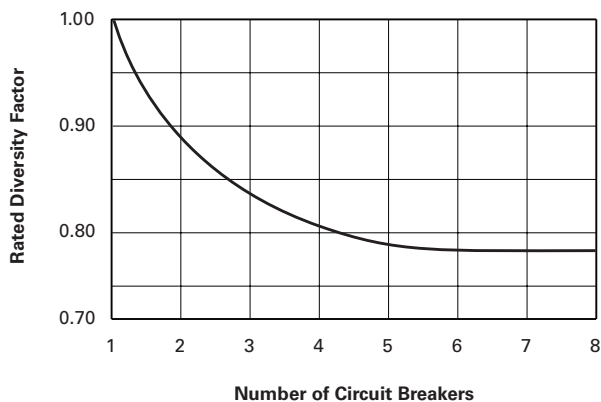

UL 1077 DIN rail supplementary protectors

FAZ circuit breakers

ACCESSORY TECHNICAL DATA

Technical Data

Description	FAZ-XHIN FAZ-XAM002	FAZ-XAA-C	FAZ-XUA
Electrical			
Contact function	1A + 1B 2 C/O	—	—
Rated operational voltage U_n	250 Vac	—	115 Vac 230 Vac 400 Vac
Voltage range	—	12–110 Vac 12–60 Vdc	—
Voltage range	—	110–415 Vac 110–230 Vdc	—
Closing threshold [x U_n]	—	—	0.8
Tripping threshold [x U_n]	—	—	0.5
Rated frequency f	50/60 Hz	50/60 Hz	50/60 Hz
General use (UL/CSA) AC—230/240 Vac DC—110/120 Vdc	2/2A 0.5/0.5A	—	—
Pilot duty	A600/Q600	—	—
Conventional free air thermal current I_{th}	4A	—	—
Rated operational current AC-13 I_p AC-15 I_p DC-13 I_p	3A (250 Vac) 2A (250 Vac) 0.5A (110 Vdc)	—	—
Rated insulation voltage U_i	250 Vac	—	—
Minimum operating voltage per contract U_{min}	5 Vdc	—	—
Rated impulse withstand voltage (1.2/50 μ) U_{imp}	2.5 kV	—	—
Rated conditional short-circuit current with 6A backup fuse I_{SC}	1 kA	—	—
Max. admissible backup fuse	4A gL	—	—
Mechanical			
Standard front dimension	45 mm	45 mm	45 mm
Device height	80 mm	80 mm	80 mm
Mounting width	8.8 mm	17.6 mm	17.8 mm
Mounting	On MCB	IEC/EN 60715 top-hat rail	IEC/EN 60715 top-hat rail
Degree of protection enclosed	IP40	IP40	IP40
Terminal protection	Protection against electric shock to IEC 536	Protection against electric shock to IEC 536	Protection against electric shock to IEC 536
Terminals	Lift terminals	Twin-purpose terminals	Twin-purpose terminals
Terminal capacity Solid Flexible	0.5–2.5 mm ² 0.5–2.5 mm ²	1–2.5 mm ² 1–2.5 mm ²	2 x (1–2.5) mm ² 2 x (1–2.5) mm ²
Tightening torque of terminal screws	0.8–1.0 Nm (7–9 lb-in)	2.4 Nm (21 lb-in)	0.8 Nm (7 lb-in)

UL 1077 DIN rail supplementary protectors

FAZ circuit breakers

ACCESSORY TECHNICAL DATA

Dimensions are in millimeters, and not intended for manufacturing purposes.

Miniature circuit breakers

FAZ

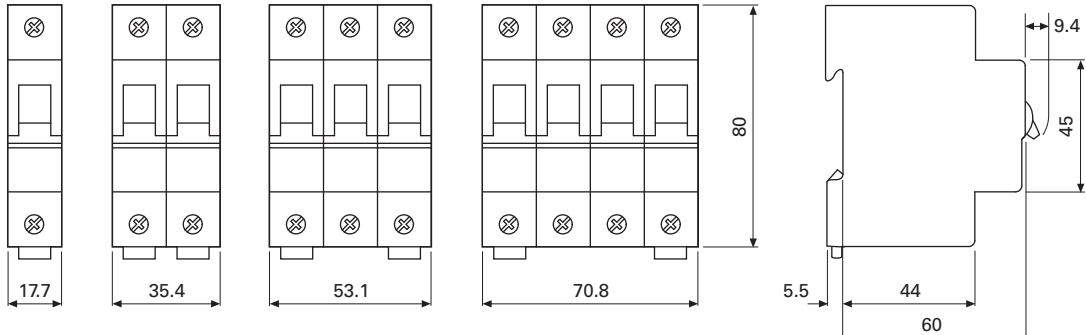

Auxiliary Contacts

FAZ-XHI11 and FAZ-XH1NW1

FAZ-XAM002

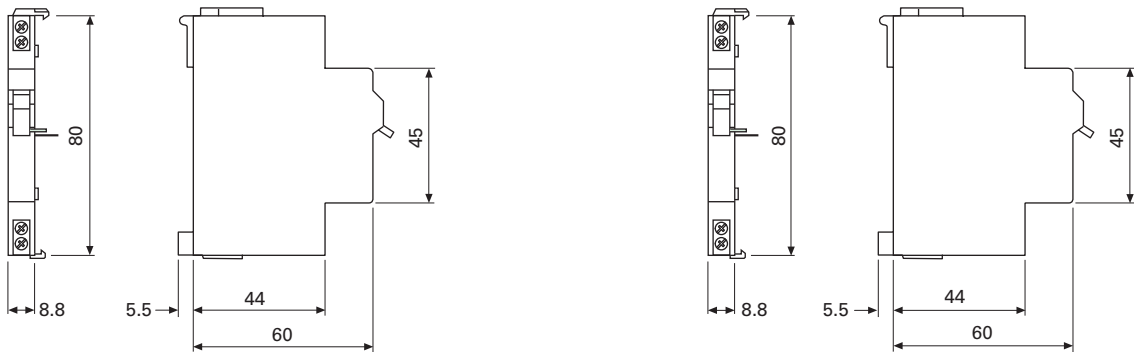

Shunt Releases

FAZ-XAA

Undervoltage Releases

FAZ-XUA

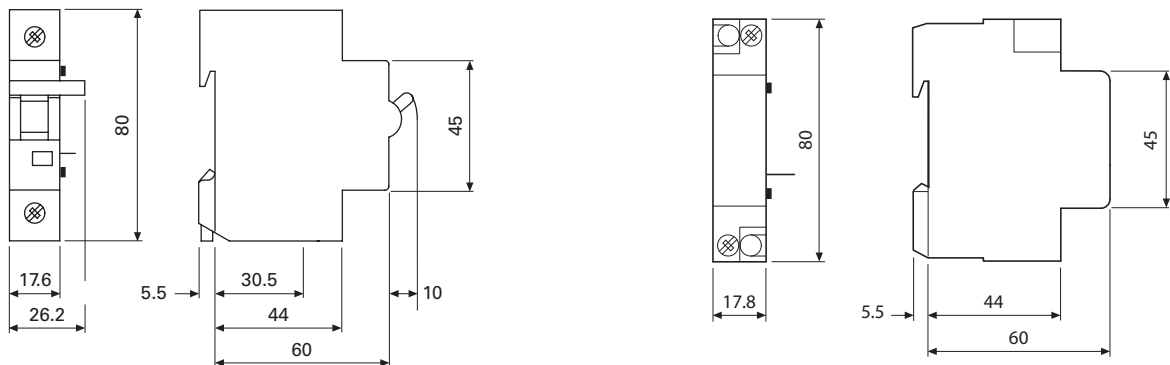

UL 1077 DIN rail supplementary protectors

FAZ circuit breakers

ACCESSORY TECHNICAL DATA

Busbar and Accessory Weights and Dimensions

Catalog Number	Unit Weight (kg)	Length (mm)	Width (mm)	Height (mm)
BB-UL-18/1P-1M/57	0.29	1009	15	15
BB-UL-18/2P-2M/56	0.64	991	22	37
BB-UL-18/3P-3M/57	0.83	1009	22	37
BB-UL-18/1P-1.5M/37	0.26	985	15	15
BB-UL-18/2P+AS-2.5M/46	0.63	1009	22	37
BB-UL-18/3P+AS-3.5M/48	0.79	982	22	37
BB-UL-25/1P-1M/57	0.36	1009	15	15
BB-UL-25/2P-2M/56	0.79	991	22	37
BB-UL-25/3P-3M/57	1.04	1009	22	37
BB-UL-25/1P-1.5M/37	0.31	985	15	15
BB-UL-25/2P+AS-2.5M/46	0.73	1009	22	37
BB-UL-25/3P+AS-3.5M/48	0.97	982	22	37
BB-UL-TEP/35	0.03	60	17	29
BB-UL-TEPA/35	0.03	36	17	29
BB-UL-TE/50	0.03	40	18	30
BB-IP/5	0.003	85	12	24
BB-UL-EC/3	0.001	14	5	10
BB-UL-EC/1	0.001	24	22	10

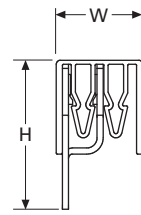
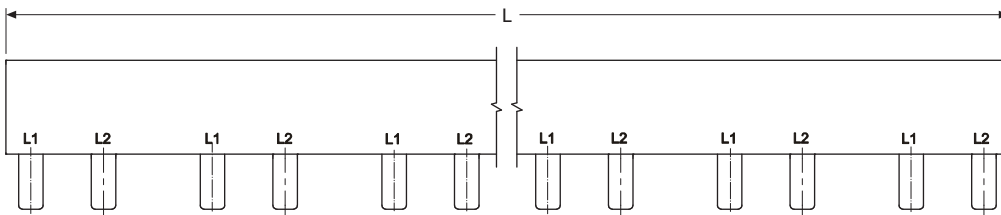

Application guidelines for UL 489 circuit breakers and UL 1077 supplementary protectors

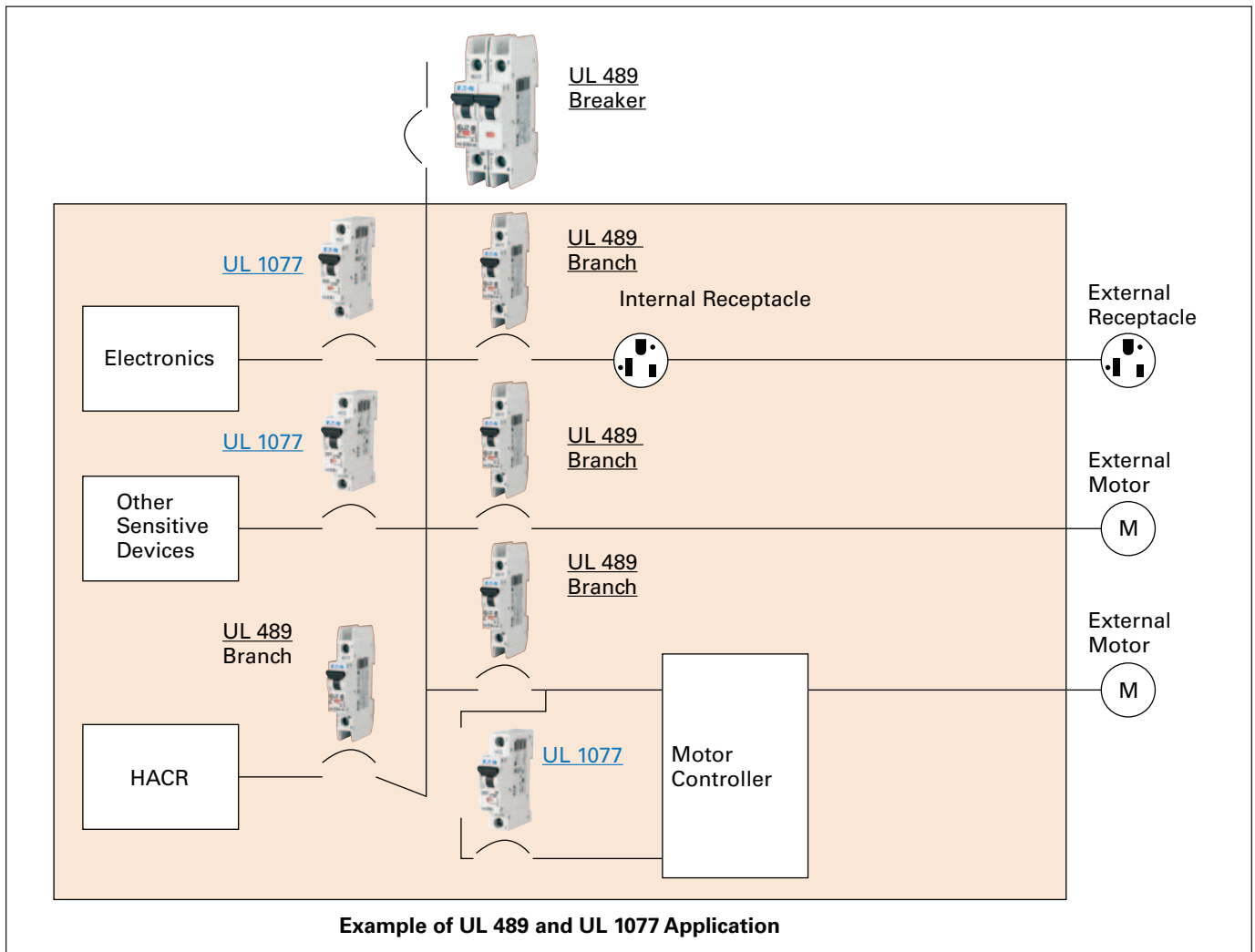

UL 489 circuit breakers

Used for branch circuit protection, internal/external receptacles, external motors and HACR equipment (heating, air conditioning and refrigeration).

UL 1077 supplementary protectors

Used for overcurrent protection within appliances or electrical equipment, where branch circuit protection is already provided or not required.

Note: UL 489 devices can be used in place of UL 1077; UL 1077 devices cannot be used in place of UL 489.

Miniature circuit breaker application

FAZ circuit breakers

PRODUCT OVERVIEW

Applying branch circuit breakers and supplementary protectors in North America



The Eaton series offer two types of miniature circuit breakers for use in North America. The first version, FAZ-NA(RT), fully complies with the molded-case circuit breaker standard UL 489 and the Canadian equivalent CSA 22.2 No. 5-09, which states that devices within that range can be applied legitimately as feeder and branch circuit protective devices per the U.S. and Canadian electrical codes.

A second version, FAZ, is recognized per UL 1077 and certified per CSA C22.2 No. 235 as a supplementary protector and can be fully used per the NEC and CEC Codes in that capacity. For international purposes, the entire FAZ family is CE marked and in full conformity with the applicable IEC standards for miniature circuit breakers, EN/IEC 60898 and EN/IEC 60947-2.

Both FAZ and FAZ-NA(RT) are offered in various ampere ranges and tripping characteristics. This paper will focus on the main technical aspects of the entire line and should assist in the proper selection and application of all versions.

Characteristics of IEC-style miniature circuit breakers

Because FAZ miniature circuit breakers are IEC-style devices, it is important to understand their inherent characteristics before examining them in the context of UL/CSA requirements.

- IEC-style miniature circuit breakers are thermal-magnetic, inverse time protective devices, with both a fixed thermal and a fixed magnetic trip setting
- They are toggle operated, and like all modern circuit breakers, feature a “trip-free” mechanism; this means that the tripping action works independently of the handle position for safety purposes
- They all mount on a standard 35 mm DIN rail and share a common single pole width of 17.5 mm
- Most comply with EN/IEC 60898 and EN/IEC 60947-2, which are the relevant international performance and testing standards for low voltage (<1000V) circuit breakers in Europe and the rest of the IEC world
- Outside North America, they can be used in both residential and industrial applications as feeder and branch circuit protective devices
- In North America, most European miniature circuit breakers are only UL recognized and CSA certified as “supplementary protectors,” meaning that they cannot be utilized as feeder or branch circuit protective devices per the local electrical codes. This commonly restricts their use to applications where “closer” protection is desired than that offered by a branch circuit protection device
- Some variations, like the FAZ-NA(RT) line have been specially designed to meet UL and CSA requirements for molded-case circuit breakers and are marked accordingly. This makes them suitable for feeder and branch circuit protection applications in North America

Miniature circuit breaker application

FAZ circuit breakers

PRODUCT OVERVIEW

Supplementary protectors

As mentioned, the standard FAZ line fulfills all of the criteria per code of “supplementary overcurrent protective devices,” or “supplementary protectors,” as they are better known.

What is the definition of a supplementary protector per North American standards?

A supplementary protector is a manual reset device designed to open the circuit automatically on a predetermined value of time versus current or voltage within an appliance or other electrical equipment. It may also be provided with manual means for opening or closing the circuit. (Source: UL 1077)

In the United States (and similarly in Canada) the NEC 2005 further defines supplementary protectors as devices intended to provide limited overcurrent protection for specific applications, such as lighting fixtures and appliances. This limited protection is in addition to the protection provided in the required branch circuit by the branch circuit overcurrent protective device.

Clearly, the underlying message in those definitions is that supplementary protectors are not branch circuit overcurrent protective devices per code, and neither are they tested that way per UL and CSA standards. They cannot replace the primary protective role performed by listed and certified molded case circuit breakers and fuses.

That explains, in part, their status by UL as “recognized only” devices. Supplementary protectors will never bear a UL listing mark, simply because their suitability as protective devices is dependent on a number of acceptability conditions that can vary from make to make and ultimately define the manner in which they can be properly applied per code. The manufacturer should be consulted in all cases when evaluating the suitability of “recognized only” components such as UL 1077 supplementary protectors.

FAZ protectors are not subject to any specific restrictions in this respect, other than, like all supplementary protectors, they must never be used as a substitute for true listed and certified primary overcurrent protective devices.

Where can supplementary protectors be used effectively per code standards?

Eaton series FAZ supplementary protectors can be used in a number of significant areas. To more clearly illustrate potential applications, however, let's first present the NEC's definition of a branch circuit:

The circuit conductors between the final overcurrent device protecting the circuit and the outlets. (Source: NEC)

A branch circuit is that portion of the electrical distribution system that extends beyond the final branch circuit overcurrent protective device and is intended to serve lighting, appliance, motors, and/or other individual loads.

Typically, the branch circuit overcurrent protective device (BOPD) will be either a listed molded-case circuit breaker or a fuse. Supplementary protectors, such as FAZ devices from the Eaton series, can therefore be added to any of these branch circuits to “supplement” the branch circuit protection. Examples of applications ideally suited for these devices can include:

- Any type of OEM electrical equipment that is fed from a service panel board and that often requires additional protection for sensitive internal circuitry and components (test and medical equipment, copiers and printers, computers and power supplies, etc.)
- The need for manual reset devices with optional accessories such as auxiliary contacts and voltage trips to accomplish fuseless protective circuit designs and enhance operational diagnostics
- Isolation and protection of control cable, coils, contacts, and circuit elements of motor control circuits tapped from the load side of the branch circuit protective device (per NEC 430.72)
- Protection of control circuit transformers, especially in the secondary where the manual reset protector can be used to isolate, as well as protect, secondary circuit conductors and loads

IEC-based miniature circuit breakers, such as the entire FAZ line, are much more than just conventional supplementary protectors from an internal design point of view and can provide an ideal means to enhance the protective capabilities of any circuit.

- As mentioned, they are in full compliance with the pertinent EN/IEC standards (EN/IEC 60898, EN/IEC 60947-2) for miniature circuit breakers and can thus be applied, outside of North America, as full-fledged stand-alone overcurrent protective devices in both residential and industrial applications
- As this typical let-through current curve shows, they are highly current limiting devices that appreciably limit the amount of let-through current and destructive energy within their ratings to minimize damage levels to downstream loads and circuits

Circuit breakers that are classified as “current limiting” have the ability to clear damaging short-circuit currents within the first half-cycle of the fault, resulting in better overall protection for all circuit components.

- They come in a variety of tripping characteristics, which is ideal when customizing protection to match specific load requirements. FAZ supplementary protectors offer a total of six different protection characteristics for this purpose: B, C, D, K, S, and Z tripping characteristics
- They feature a number of electrical accessories to enhance the performance and diagnostic capabilities of control panels, as well as a means to facilitate panel mounting and wiring

Miniature circuit breaker application

FAZ circuit breakers

PRODUCT OVERVIEW

Typical let-through curve profile of a current-limiting device

- The X axis shows the prospective short-circuit current levels
- The Y axis indicates the actual let-through values (let-through current in the example shown) at those prospective fault ratings for each FAZ device plotted

As can be interpreted from the bend in the plotted curves, each device acts to limit the damaging let-through energy (and current) at those values of short-circuit current.

By design, all Eaton series FAZ supplementary protectors and miniature molded-case circuit breakers are current-limiting protective devices.

Characteristic B and C

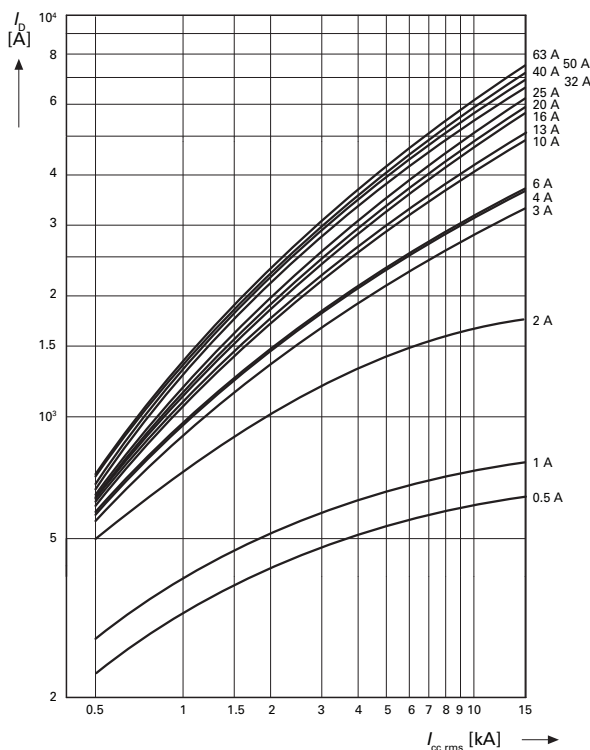

Tripping characteristics

Miniature circuit breakers are thermal-magnetic, inverse-time tripping devices. From a thermal point of view, all FAZ protectors are calibrated to trip at the same level, which is 135% of the device's fixed current rating for single-pole and 145% for multi-pole at an ambient reference temperature of 40°C.

Note: Higher ambient temperatures, as well as density of mounting groups, can all be accommodated but may be subject to de-rating factors. Please consult technical data for further information and appropriate curves.

It is the response time of the magnetic trip that differentiates each characteristic and for which an identifying letter is assigned. The IEC 898 standard only specifically covers the B, C, and D characteristics. The rest can vary from brand to brand, but essentially follow a uniform convention.

The following magnetic response times apply to each of the characteristic letters referenced in Eaton series FAZ part numbers:

- B: Instantaneous response of 3–5x I_n (I_n = fixed current rating of each unit)—ideally suited for resistive loads, such as conductors or heaters
- C: Instantaneous response of 5–10x I_n —ideally suited for inductive loads, such as motors and solenoids
- D: Instantaneous response of 10–20x I_n —ideally suited for highly inductive loads, such as lighting and higher efficiency motors
- K: Instantaneous response of 8–12x I_n —ideally suited for highly inductive loads, similar to D but with a narrower range
- S: Instantaneous response of 13–17x I_n —ideally suited for highly inductive loads, especially in control circuits with coils and light filaments
- Z: Instantaneous response of 2–3x I_n —very low instantaneous setting to provide tighter protection for loads that are more sensitive to the effects of overcurrents

Typical “inverse time” tripping characteristic of a miniature circuit breaker

- “Inverse time” refers to the device's tripping characteristic; as the curve shows, the higher the current, the lower the tripping time
- The trip response on the thermal portion is uniform throughout the line
- The instantaneous response differs, depending on the characteristic selected. (i.e., B, C, or D)
- Tripping is very quick (less than a half-cycle) in the upper range of overcurrents (bottom right) due to the current-limiting design of the Eaton series miniature circuit breakers

Miniature circuit breaker application

FAZ circuit breakers

PRODUCT OVERVIEW

Typical FAZ miniature circuit breaker characteristic

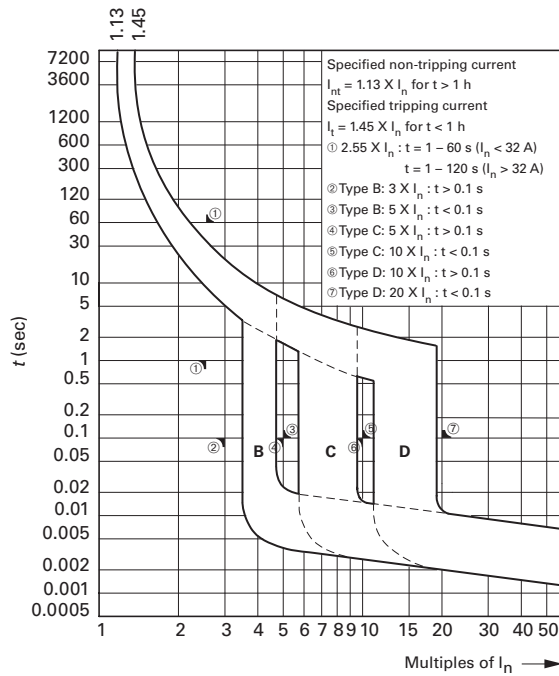

FAZ-NA(RT) miniature circuit breakers

As previously mentioned, we have expanded our FAZ line of miniature circuit breakers to include a version that is listed and certified as a molded-case circuit breaker (UL 489 and CSA No. 5).

This line is rated up to 40A and comes in single-, two-, and three-pole versions with instantaneous trip characteristics B, C and D. Of course, the line is also in conformity with the IEC standard for molded-case circuit breakers, IEC 60947-2, and can therefore be universally applied.

The NEC defines a circuit breaker as follows:

A device designed to open and close a circuit by non-automatic means and to open the circuit automatically on a predetermined overcurrent *without damage to itself when properly applied within its rating.*

Note the text in italics. In the eyes of the code, that definition sets circuit breakers apart from any other protective device and establishes their role as primary overcurrent protective switches in all types of electrical circuits. UL listing (and CSA Certification) requires additionally that regular testing on circuit breakers be conducted by UL and CSA at the manufacturer's plant to monitor construction and verify their performance.

The Eaton series new miniature molded-case circuit breaker line includes two types: the FAZ-NA with traditional box terminals for multiple wires, and the FAZ-RT which accommodates ring-tongue terminals.

The advantages of a current-limiting device

As already mentioned, all Eaton series FAZ devices are current-limiting by design. In the case of the UL 489 devices, they are also classified by UL/CSA in that manner and are marked on the label.

A circuit breaker that is marked as a current-limiting device is one that does not use a fusible element and, when operating within its current-limiting range, limits the let-through energy (I^2t) to less than the energy of a half-cycle wave of the available symmetrical current.

The label on FAZ-NA(RT) devices lists the actual let-through energy ($I^2t = 60 \text{ kA}^2 \text{ s}$) and peak let-through current (6.2 kA) at the maximum interrupting rating of 10 kA.

Current-limiting circuit breakers substantially reduce the amount of damage sustained by downstream components in the event of a high short-circuit fault by clearing the fault in the shortest amount of time possible due to the quick separation of its contacts and ensuing extinction of the arc current.

HACR and SWD

FAZ-NA(RT) circuit breakers are also marked "HACR" for use in heating, air conditioning, and refrigeration applications. In addition, the abbreviation "SWD" on the label indicates that the devices are suitable for switching fluorescent lighting loads on a regular basis.

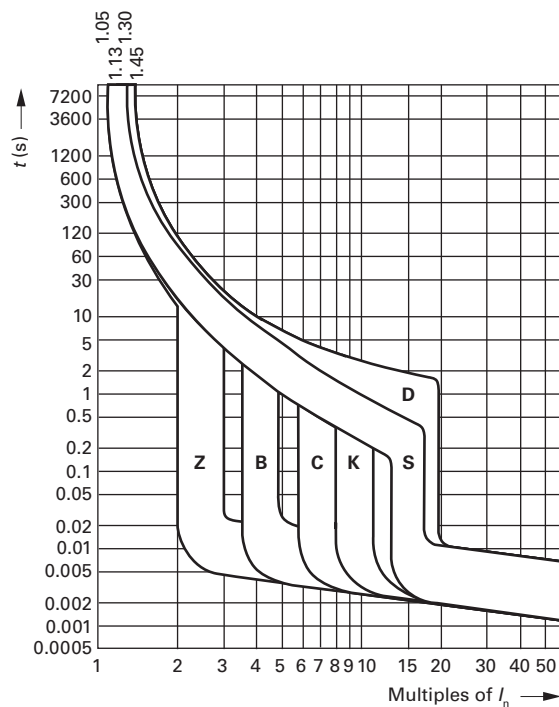

Miniature circuit breaker application

FAZ circuit breakers

TECHNICAL DATA

Short-circuit markings on FAZ devices

Below is a tabulated summary of short-circuit rating values that apply to the FAZ line of supplementary protectors and molded-case circuit breakers.

It is important to keep in mind that short-circuit markings on FAZ supplementary protectors (UL 1077) and FAZ-NA(RT) molded-case circuit breakers (UL 489) must not be interpreted in the same manner.

Supplementary protectors have short-circuit markings in association with upstream primary overcurrent protective devices. Conversely, molded-case circuit breakers are primary overcurrent protective devices, and their ratings thus refer to their short-circuit interrupting capability.

Short-Circuit Rating Values for FAZ Supplementary Protectors and Branch Circuit Breakers

Description	Trip Characteristic	Maximum Amperes	Maximum Volts	Short-Circuit Rating
FAZ Supplementary Protectors (UL 1077)				
Single-pole, single-pole + neutral	B and C	0.5–35A	277 Vac	10 kA
		40–63A	277 Vac	5 kA
	D, K, S, and Z	0.5–63A	48 Vdc	10 kA
		0.5–40A	277 Vac	5 kA
			48 Vdc	10 kA
Two-, three-, four-pole	B and C	0.5–35A	480Y/277 Vac ①	10 kA
		40–63A	480Y/277 Vac ①	5 kA
Two poles in series		6–25A	96 Vdc	10 kA
Two-, three-, four-pole	D, K, S, and Z	0.5–40A	480Y/277 Vac ①	5 kA
			96 Vdc	10 kA
FAZ-NA(RT) Branch Circuit Breakers (UL 489)				
Single-pole	B, C and D	0.5–32A	277 Vac	10 kA
		35–40A	240 Vac	10 kA
Single-pole—(NA) only	B, C and D	0.5–40A	48 Vdc	10 kA
Two-, three-pole	B, C and D	0.5–32A	480Y/277 Vac ①	10 kA
		35–40A	240 Vac	10 kA
Two-pole—(NA) only	C and D	0.5–40A	96 Vdc	10 kA
FAZ-NA(RT) Branch Circuit Breakers (UL 489)				
Single-pole	B and C	15–25A	277 Vac	14 kA
Two-, three-pole	B and C	15–25A	480Y/277 Vac ①	14 kA
Single-pole	D	13–20A	277 Vac	14 kA
Two-, three-pole	D	13–20A	480Y/277 Vac ①	14 kA
FAZ-(NA)-DC Branch Circuit Breakers (UL 489)				
Single-pole	C	2–40A	125 Vdc	10 kA
Two poles in series	C	2–40A	250 Vdc	10 kA

① A circuit breaker with a 480Y/277 Vac rating can be applied in a solidly grounded circuit where the nominal voltage of any conductor to ground does not exceed the lower value of the circuit breaker's rating (e.g., 277 Vac) and the nominal voltage between any two conductors does not exceed its higher value (480 Vac). These ratings typically can be found on protective devices such as molded-case circuit breakers and self-protected "Type E" combination motor controllers.



Eaton Corporation
Electrical Sector
1111 Superior Avenue
Cleveland, OH 44114 USA
Eaton.com

© 2013 Eaton Corporation
All Rights Reserved
Printed in USA
Publication No. PG01101009E / Z13096
January 2013

Eaton is a registered trademark
of Eaton Corporation.

All other trademarks are property
of their respective owners.