

LMV951 1V, 2.7 MHz, Rail-to-Rail Input and Output Amplifier with Shutdown Option

Check for Samples: [LMV951](#)

FEATURES

- (Typical 1.0V Supply, unless Otherwise Noted)
- Ensured 1V Single Supply Operation
- Wide Bandwidth
- No V_{OS} Glitch over the Input CMVR
- No Input I_{BIAS} Current Reversal over V_{CM} Range
- Buffered Output Stage
- High Output Drive Capability
 - Sink Current 35 mA
 - Source Current 45 mA
- Rail-to-Rail Buffered Output
 - At 600 Ω Load 32 mV from Either Rail
 - At 2 k Ω Load 12 mV from Either Rail
- Temperature Range -40°C to 125°C

APPLICATIONS

- Battery Operated Systems
- Battery Monitoring
- Supply Current Monitoring

VIRTUAL GROUND CIRCUIT

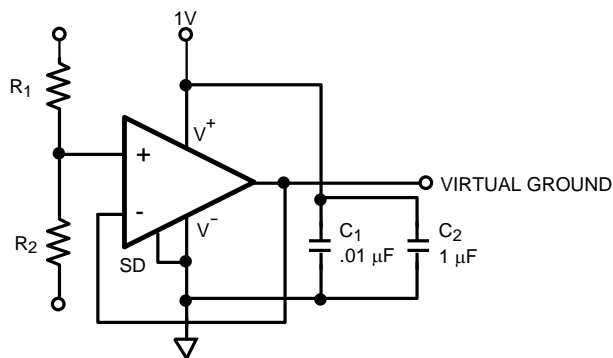

DESCRIPTION

The LMV951 amplifier is capable of operating at supply voltages from 0.9V to 3V with specified specs at 1V and 1.8V single supply.

The input common mode range extends to both power supply rails without the offset glitch and input bias current phase reversal inherent to most rail to rail input amplifiers.

Contrary to a conventional rail to rail output amplifier the LMV951 has a buffered output stage providing an open loop gain which is relatively unaffected by resistive output loading. At 1V supply voltage, the LMV951 is able to sink in excess of 35 mA and offers a gain bandwidth product of 2.7 MHz.

In shutdown mode the LMV951 consumes less than 50 nA of supply current.

Open Loop Gain and Phase

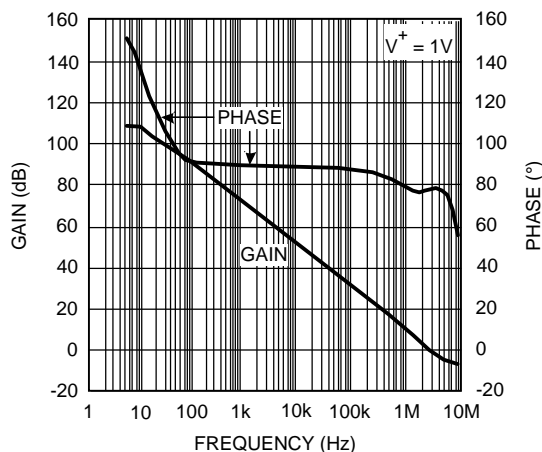

Please be aware that an important notice concerning availability, standard warranty, and use in critical applications of Texas Instruments semiconductor products and disclaimers thereto appears at the end of this data sheet.

All trademarks are the property of their respective owners.



These devices have limited built-in ESD protection. The leads should be shorted together or the device placed in conductive foam during storage or handling to prevent electrostatic damage to the MOS gates.

ABSOLUTE MAXIMUM RATINGS ⁽¹⁾⁽²⁾

ESD Tolerance ⁽³⁾	Human Body Model	2000V
	Machine Model	200V
Supply Voltage ($V^+ - V^-$)		3.1V
V_{IN} Differential		$\pm 0.3V$
Voltage at Input/Output Pin		$V^+ +0.3V, V^- -0.3V$
Current at Input Pin		$\pm 10\text{ mA}$
Junction Temperature ⁽⁴⁾		+150°C
Mounting Temperature	Infrared or Convection (20 sec)	235°C

- (1) Absolute Maximum Ratings indicate limits beyond which damage to the device may occur. Operating Ratings indicate conditions for which the device is intended to be functional, but specific performance is not ensured. For ensured specifications and the test conditions, see the Electrical Characteristics.
- (2) If Military/Aerospace specified devices are required, please contact the Texas Instruments Sales Office/ Distributors for availability and specifications.
- (3) Human Body Model, applicable std. MIL-STD-883, Method 3015.7. Machine Model, applicable std. JESD22-A115-A (ESD MM std. of JEDEC) Field-Induced Charge-Device Model, applicable std. JESD22-C101-C (ESD FICDM std. of JEDEC).
- (4) The maximum power dissipation is a function of $T_{J(MAX)}$, θ_{JA} . The maximum allowable power dissipation at any ambient temperature is $P_D = (T_{J(MAX)} - T_A)/\theta_{JA}$. All numbers apply for packages soldered directly onto a PC Board.

OPERATING RATINGS ⁽¹⁾

Temperature Range ⁽²⁾	-40°C to +125°C
Supply Voltage	0.9V to 3V
Thermal Resistance (θ_{JA}) ⁽²⁾	170°C/W

- (1) Absolute Maximum Ratings indicate limits beyond which damage to the device may occur. Operating Ratings indicate conditions for which the device is intended to be functional, but specific performance is not ensured. For ensured specifications and the test conditions, see the Electrical Characteristics.
- (2) The maximum power dissipation is a function of $T_{J(MAX)}$, θ_{JA} . The maximum allowable power dissipation at any ambient temperature is $P_D = (T_{J(MAX)} - T_A)/\theta_{JA}$. All numbers apply for packages soldered directly onto a PC Board.

1V ELECTRICAL CHARACTERISTICS ⁽¹⁾

Unless otherwise specified, all limits specified for at $T_A = 25^\circ\text{C}$, $V^+ = 1$, $V^- = 0\text{V}$, $V_{\text{CM}} = 0.5\text{V}$, Shutdown = 0V , and $R_L = 1\text{M}\Omega$. **Boldface** limits apply at the temperature extremes.

Symbol	Parameter	Conditions	Min ⁽²⁾	Typ ⁽³⁾	Max ⁽²⁾	Units
V_{OS}	Input Offset Voltage			1.5	2.8 3.0	mV
TC V_{OS}	Input Offset Average Drift			0.15		$\mu\text{V}/^\circ\text{C}$
I_{B}	Input Bias Current			32	80 85	nA
I_{OS}	Input Offset Current			0.2		nA
CMRR	Common Mode Rejection Ratio	$0\text{V} \leq V_{\text{CM}} \leq 1\text{V}$	67 55	77		dB
		$0.1\text{V} \leq V_{\text{CM}} \leq 1\text{V}$	76 73	85		
PSRR	Power Supply Rejection Ratio	$1\text{V} \leq V^+ \leq 1.8\text{V}$, $V_{\text{CM}} = 0.5\text{V}$	70 67	92		dB
		$1\text{V} \leq V^+ \leq 3\text{V}$, $V_{\text{CM}} = 0.5\text{V}$	68 65	85		
V_{CM}	Input Common-Mode Voltage Range	CMRR $\geq 67\text{ dB}$	0		1.2	V
		CMRR $\geq 55\text{ dB}$	0		1.2	
A_{V}	Large Signal Voltage Gain	$V_{\text{OUT}} = 0.1\text{V to } 0.9\text{V}$ $R_L = 600\Omega \text{ to } 0.5\text{V}$	90 85	106		dB
		$V_{\text{OUT}} = 0.1\text{V to } 0.9\text{V}$ $R_L = 2\text{ k}\Omega \text{ to } 0.5\text{V}$	90 86	112		
V_{OUT}	Output Voltage Swing High	$R_L = 600\Omega \text{ to } 0.5\text{V}$	50 62	25		mV from rail
		$R_L = 2\text{ k}\Omega \text{ to } 0.5\text{V}$	25 36	12		
	Output Voltage Swing Low	$R_L = 600\Omega \text{ to } 0.5\text{V}$	70 85	32		
		$R_L = 2\text{ k}\Omega \text{ to } 0.5\text{V}$	35 40	10		
I_{OUT}	Output Short Circuit Current ⁽⁴⁾	Sourcing $V_{\text{O}} = 0\text{V}$, $V_{\text{IN(DIFF)}} = \pm 0.2\text{V}$	20 15	45		mA
		Sinking $V_{\text{O}} = 1\text{V}$, $V_{\text{IN(DIFF)}} = \pm 0.2\text{V}$	20 13	35		
I_{S}	Supply Current	Active Mode $V_{\text{SD}} < 0.4\text{V}$		370	480 520	μA
		Shutdown Mode $V_{\text{SD}} > 0.6\text{V}$		0.01	1.0 3.0	
SR	Slew Rate	See ⁽⁵⁾		1.4		V/ μs
GBWP	Gain Bandwidth Product			2.7		MHz
e_{n}	Input - Referred Voltage Noise	$f = 1\text{ kHz}$		25		$\text{nV}/\sqrt{\text{Hz}}$
i_{n}	Input-Referred Current Noise	$f = 1\text{ kHz}$		0.2		$\text{pA}/\sqrt{\text{Hz}}$
THD	Total Harmonic Distortion	$f = 1\text{ kHz}$, $A_{\text{V}} = 1$, $R_L = 1\text{ k}\Omega$		0.02		%
I_{SD}	Shutdown Pin Current	Active Mode, $V_{\text{SD}} = 0\text{V}$.001	1	μA
		Shutdown Mode, $V_{\text{SD}} = 1\text{V}$.001	1	
V_{SD}	Shutdown Pin Voltage Range	Active Mode	0		0.4	V
		Shutdown Mode	0.65		1	

- (1) Electrical table values apply only for factory testing conditions at the temperature indicated. Factory testing conditions is very limited self-heating of the device.
- (2) All limits are specified by testing or statistical analysis.
- (3) Typical values represent the most likely parametric norm as determined at the time of characterization. Actual typical values may vary over time and will also depend on the application and configuration. The typical values are not tested and are not ensured on shipped production material.
- (4) The short circuit test is a momentary test, the short circuit duration is 1.5 ms
- (5) Number specified is the average of the positive and negative slew rates.

1.8V ELECTRICAL CHARACTERISTICS ⁽¹⁾

Unless otherwise specified, all limits specified for at $T_A = 25^\circ\text{C}$, $V^+ = 1.8\text{V}$, $V^- = 0\text{V}$, $V_{\text{CM}} = 0.9\text{V}$, Shutdown = 0V , and $R_L = 1\text{M}\Omega$. **Boldface** limits apply at the temperature extremes.

Symbol	Parameter	Conditions	Min ⁽²⁾	Typ ⁽³⁾	Max ⁽²⁾	Units
V_{OS}	Input Offset Voltage			1.5	2.8 3.0	mV
TC V_{OS}	Input Offset Average Drift			0.15		$\mu\text{V}/^\circ\text{C}$
I_{B}	Input Bias Current			36	80 85	nA
I_{OS}	Input Offset Current			0.2		nA
CMRR	Common Mode Rejection Ratio	$0\text{V} \leq V_{\text{CM}} \leq 1.8\text{V}$	82 80	93		dB
PSRR	Power Supply Rejection Ratio	$1\text{V} \leq V^+ \leq 1.8\text{V}$, $V_{\text{CM}} = 0.5\text{V}$	70 67	92		dB
		$1\text{V} \leq V^+ \leq 3\text{V}$, $V_{\text{CM}} = 0.5\text{V}$	68 65	85		
V_{CM}	Input Common-Mode Voltage Range	CMRR $\geq 82\text{ dB}$	-0.2		2	V
		CMRR $\geq 80\text{ dB}$	-0.2		2	
A_{V}	Large Signal Voltage Gain	$V_{\text{OUT}} = 0.2\text{ to }1.6\text{V}$ $R_L = 600\Omega\text{ to }0.9\text{V}$	86 83	110		dB
		$V_{\text{OUT}} = 0.2\text{ to }1.6\text{V}$ $R_L = 2\text{ k}\Omega\text{ to }0.9\text{V}$	86 83	116		
V_{OUT}	Output Voltage Swing High	$R_L = 600\Omega\text{ to }0.9\text{V}$	50 60	33		mV from rail
		$R_L = 2\text{ k}\Omega\text{ to }0.9\text{V}$	25 34	13		
	Output Voltage Swing Low	$R_L = 600\Omega\text{ to }0.9\text{V}$	80 105	54		
		$R_L = 2\text{ k}\Omega\text{ to }0.9\text{V}$	35 44	17		
I_{OUT}	Output Short Circuit Current ⁽⁴⁾	Sourcing $V_{\text{O}} = 0\text{V}$, $V_{\text{IN(DIFF)}} = \pm 0.2\text{V}$	50 35	85		mA
		Sinking $V_{\text{O}} = 1.8\text{V}$, $V_{\text{IN(DIFF)}} = \pm 0.2\text{V}$	45 25	80		
I_{S}	Supply Current	Active Mode $V_{\text{SD}} < 0.5\text{V}$		570	780 880	μA
		Shutdown Mode $V_{\text{SD}} > 1.3\text{V}$		0.3	2.2 10	
SR	Slew Rate	See ⁽⁵⁾		1.4		$\text{V}/\mu\text{s}$
GBWP	Gain Bandwidth Product			2.8		MHz
e_{n}	Input - Referred Voltage Noise	$f = 1\text{ kHz}$		25		$\text{nV}/\sqrt{\text{Hz}}$
i_{n}	Input-Referred Current Noise	$f = 1\text{ kHz}$		0.2		$\text{pA}/\sqrt{\text{Hz}}$
THD	Total Harmonic Distortion	$f = 1\text{ kHz}$, $A_{\text{V}} = 1$, $R_L = 1\text{ k}\Omega$		0.02		%
I_{SD}	Shutdown Pin Current	Active Mode, $V_{\text{SD}} = 0\text{V}$.001	1	μA
		Shutdown Mode, $V_{\text{SD}} = 1.8\text{V}$.001	1	
V_{SD}	Shutdown Pin Voltage Range	Active Mode	0		0.5	V
		Shutdown Mode	1.45		1.8	

- (1) Electrical table values apply only for factory testing conditions at the temperature indicated. Factory testing conditions is very limited self-heating of the device.
- (2) All limits are specified by testing or statistical analysis.
- (3) Typical values represent the most likely parametric norm as determined at the time of characterization. Actual typical values may vary over time and will also depend on the application and configuration. The typical values are not tested and are not ensured on shipped production material.
- (4) The short circuit test is a momentary test, the short circuit duration is 1.5 ms
- (5) Number specified is the average of the positive and negative slew rates.

CONNECTION DIAGRAM

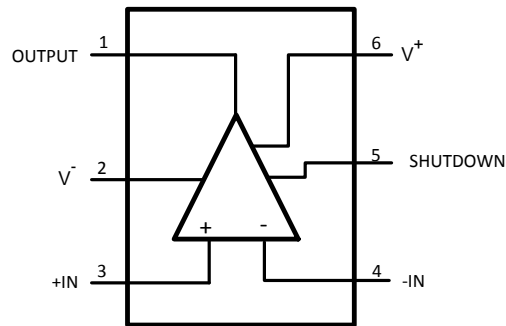
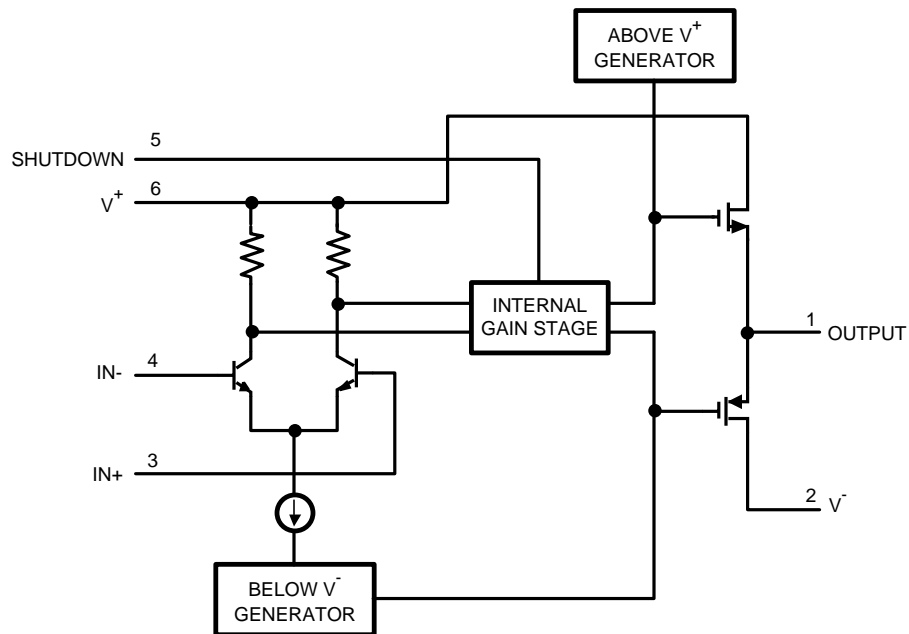

Figure 1. 6-Pin SOT23- Top View
See Package Number DDC

SIMPLIFIED SCHEMATIC



TYPICAL PERFORMANCE CHARACTERISTICS

Unless otherwise specified, all limits are specified for $T_A = 25^\circ\text{C}$, $V^+ = 1\text{V}$, $V^- = 0\text{V}$, $V_{CM} = V^+/2 = V_O$. **Boldface** limits apply at the temperature extremes.

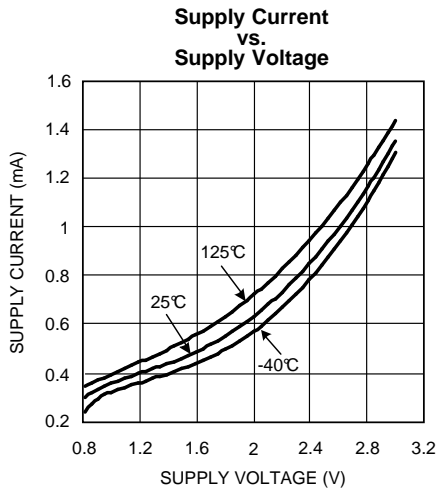

Figure 2.

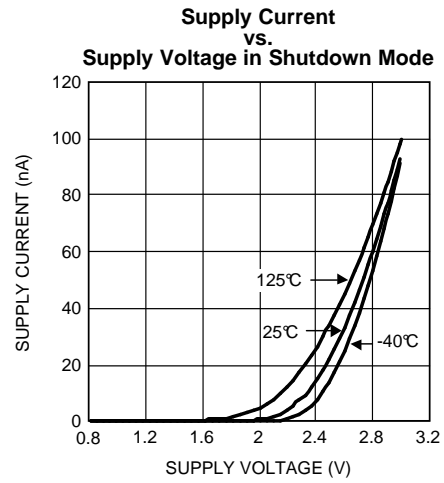

Figure 3.

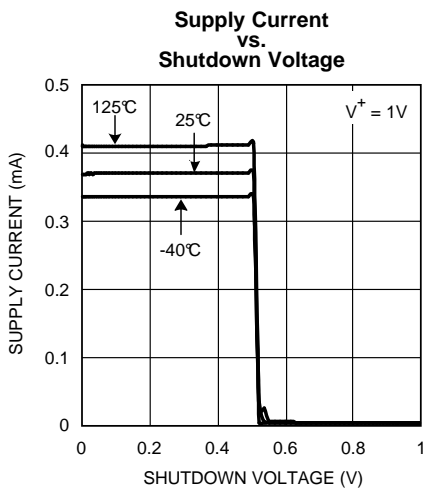

Figure 4.

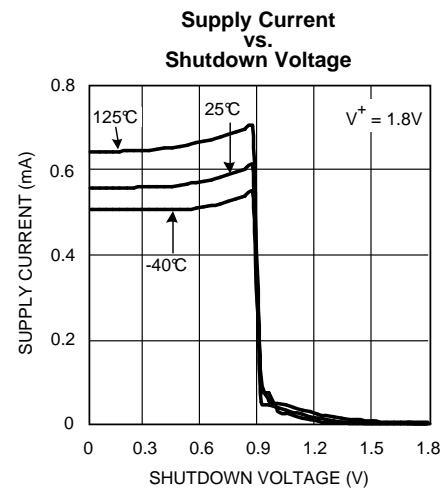

Figure 5.

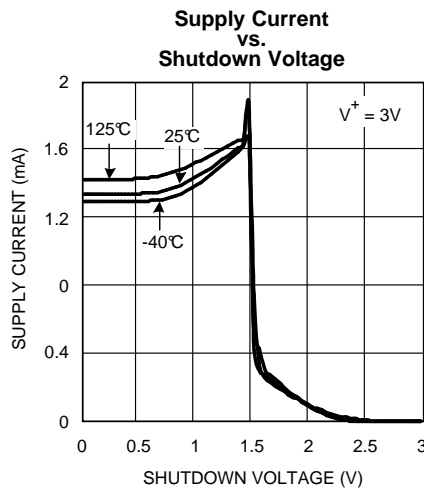

Figure 6.

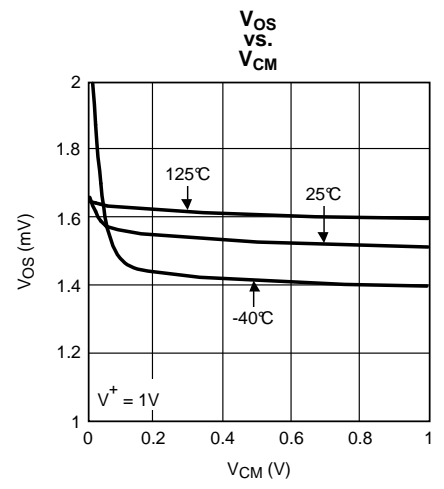

Figure 7.

TYPICAL PERFORMANCE CHARACTERISTICS (continued)

Unless otherwise specified, all limits are specified for $T_A = 25^\circ\text{C}$, $V^+ = 1\text{V}$, $V^- = 0\text{V}$, $V_{\text{CM}} = V^+/2 = V_O$. **Boldface** limits apply at the temperature extremes.

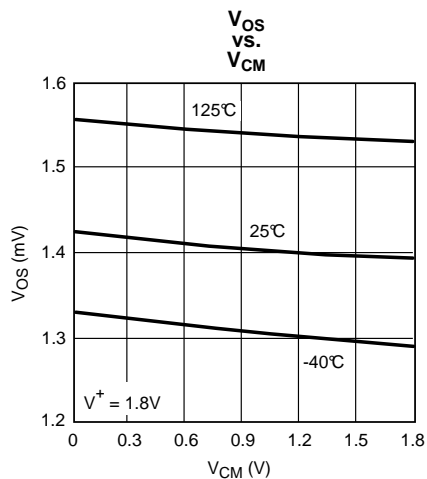

Figure 8.

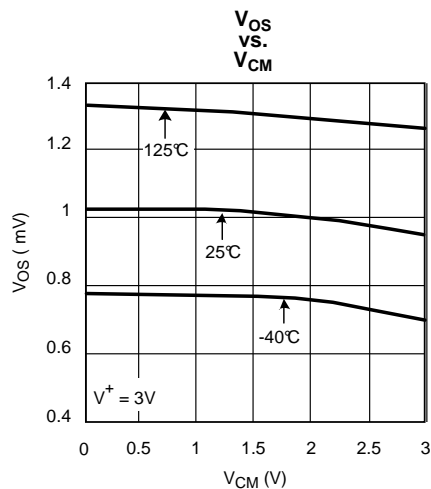

Figure 9.

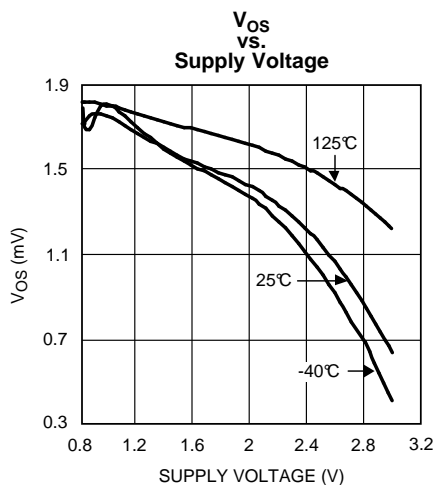

Figure 10.

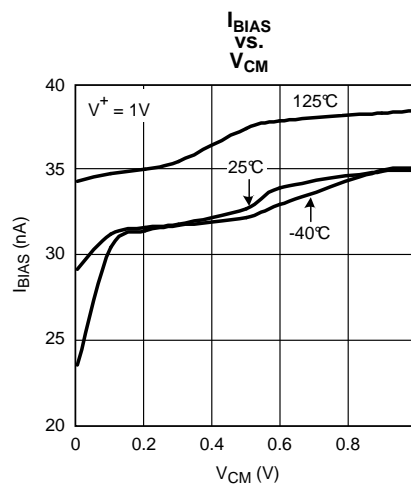

Figure 11.

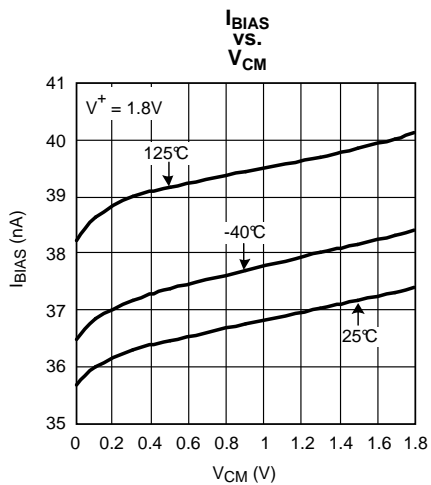

Figure 12.

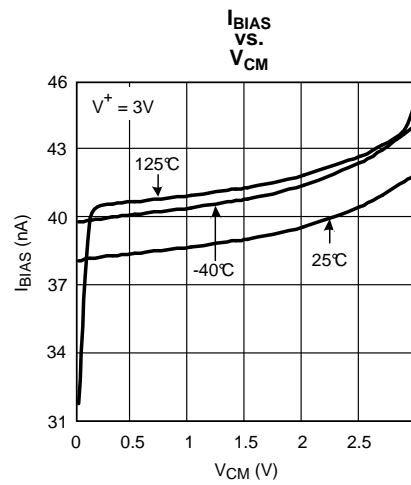

Figure 13.

TYPICAL PERFORMANCE CHARACTERISTICS (continued)

Unless otherwise specified, all limits are specified for $T_A = 25^\circ\text{C}$, $V^+ = 1\text{V}$, $V^- = 0\text{V}$, $V_{CM} = V^+/2 = V_O$. **Boldface** limits apply at the temperature extremes.

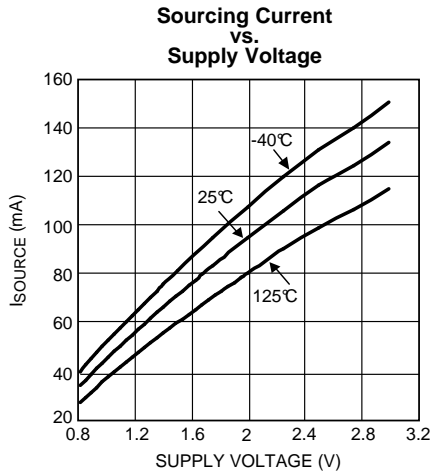

Figure 14.

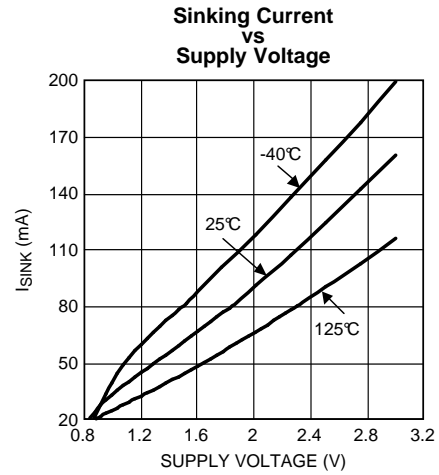

Figure 15.

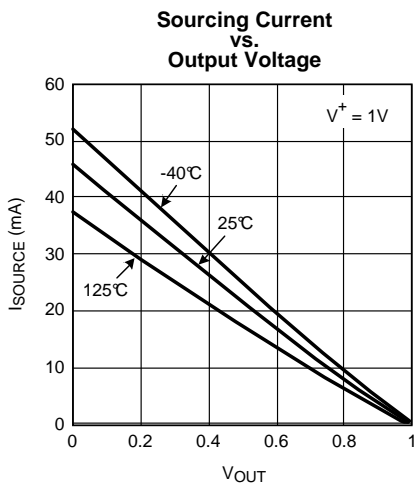

Figure 16.

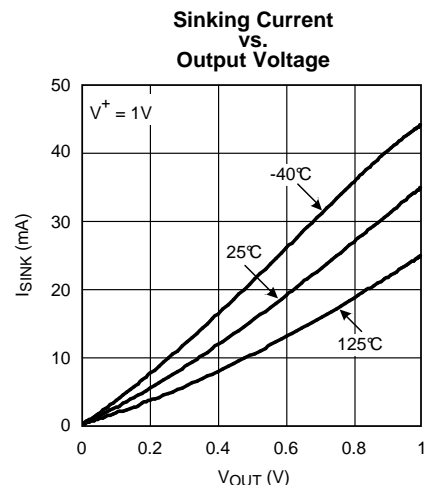

Figure 17.

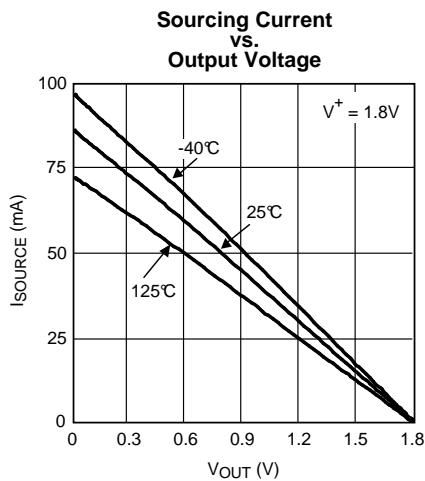

Figure 18.

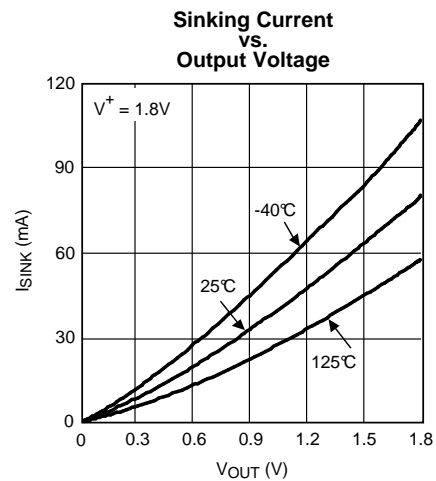

Figure 19.

TYPICAL PERFORMANCE CHARACTERISTICS (continued)

Unless otherwise specified, all limits are specified for $T_A = 25^\circ\text{C}$, $V^+ = 1\text{V}$, $V^- = 0\text{V}$, $V_{\text{CM}} = V^+/2 = V_O$. **Boldface** limits apply at the temperature extremes.

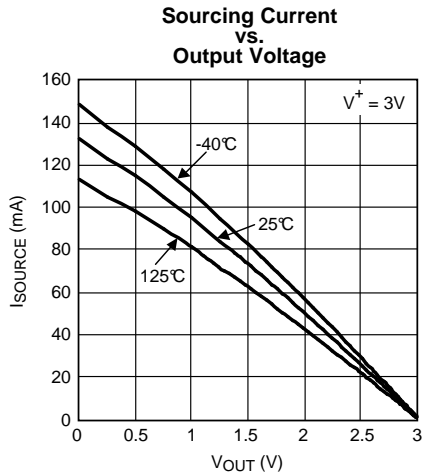

Figure 20.

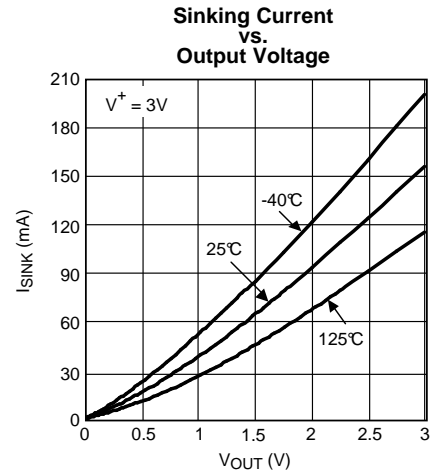

Figure 21.

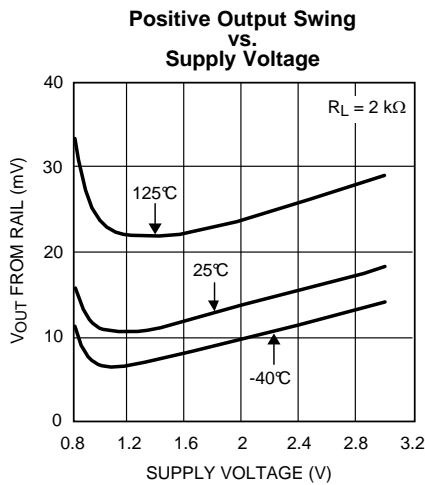

Figure 22.

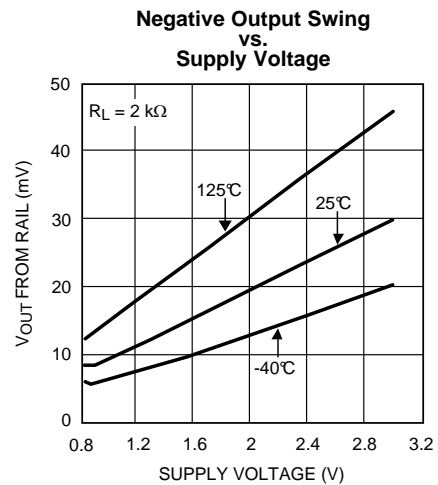

Figure 23.

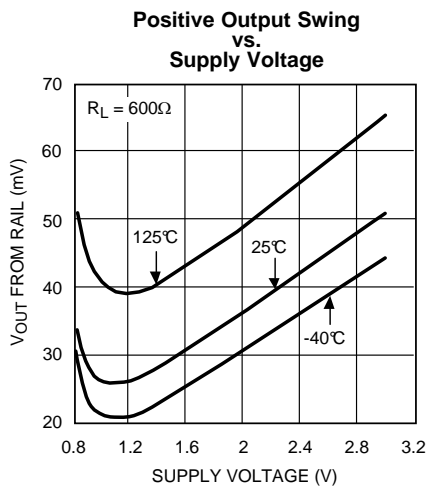

Figure 24.

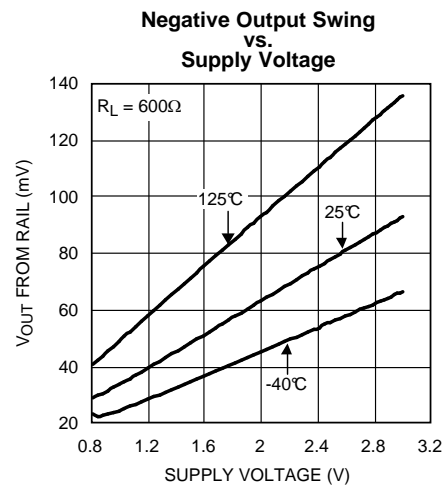

Figure 25.

TYPICAL PERFORMANCE CHARACTERISTICS (continued)

Unless otherwise specified, all limits are specified for $T_A = 25^\circ\text{C}$, $V^+ = 1\text{V}$, $V^- = 0\text{V}$, $V_{CM} = V^+/2 = V_O$. **Boldface** limits apply at the temperature extremes.

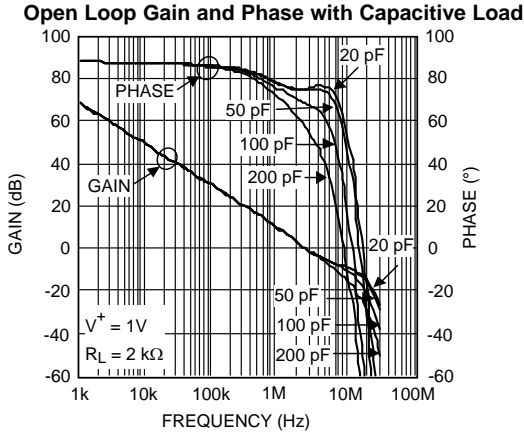

Figure 26.

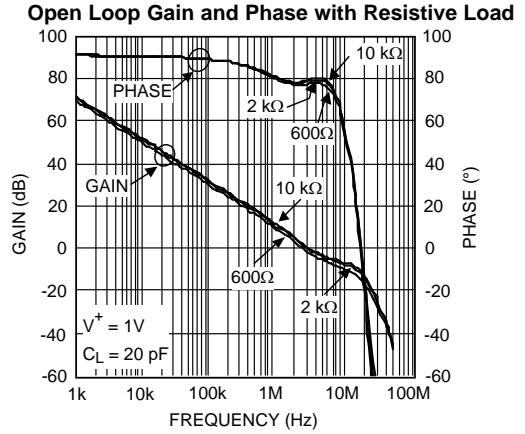

Figure 27.

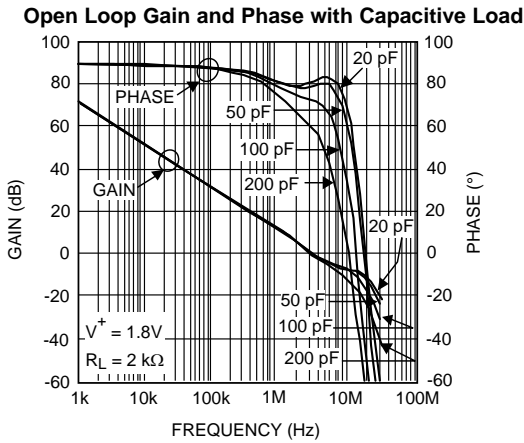

Figure 28.

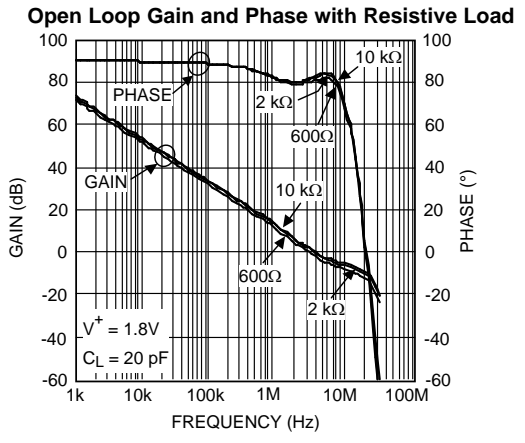

Figure 29.

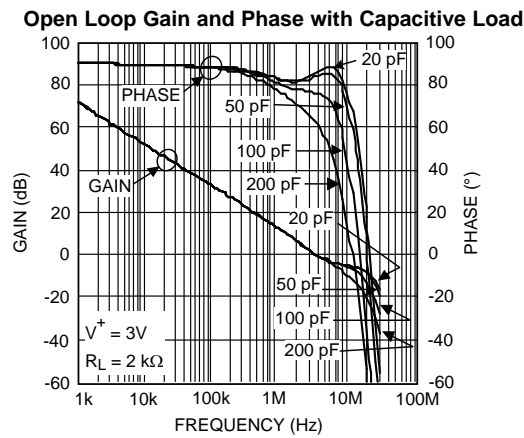

Figure 30.

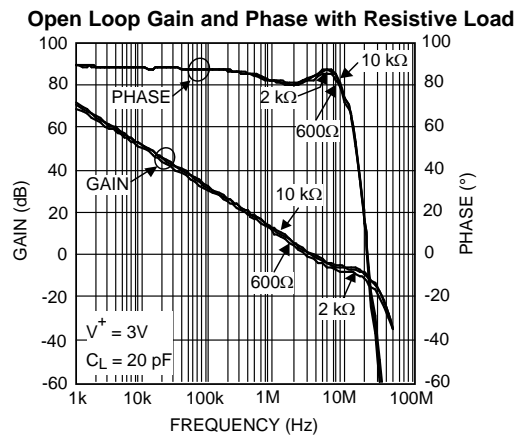

Figure 31.

TYPICAL PERFORMANCE CHARACTERISTICS (continued)

Unless otherwise specified, all limits are specified for $T_A = 25^\circ\text{C}$, $V^+ = 1\text{V}$, $V^- = 0\text{V}$, $V_{CM} = V^+/2 = V_O$. **Boldface** limits apply at the temperature extremes.

Small Signal Transient Response, $A_V = +1$

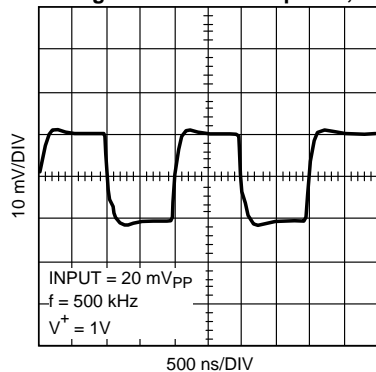

Figure 32.

Large Signal Transient Response, $A_V = +1$

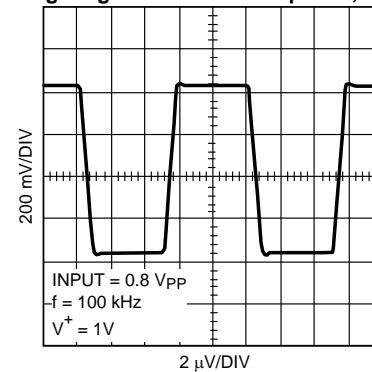

Figure 33.

Small Signal Transient Response, $A_V = +1$

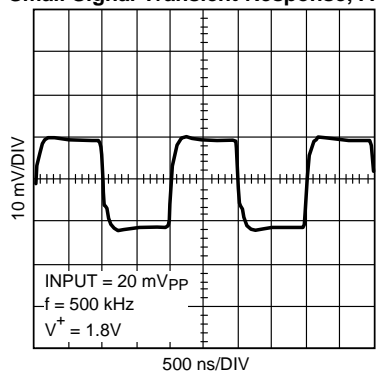

Figure 34.

Large Signal Transient Response, $A_V = +1$

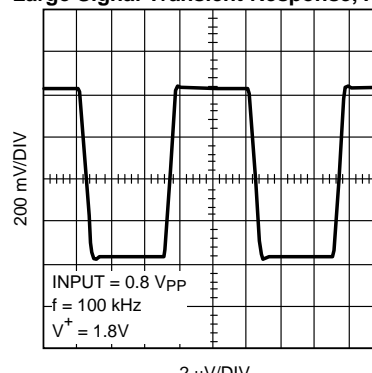

Figure 35.

Small Signal Transient Response, $A_V = +1$

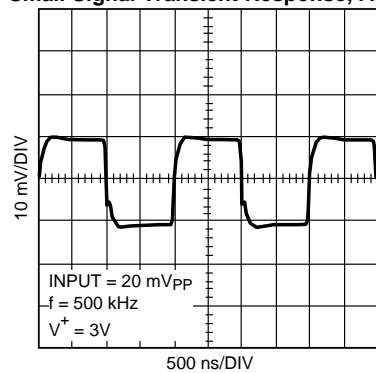

Figure 36.

Large Signal Transient Response, $A_V = +1$

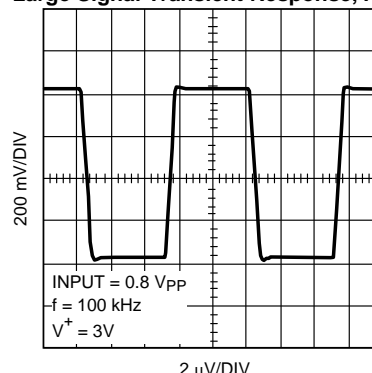

Figure 37.

TYPICAL PERFORMANCE CHARACTERISTICS (continued)

Unless otherwise specified, all limits are specified for $T_A = 25^\circ\text{C}$, $V^+ = 1\text{V}$, $V^- = 0\text{V}$, $V_{CM} = V^+/2 = V_O$. **Boldface** limits apply at the temperature extremes.

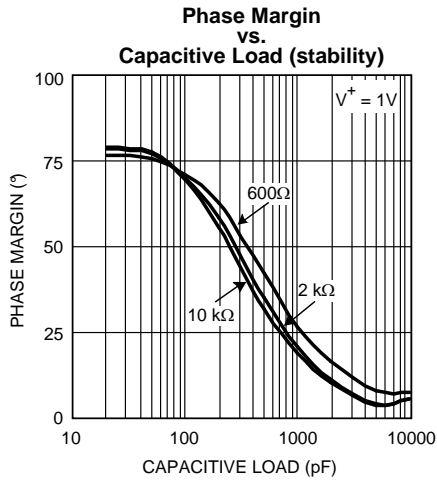

Figure 38.

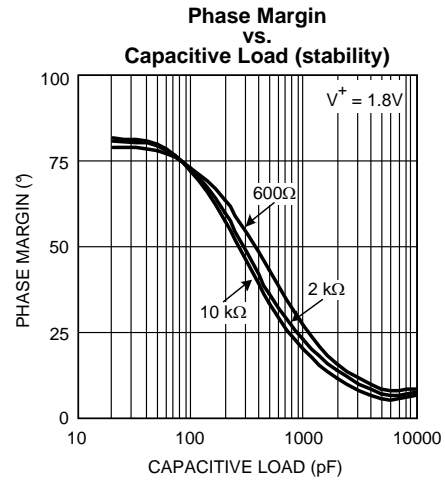

Figure 39.

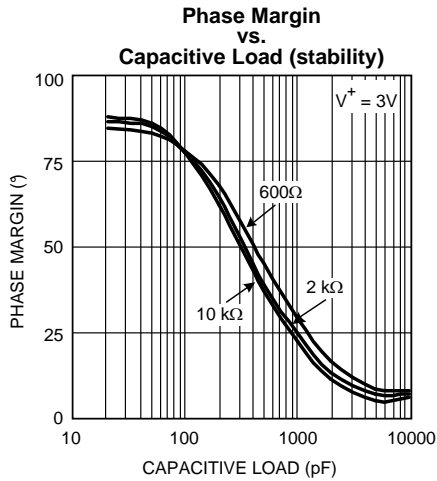

Figure 40.

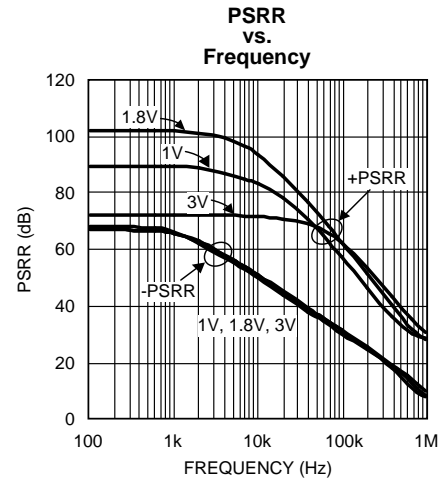

Figure 41.

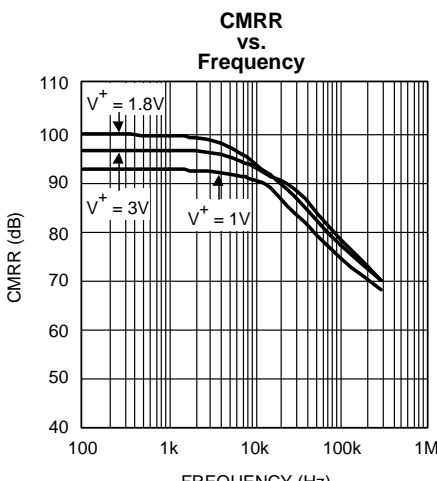

Figure 42.

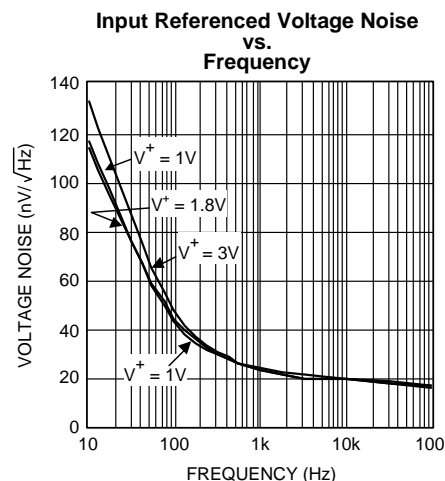

Figure 43.

TYPICAL PERFORMANCE CHARACTERISTICS (continued)

Unless otherwise specified, all limits are specified for $T_A = 25^\circ\text{C}$, $V^+ = 1\text{V}$, $V^- = 0\text{V}$, $V_{CM} = V^+/2 = V_O$. **Boldface** limits apply at the temperature extremes.

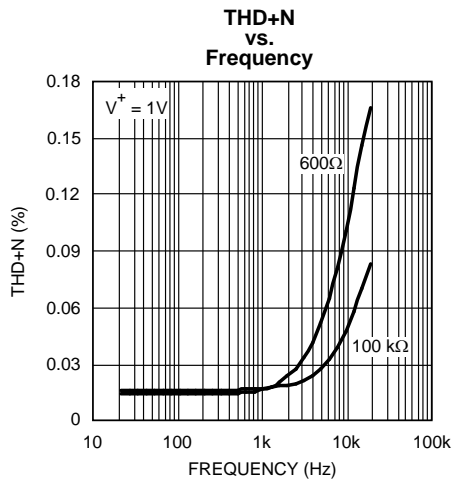

Figure 44.

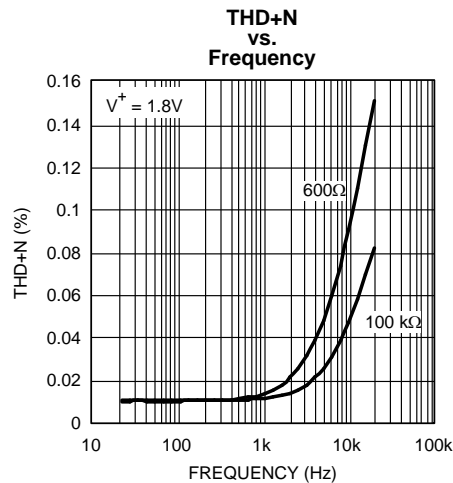

Figure 45.

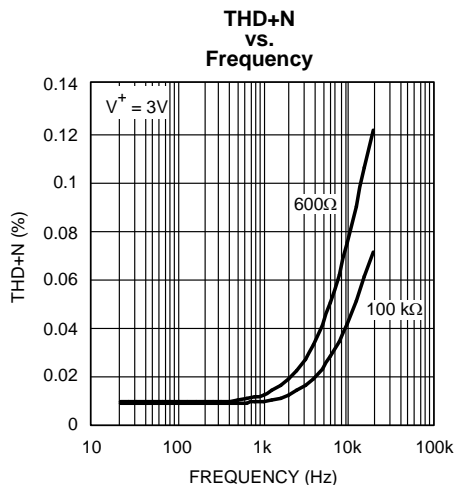

Figure 46.

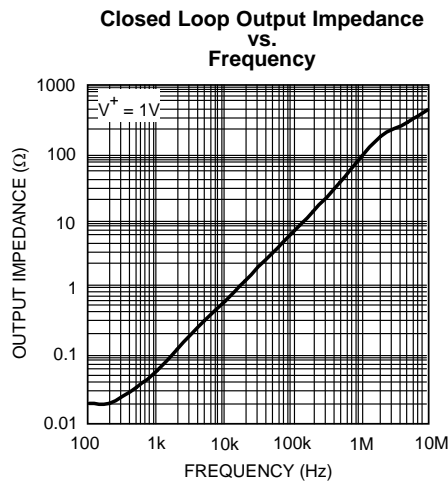

Figure 47.

APPLICATION INFORMATION

CIRCUIT DESCRIPTION AND ADVANTAGE OF THE LMV951

The LMV951 utilizes an internal voltage generator which allows for rail to rail input and output operation from 1 to 3V supplies. An internal switching frequency between 10 MHz and 15 MHz is used for generating the internal voltages.

The bipolar input stage provides rail to rail input operation with no input bias current phase reversal and a constant input offset voltage over the entire input common mode range.

The CMOS output stage provides a gain that is virtually independent of resistive loads and an output drive current in excess of 35 mA at 1V. A further benefit of the output stage is that the LMV951 is stable in positive unity gain at capacitive loads in excess of 1000 pF.

BATTERY OPERATED SYSTEMS

The maximum operating voltage is 3V and the operating characteristics are ensured down to 1V which makes the LMV951 an excellent choice for battery operated systems using one or two NiCd or NiMH cells. The LMV951 is also functional at 0.9V making it an appropriate choice for a single cell alkaline battery.

SHUTDOWN CAPABILITY

While in shutdown mode, the LMV951 typically consumes less than 50 nA of supply current making it ideal for power conscious applications. Full functionality is restored within 3 μ s of enable.

SMALL SIZE

The small footprint of the LMV951 package is ideal for high density board systems. By using the small 6-Pin SOT23 package, the amplifier can be placed closer to the signal source, reducing noise pickup and increasing signal integrity.

POWER SUPPLY BYPASSING

As in any high performance IC, proper power supply bypassing is necessary for optimizing the performance of the LMV951. The internal voltage generator needs proper bypassing for optimum operation. A surface mount ceramic .01 μ F capacitor must be located as close as possible to the V^+ and V^- pins (pins 2 and 6). This capacitor needs to have low ESR and a self resonant frequency above 15 MHz. A small tantalum or electrolytic capacitor with a value between 1 μ F and 10 μ F also needs to be located close to the LMV951.

DRIVING CAPACITIVE LOAD

The unity gain follower is the most sensitive op amp configuration to capacitive loading; the LMV951 can drive up to 10,000 pF in this configuration without oscillation. If the application requires a phase margin greater than those shown in the datasheet graphs, a snubber network is recommended. The snubber offers the advantage of reducing the output signal ringing while maintaining the output swing which ensures a wider dynamic range; this is especially important at lower supply voltages.

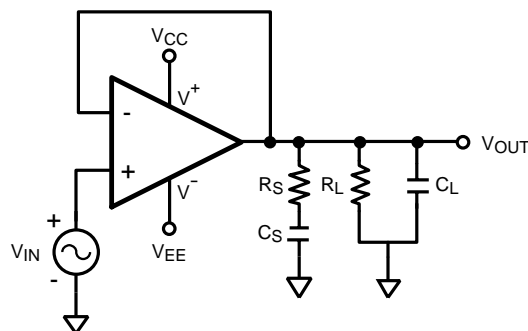

Figure 48. Snubber Network to Improve Phase Margin

The chart below gives recommended values for some common values of large capacitors. For these values $R_L = 2\text{ k}\Omega$;

C_L	R_S	C_S
500 pF	330 Ω	6800 pF
680 pF	270 Ω	8200 pF
1000 pF	220 Ω	.015 μF

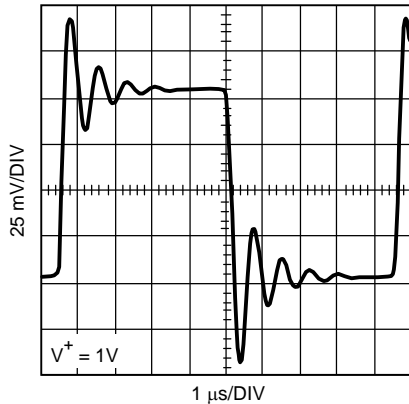

Figure 49. 1000 pF and no Snubber

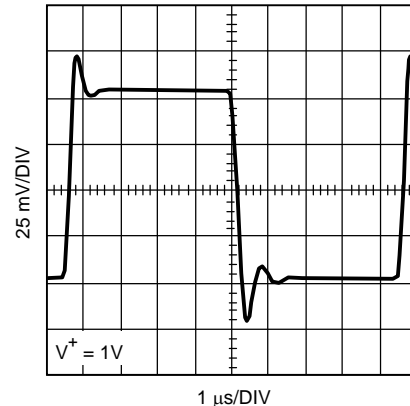

Figure 50. 1000 pF with Snubber

BRIDGE CONFIGURATION AMPLIFIER

Some applications may benefit from doubling the voltage across the load. With $V^+ = 1\text{V}$ a bridge configuration can provide a 2 V_{PP} output to the load with a resistance as low as 300Ω . The output stage of the LMV951 enables it to drive a load of 120Ω and still swing at least 70% of the supply rails.

The bridge configuration shown in [Figure 51](#) enables the amplifier to maintain a low dropout voltage thus maximizing its dynamic range. It has been configured in a gain of 1 and uses the fewest number of parts.

Resistor values have been selected to keep the current consumption to a minimum and voltage errors due to bias currents negligible. Using the selected resistor values makes this circuit quite practical in a battery operated design. R_1 , R_2 and R_5 , R_6 set up a virtual ground that is half of V^+ . Note that the accuracy of the resistor values will establish how well the two virtual grounds match. Any errors in the virtual grounds will show as current across R_L when there is no input signal.

AC coupling the input signal sets the DC bias point of this signal to the virtual ground of the circuit. Using the large resistor values with a $1\text{ }\mu\text{F}$ capacitor (C_1) sets the frequency rolloff of this circuit below 10 Hz.

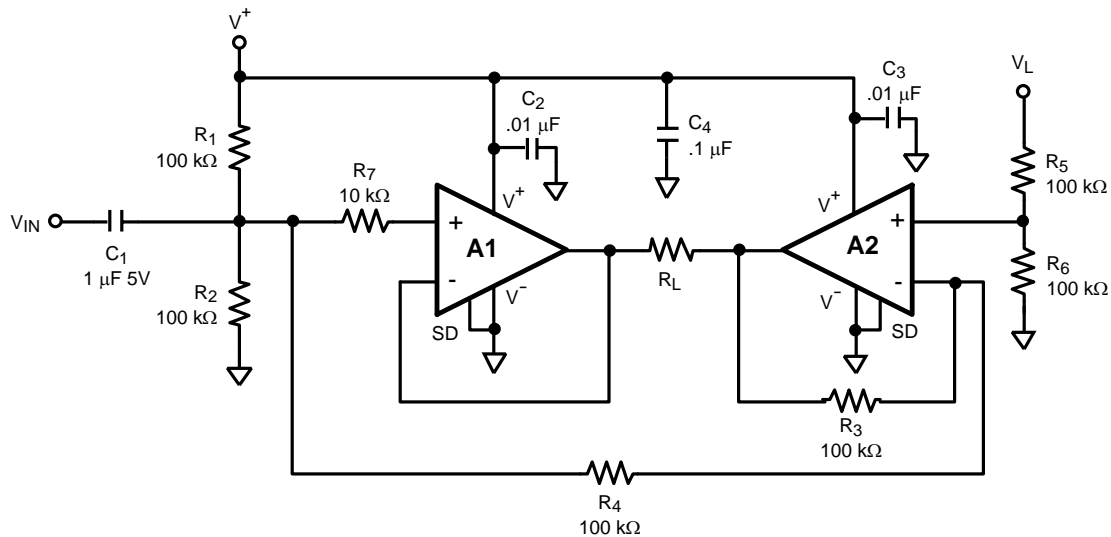

Figure 51. Bridge Amplifier

- C_2 and C_3 are $.01 \mu\text{F}$ ceramic capacitors that must be located as close as possible to pin 6, the V^+ pin. As covered in the power supply bypassing section these capacitors must have low ESR and a self resonant frequency above 15 MHz.
- C_4 is a $1 \mu\text{F}$ tantalum or electrolytic capacitor that should also be located close to the supply pin.
- To use the shutdown feature tie pin 5 of the two parts together and connect through a $470 \text{ k}\Omega$ resistor to V^+ . Add a switch between pin 5 and ground. Closing the switch keeps the parts in the active mode, opening the switch sets the parts in the shutdown mode without adding any additional current to V^+ .

VIRTUAL GROUND CIRCUIT

The front page of this data sheet shows the LMV951 being used in a system establishing a virtual ground. Having a buffered output stage gives this part the ability to handle load currents higher than 35 mA at 1V.

R_3 and R_4 are used to set the voltage of the virtual ground. To maintain low noise the values should be between $1 \text{ k}\Omega$ and $10 \text{ k}\Omega$. C_1 and C_2 provide the recommended bypassing for the LMV951. These caps must be placed as close as possible to pins 2 and 6.

TWO WIRE LINE TRANSMISSION

The robust output stage of the LMV951 makes it an excellent choice for driving long cables. The circuit shown below in [Figure 52](#) can drive a long cable using only two wires; power and ground.

When many sensors are located remotely from the control area the wiring becomes a significant expense. Using only two wires helps minimize the wiring expense in a large project such as an industrial plant. [Figure 53](#) shows a 25 kHz signal after passing through 1000 ft. of twisted pair cable. [Figure 54](#) shows a 200 kHz signal after passing through 50 ft. of twisted pair cable.

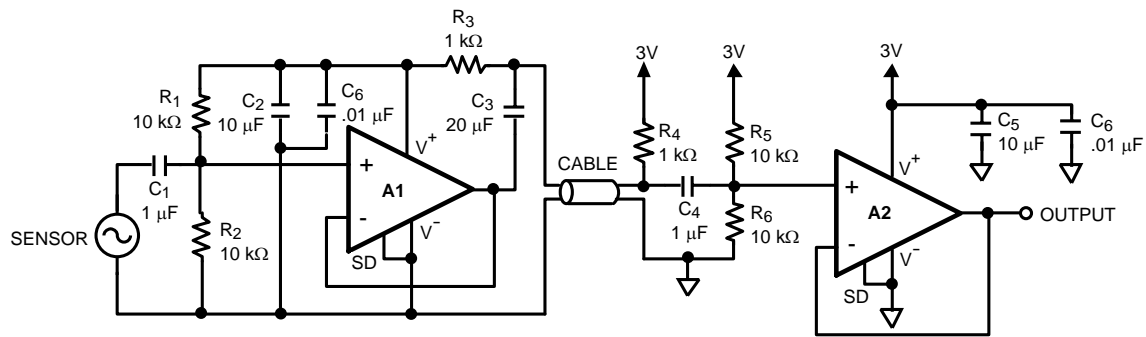

Figure 52. Two Wire Line Driver

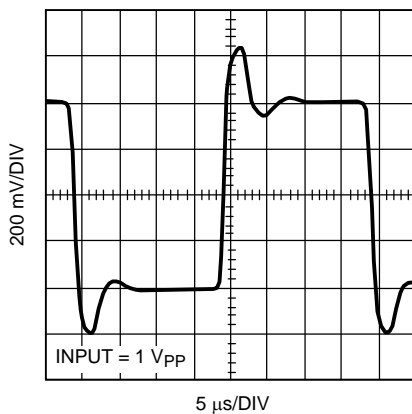

Figure 53. 25 kHz Through 1000 ft.

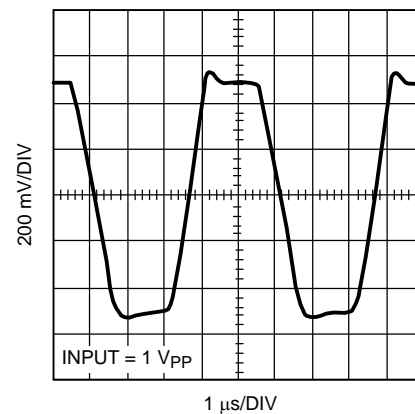

Figure 54. 200 kHz Through 50 ft.

The power supply of 3V is recommended to power this system. A1 and A2 are set up as unity gain buffers. It is easy to configure A1 with the required gain if a gain of greater than one is required. C₁ along with R₁ and R₂ are used to ensure the correct DC operating point at the input of A1. C₄ along with R₅ and R₆ are used to setup the correct DC operating point for A2. C₁, C₃, and C₄ have been selected to give about a 20% droop with a 1 kHz square wave input.

REVISION HISTORY

Changes from Revision B (April 2013) to Revision C	Page
• Changed layout of National Data Sheet to TI format	17

PACKAGING INFORMATION

Orderable Device	Status (1)	Package Type	Package Drawing	Pins	Package Qty	Eco Plan (2)	Lead/Ball Finish	MSL Peak Temp (3)	Op Temp (°C)	Top-Side Markings (4)	Samples
LMV951MK/NOPB	ACTIVE	SOT	DDC	6	1000	Green (RoHS & no Sb/Br)	CU SN	Level-1-260C-UNLIM	-40 to 125	AS3A	Samples
LMV951MKX/NOPB	ACTIVE	SOT	DDC	6	3000	Green (RoHS & no Sb/Br)	CU SN	Level-1-260C-UNLIM	-40 to 125	AS3A	Samples

(1) The marketing status values are defined as follows:

ACTIVE: Product device recommended for new designs.

LIFEBUY: TI has announced that the device will be discontinued, and a lifetime-buy period is in effect.

NRND: Not recommended for new designs. Device is in production to support existing customers, but TI does not recommend using this part in a new design.

PREVIEW: Device has been announced but is not in production. Samples may or may not be available.

OBSOLETE: TI has discontinued the production of the device.

(2) Eco Plan - The planned eco-friendly classification: Pb-Free (RoHS), Pb-Free (RoHS Exempt), or Green (RoHS & no Sb/Br) - please check <http://www.ti.com/productcontent> for the latest availability information and additional product content details.

TBD: The Pb-Free/Green conversion plan has not been defined.

Pb-Free (RoHS): TI's terms "Lead-Free" or "Pb-Free" mean semiconductor products that are compatible with the current RoHS requirements for all 6 substances, including the requirement that lead not exceed 0.1% by weight in homogeneous materials. Where designed to be soldered at high temperatures, TI Pb-Free products are suitable for use in specified lead-free processes.

Pb-Free (RoHS Exempt): This component has a RoHS exemption for either 1) lead-based flip-chip solder bumps used between the die and package, or 2) lead-based die adhesive used between the die and leadframe. The component is otherwise considered Pb-Free (RoHS compatible) as defined above.

Green (RoHS & no Sb/Br): TI defines "Green" to mean Pb-Free (RoHS compatible), and free of Bromine (Br) and Antimony (Sb) based flame retardants (Br or Sb do not exceed 0.1% by weight in homogeneous material)

(3) MSL, Peak Temp. -- The Moisture Sensitivity Level rating according to the JEDEC industry standard classifications, and peak solder temperature.

(4) Multiple Top-Side Markings will be inside parentheses. Only one Top-Side Marking contained in parentheses and separated by a "~" will appear on a device. If a line is indented then it is a continuation of the previous line and the two combined represent the entire Top-Side Marking for that device.

Important Information and Disclaimer: The information provided on this page represents TI's knowledge and belief as of the date that it is provided. TI bases its knowledge and belief on information provided by third parties, and makes no representation or warranty as to the accuracy of such information. Efforts are underway to better integrate information from third parties. TI has taken and continues to take reasonable steps to provide representative and accurate information but may not have conducted destructive testing or chemical analysis on incoming materials and chemicals. TI and TI suppliers consider certain information to be proprietary, and thus CAS numbers and other limited information may not be available for release.

In no event shall TI's liability arising out of such information exceed the total purchase price of the TI part(s) at issue in this document sold by TI to Customer on an annual basis.

TAPE AND REEL INFORMATION

QUADRANT ASSIGNMENTS FOR PIN 1 ORIENTATION IN TAPE

*All dimensions are nominal

Device	Package Type	Package Drawing	Pins	SPQ	Reel Diameter (mm)	Reel Width W1 (mm)	A0 (mm)	B0 (mm)	K0 (mm)	P1 (mm)	W (mm)	Pin1 Quadrant
LMV951MK/NOPB	SOT	DDC	6	1000	178.0	8.4	3.2	3.2	1.4	4.0	8.0	Q3
LMV951MKX/NOPB	SOT	DDC	6	3000	178.0	8.4	3.2	3.2	1.4	4.0	8.0	Q3

TAPE AND REEL BOX DIMENSIONS

*All dimensions are nominal

Device	Package Type	Package Drawing	Pins	SPQ	Length (mm)	Width (mm)	Height (mm)
LMV951MK/NOPB	SOT	DDC	6	1000	210.0	185.0	35.0
LMV951MKX/NOPB	SOT	DDC	6	3000	210.0	185.0	35.0

DDC (R-PDSO-G6)

PLASTIC SMALL-OUTLINE

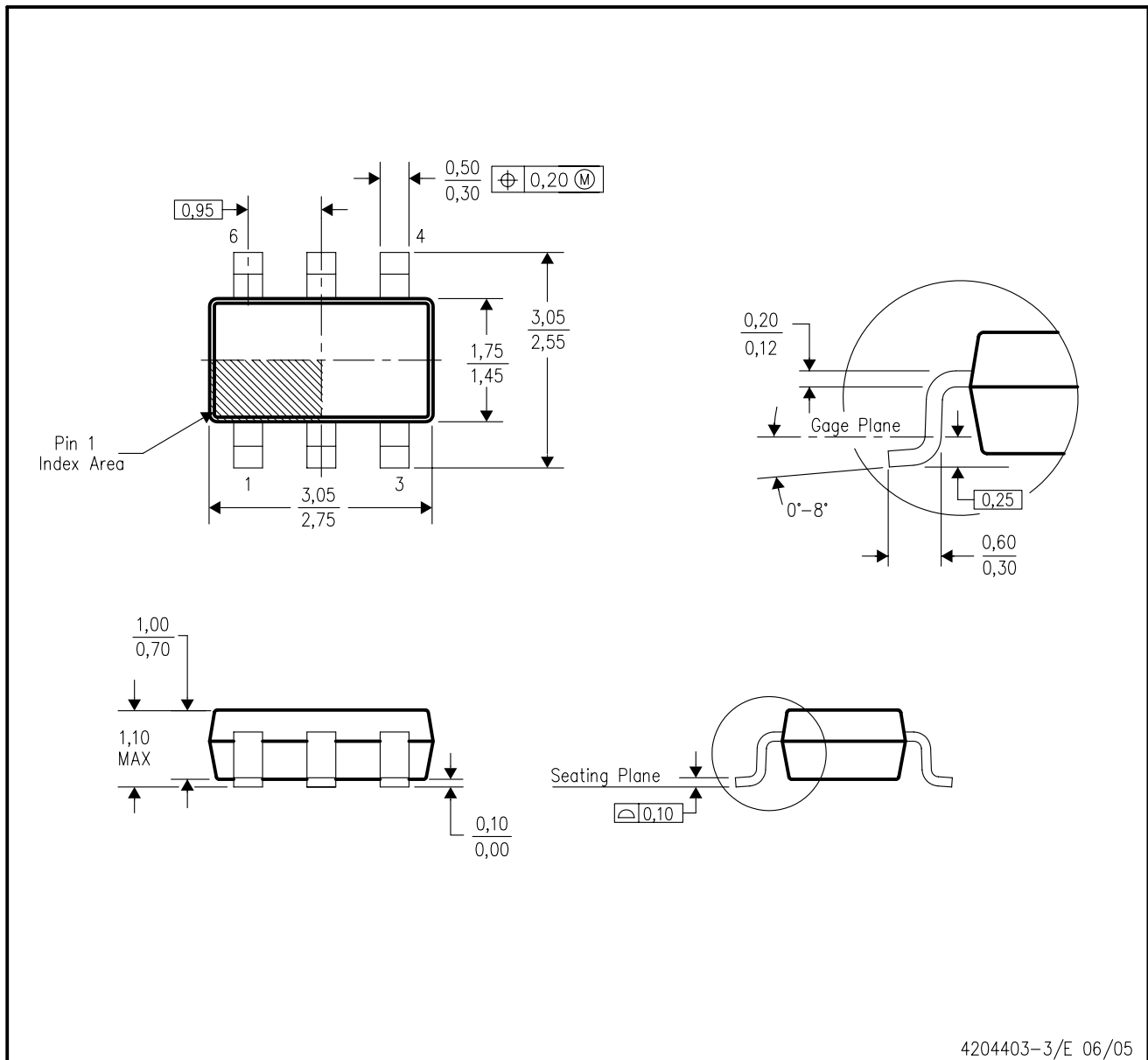

- NOTES:
- All linear dimensions are in millimeters.
 - This drawing is subject to change without notice.
 - Body dimensions do not include mold flash or protrusion.
 - Falls within JEDEC MO-193 variation AA (6 pin).

DDC (R-PDSO-G6)

PLASTIC SMALL OUTLINE

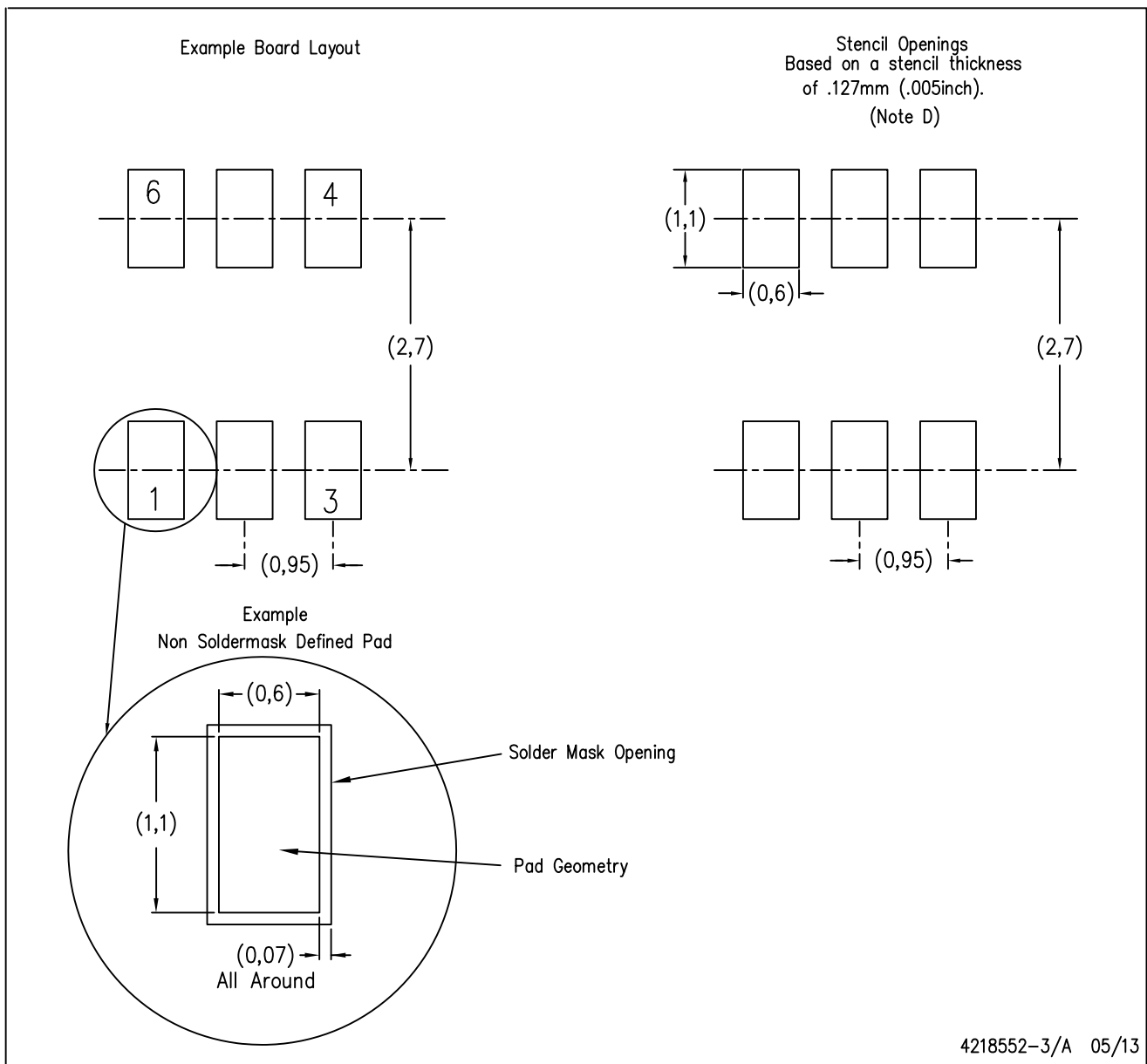

- NOTES:
- A. All linear dimensions are in millimeters.
 - B. This drawing is subject to change without notice.
 - C. Publication IPC-7351 is recommended for alternate designs.
 - D. Laser cutting apertures with trapezoidal walls and also rounding corners will offer better paste release. Customers should contact their board assembly site for stencil design recommendations. Example stencil design based on a 50% volumetric metal load solder paste. Refer to IPC-7525 for other stencil recommendations.

IMPORTANT NOTICE

Texas Instruments Incorporated and its subsidiaries (TI) reserve the right to make corrections, enhancements, improvements and other changes to its semiconductor products and services per JESD46, latest issue, and to discontinue any product or service per JESD48, latest issue. Buyers should obtain the latest relevant information before placing orders and should verify that such information is current and complete. All semiconductor products (also referred to herein as "components") are sold subject to TI's terms and conditions of sale supplied at the time of order acknowledgment.

TI warrants performance of its components to the specifications applicable at the time of sale, in accordance with the warranty in TI's terms and conditions of sale of semiconductor products. Testing and other quality control techniques are used to the extent TI deems necessary to support this warranty. Except where mandated by applicable law, testing of all parameters of each component is not necessarily performed.

TI assumes no liability for applications assistance or the design of Buyers' products. Buyers are responsible for their products and applications using TI components. To minimize the risks associated with Buyers' products and applications, Buyers should provide adequate design and operating safeguards.

TI does not warrant or represent that any license, either express or implied, is granted under any patent right, copyright, mask work right, or other intellectual property right relating to any combination, machine, or process in which TI components or services are used. Information published by TI regarding third-party products or services does not constitute a license to use such products or services or a warranty or endorsement thereof. Use of such information may require a license from a third party under the patents or other intellectual property of the third party, or a license from TI under the patents or other intellectual property of TI.

Reproduction of significant portions of TI information in TI data books or data sheets is permissible only if reproduction is without alteration and is accompanied by all associated warranties, conditions, limitations, and notices. TI is not responsible or liable for such altered documentation. Information of third parties may be subject to additional restrictions.

Resale of TI components or services with statements different from or beyond the parameters stated by TI for that component or service voids all express and any implied warranties for the associated TI component or service and is an unfair and deceptive business practice. TI is not responsible or liable for any such statements.

Buyer acknowledges and agrees that it is solely responsible for compliance with all legal, regulatory and safety-related requirements concerning its products, and any use of TI components in its applications, notwithstanding any applications-related information or support that may be provided by TI. Buyer represents and agrees that it has all the necessary expertise to create and implement safeguards which anticipate dangerous consequences of failures, monitor failures and their consequences, lessen the likelihood of failures that might cause harm and take appropriate remedial actions. Buyer will fully indemnify TI and its representatives against any damages arising out of the use of any TI components in safety-critical applications.

In some cases, TI components may be promoted specifically to facilitate safety-related applications. With such components, TI's goal is to help enable customers to design and create their own end-product solutions that meet applicable functional safety standards and requirements. Nonetheless, such components are subject to these terms.

No TI components are authorized for use in FDA Class III (or similar life-critical medical equipment) unless authorized officers of the parties have executed a special agreement specifically governing such use.

Only those TI components which TI has specifically designated as military grade or "enhanced plastic" are designed and intended for use in military/aerospace applications or environments. Buyer acknowledges and agrees that any military or aerospace use of TI components which have **not** been so designated is solely at the Buyer's risk, and that Buyer is solely responsible for compliance with all legal and regulatory requirements in connection with such use.

TI has specifically designated certain components as meeting ISO/TS16949 requirements, mainly for automotive use. In any case of use of non-designated products, TI will not be responsible for any failure to meet ISO/TS16949.

Products

Audio	www.ti.com/audio
Amplifiers	amplifier.ti.com
Data Converters	dataconverter.ti.com
DLP® Products	www.dlp.com
DSP	dsp.ti.com
Clocks and Timers	www.ti.com/clocks
Interface	interface.ti.com
Logic	logic.ti.com
Power Mgmt	power.ti.com
Microcontrollers	microcontroller.ti.com
RFID	www.ti-rfid.com
OMAP Applications Processors	www.ti.com/omap
Wireless Connectivity	www.ti.com/wirelessconnectivity

Applications

Automotive and Transportation	www.ti.com/automotive
Communications and Telecom	www.ti.com/communications
Computers and Peripherals	www.ti.com/computers
Consumer Electronics	www.ti.com/consumer-apps
Energy and Lighting	www.ti.com/energy
Industrial	www.ti.com/industrial
Medical	www.ti.com/medical
Security	www.ti.com/security
Space, Avionics and Defense	www.ti.com/space-avionics-defense
Video and Imaging	www.ti.com/video

TI E2E Community

e2e.ti.com