

November 2010

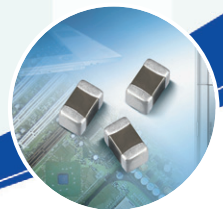

MULTILAYER CERAMIC CAPACITORS

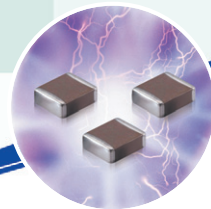

SAMSUNG
ELECTRO-MECHANICS





We, Samsung, declare that our component MLCC is produced in accordance with EU RoHS directive.

1. RoHS Compliance and restriction of Br

The following restricted materials are not used in packaging materials as well as products in compliance with the law and restriction.

- Cd, Pb, Hg, Cr+6, As, Br and the compounds, PCB, asbestos
- Bromic materials : PBBs, PBBOs, PBDO, PBDE, PBB

2. No use of materials breaking Ozone layer

The following ODS materials are not used in our fabrication process.

- ODS material : Freon, Haron, 1-1-1 TCE, CCl4, HCFC

If you want more detailed Information, Please Visit Samsung Electro-mechanics Website
[<http://www.sem.samsung.com>, <http://www.sem1cr.com>]

Please, see the last page of this catalog for our environmental certification list.

CONTENTS

| | | |
|--|----|--|
| Part Numbering System | 4 | Part Numbering System |
| General Capacitors | 6 | General Capacitors |
| High Capacitance Capacitors | 23 | High Capacitance Capacitors |
| Super Small Size Capacitors | 37 | Super Small Size Capacitors |
| Medium-High Voltage Capacitors | 41 | Medium-High Voltage Capacitors |
| Array Type Capacitors | 52 | Array Type Capacitors |
| Low ESL Capacitors | 55 | Low ESL Capacitors |
| Reliability Test Condition | 58 | Reliability Test Condition |
| Premium Capacitors for Automotive Applications | 62 | Premium Capacitors for Automotive Applications |
| Packaging Specification | 78 | Packaging Specification |
| Application Manual for Surface Mounting | 82 | Application Manual for Surface Mounting |

Part Numbering System

CL 10 C 101 J B 8 N N N C
1 2 3 4 5 6 7 8 9 10 11

1. SERIES CODE _____

CL=Multi layer Ceramic Capacitors

2. SIZE CODE — inch(mm) _____

02=01005(0402) 21=0805(2012) 43=1812(4532)
 03=0201(0603) 31=1206(3216) 55=2220(5750)
 05=0402(1005) 32=1210(3225)
 10=0603(1608) 42=1808(4520)

3. DIELECTRIC CODE _____

| Class I | Class II |
|---------|-------------------------------------|
| C=COG | A=X5R F=Y5V B=X7R X=X6S Y=X7S |

4. CAPACITANCE CODE _____

Capacitance expressed in pF. 2 significant digits plus number of zeros.
 example) 106=10 × 10⁶=10000000pF
 For Values < 10pF, Letter R denotes decimal point
 example) 1R5=1.5pF

5. TOLERANCE CODE _____

A=±0.05pF D=±0.5pF J=±5% Z=+80/-20%
 B=±0.1pF F=±1pF, ±1%* K=±10%
 C=±0.25pF G=±2% M=±20%
 *For Values ≤ 10pF, F=±1pF
 Values > 10pF, F=±1%

6. RATED VOLTAGE CODE _____

R=4V O=16V B=50V E=250V H=630V K=3000V
 Q=6.3V A=25V C=100V F=350V I=1000V
 P=10V L=35V D=200V G=500V J=2000V

7. THICKNESS CODE _____

3 = 0.30mm A = 0.65mm F = 1.25mm L = 3.20mm S = 1.35mm
 5 = 0.50mm C = 0.85mm H = 1.60mm M = 1.15mm U = 1.80mm
 8 = 0.80mm D = 1.00mm I = 2.00mm P = 1.15mm V = 2.50mm
 9 = 0.90mm E = 1.10mm J = 2.50mm Q = 1.25mm Y = 1.25mm

8. INNER ELECTRODE / TERMINATION / PLATING CODE _____

A= Normal Product Pd / Ag / Ni barrier / Sn 100%
 N= Normal Product Ni / Cu / Ni barrier / Sn 100%
 G= Normal Product Cu / Cu / Ni barrier / Sn 100%
 L= Low profile Ni / Cu / Ni barrier / Sn 100%
 S= Normal Product Ni/Cu/Ag-Epoxy/Ni barrier / Sn 100%

9. PRODUCT CODE _____

A= Array(2-element) L= LICC
 B= Array(4-element) N= Normal

| Size Code | *Size tolerance | | | |
|-----------|-----------------|------------|------------|------------|
| | 0201(0603) | 0402(1005) | 0603(1608) | 0805(2012) |
| S | ±0.05 | ±0.07 | ±0.07 | |
| Q | ±0.07 | ±0.1 | ±0.15 | ±0.15 |
| R | ±0.1 | ±0.15 | ±0.2 | ±0.2 |
| U | - | ±0.2 | - | - |

10. SPECIAL CODE _____

N= special code

11. PACKAGING CODE _____

B = Bulk O = Cardboard Tape, 10" Reel E = Embossed Type, 7" Reel
 P = Bulk Case D = Cardboard Tape, 13" Reel(10,000ea) F = Embossed Type, 13" Reel
 C = Cardboard Tape, 7" Reel L = Cardboard Tape, 13" Reel(15,000ea) S = Embossed Type, 10" Reel

Class I (Temperature Compensation)

| Symbol | EIA Code | Operation Temperature Range(°C) | Temperature Coefficient Range(ppm/°C) |
|--------|----------|---------------------------------|---------------------------------------|
| C | COG | -55 ~ +125 | 0 ±30 |

*** Class II (High Dielectric Constant)**

| Symbol | EIA Code | Operation Temperature Range(°C) | Capacitance Change(ΔC %) |
|--------|----------|---------------------------------|--------------------------|
| A | X5R | -55 ~ + 85 | ±15 |
| B | X7R | -55 ~ +125 | ±15 |
| X | X6S | -55 ~ +105 | ±22 |
| F | Y5V | -30 ~ + 85 | -82 ~ +22 |
| Y | X7S | -55 ~ +125 | ±22 |

| Series | TC | Capacitance Step | | | | | | | | | | | | | | | | | |
|--------|-------------------|------------------|-----|-----|-----|-----|-----|-----|-----|-----|-----|-----|-----|-----|--|--|-----|--|--|
| | | 1.0 | | | 1.5 | | | 2.2 | | | 3.3 | | | | | | | | |
| E-3 | Y5V | 1.0 | | | 2.2 | | | 4.7 | | | | | | | | | | | |
| E-6 | X5R X7R X6S | 1.0 | | | 1.5 | | | 2.2 | | | 3.3 | | | 4.7 | | | 6.8 | | |
| E-12 | COG | 1.0 | 1.2 | 1.5 | 1.8 | 2.2 | 2.7 | 3.3 | 3.9 | 4.7 | 5.6 | 6.8 | 8.2 | | | | | | |

| Size | Code | Thickness(mm) | Spec(mm) | Size | Code | Thickness(mm) | Spec(mm) |
|-------------|------|---------------|-----------------|------------|------|---------------|----------|
| 01005(0402) | 2 | 0.20 | ±0.02 | 1210(3225) | H | 1.60 | ±0.20 |
| 0201(0603) | 3 | 0.30 | ±0.03 | | U | 1.80 | ±0.20 |
| 0402(1005) | 5 | 0.50 | ±0.05 | | I | 2.00 | ±0.20 |
| 0603(1608) | 5 | 0.50 | +0.0/-0.1 | | J | 2.50 | ±0.20 |
| | 8 | 0.80 | ±0.10 | | V | 2.50 | ±0.30 |
| 0805(2012) | A | 0.65 | ±0.10 | 1808(4520) | F | 1.25 | ±0.20 |
| | C | 0.85 | ±0.10 | | H | 1.60 | ±0.20 |
| | D | 1.00 | ±0.15 | | I | 2.00 | ±0.20 |
| | F | 1.25 | ±0.10 | 1812(4532) | F | 1.25 | ±0.20 |
| | Q | 1.25 | ±0.15 | | H | 1.60 | ±0.20 |
| Y | 1.25 | ±0.2 | I | | 2.00 | ±0.20 | |
| 1206(3216) | C | 0.85 | ±0.15 *±0.10 | | J | 2.50 | ±0.20 |
| | D | 1.00 | ±0.15 | L | 3.20 | ±0.30 | |
| | E | 1.10 | ±0.10 | 2220(5750) | F | 1.25 | ±0.20 |
| | P | 1.15 | ±0.10 | | H | 1.60 | ±0.20 |
| | F | 1.25 | ±0.15 | | I | 2.00 | ±0.20 |
| H | 1.60 | ±0.20 | J | | 2.50 | ±0.20 | |
| 1210(3225) | C | 0.85 | ±0.15 *±0.10 | | L | 3.20 | ±0.30 |
| | 9 | 0.90 | ±0.10 | | | | |
| | M | 1.15 | ±0.10 | | | | |
| | F | 1.25 | ±0.20 | | | | |
| | S | 1.35 | ±0.15 | | | | |

- * Mark is only applicable to "L" code , 12th code in part number.
- Please discuss with sales person with regard to Pd products.

Part Numbering System

General Capacitors

High Capacitance Capacitors

Super Small Size Capacitors

Medium-High Voltage Capacitors

Array Type Capacitors

Low ESL Capacitors

Reliability Test Condition

Premium Capacitors for Automotive Applications

Packaging Specification

Application Manual for Surface Mounting

General Capacitors

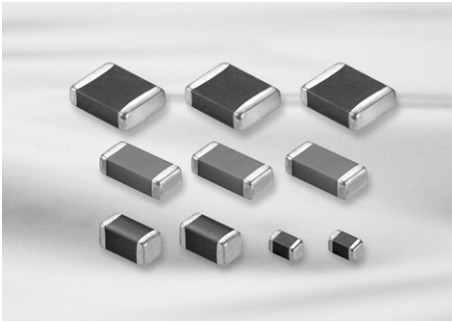

Feature

- Wide selection of size : from 0402 to 2220
- Highly reliable tolerance and high speed automatic chip placement on PCBs
- Wide capacitance range
- Wide temperature compensation and voltage range : from COG to Y5V and from 6.3V to 50V
- Highly reliable performance
- Highly resistant termination metal
- Tape & reel for surface mount assembly

Application

- HHP, DSC, DVC, LCD, TV, Car Navigation, Memory Module, PDA, Game Machine
- Tuner (Product code C is suitable.)
- ※ Medical, Aviation, Automobile device should be following a special specification.

Structure and Dimensions

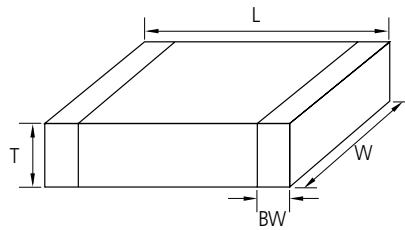

| Size Code | EIA Code | Dimension(mm) | | | | |
|-----------|----------|---------------|-----------|---------------|----------------|---------------|
| | | L | W | T | Thickness Code | BW |
| 05 | 0402 | 1.00±0.05 | 0.50±0.05 | 0.50±0.05 | 5 | 0.2+0.15/-0.1 |
| 10 | 0603 | 1.60±0.10 | 0.80±0.10 | 0.50+0.0/-0.1 | 5 | 0.30±0.20 |
| | | | | 0.80±0.10 | 8 | |
| 21 | 0805 | 2.00±0.10 | 1.25±0.10 | 0.85±0.10 | C | 0.5+0.2/-0.3 |
| | | | | 1.25±0.10 | F | |
| | | | | 1.25±0.15 | Q | |
| 21 | 0805 | 2.00±0.15 | 1.25±0.15 | 1.25±0.15 | Y | 0.5+0.2/-0.3 |
| | | | | 1.25±0.20 | Y | |
| | | | | 1.25±0.20 | Y | |
| 31 | 1206 | 3.20±0.20 | 1.60±0.20 | 0.60±0.10 | 6 | 0.50±0.30 |
| | | | | 0.85±0.15 | C | |
| | | | | 0.85±0.10(*) | C | |
| | | | | 1.15±0.10 | P | |
| 31 | 1206 | 3.20±0.15 | 1.60±0.15 | 1.25±0.15 | F | 0.50±0.30 |
| | | | | 1.60±0.20 | H | |
| | | | | 1.60±0.20 | H | |
| 32 | 1210 | 3.20±0.30 | 2.50±0.20 | 0.85±0.15 | C | 0.60±0.30 |
| | | | | 0.85±0.10(*) | C | |
| | | | | 0.90±0.10 | 9 | |
| | | | | 1.60±0.20 | H | |
| | | | | 1.80±0.20 | U | |
| | | | | 2.00±0.20 | I | |
| 32 | 1210 | 3.20±0.30 | 2.50±0.20 | 2.50±0.20 | J | 0.60±0.30 |
| | | | | 2.50±0.30 | v | |
| 42 | 1808 | 4.50±0.40 | 2.00±0.20 | 2.00±0.20 | I | 0.80±0.30 |
| 43 | 1812 | 4.50±0.40 | 3.20±0.30 | 3.20±0.30 | L | 0.80±0.30 |
| 55 | 2220 | 5.70±0.40 | 5.00±0.40 | 3.20±0.30 | L | 1.00±0.30 |

■ * Mark is only applicable to "L" code , 12th code in part number.

General Capacitors Table (COG)

| Size(mm) | Vr(V) | Capacitance | | | | | | | | | | | | | | | | | | | | | |
|------------|-------|--------------------------|---|----|----|----|-----|-----|-----|-----|-----|---|-----|-----|-----|-----|----|----|----|----|----|----|-----|
| | | pF | | | | | | | | | nF | | | | | | | | | | | | |
| | | 0.5 | 1 | 10 | 22 | 47 | 100 | 220 | 330 | 470 | 560 | 1 | 2.2 | 3.3 | 4.7 | 6.8 | 10 | 22 | 27 | 33 | 47 | 68 | 100 |
| 0402(1005) | 25 | [Capacitance range bars] | | | | | | | | | | | | | | | | | | | | | |
| | 50 | [Capacitance range bars] | | | | | | | | | | | | | | | | | | | | | |
| 0603(1608) | 25 | [Capacitance range bars] | | | | | | | | | | | | | | | | | | | | | |
| | 50 | [Capacitance range bars] | | | | | | | | | | | | | | | | | | | | | |
| 0805(2012) | 25 | [Capacitance range bars] | | | | | | | | | | | | | | | | | | | | | |
| | 50 | [Capacitance range bars] | | | | | | | | | | | | | | | | | | | | | |
| 1206(3216) | 16 | [Capacitance range bars] | | | | | | | | | | | | | | | | | | | | | |
| | 25 | [Capacitance range bars] | | | | | | | | | | | | | | | | | | | | | |
| | 50 | [Capacitance range bars] | | | | | | | | | | | | | | | | | | | | | |
| 1210(3225) | 50 | [Capacitance range bars] | | | | | | | | | | | | | | | | | | | | | |
| 1812(4532) | 25 | [Capacitance range bars] | | | | | | | | | | | | | | | | | | | | | |
| | 50 | [Capacitance range bars] | | | | | | | | | | | | | | | | | | | | | |
| 2220(5750) | 50 | [Capacitance range bars] | | | | | | | | | | | | | | | | | | | | | |

- Part Numbering System
- General Capacitors
- High Capacitance Capacitors
- Super Small Size Capacitors
- Medium-High Voltage Capacitors
- Array Type Capacitors
- Low ESL Capacitors
- Reliability Test Condition
- Premium Capacitors for Automotive Applications
- Packaging Specification
- Application Manual for Surface Mounting

General Capacitors Table_Low Profile (X5R)

| Size(mm) | Tmax (mm) | Vr(V) | Capacitance (uF) | | | | | | |
|------------|-----------|-------|------------------|------------|------------|----|----|------------|----|
| | | | 1 | 2.2 | 4.7 | 10 | 22 | 33 | 47 |
| 0402(1005) | 0.3 | 6.3 | X6S | | | | | | |
| | | 10 | | | | | | | |
| | | 16 | | | | | | | |
| 0603(1608) | 0.5 | 6.3 | | | | | | | |
| | | 10 | | | | | | | |
| | | 16 | | | | | | | |
| | | 25 | | | | | | | |
| 0805(2012) | 0.7 | 10 | | | | | | | |
| | | 16 | | | | | | | |
| | | 25 | | | | | | | |
| | 0.95 | 4 | | | | | | (Tmax=1.0) | |
| | | 6.3 | | | | | | (Tmax=1.0) | |
| 10 | | | | | | | | | |
| 16 | | | | | | | | | |
| 25 | | | | | X6S | | | | |
| 1206(3216) | 0.7 | 10 | | | | | | | |
| | 0.95 | 6.3 | | | | | | | |
| | | 10 | | | | | | | |
| | | 16 | | | | | | | |
| | | 25 | | | X6S | | | | |
| | | 50 | | (Tmax=1.0) | (Tmax=1.0) | | | | |
| 1210(3225) | 0.95 | 16 | | | | | | | |
| | 2.0 | 25 | | | | | | | |
| | | 35 | | | | | | | |
| | | 50 | | | | | | | |

- Part Numbering System
- General Capacitors
- High Capacitance Capacitors
- Super Small Size Capacitors
- Medium-High Voltage Capacitors
- Array Type Capacitors
- Low ESL Capacitors
- Reliability Test Condition
- Premium Capacitors for Automotive Applications
- Packaging Specification
- Application Manual for Surface Mounting

General Capacitors Table (X7R)

| Size(mm) | Vr(V) | Capacitance (uF) | | | | | | | | | |
|------------|-------|------------------|------|------|---|-----|-----|----|----|----|-----|
| | | 0.1 | 0.22 | 0.47 | 1 | 2.2 | 4.7 | 10 | 22 | 47 | 100 |
| 0402(1005) | 6.3 | 0.1 | 0.22 | 0.47 | 1 | 2.2 | 4.7 | 10 | 22 | 47 | 100 |
| | 10 | 0.1 | 0.22 | 0.47 | 1 | 2.2 | 4.7 | 10 | 22 | 47 | 100 |
| | 16 | 0.1 | 0.22 | 0.47 | 1 | 2.2 | 4.7 | 10 | 22 | 47 | 100 |
| 0603(1608) | 6.3 | 0.1 | 0.22 | 0.47 | 1 | 2.2 | 4.7 | 10 | 22 | 47 | 100 |
| | 10 | 0.1 | 0.22 | 0.47 | 1 | 2.2 | 4.7 | 10 | 22 | 47 | 100 |
| | 16 | 0.1 | 0.22 | 0.47 | 1 | 2.2 | 4.7 | 10 | 22 | 47 | 100 |
| | 25 | 0.1 | 0.22 | 0.47 | 1 | 2.2 | 4.7 | 10 | 22 | 47 | 100 |
| | 50 | 0.1 | 0.22 | 0.47 | 1 | 2.2 | 4.7 | 10 | 22 | 47 | 100 |
| 0805(2012) | 6.3 | 0.1 | 0.22 | 0.47 | 1 | 2.2 | 4.7 | 10 | 22 | 47 | 100 |
| | 10 | 0.1 | 0.22 | 0.47 | 1 | 2.2 | 4.7 | 10 | 22 | 47 | 100 |
| | 16 | 0.1 | 0.22 | 0.47 | 1 | 2.2 | 4.7 | 10 | 22 | 47 | 100 |
| | 25 | 0.1 | 0.22 | 0.47 | 1 | 2.2 | 4.7 | 10 | 22 | 47 | 100 |
| | 35 | 0.1 | 0.22 | 0.47 | 1 | 2.2 | 4.7 | 10 | 22 | 47 | 100 |
| | 50 | 0.1 | 0.22 | 0.47 | 1 | 2.2 | 4.7 | 10 | 22 | 47 | 100 |
| 1206(3216) | 6.3 | 0.1 | 0.22 | 0.47 | 1 | 2.2 | 4.7 | 10 | 22 | 47 | 100 |
| | 10 | 0.1 | 0.22 | 0.47 | 1 | 2.2 | 4.7 | 10 | 22 | 47 | 100 |
| | 16 | 0.1 | 0.22 | 0.47 | 1 | 2.2 | 4.7 | 10 | 22 | 47 | 100 |
| | 25 | 0.1 | 0.22 | 0.47 | 1 | 2.2 | 4.7 | 10 | 22 | 47 | 100 |
| | 35 | 0.1 | 0.22 | 0.47 | 1 | 2.2 | 4.7 | 10 | 22 | 47 | 100 |
| | 50 | 0.1 | 0.22 | 0.47 | 1 | 2.2 | 4.7 | 10 | 22 | 47 | 100 |
| 1210(3225) | 6.3 | 0.1 | 0.22 | 0.47 | 1 | 2.2 | 4.7 | 10 | 22 | 47 | 100 |
| | 10 | 0.1 | 0.22 | 0.47 | 1 | 2.2 | 4.7 | 10 | 22 | 47 | 100 |
| | 16 | 0.1 | 0.22 | 0.47 | 1 | 2.2 | 4.7 | 10 | 22 | 47 | 100 |
| | 25 | 0.1 | 0.22 | 0.47 | 1 | 2.2 | 4.7 | 10 | 22 | 47 | 100 |
| | 50 | 0.1 | 0.22 | 0.47 | 1 | 2.2 | 4.7 | 10 | 22 | 47 | 100 |

- Part Numbering System
- General Capacitors
- High Capacitance Capacitors
- Super Small Size Capacitors
- Medium-High Voltage Capacitors
- Array Type Capacitors
- Low ESL Capacitors
- Reliability Test Condition
- Premium Capacitors for Automotive Applications
- Packaging Specification
- Application Manual for Surface Mounting

Product Lineup (General Capacitors-C0G)

| | Part Number | Size L×W (mm) | Capacitance | Rated Voltage (Vdc) | Capacitance Tolerance | Thickness Max. (mm) |
|----|------------------|---------------|-------------|---------------------|-----------------------|---------------------|
| 1 | CL05C0R5CB5NNN □ | 1.00×0.50 | 0.5pF | 50 | ±0.25pF | 0.55 |
| 2 | CL05CR75CB5NNN □ | | 0.75pF | 50 | ±0.25pF | 0.55 |
| 3 | CL05C010CB5NNN □ | | 1.0pF | 50 | ±0.25pF | 0.55 |
| 4 | CL05C1R2CB5NNN □ | | 1.2pF | 50 | ±0.25pF | 0.55 |
| 5 | CL05C1R5CB5NNN □ | | 1.5pF | 50 | ±0.25pF | 0.55 |
| 6 | CL05C1R8CB5NNN □ | | 1.8pF | 50 | ±0.25pF | 0.55 |
| 7 | CL05C020CB5NNN □ | | 2.0pF | 50 | ±0.25pF | 0.55 |
| 8 | CL05C2R2CB5NNN □ | | 2.2pF | 50 | ±0.25pF | 0.55 |
| 9 | CL05C2R4CB5NNN □ | | 2.4pF | 50 | ±0.25pF | 0.55 |
| 10 | CL05C2R5CB5NNN □ | | 2.5pF | 50 | ±0.25pF | 0.55 |
| 11 | CL05C2R7CB5NNN □ | | 2.7pF | 50 | ±0.25pF | 0.55 |
| 12 | CL05C030CB5NNN □ | | 3.0pF | 50 | ±0.25pF | 0.55 |
| 13 | CL05C3R3CB5NNN □ | | 3.3pF | 50 | ±0.25pF | 0.55 |
| 14 | CL05C3R5CB5NNN □ | | 3.5pF | 50 | ±0.25pF | 0.55 |
| 15 | CL05C3R6CB5NNN □ | | 3.6pF | 50 | ±0.25pF | 0.55 |
| 16 | CL05C3R9CB5NNN □ | | 3.9pF | 50 | ±0.25pF | 0.55 |
| 17 | CL05C040CB5NNN □ | | 4.0pF | 50 | ±0.25pF | 0.55 |
| 18 | CL05C4R3CB5NNN □ | | 4.3pF | 50 | ±0.25pF | 0.55 |
| 19 | CL05C4R7CB5NNN □ | | 4.7pF | 50 | ±0.25pF | 0.55 |
| 20 | CL05C050DB5NNN □ | | 5.0pF | 50 | ±0.5pF | 0.55 |
| 21 | CL05C5R6DB5NNN □ | | 5.6pF | 50 | ±0.5pF | 0.55 |
| 22 | CL05C060DB5NNN □ | | 6.0pF | 50 | ±0.5pF | 0.55 |
| 23 | CL05C6R2DB5NNN □ | | 6.2pF | 50 | ±0.5pF | 0.55 |
| 24 | CL05C6R8DB5NNN □ | | 6.8pF | 50 | ±0.5pF | 0.55 |
| 25 | CL05C070DB5NNN □ | | 7.0pF | 50 | ±0.5pF | 0.55 |
| 26 | CL05C080DB5NNN □ | | 8.0pF | 50 | ±0.5pF | 0.55 |
| 27 | CL05C8R2DB5NNN □ | | 8.2pF | 50 | ±0.5pF | 0.55 |
| 28 | CL05C090DB5NNN □ | | 9.0pF | 50 | ±0.5pF | 0.55 |
| 29 | CL05C9R1DB5NNN □ | | 9.1pF | 50 | ±0.5pF | 0.55 |
| 30 | CL05C100JB5NNN □ | | 10pF | 50 | ±5% | 0.55 |
| 31 | CL05C110JB5NNN □ | | 11pF | 50 | ±5% | 0.55 |
| 32 | CL05C120JB5NNN □ | | 12pF | 50 | ±5% | 0.55 |
| 33 | CL05C130JB5NNN □ | | 13pF | 50 | ±5% | 0.55 |
| 34 | CL05C150JB5NNN □ | | 15pF | 50 | ±5% | 0.55 |
| 35 | CL05C160JB5NNN □ | | 16pF | 50 | ±5% | 0.55 |
| 36 | CL05C180JB5NNN □ | | 18pF | 50 | ±5% | 0.55 |
| 37 | CL05C200JB5NNN □ | | 20pF | 50 | ±5% | 0.55 |
| 38 | CL05C220JA5NNN □ | | 22pF | 25 | ±5% | 0.55 |
| 39 | CL05C220JB5NNN □ | | 22pF | 50 | ±5% | 0.55 |
| 40 | CL05C240JB5NNN □ | | 24pF | 50 | ±5% | 0.55 |
| 41 | CL05C270JB5NNN □ | | 27pF | 50 | ±5% | 0.55 |
| 42 | CL05C270JA5NNN □ | | 27pF | 25 | ±5% | 0.55 |
| 43 | CL05C300JB5NNN □ | | 30pF | 50 | ±5% | 0.55 |
| 44 | CL05C330JB5NNN □ | | 33pF | 50 | ±5% | 0.55 |
| 45 | CL05C360JB5NNN □ | | 36pF | 50 | ±5% | 0.55 |
| 46 | CL05C390JB5NNN □ | | 39pF | 50 | ±5% | 0.55 |
| 47 | CL05C430JB5NNN □ | | 43pF | 50 | ±5% | 0.55 |
| 48 | CL05C470JB5NNN □ | | 47pF | 50 | ±5% | 0.55 |
| 49 | CL05C510JB5NNN □ | | 51pF | 50 | ±5% | 0.55 |
| 50 | CL05C560JB5NNN □ | | 56pF | 50 | ±5% | 0.55 |

※ □ mark means packaging code. If you want to learn the code or quantity in detail, please see p80.

- Part Numbering System
- General Capacitors
- High Capacitance Capacitors
- Super Small Size Capacitors
- Medium-High Voltage Capacitors
- Array Type Capacitors
- Low ESL Capacitors
- Reliability Test Condition
- Premium Capacitors for Automotive Applications
- Packaging Specification
- Application Manual for Surface Mounting



Product Lineup (General Capacitors-C0G)

| | Part Number | Size L×W (mm) | Capacitance | Rated Voltage (Vdc) | Capacitance Tolerance | Thickness Max. (mm) |
|----|------------------|---------------|-------------|---------------------|-----------------------|---------------------|
| 51 | CL05C620JB5NNN □ | 1.00×0.50 | 62pF | 50 | ±5% | 0.55 |
| 52 | CL05C680JB5NNN □ | | 68pF | 50 | ±5% | 0.55 |
| 53 | CL05C750JB5NNN □ | | 75pF | 50 | ±5% | 0.55 |
| 54 | CL05C820JB5NNN □ | | 82pF | 50 | ±5% | 0.55 |
| 55 | CL05C910JB5NNN □ | | 91pF | 50 | ±5% | 0.55 |
| 56 | CL05C101JB5NNN □ | | 100pF | 50 | ±5% | 0.55 |
| 57 | CL05C121JB5NNN □ | | 120pF | 50 | ±5% | 0.55 |
| 58 | CL05C151JB5NNN □ | | 150pF | 50 | ±5% | 0.55 |
| 59 | CL05C181JB5NNN □ | | 180pF | 50 | ±5% | 0.55 |
| 60 | CL05C201JB5NNN □ | | 200pF | 50 | ±5% | 0.55 |
| 61 | CL05C221JB5NNN □ | | 220pF | 50 | ±5% | 0.55 |
| 62 | CL05C271JB5NNN □ | | 270pF | 50 | ±5% | 0.55 |
| 63 | CL05C331JB5NNN □ | | 330pF | 50 | ±5% | 0.55 |
| 64 | CL05C391JB5NNN □ | | 390pF | 50 | ±5% | 0.55 |
| 65 | CL05C471JB5NNN □ | | 470pF | 50 | ±5% | 0.55 |
| 66 | CL05C471JO5NNN □ | | 470pF | 16 | ±5% | 0.55 |
| 67 | CL05C681JB5NNN □ | | 680pF | 50 | ±5% | 0.55 |
| 68 | CL05C821JB5NNN □ | | 820pF | 50 | ±5% | 0.55 |
| 69 | CL05C102JB5NNN □ | | 1nF | 50 | ±5% | 0.55 |
| 70 | CL05C102JA5NNN □ | | 1nF | 25 | ±5% | 0.55 |
| 71 | CL05C102JO5NNN □ | | 1nF | 16 | ±5% | 0.55 |
| 1 | CL10C0R3CB8NNN □ | 1.60×0.80 | 0.3pF | 50 | ±0.25pF | 0.90 |
| 2 | CL10C0R5CB8NNN □ | | 0.5pF | 50 | ±0.25pF | 0.90 |
| 3 | CL10CR75CB8NNN □ | | 0.75pF | 50 | ±0.25pF | 0.90 |
| 4 | CL10C010CB8NNN □ | | 1.0pF | 50 | ±0.25pF | 0.90 |
| 5 | CL10C1R2CB8NNN □ | | 1.2pF | 50 | ±0.25pF | 0.90 |
| 6 | CL10C1R5CB8NNN □ | | 1.5pF | 50 | ±0.25pF | 0.90 |
| 7 | CL10C1R8CB8NNN □ | | 1.8pF | 50 | ±0.25pF | 0.90 |
| 8 | CL10C020CB8NNN □ | | 2.0pF | 50 | ±0.25pF | 0.90 |
| 9 | CL10C2R2CB8NNN □ | | 2.2pF | 50 | ±0.25pF | 0.90 |
| 10 | CL10C2R4CB8NNN □ | | 2.4pF | 50 | ±0.25pF | 0.90 |
| 11 | CL10C2R5CB8NNN □ | | 2.5pF | 50 | ±0.25pF | 0.90 |
| 12 | CL10C2R7CB8NNN □ | | 2.7pF | 50 | ±0.25pF | 0.90 |
| 13 | CL10C030CB8NNN □ | | 3.0pF | 50 | ±0.25pF | 0.90 |
| 14 | CL10C3R3CB8NNN □ | | 3.3pF | 50 | ±0.25pF | 0.90 |
| 15 | CL10C3R5CB8NNN □ | | 3.5pF | 50 | ±0.25pF | 0.90 |
| 16 | CL10C3R6CB8NNN □ | | 3.6pF | 50 | ±0.25pF | 0.90 |
| 17 | CL10C3R9CB8NNN □ | | 3.9pF | 50 | ±0.25pF | 0.90 |
| 18 | CL10C040CB8NNN □ | | 4.0pF | 50 | ±0.25pF | 0.90 |
| 19 | CL10C4R3CB8NNN □ | | 4.3pF | 50 | ±0.25pF | 0.90 |
| 20 | CL10C4R7CB8NNN □ | | 4.7pF | 50 | ±0.25pF | 0.90 |
| 21 | CL10C050DB8NNN □ | | 5.0pF | 50 | ±0.5pF | 0.90 |
| 22 | CL10C5R6DB8NNN □ | | 5.6pF | 50 | ±0.5pF | 0.90 |
| 23 | CL10C060DB8NNN □ | | 6.0pF | 50 | ±0.5pF | 0.90 |
| 24 | CL10C6R2DB8NNN □ | | 6.2pF | 50 | ±0.5pF | 0.90 |
| 25 | CL10C6R8DB8NNN □ | | 6.8pF | 50 | ±0.5pF | 0.90 |
| 26 | CL10C070DB8NNN □ | | 7.0pF | 50 | ±0.5pF | 0.90 |
| 27 | CL10C7R5DB8NNN □ | | 7.5pF | 50 | ±0.5pF | 0.90 |
| 28 | CL10C080DB8NNN □ | | 8.0pF | 50 | ±0.5pF | 0.90 |
| 29 | CL10C8R2DB8NNN □ | | 8.2pF | 50 | ±0.5pF | 0.90 |

※ □ mark means packaging code. If you want to learn the code or quantity in detail, please see p80.

Product Lineup (General Capacitors-C0G)

| | Part Number | Size L×W (mm) | Capacitance | Rated Voltage (Vdc) | Capacitance Tolerance | Thickness Max. (mm) |
|----|------------------|---------------|-------------|---------------------|-----------------------|---------------------|
| 30 | CL10C090DB8NNN □ | 1.60×0.80 | 9.0pF | 50 | ±0.5pF | 0.90 |
| 31 | CL10C9R1DB8NNN □ | | 9.1pF | 50 | ±0.5pF | 0.90 |
| 32 | CL10C100JB8NNN □ | | 10pF | 50 | ±5% | 0.90 |
| 33 | CL10C110JB8NNN □ | | 11pF | 50 | ±5% | 0.90 |
| 34 | CL10C120JB8NNN □ | | 12pF | 50 | ±5% | 0.90 |
| 35 | CL10C130JB8NNN □ | | 13pF | 50 | ±5% | 0.90 |
| 36 | CL10C140JB8NNN □ | | 14pF | 50 | ±5% | 0.90 |
| 37 | CL10C150JB8NNN □ | | 15pF | 50 | ±5% | 0.90 |
| 38 | CL10C160JB8NNN □ | | 16pF | 50 | ±5% | 0.90 |
| 39 | CL10C180JB8NNN □ | | 18pF | 50 | ±5% | 0.90 |
| 40 | CL10C200JB8NNN □ | | 20pF | 50 | ±5% | 0.90 |
| 41 | CL10C220JB8NNN □ | | 22pF | 50 | ±5% | 0.90 |
| 42 | CL10C240JB8NNN □ | | 24pF | 50 | ±5% | 0.90 |
| 43 | CL10C250JB8NNN □ | | 25pF | 50 | ±5% | 0.90 |
| 44 | CL10C270JB8NNN □ | | 27pF | 50 | ±5% | 0.90 |
| 45 | CL10C300JB8NNN □ | | 30pF | 50 | ±5% | 0.90 |
| 46 | CL10C330JB8NNN □ | | 33pF | 50 | ±5% | 0.90 |
| 47 | CL10C360JB8NNN □ | | 36pF | 50 | ±5% | 0.90 |
| 48 | CL10C390JB8NNN □ | | 39pF | 50 | ±5% | 0.90 |
| 49 | CL10C430JB8NNN □ | | 43pF | 50 | ±5% | 0.90 |
| 50 | CL10C470JB8NNN □ | | 47pF | 50 | ±5% | 0.90 |
| 51 | CL10C510JB8NNN □ | | 51pF | 50 | ±5% | 0.90 |
| 52 | CL10C560JB8NNN □ | | 56pF | 50 | ±5% | 0.90 |
| 53 | CL10C620JB8NNN □ | | 62pF | 50 | ±5% | 0.90 |
| 54 | CL10C680JB8NNN □ | | 68pF | 50 | ±5% | 0.90 |
| 55 | CL10C750JB8NNN □ | | 75pF | 50 | ±5% | 0.90 |
| 56 | CL10C820JB8NNN □ | | 82pF | 50 | ±5% | 0.90 |
| 57 | CL10C910JB8NNN □ | | 91pF | 50 | ±5% | 0.90 |
| 58 | CL10C101JB8NNN □ | | 100pF | 50 | ±5% | 0.90 |
| 59 | CL10C111JB8NNN □ | 110pF | 50 | ±5% | 0.90 | |
| 60 | CL10C121JB8NNN □ | 120pF | 50 | ±5% | 0.90 | |
| 61 | CL10C131JB8NNN □ | 130pF | 50 | ±5% | 0.90 | |
| 62 | CL10C151JB8NNN □ | 150pF | 50 | ±5% | 0.90 | |
| 63 | CL10C161JB8NNN □ | 160pF | 50 | ±5% | 0.90 | |
| 64 | CL10C181JB8NNN □ | 180pF | 50 | ±5% | 0.90 | |
| 65 | CL10C201JB8NNN □ | 200pF | 50 | ±5% | 0.90 | |
| 66 | CL10C221JB8NNN □ | 220pF | 50 | ±5% | 0.90 | |
| 67 | CL10C241JB8NNN □ | 240pF | 50 | ±5% | 0.90 | |
| 68 | CL10C271JB8NNN □ | 270pF | 50 | ±5% | 0.90 | |
| 69 | CL10C301JB8NNN □ | 300pF | 50 | ±5% | 0.90 | |
| 70 | CL10C331JB8NNN □ | 330pF | 50 | ±5% | 0.90 | |
| 71 | CL10C361JB8NNN □ | 360pF | 50 | ±5% | 0.90 | |
| 72 | CL10C391JB8NNN □ | 390pF | 50 | ±5% | 0.90 | |
| 73 | CL10C431JB8NNN □ | 430pF | 50 | ±5% | 0.90 | |
| 74 | CL10C471JB8NNN □ | 470pF | 50 | ±5% | 0.90 | |
| 75 | CL10C511JB8NNN □ | 510pF | 50 | ±5% | 0.90 | |
| 76 | CL10C561JB8NNN □ | 560pF | 50 | ±5% | 0.90 | |
| 77 | CL10C621JB8NNN □ | 620pF | 50 | ±5% | 0.90 | |
| 78 | CL10C681JB8NNN □ | 680pF | 50 | ±5% | 0.90 | |
| 79 | CL10C751JB8NNN □ | 750pF | 50 | ±5% | 0.90 | |

- Part Numbering System
- General Capacitors
- High Capacitance Capacitors
- Super Small Size Capacitors
- Medium-High Voltage Capacitors
- Array Type Capacitors
- Low ESL Capacitors
- Reliability Test Condition
- Premium Capacitors for Automotive Applications
- Packaging Specification
- Application Manual for Surface Mounting

※ □ mark means packaging code. If you want to learn the code or quantity in detail, please see p80.



Product Lineup (General Capacitors-C0G)

| | Part Number | Size L×W (mm) | Capacitance | Rated Voltage (Vdc) | Capacitance Tolerance | Thickness Max. (mm) |
|----|------------------|---------------|-------------|---------------------|-----------------------|---------------------|
| 80 | CL10C821JB8NNN □ | 1.60×0.80 | 820pF | 50 | ±5% | 0.90 |
| 81 | CL10C102JB8NNN □ | | 1nF | 50 | ±5% | 0.90 |
| 82 | CL10C182JB8NNN □ | | 1.8nF | 50 | ±5% | 0.90 |
| 83 | CL10C222JB8NNN □ | | 2.2nF | 50 | ±5% | 0.90 |
| 84 | CL10C562JB8NNN □ | | 5.6nF | 50 | ±5% | 0.90 |
| 1 | CL21CR47CBANNN □ | 2.00×1.25 | 0.47pF | 50 | ±0.25pF | 0.75 |
| 2 | CL21C0R5CBANNN □ | | 0.5pF | 50 | ±0.25pF | 0.75 |
| 3 | CL21C010CBANNN □ | | 1.0pF | 50 | ±0.25pF | 0.75 |
| 4 | CL21C1R2CBANNN □ | | 1.2pF | 50 | ±0.25pF | 0.75 |
| 5 | CL21C1R5CBANNN □ | | 1.5pF | 50 | ±0.25pF | 0.75 |
| 6 | CL21C1R8CBANNN □ | | 1.8pF | 50 | ±0.25pF | 0.75 |
| 7 | CL21C020CBANNN □ | | 2.0pF | 50 | ±0.25pF | 0.75 |
| 8 | CL21C2R2CBANNN □ | | 2.2pF | 50 | ±0.25pF | 0.75 |
| 9 | CL21C2R4CBANNN □ | | 2.4pF | 50 | ±0.25pF | 0.75 |
| 10 | CL21C2R5CBANNN □ | | 2.5pF | 50 | ±0.25pF | 0.75 |
| 11 | CL21C2R7CBANNN □ | | 2.7pF | 50 | ±0.25pF | 0.75 |
| 12 | CL21C030CBANNN □ | | 3.0pF | 50 | ±0.25pF | 0.75 |
| 13 | CL21C3R2CBANNN □ | | 3.2pF | 50 | ±0.25pF | 0.75 |
| 14 | CL21C3R3CBANNN □ | | 3.3pF | 50 | ±0.25pF | 0.75 |
| 15 | CL21C3R6CBANNN □ | | 3.6pF | 50 | ±0.25pF | 0.75 |
| 16 | CL21C3R9CBANNN □ | | 3.9pF | 50 | ±0.25pF | 0.75 |
| 17 | CL21C040CBANNN □ | | 4.0pF | 50 | ±0.25pF | 0.75 |
| 18 | CL21C4R7CBANNN □ | | 4.7pF | 50 | ±0.25pF | 0.75 |
| 19 | CL21C5R6DBANNN □ | | 5.6pF | 50 | ±0.5pF | 0.75 |
| 20 | CL21C060DBANNN □ | | 6.0pF | 50 | ±0.5pF | 0.75 |
| 21 | CL21C6R8DBANNN □ | | 6.8pF | 50 | ±0.5pF | 0.75 |
| 22 | CL21C070DBANNN □ | | 7.0pF | 50 | ±0.5pF | 0.75 |
| 23 | CL21C7R5DBANNN □ | | 7.5pF | 50 | ±0.5pF | 0.75 |
| 24 | CL21C080DBANNN □ | | 8.0pF | 50 | ±0.5pF | 0.75 |
| 25 | CL21C8R2DBANNN □ | | 8.2pF | 50 | ±0.5pF | 0.75 |
| 26 | CL21C090DBANNN □ | | 9.0pF | 50 | ±0.5pF | 0.75 |
| 27 | CL21C100JBANNN □ | | 10pF | 50 | ±5% | 0.75 |
| 28 | CL21C120JBANNN □ | | 12pF | 50 | ±5% | 0.75 |
| 29 | CL21C130JBANNN □ | | 13pF | 50 | ±5% | 0.75 |
| 30 | CL21C140JBANNN □ | | 14pF | 50 | ±5% | 0.75 |
| 31 | CL21C150JBANNN □ | | 15pF | 50 | ±5% | 0.75 |
| 32 | CL21C160JBANNN □ | | 16pF | 50 | ±5% | 0.75 |
| 33 | CL21C180JBANNN □ | | 18pF | 50 | ±5% | 0.75 |
| 34 | CL21C200JBANNN □ | | 20pF | 50 | ±5% | 0.75 |
| 35 | CL21C220JBANNN □ | | 22pF | 50 | ±5% | 0.75 |
| 36 | CL21C240JBANNN □ | | 24pF | 50 | ±5% | 0.75 |
| 37 | CL21C250JBANNN □ | | 25pF | 50 | ±5% | 0.75 |
| 38 | CL21C270JBANNN □ | | 27pF | 50 | ±5% | 0.75 |
| 39 | CL21C300JBANNN □ | | 30pF | 50 | ±5% | 0.75 |
| 40 | CL21C330JBANNN □ | | 33pF | 50 | ±5% | 0.75 |
| 41 | CL21C360JBANNN □ | | 36pF | 50 | ±5% | 0.75 |
| 42 | CL21C390JBANNN □ | | 39pF | 50 | ±5% | 0.75 |
| 43 | CL21C430JBANNN □ | | 43pF | 50 | ±5% | 0.75 |
| 44 | CL21C470JBANNN □ | | 47pF | 50 | ±5% | 0.75 |
| 45 | CL21C510JBANNN □ | | 51pF | 50 | ±5% | 0.75 |

※ □ mark means packaging code. If you want to learn the code or quantity in detail, please see p80.

Product Lineup (General Capacitors-C0G)

| | Part Number | Size L×W (mm) | Capacitance | Rated Voltage (Vdc) | Capacitance Tolerance | Thickness Max. (mm) |
|----|------------------|---------------|-------------|---------------------|-----------------------|---------------------|
| 46 | CL21C560JBANNN □ | 2.00×1.25 | 56pF | 50 | ±5% | 0.75 |
| 47 | CL21C620JBANNN □ | | 62pF | 50 | ±5% | 0.75 |
| 48 | CL21C680JBANNN □ | | 68pF | 50 | ±5% | 0.75 |
| 49 | CL21C750JBANNN □ | | 75pF | 50 | ±5% | 0.75 |
| 50 | CL21C820JBANNN □ | | 82pF | 50 | ±5% | 0.75 |
| 51 | CL21C910JBANNN □ | | 91pF | 50 | ±5% | 0.75 |
| 52 | CL21C101JBANNN □ | | 100pF | 50 | ±5% | 0.75 |
| 53 | CL21C111JBANNN □ | | 110pF | 50 | ±5% | 0.75 |
| 54 | CL21C121JBANNN □ | | 120pF | 50 | ±5% | 0.75 |
| 55 | CL21C131JBANNN □ | | 130pF | 50 | ±5% | 0.75 |
| 56 | CL21C151JBANNN □ | | 150pF | 50 | ±5% | 0.75 |
| 57 | CL21C161JBANNN □ | | 160pF | 50 | ±5% | 0.75 |
| 58 | CL21C181JBANNN □ | | 180pF | 50 | ±5% | 0.75 |
| 59 | CL21C201JBANNN □ | | 200pF | 50 | ±5% | 0.75 |
| 60 | CL21C221JBANNN □ | | 220pF | 50 | ±5% | 0.75 |
| 61 | CL21C241JBANNN □ | | 240pF | 50 | ±5% | 0.75 |
| 62 | CL21C271JBANNN □ | | 270pF | 50 | ±5% | 0.75 |
| 63 | CL21C301JBANNN □ | | 300pF | 50 | ±5% | 0.75 |
| 64 | CL21C331JBANNN □ | | 330pF | 50 | ±5% | 0.75 |
| 65 | CL21C361JBANNN □ | | 360pF | 50 | ±5% | 0.75 |
| 66 | CL21C391JBANNN □ | | 390pF | 50 | ±5% | 0.75 |
| 67 | CL21C431JBANNN □ | | 430pF | 50 | ±5% | 0.75 |
| 68 | CL21C471JBANNN □ | | 470pF | 50 | ±5% | 0.75 |
| 69 | CL21C511JBANNN □ | | 510pF | 50 | ±5% | 0.75 |
| 70 | CL21C561JBANNN □ | | 560pF | 50 | ±5% | 0.75 |
| 71 | CL21C621JBCNNN □ | | 620pF | 50 | ±5% | 0.95 |
| 72 | CL21C681JBCNNN □ | | 680pF | 50 | ±5% | 0.95 |
| 73 | CL21C751JBCNNN □ | | 750pF | 50 | ±5% | 0.95 |
| 74 | CL21C821JBCNNN □ | | 820pF | 50 | ±5% | 0.95 |
| 75 | CL21C102JBCNNN □ | | 1nF | 50 | ±5% | 0.95 |
| 76 | CL21C122JBFNNN □ | | 1.2nF | 50 | ±5% | 1.35 |
| 77 | CL21C152JBFNNN □ | | 1.5nF | 50 | ±5% | 1.35 |
| 78 | CL21C182JBFNNN □ | | 1.8nF | 50 | ±5% | 1.35 |
| 79 | CL21C222JBFNNN □ | | 2.2nF | 50 | ±5% | 1.35 |
| 80 | CL21C332JAFNNN □ | | 3.3nF | 25 | ±5% | 1.35 |
| 81 | CL21C332JBFNNN □ | | 3.3nF | 50 | ±5% | 1.35 |
| 82 | CL21C392JAANNN □ | | 3.9nF | 25 | ±5% | 0.75 |
| 83 | CL21C392JBFNNN □ | | 3.9nF | 50 | ±5% | 1.35 |
| 84 | CL21C472JAFNNN □ | 4.7nF | 25 | ±5% | 1.35 | |
| 85 | CL21C472JBFNNN □ | 4.7nF | 50 | ±5% | 1.35 | |
| 86 | CL21C562JBFNNN □ | 5.6nF | 50 | ±5% | 1.35 | |
| 87 | CL21C822JAFNNN □ | 8.2nF | 25 | ±5% | 1.35 | |
| 88 | CL21C103JBFNNN □ | 10nF | 50 | ±5% | 1.35 | |
| 1 | CL31C0R5CBCNNN □ | 3.20×1.60 | 0.5pF | 50 | ±0.25pF | 1.0 |
| 2 | CL31C010CBCNNN □ | | 1.0pF | 50 | ±0.25pF | 1.0 |
| 3 | CL31C1R5CBCNNN □ | | 1.5pF | 50 | ±0.25pF | 1.0 |
| 4 | CL31C1R8CBCNNN □ | | 1.8pF | 50 | ±0.25pF | 1.0 |
| 5 | CL31C020CBCNNN □ | | 2.0pF | 50 | ±0.25pF | 1.0 |
| 6 | CL31C2R2CBCNNN □ | | 2.2pF | 50 | ±0.25pF | 1.0 |
| 7 | CL31C2R7CBCNNN □ | | 2.7pF | 50 | ±0.25pF | 1.0 |

※ □ mark means packaging code. If you want to learn the code or quantity in detail, please see p80.

- Part Numbering System
- General Capacitors
- High Capacitance Capacitors
- Super Small Size Capacitors
- Medium-High Voltage Capacitors
- Array Type Capacitors
- Low ESL Capacitors
- Reliability Test Condition
- Premium Capacitors for Automotive Applications
- Packaging Specification
- Application Manual for Surface Mounting



Product Lineup (General Capacitors-C0G)

| | Part Number | Size L×W (mm) | Capacitance | Rated Voltage (Vdc) | Capacitance Tolerance | Thickness Max. (mm) | |
|----|-------------------|---------------|-------------|---------------------|-----------------------|---------------------|------|
| 8 | CL31C030CBCN NN □ | 3.20×1.60 | 3.0pF | 50 | ±0.25pF | 1.0 | |
| 9 | CL31C3R3CBCN NN □ | | 3.3pF | 50 | ±0.25pF | 1.0 | |
| 10 | CL31C040CBCN NN □ | | 4.0pF | 50 | ±0.25pF | 1.0 | |
| 11 | CL31C4R7CBCN NN □ | | 4.7pF | 50 | ±0.25pF | 1.0 | |
| 12 | CL31C100JBCN NN □ | | 10pF | 50 | ±5% | 1.0 | |
| 13 | CL31C120JBCN NN □ | | 12pF | 50 | ±5% | 1.0 | |
| 14 | CL31C150JBCN NN □ | | 15pF | 50 | ±5% | 1.0 | |
| 15 | CL31C180JBCN NN □ | | 18pF | 50 | ±5% | 1.0 | |
| 16 | CL31C200JBCN NN □ | | 20pF | 50 | ±5% | 1.0 | |
| 17 | CL31C220JBCN NN □ | | 22pF | 50 | ±5% | 1.0 | |
| 18 | CL31C270JBCN NN □ | | 27pF | 50 | ±5% | 1.0 | |
| 19 | CL31C300JBCN NN □ | | 30pF | 50 | ±5% | 1.0 | |
| 20 | CL31C330JBCN NN □ | | 33pF | 50 | ±5% | 1.0 | |
| 21 | CL31C390JBCN NN □ | | 39pF | 50 | ±5% | 1.0 | |
| 22 | CL31C470JBCN NN □ | | 47pF | 50 | ±5% | 1.0 | |
| 23 | CL31C510JBCN NN □ | | 51pF | 50 | ±5% | 1.0 | |
| 24 | CL31C560JBCN NN □ | | 56pF | 50 | ±5% | 1.0 | |
| 25 | CL31C680JBCN NN □ | | 68pF | 50 | ±5% | 1.0 | |
| 26 | CL31C750JBCN NN □ | | 75pF | 50 | ±5% | 1.0 | |
| 27 | CL31C820JBCN NN □ | | 82pF | 50 | ±5% | 1.0 | |
| 28 | CL31C101JBCN NN □ | | 100pF | 50 | ±5% | 1.0 | |
| 29 | CL31C121JBCN NN □ | | 120pF | 50 | ±5% | 1.0 | |
| 30 | CL31C151JBCN NN □ | | 150pF | 50 | ±5% | 1.0 | |
| 31 | CL31C181JBCN NN □ | | 180pF | 50 | ±5% | 1.0 | |
| 32 | CL31C221JBCN NN □ | | 220pF | 50 | ±5% | 1.0 | |
| 33 | CL31C271JBCN NN □ | | 270pF | 50 | ±5% | 1.0 | |
| 34 | CL31C331JBCN NN □ | | 330pF | 50 | ±5% | 1.0 | |
| 35 | CL31C391JBCN NN □ | | 390pF | 50 | ±5% | 1.0 | |
| 36 | CL31C471JBCN NN □ | | 470pF | 50 | ±5% | 1.0 | |
| 37 | CL31C561JBCN NN □ | | 560pF | 50 | ±5% | 1.0 | |
| 38 | CL31C681JBCN NN □ | | 680pF | 50 | ±5% | 1.0 | |
| 39 | CL31C821JBCN NN □ | | 820pF | 50 | ±5% | 1.0 | |
| 40 | CL31C102JBCN NN □ | | 1nF | 50 | ±5% | 1.0 | |
| 41 | CL31C122JBCN NN □ | | 1.2nF | 50 | ±5% | 1.0 | |
| 42 | CL31C152JBCN NN □ | | 1.5nF | 50 | ±5% | 1.0 | |
| 43 | CL31C182JBCN NN □ | | 1.8nF | 50 | ±5% | 1.0 | |
| 44 | CL31C222JBCN NN □ | | 2.2nF | 50 | ±5% | 1.0 | |
| 45 | CL31C272JBFN NN □ | | 2.7nF | 50 | ±5% | 1.4 | |
| 46 | CL31C332JBFN NN □ | | 3.3nF | 50 | ±5% | 1.4 | |
| 47 | CL31C472JBFN NN □ | | 4.7nF | 50 | ±5% | 1.4 | |
| 48 | CL31C682JBHN NN □ | | 6.8nF | 50 | ±5% | 1.8 | |
| 49 | CL31C103JAFN NN □ | | 10nF | 25 | ±5% | 1.4 | |
| 50 | CL31C223JBHN NN □ | | 22nF | 50 | ±5% | 1.8 | |
| 51 | CL31C333JBHN NN □ | | 33nF | 50 | ±5% | 1.8 | |
| 1 | CL32C472JBFN NN □ | | 3.20×2.50 | 4.7nF | 50 | ±5% | 1.45 |
| 2 | CL32C103JBFN NN □ | | | 10nF | 50 | ±5% | 1.45 |
| 3 | CL32C223JBHN NN □ | | | 22nF | 50 | ±5% | 1.80 |

※ □ mark means packaging code. If you want to learn the code or quantity in detail, please see p80.

Product Lineup (General Capacitors-X7R)

| | Part Number | Size L×W (mm) | Capacitance | Rated Voltage (Vdc) | Capacitance Tolerance | Thickness Max. (mm) |
|----|------------------|---------------|-------------|---------------------|-----------------------|---------------------|
| 1 | CL05B471KB5NNN □ | 1.00×0.50 | 470pF | 50 | ±10% | 0.55 |
| 2 | CL05B221KB5NNN □ | | 220pF | 50 | ±10% | 0.55 |
| 3 | CL05B681KB5NNN □ | | 680pF | 50 | ±10% | 0.55 |
| 4 | CL05B102KB5NNN □ | | 1nF | 50 | ±10% | 0.55 |
| 5 | CL05B102KA5NNN □ | | 1nF | 25 | ±10% | 0.55 |
| 6 | CL05B222KB5NNN □ | | 2.2nF | 50 | ±10% | 0.55 |
| 7 | CL05B472KB5NNN □ | | 4.7nF | 50 | ±10% | 0.55 |
| 8 | CL05B472KA5NNN □ | | 4.7nF | 25 | ±10% | 0.55 |
| 9 | CL05B682KB5NNN □ | | 6.8nF | 50 | ±10% | 0.55 |
| 10 | CL05B682KA5NNN □ | | 6.8nF | 25 | ±10% | 0.55 |
| 11 | CL05B103KB5NNN □ | | 10nF | 50 | ±10% | 0.55 |
| 12 | CL05B103KA5NNN □ | | 10nF | 25 | ±10% | 0.55 |
| 13 | CL05B223KA5NNN □ | | 22nF | 25 | ±10% | 0.55 |
| 14 | CL05B473KO5NNN □ | | 47nF | 16 | ±10% | 0.55 |
| 15 | CL05B473KP5NNN □ | | 47nF | 10 | ±10% | 0.55 |
| 16 | CL05B683KO5NNN □ | | 68nF | 16 | ±10% | 0.55 |
| 17 | CL05B683KP5NNN □ | | 68nF | 10 | ±10% | 0.55 |
| 18 | CL05B104KO5NNN □ | | 100nF | 16 | ±10% | 0.55 |
| 19 | CL05B104KP5NNN □ | | 100nF | 10 | ±10% | 0.55 |
| 20 | CL05B104KQ5NNN □ | | 100nF | 6.3 | ±10% | 0.55 |
| 1 | CL10B101KB8NNN □ | 1.60×0.80 | 100pF | 50 | ±10% | 0.9 |
| 2 | CL10B221KB8NNN □ | | 220pF | 50 | ±10% | 0.9 |
| 3 | CL10B471KB8NNN □ | | 470pF | 50 | ±10% | 0.9 |
| 4 | CL10B681KB8NNN □ | | 680pF | 50 | ±10% | 0.9 |
| 5 | CL10B102KB8NNN □ | | 1nF | 50 | ±10% | 0.9 |
| 6 | CL10B102KA8NNN □ | | 1nF | 25 | ±10% | 0.9 |
| 7 | CL10B222KB8NNN □ | | 2.2nF | 50 | ±10% | 0.9 |
| 8 | CL10B472KB8NNN □ | | 4.7nF | 50 | ±10% | 0.9 |
| 9 | CL10B472KA8NNN □ | | 4.7nF | 25 | ±10% | 0.9 |
| 10 | CL10B682KB8NNN □ | | 6.8nF | 50 | ±10% | 0.9 |
| 11 | CL10B103KB8NNN □ | | 10nF | 50 | ±10% | 0.9 |
| 12 | CL10B103KA8NNN □ | | 10nF | 25 | ±10% | 0.9 |
| 13 | CL10B223KA8NNN □ | | 22nF | 25 | ±10% | 0.9 |
| 14 | CL10B473KB8NNN □ | | 47nF | 50 | ±10% | 0.9 |
| 15 | CL10B473KA8NNN □ | | 47nF | 25 | ±10% | 0.9 |
| 16 | CL10B683KB8NNN □ | | 68nF | 50 | ±10% | 0.9 |
| 17 | CL10B683KA8NNN □ | | 68nF | 25 | ±10% | 0.9 |
| 18 | CL10B104KB8NNN □ | | 100nF | 50 | ±10% | 0.9 |
| 19 | CL10B224KA8NNN □ | | 220nF | 25 | ±10% | 0.9 |
| 20 | CL10B224KO8NNN □ | | 220nF | 16 | ±10% | 0.9 |
| 21 | CL10B225KQ8NNN □ | | 2.2uF | 63 | ±10% | 0.9 |
| 1 | CL21B221KBANNN □ | 2.00×1.25 | 220pF | 50 | ±10% | 0.75 |
| 2 | CL21B471KBANNN □ | | 470pF | 50 | ±10% | 0.75 |
| 3 | CL21B681KBANNN □ | | 680pF | 50 | ±10% | 0.75 |
| 4 | CL21B102KBANNN □ | | 1nF | 50 | ±10% | 0.75 |
| 5 | CL21B102KBCNNN □ | | 1nF | 50 | ±10% | 0.95 |
| 6 | CL21B222KBANNN □ | | 2.2nF | 50 | ±10% | 0.75 |
| 7 | CL21B222KBCNNN □ | | 2.2nF | 50 | ±10% | 0.95 |
| 8 | CL21B682KBANNN □ | | 6.8nF | 50 | ±10% | 0.75 |
| 9 | CL21B103KBANNN □ | | 10nF | 50 | ±10% | 0.75 |

※ □ mark means packaging code. If you want to learn the code or quantity in detail, please see p80.

※ For parts of higher capacitance than those above listed, refer to the product lineup of 'High Cacaitance' subcategory.

- Part Numbering System
- General Capacitors
- High Capacitance Capacitors
- Super Small Size Capacitors
- Medium-High Voltage Capacitors
- Array Type Capacitors
- Low ESL Capacitors
- Reliability Test Condition
- Premium Capacitors for Automotive Applications
- Packaging Specification
- Application Manual for Surface Mounting



Product Lineup (General Capacitors-X7R)

| | Part Number | Size L×W (mm) | Capacitance | Rated Voltage (Vdc) | Capacitance Tolerance | Thickness Max. (mm) | |
|----|------------------|---------------|-------------|---------------------|-----------------------|---------------------|-----|
| 10 | CL21B103KBCNNN □ | 2.00×1.25 | 10nF | 50 | ±10% | 0.95 | |
| 11 | CL21B223KBANNN □ | | 22nF | 50 | ±10% | 0.75 | |
| 12 | CL21B223KBCNNN □ | | 22nF | 50 | ±10% | 0.95 | |
| 13 | CL21B473KBANNN □ | | 47nF | 50 | ±10% | 0.75 | |
| 14 | CL21B473KBCNNN □ | | 47nF | 50 | ±10% | 0.95 | |
| 15 | CL21B683KAANNN □ | | 68nF | 25 | ±10% | 0.75 | |
| 16 | CL21B683KBCNNN □ | | 68nF | 50 | ±10% | 0.95 | |
| 17 | CL21B683KBFNNN □ | | 68nF | 50 | ±10% | 1.35 | |
| 18 | CL21B104KBCNNN □ | | 100nF | 50 | ±10% | 0.95 | |
| 19 | CL21B104KBFNNN □ | | 100nF | 50 | ±10% | 1.35 | |
| 20 | CL21B224KBFNNN □ | | 220nF | 50 | ±10% | 1.35 | |
| 21 | CL21B224KAFNNN □ | | 220nF | 25 | ±10% | 1.35 | |
| 22 | CL21B224KOCNNN □ | | 220nF | 16 | ±10% | 0.95 | |
| 23 | CL21B224KOFNNN □ | | 220nF | 16 | ±10% | 1.35 | |
| 24 | CL21B474KBFNNN □ | | 470nF | 50 | ±10% | 1.35 | |
| 25 | CL21B474KAFNNN □ | | 470nF | 25 | ±10% | 1.35 | |
| 26 | CL21B474KOFNNN □ | | 470nF | 16 | ±10% | 1.35 | |
| 27 | CL21B684KOFNNN □ | | 680nF | 16 | ±10% | 1.35 | |
| 28 | CL21B684KPFNNN □ | | 680nF | 10 | ±10% | 1.35 | |
| 1 | CL31B221KBCNNN □ | | 3.20×1.60 | 220pF | 50 | ±10% | 1.0 |
| 2 | CL31B471KBCNNN □ | | | 470pF | 50 | ±10% | 1.0 |
| 3 | CL31B681KBCNNN □ | | | 680pF | 50 | ±10% | 1.0 |
| 4 | CL31B102KBCNNN □ | | | 1nF | 50 | ±10% | 1.0 |
| 5 | CL31B222KBCNNN □ | | | 2.2nF | 50 | ±10% | 1.0 |
| 6 | CL31B472KBCNNN □ | | | 4.7nF | 50 | ±10% | 1.0 |
| 7 | CL31B682KBCNNN □ | | | 6.8nF | 50 | ±10% | 1.0 |
| 8 | CL31B103KBCNNN □ | | | 10nF | 50 | ±10% | 1.0 |
| 9 | CL31B223KBCNNN □ | | | 22nF | 50 | ±10% | 1.0 |
| 10 | CL31B473KBCNNN □ | 47nF | | 50 | ±10% | 1.0 | |
| 11 | CL31B683KBCNNN □ | 68nF | | 50 | ±10% | 1.0 | |
| 12 | CL31B104KBCNNN □ | 100nF | | 50 | ±10% | 1.0 | |
| 13 | CL31B104KACNNN □ | 100nF | | 25 | ±10% | 1.0 | |
| 14 | CL31B224KBCNNN □ | 220nF | | 50 | ±10% | 1.0 | |
| 15 | CL31B224KAFNNN □ | 220nF | | 25 | ±10% | 1.4 | |
| 16 | CL31B474KBFNNN □ | 470nF | | 50 | ±10% | 1.4 | |
| 17 | CL31B474KAHNNN □ | 470nF | | 25 | ±10% | 1.8 | |
| 18 | CL31B474KOCNNN □ | 470nF | | 16 | ±10% | 1.0 | |
| 19 | CL31B684KBHNNN □ | 680nF | | 50 | ±10% | 1.8 | |
| 20 | CL31B684KAHNNN □ | 680nF | | 25 | ±10% | 1.8 | |
| 21 | CL31B105KBHNNN □ | 1μF | | 50 | ±10% | 1.8 | |
| 22 | CL31B105KAHNNN □ | 1μF | | 25 | ±10% | 1.8 | |
| 23 | CL31B105KOFNNN □ | 1μF | | 16 | ±10% | 1.4 | |
| 24 | CL31B225KBHNNN □ | 2.2μF | | 50 | ±10% | 1.8 | |
| 25 | CL31B225KAHNNN □ | 2.2μF | | 25 | ±10% | 1.8 | |
| 26 | CL31B225KOHNNN □ | 2.2μF | | 16 | ±10% | 1.8 | |
| 27 | CL31B225KPFNNN □ | 2.2μF | | 10 | ±10% | 1.4 | |
| 1 | CL32B104KBFNNN □ | 3.20×2.50 | 100nF | 50 | ±10% | 1.45 | |
| 2 | CL32B224KBFNNN □ | | 220nF | 50 | ±10% | 1.45 | |
| 3 | CL32B105KBFNNN □ | | 1μF | 50 | ±10% | 1.45 | |
| 4 | CL32B105KAHNNN □ | | 1μF | 25 | ±10% | 1.8 | |

※ □ mark means packaging code. If you want to learn the code or quantity in detail, please see p80.

※ For parts of higher capacitance than those above listed, refer to the product lineup of 'High Capacitance' subcategory.

Product Lineup (General Capacitors-X7R)

| | Part Number | Size L × W (mm) | Capacitance | Rated Voltage (Vdc) | Capacitance Tolerance | Thickness Max. (mm) |
|----|------------------|-----------------|-------------|---------------------|-----------------------|---------------------|
| 5 | CL32B104KBFNNN □ | 3.20×2.50 | 100nF | 50 | ±10% | 1.45 |
| 6 | CL32B224KBFNNN □ | | 220nF | 50 | ±10% | 1.45 |
| 7 | CL32B105KBFNNN □ | | 1μF | 50 | ±10% | 1.45 |
| 8 | CL32B105KAHNNN □ | | 1μF | 25 | ±10% | 1.8 |
| 9 | CL32B225KBINNN □ | | 2.2μF | 50 | ±10% | 2.2 |
| 10 | CL32B225KAJNNN □ | | 2.2μF | 25 | ±10% | 2.7 |
| 11 | CL32B474KBFNNN □ | | 470nF | 50 | ±10% | 1.45 |
| 12 | CL32B474KAFNNN □ | | 470nF | 25 | ±10% | 1.45 |
| 13 | CL32B475KOINNN □ | | 4.7μF | 16 | ±10% | 2.2 |
| 1 | CL43B224KBFNNN □ | | 4.50×3.20 | 220nF | 50 | ±10% |
| 2 | CL43B474KBFNNN □ | 470nF | | 50 | ±10% | 1.45 |
| 3 | CL43B684KBFNNN □ | 680nF | | 50 | ±10% | 1.45 |
| 4 | CL43B105KBFNNN □ | 1μF | | 50 | ±10% | 1.45 |
| 5 | CL43B106KALNNN □ | 10μF | | 25 | ±10% | 3.5 |
| 6 | CL43B226KPJNNN □ | 22μF | | 10 | ±10% | 2.7 |
| 1 | CL55B475KBJNNN □ | 5.70×5.00 | 4.7μF | 50 | ±10% | 2.7 |

Part Numbering System

General Capacitors

High Capacitance Capacitors

Super Small Size Capacitors

Medium-High Voltage Capacitors

Array Type Capacitors

Low ESL Capacitors

Reliability Test Condition

Premium Capacitors for Automotive Applications

Packaging Specification

Application Manual for Surface Mounting

Product Lineup (General Capacitors-X5R)

| | Part Number | Size L × W (mm) | Capacitance | Rated Voltage (Vdc) | Capacitance Tolerance | Thickness Max. (mm) |
|---|------------------|-----------------|-------------|---------------------|-----------------------|---------------------|
| 1 | CL05A223KO5NNN □ | 1.00×0.50 | 22nF | 16 | ±10% | 0.55 |
| 2 | CL05A104KA5NNN □ | | 100nF | 25 | ±10% | 0.55 |
| 3 | CL05A104KO5NNN □ | | 100nF | 16 | ±10% | 0.55 |
| 4 | CL05A104KP5NNN □ | | 100nF | 10 | ±10% | 0.55 |
| 5 | CL05A104KQ5NNN □ | | 100nF | 6.3 | ±10% | 0.55 |

※ □ mark means packaging code. If you want to learn the code or quantity in detail, please see p80.

※ For parts of higher capacitance than those above listed, refer to the product lineup of 'High Capacitance' subcategory.

Product Lineup (General Capacitors-Y5V)

| | Part Number | Size L×W (mm) | Capacitance | Rated Voltage (Vdc) | Capacitance Tolerance | Thickness Max. (mm) |
|----|------------------|------------------|-------------|---------------------------|--------------------------|------------------------|
| 1 | CL05F103ZB5NNN □ | 1.00×0.50 | 10nF | 50 | +80%~-20% | 0.55 |
| 2 | CL05F103ZO5NNN □ | | 10nF | 16 | +80%~-20% | 0.55 |
| 3 | CL05F223ZA5NNN □ | | 22nF | 25 | +80%~-20% | 0.55 |
| 4 | CL05F223ZO5NNN □ | | 22nF | 16 | +80%~-20% | 0.55 |
| 5 | CL05F473ZO5NNN □ | | 47nF | 16 | +80%~-20% | 0.55 |
| 6 | CL05F683ZO5NNN □ | | 68nF | 16 | +80%~-20% | 0.55 |
| 7 | CL05F104ZO5NNN □ | | 100nF | 16 | +80%~-20% | 0.55 |
| 1 | CL10F103ZB8NNN □ | 1.60×0.80 | 10nF | 50 | +80%~-20% | 0.9 |
| 2 | CL10F223ZB8NNN □ | | 22nF | 50 | +80%~-20% | 0.9 |
| 3 | CL10F473ZB8NNN □ | | 47nF | 50 | +80%~-20% | 0.9 |
| 4 | CL10F473ZA8NNN □ | | 47nF | 25 | +80%~-20% | 0.9 |
| 5 | CL10F473ZO8NNN □ | | 47nF | 16 | +80%~-20% | 0.9 |
| 6 | CL10F683ZB8NNN □ | | 68nF | 50 | +80%~-20% | 0.9 |
| 7 | CL10F104ZB8NNN □ | | 100nF | 50 | +80%~-20% | 0.9 |
| 8 | CL10F104ZA8NNN □ | | 100nF | 25 | +80%~-20% | 0.9 |
| 9 | CL10F224ZB8NNN □ | | 220nF | 50 | +80%~-20% | 0.9 |
| 10 | CL10F224ZA8NNN □ | | 220nF | 25 | +80%~-20% | 0.9 |
| 11 | CL10F225ZP8NNN □ | | 2.2μF | 10 | +80%~-20% | 0.9 |
| 12 | CL10F225ZQ8NNN □ | | 2.2μF | 6.3 | +80%~-20% | 0.9 |
| 1 | CL21F103ZBANNN □ | 2.00×1.25 | 10nF | 50 | +80%~-20% | 0.75 |
| 2 | CL21F223ZBANNN □ | | 22nF | 50 | +80%~-20% | 0.75 |
| 3 | CL21F473ZBANNN □ | | 47nF | 50 | +80%~-20% | 0.75 |
| 4 | CL21F683ZBANNN □ | | 68nF | 50 | +80%~-20% | 0.75 |
| 5 | CL21F104ZBANNN □ | | 100nF | 50 | +80%~-20% | 0.75 |
| 6 | CL21F104ZBCNNN □ | | 100nF | 50 | +80%~-20% | 0.95 |
| 7 | CL21F224ZBCNNN □ | | 220nF | 50 | +80%~-20% | 0.95 |
| 8 | CL21F224ZBFNNN □ | | 220nF | 50 | +80%~-20% | 1.35 |
| 9 | CL21F224ZOANNN □ | | 220nF | 16 | +80%~-20% | 0.75 |
| 10 | CL21F474ZACNNN □ | | 470nF | 25 | +80%~-20% | 0.95 |
| 11 | CL21F474ZBFNNN □ | | 470nF | 50 | +80%~-20% | 1.35 |
| 12 | CL21F474ZBFNNN □ | | 470nF | 50 | +80%~-20% | 1.35 |
| 13 | CL21F684ZAFNNN □ | | 680nF | 25 | +80%~-20% | 1.35 |
| 14 | CL21F684ZOANNN □ | | 680nF | 16 | +80%~-20% | 0.75 |
| 15 | CL21F225ZAFNNN □ | | 2.2μF | 25 | +80%~-20% | 1.35 |
| 16 | CL21F225ZOFNNN □ | | 2.2μF | 16 | +80%~-20% | 1.35 |
| 1 | CL31F103ZBCNNN □ | 3.20×1.60 | 10nF | 50 | +80%~-20% | 1.0 |
| 2 | CL31F104ZBCNNN □ | | 100nF | 50 | +80%~-20% | 1.0 |
| 3 | CL31F224ZBCNNN □ | | 220nF | 50 | +80%~-20% | 1.0 |
| 4 | CL31F474ZBCNNN □ | | 470nF | 50 | +80%~-20% | 1.0 |
| 5 | CL31F105ZBCNNN □ | | 1μF | 50 | +80%~-20% | 1.0 |
| 6 | CL31F105ZAFNNN □ | | 1μF | 25 | +80%~-20% | 1.4 |
| 7 | CL31F105ZOCNNN □ | | 1μF | 16 | +80%~-20% | 1.0 |
| 8 | CL31F225ZAFNNN □ | | 2.2μF | 25 | +80%~-20% | 1.4 |
| 9 | CL31F225ZOCNNN □ | | 2.2μF | 16 | +80%~-20% | 1.0 |
| 1 | CL32F475ZAHNNN □ | 3.20×2.50 | 4.7μF | 25 | +80%~-20% | 1.8 |
| 1 | CL43A476MQJNNN □ | 4.50×3.20 | 10μF | 6.3 | +80%~-20% | 2.7 |
| 2 | CL43A107MQLNNN □ | | 100μF | 6.3 | +80%~-20% | 3.5 |

※ □ mark means packaging code. If you want to learn the code or quantity in detail, please see p80.

※ For parts of higher capacitance than those above listed, refer to the product lineup of 'High Capacitance' subcategory.

High Capacitance Capacitors

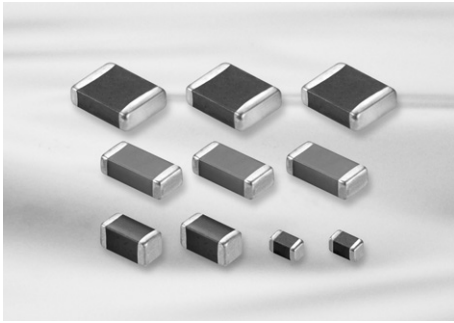

Feature

- Wide selection of size : from 0402 to 1812
- Highly reliable tolerance and high speed automatic chip placement on PCBs
- Wide capacitance range
- Highly reliable performance
- Highly resistant termination metal
- Tape & reel for surface mount assembly

Application

- Desktop PC, Note PC, HHP, DC-DC Converter, DSC
- LCD TV, LCD Monitor
- ※ For using special purpose like Military, Medical, Aviation, Automobile device should be following a special specification.

Structure and Dimensions

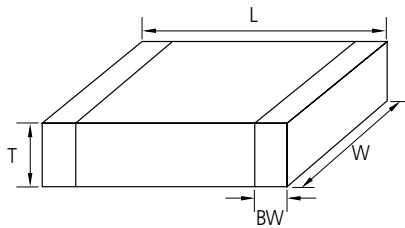

| Size Code | EIA Code | Dimension(mm) | | | | |
|-----------|----------|---------------|-----------|-----------|----------------|---------------|
| | | L | W | T | Thickness Code | BW |
| 05 | 0402 | 1.00±0.05 | 0.50±0.05 | 0.50±0.05 | 5 | 0.2+0.15/-0.1 |
| 10 | 0603 | 1.60±0.10 | 0.80±0.10 | 0.50±0.05 | 5 | 0.30±0.20 |
| | | | | 0.80±0.10 | 8 | |
| 21 | 0805 | 2.00±0.10 | 1.25±0.10 | 0.85±0.10 | C | 0.5+0.2/-0.3 |
| | | | | 1.25±0.10 | F | |
| | | | | 1.25±0.15 | Q | |
| 31 | 1206 | 3.20±0.20 | 1.60±0.20 | 1.25±0.15 | Y | 0.50±0.30 |
| | | | | 0.60±0.10 | 6 | |
| | | | | 0.85±0.10 | C | |
| | | | | 1.15±0.10 | P | |
| 32 | 1210 | 3.20±0.15 | 1.60±0.15 | 1.60±0.20 | H | 0.60±0.30 |
| | | | | 1.60±0.20 | H | |
| | | | | 0.85±0.10 | C | |
| | | | | 0.90±0.10 | 9 | |
| | | | | 1.80±0.20 | U | |
| | | | | 2.00±0.20 | I | |
| 42 | 1808 | 3.20±0.20 | 2.50±0.20 | 2.50±0.20 | J | 0.80±0.30 |
| | | | | 2.50±0.30 | v | |
| 43 | 1812 | 4.50±0.40 | 2.00±0.20 | 2.00±0.20 | I | 0.80±0.30 |
| | | 4.50±0.40 | 3.20±0.30 | 3.20±0.30 | L | 0.80±0.30 |

Part Numbering System

General Capacitors

High Capacitance Capacitors

Super Small Size Capacitors

Medium-High Voltage Capacitors

Array Type Capacitors

Low ESL Capacitors

Reliability Test Condition

Premium Capacitors for Automotive Applications

Packaging Specification

Application Manual for Surface Mounting

High Capacitance Table_Low Profile (X5R)

| Size(mm) | Tmax (mm) | Vr(V) | Capacitance (uF) | | | | | | | | |
|------------|--------------|-------|------------------|-----|-----|-----|-----|----|----|------------|--|
| | | | 1 | 2.2 | 4.7 | 10 | 22 | 33 | 47 | | |
| 0402(1005) | 0.3 | 6.3 | X6S | | | | | | | | |
| | | 10 | | | | | | | | | |
| | | 16 | | | | | | | | | |
| 0603(1608) | 0.5 | 6.3 | | | | | | | | | |
| | | 10 | | | | | | | | | |
| | | 16 | | | | | | | | | |
| | | 25 | | | | | | | | | |
| 0805(2012) | 0.7 | 10 | | | | | | | | | |
| | | 16 | | | | | | | | | |
| | | 25 | | | | | | | | | |
| | 0.95 | 4 | | | | | | | | (Tmax=1.0) | |
| | | 6.3 | | | | | | | | (Tmax=1.0) | |
| 10 | | | | | | | | | | | |
| 16 | | | | | | | | | | | |
| 25 | | | | | | | X6S | | | | |
| 1206(3216) | 0.7 | 10 | | | | | | | | | |
| | 0.95 | 6.3 | | | | | | | | | |
| | | 10 | | | | | | | | | |
| | | 16 | | | | | | | | | |
| | | 25 | | | | X6S | | | | | |
| | | 50 | | | | | | | | | |
| 1210(3225) | 0.95 | 16 | | | | | | | | | |
| | 2.0 | 25 | | | | | | | | | |
| | | 35 | | | | | | | | | |
| | | 50 | | | | | | | | | |

- Part Numbering System
- General Capacitors
- High Capacitance Capacitors
- Super Small Size Capacitors
- Medium-High Voltage Capacitors
- Array Type Capacitors
- Low ESL Capacitors
- Reliability Test Condition
- Premium Capacitors for Automotive Applications
- Packaging Specification
- Application Manual for Surface Mounting



High Capacitance Table (X6S)

| Size(mm) | Vr(V) | Capacitance (uF) | | | | | | | | | |
|------------|-------|------------------|------|------|---|-----|-----|----|----|----|-----|
| | | 0.1 | 0.22 | 0.47 | 1 | 2.2 | 4.7 | 10 | 22 | 47 | 100 |
| 0402(1005) | 4 | | ■ | ■ | ■ | ■ | ■ | ■ | ■ | ■ | ■ |
| | 6.3 | | ■ | ■ | ■ | ■ | ■ | ■ | ■ | ■ | ■ |
| | 10 | | ■ | ■ | ■ | ■ | ■ | ■ | ■ | ■ | ■ |
| 0603(1608) | 4 | | | ■ | ■ | ■ | ■ | ■ | ■ | ■ | ■ |
| | 6.3 | | | ■ | ■ | ■ | ■ | ■ | ■ | ■ | ■ |
| | 10 | | | ■ | ■ | ■ | ■ | ■ | ■ | ■ | ■ |
| | 16 | | | ■ | ■ | ■ | ■ | ■ | ■ | ■ | ■ |
| | 25 | | | ■ | ■ | ■ | ■ | ■ | ■ | ■ | ■ |
| 0805(2012) | 4 | | | | ■ | ■ | ■ | ■ | ■ | ■ | ■ |
| | 6.3 | | | | ■ | ■ | ■ | ■ | ■ | ■ | ■ |
| | 10 | | | | ■ | ■ | ■ | ■ | ■ | ■ | ■ |
| | 16 | | | | ■ | ■ | ■ | ■ | ■ | ■ | ■ |
| | 25 | | | | ■ | ■ | ■ | ■ | ■ | ■ | ■ |
| 1206(3216) | 6.3 | | | | | | ■ | ■ | ■ | ■ | ■ |
| | 10 | | | | | | ■ | ■ | ■ | ■ | ■ |
| | 16 | | | | | | ■ | ■ | ■ | ■ | ■ |
| | 25 | | | | | | ■ | ■ | ■ | ■ | ■ |
| 1210(3225) | 6.3 | | | | | | | ■ | ■ | ■ | ■ |
| | 10 | | | | | | | ■ | ■ | ■ | ■ |
| | 16 | | | | | | | ■ | ■ | ■ | ■ |
| | 25 | | | | | | | ■ | ■ | ■ | ■ |

High Capacitance Table (X7R)

| Size(mm) | Vr(V) | Capacitance (uF) | | | | | | | | | |
|------------|-------|------------------|------|------|---|-----|-----|----|----|-----|-----|
| | | 0.1 | 0.22 | 0.47 | 1 | 2.2 | 4.7 | 10 | 22 | 47 | 100 |
| 0402(1005) | 6.3 | | ■ | | | | | | | | |
| | 10 | | ■ | | | | | | | | |
| | 16 | | ■ | | | | | | | | |
| 0603(1608) | 6.3 | | | ■ | ■ | ■ | ■ | | | | |
| | 10 | | | ■ | ■ | ■ | ■ | | | | |
| | 16 | | | ■ | ■ | ■ | ■ | | | | |
| | 25 | | | ■ | ■ | ■ | ■ | | | | |
| 0805(2012) | 6.3 | | | | ■ | ■ | ■ | ■ | ■ | | |
| | 10 | | | | ■ | ■ | ■ | ■ | ■ | | |
| | 16 | | | | ■ | ■ | ■ | ■ | ■ | | |
| | 25 | | | | ■ | ■ | ■ | ■ | ■ | X7S | |
| | 35 | | | | ■ | ■ | ■ | ■ | ■ | | |
| | 50 | | | | ■ | ■ | ■ | ■ | ■ | | |
| 1206(3216) | 6.3 | | | | | | | ■ | ■ | ■ | |
| | 10 | | | | | | | ■ | ■ | ■ | |
| | 16 | | | | | | | ■ | ■ | ■ | |
| | 25 | | | | | | | ■ | ■ | ■ | |
| | 35 | | | | | | | ■ | ■ | ■ | |
| | 50 | | | | | | | ■ | ■ | ■ | |
| 1210(3225) | 6.3 | | | | | | | | ■ | ■ | ■ |
| | 10 | | | | | | | | ■ | ■ | ■ |
| | 16 | | | | | | | | ■ | ■ | ■ |
| | 25 | | | | | | | | ■ | ■ | ■ |
| | 50 | | | | | | | | ■ | ■ | ■ |

- Part Numbering System
- General Capacitors
- High Capacitance Capacitors**
- Super Small Size Capacitors
- Medium-High Voltage Capacitors
- Array Type Capacitors
- Low ESL Capacitors
- Reliability Test Condition
- Premium Capacitors for Automotive Applications
- Packaging Specification
- Application Manual for Surface Mounting

Product Lineup (High Capacitance-X5R)

| | Part Number | Size L×W (mm) | Capacitance | Rated Voltage (Vdc) | Capacitance Tolerance | Thickness Max. (mm) |
|----|------------------|---------------|-------------|---------------------|-----------------------|---------------------|
| 1 | CL05A224KQ5NNN □ | 100×0.50 | 0.22 μF | 6.3 | ±10% | 0.55 |
| 2 | CL05A224KR5NNN □ | | 0.22 μF | 4 | ±10% | 0.55 |
| 3 | CL05A224KA5NNN □ | | 0.22 μF | 25 | ±10% | 0.55 |
| 4 | CL05A224KO5NNN □ | | 0.22 μF | 16 | ±10% | 0.55 |
| 5 | CL05A224KP5NNN □ | | 0.22 μF | 10 | ±10% | 0.55 |
| 6 | CL05A334KA5NNN □ | | 0.33 μF | 25 | ±10% | 0.55 |
| 7 | CL05A334KQ5NNN □ | | 0.33 μF | 6.3 | ±10% | 0.55 |
| 8 | CL05A334KR5NNN □ | | 0.33 μF | 4 | ±10% | 0.55 |
| 9 | CL05A474KA5NNN □ | | 0.47 μF | 25 | ±10% | 0.55 |
| 10 | CL05A474KO5NNN □ | | 0.47 μF | 16 | ±10% | 0.55 |
| 11 | CL05A474KP5NNN □ | | 0.47 μF | 10 | ±10% | 0.55 |
| 12 | CL05A474KQ5NNN □ | | 0.47 μF | 6.3 | ±10% | 0.55 |
| 13 | CL05A474KR5NNN □ | | 0.47 μF | 4 | ±10% | 0.55 |
| 14 | CL05A105KA5NQN □ | | 1 μF | 25 | ±10% | 0.60 |
| 15 | CL05A105KO5NNN □ | | 1 μF | 16 | ±10% | 0.55 |
| 16 | CL05A105KO3LQN □ | | 1 μF | 16 | ±10% | 0.33 |
| 17 | CL05A105KP5NNN □ | | 1 μF | 10 | ±10% | 0.55 |
| 18 | CL05A105KP3LNN □ | | 1 μF | 10 | ±10% | 0.33 |
| 19 | CL05A105KQ5NNN □ | | 1 μF | 6.3 | ±10% | 0.55 |
| 20 | CL05A105KQ3LNN □ | | 1 μF | 6.3 | ±10% | 0.33 |
| 21 | CL05A105KR5NNN □ | | 1 μF | 4 | ±10% | 0.55 |
| 22 | CL05A105KR3LNN □ | | 1 μF | 4 | ±10% | 0.33 |
| 23 | CL05A225KO5NQN □ | | 2.2 μF | 16 | ±10% | 0.60 |
| 24 | CL05A225MP5NSN □ | | 2.2 μF | 10 | ±20% | 0.57 |
| 25 | CL05A225KP3LRN □ | | 2.2 μF | 10 | ±10% | 0.33 |
| 26 | CL05A225MQ5NNN □ | | 2.2 μF | 6.3 | ±20% | 0.55 |
| 27 | CL05A225KQ3LRN □ | | 2.2 μF | 6.3 | ±10% | 0.33 |
| 28 | CL05A225MR5NNN □ | | 2.2 μF | 4 | ±20% | 0.55 |
| 29 | CL05A225KR3LRN □ | | 2.2 μF | 4 | ±10% | 0.33 |
| 30 | CL05A475MP5NRN □ | | 4.7 μF | 10 | ±20% | 0.65 |
| 31 | CL05A475MQ5NRN □ | | 4.7 μF | 6.3 | ±20% | 0.65 |
| 32 | CL05A475MR5NRN □ | | 4.7 μF | 4 | ±20% | 0.65 |
| 33 | CL05A106MQ5NUN □ | | 10 μF | 6.3 | ±20% | 0.70 |
| 34 | CL05A106MR5NRN □ | | 10 μF | 4 | ±20% | 0.65 |
| 1 | CL10A474KB8NNN □ | 1.60×0.80 | 0.47 μF | 50 | ±10% | 0.90 |
| 2 | CL10A474KA8NNN □ | | 0.47 μF | 25 | ±10% | 0.90 |
| 3 | CL10A474KP8NNN □ | | 0.47 μF | 10 | ±10% | 0.90 |
| 4 | CL10A474KQ8NNN □ | | 0.47 μF | 6.3 | ±10% | 0.90 |
| 5 | CL10A474KR8NNN □ | | 0.47 μF | 4 | ±10% | 0.90 |
| 6 | CL10A105KB8NNN □ | | 1 μF | 50 | ±10% | 0.90 |
| 7 | CL10A105KA85NN □ | | 1 μF | 25 | ±10% | 0.55 |
| 8 | CL10A105KA8NNN □ | | 1 μF | 25 | ±10% | 0.90 |
| 9 | CL10A105KO8NNN □ | | 1 μF | 16 | ±10% | 0.90 |
| 10 | CL10A105KO5LNN □ | | 1 μF | 16 | ±10% | 0.55 |
| 11 | CL10A105KP8NNN □ | | 1 μF | 10 | ±10% | 0.90 |
| 12 | CL10A105KP5LNN □ | | 1 μF | 10 | ±10% | 0.55 |
| 13 | CL10A105KQ8NNN □ | | 1 μF | 6.3 | ±10% | 0.90 |
| 14 | CL10A105KQ5LNN □ | | 1 μF | 6.3 | ±10% | 0.55 |

※ □ mark means packaging code. If you want to learn the code or quantity in detail, please see p80.

- Part Numbering System
- General Capacitors
- High Capacitance Capacitors
- Super Small Size Capacitors
- Medium-High Voltage Capacitors
- Array Type Capacitors
- Low ESL Capacitors
- Reliability Test Condition
- Premium Capacitors for Automotive Applications
- Packaging Specification
- Application Manual for Surface Mounting



Product Lineup (High Capacitance-X5R)

| | Part Number | Size L×W (mm) | Capacitance | Rated Voltage (Vdc) | Capacitance Tolerance | Thickness Max. (mm) |
|----|----------------------------|---------------|-------------|---------------------|-----------------------|---------------------|
| 15 | CL10A105KR8N [□] | 1.60×0.80 | 1 μF | 4 | ±10% | 0.90 |
| 16 | CL10A105KR5L [□] | | 1 μF | 4 | ±10% | 0.55 |
| 17 | CL10A225KA8N [□] | | 2.2 μF | 25 | ±10% | 0.90 |
| 18 | CL10A105KA85N [□] | | 2.2 μF | 25 | ±10% | 0.55 |
| 19 | CL10A225KO8N [□] | | 2.2 μF | 16 | ±10% | 0.90 |
| 20 | CL10A225KO5L [□] | | 2.2 μF | 16 | ±10% | 0.55 |
| 21 | CL10A225KP8N [□] | | 2.2 μF | 10 | ±10% | 0.90 |
| 22 | CL10A225KP5L [□] | | 2.2 μF | 10 | ±10% | 0.55 |
| 23 | CL10A225KQ8N [□] | | 2.2 μF | 6.3 | ±10% | 0.90 |
| 24 | CL10A225KQ5L [□] | | 2.2 μF | 6.3 | ±10% | 0.55 |
| 25 | CL10A225KR8N [□] | | 2.2 μF | 4 | ±10% | 0.90 |
| 26 | CL10A225KR5L [□] | | 2.2 μF | 4 | ±10% | 0.55 |
| 27 | CL10A335KQ8N [□] | | 3.3 μF | 6.3 | ±10% | 0.90 |
| 28 | CL10A335KR8N [□] | | 3.3 μF | 4 | ±10% | 0.90 |
| 29 | CL10A475KA8N [□] | | 4.7 μF | 25 | ±10% | 0.95 |
| 30 | CL10A475KO8N [□] | | 4.7 μF | 16 | ±10% | 0.90 |
| 31 | CL10A475KP8N [□] | | 4.7 μF | 10 | ±10% | 0.90 |
| 32 | CL10A475KP5N [□] | | 4.7 μF | 10 | ±10% | 0.55 |
| 33 | CL10A475KQ5L [□] | | 4.7 μF | 6.3 | ±10% | 0.55 |
| 34 | CL10A475KQ8N [□] | | 4.7 μF | 6.3 | ±10% | 0.90 |
| 35 | CL10A475KR5L [□] | | 4.7 μF | 4 | ±10% | 0.55 |
| 36 | CL10A475KR8N [□] | | 4.7 μF | 4 | ±10% | 0.90 |
| 37 | CL10A106MO8N [□] | | 10 μF | 16 | ±20% | 0.95 |
| 38 | CL10A106MP8N [□] | | 10 μF | 10 | ±20% | 0.90 |
| 39 | CL10A106KQ8N [□] | | 10 μF | 6.3 | ±10% | 0.90 |
| 40 | CL10A106MQ5N [□] | | 10 μF | 6.3 | ±10% | 0.55 |
| 41 | CL10A106KR8N [□] | | 10 μF | 4 | ±10% | 0.90 |
| 42 | CL10A106MR5N [□] | | 10 μF | 4 | ±10% | 0.55 |
| 43 | CL10A226MQ8N [□] | | 22 μF | 6.3 | ±20% | 1.00 |
| 44 | CL10A226MR8N [□] | | 22 μF | 4 | ±20% | 1.00 |
| 1 | CL21A105KBQ [□] | 2.00×1.25 | 1 μF | 50 | ±10% | 1.40 |
| 2 | CL21A105KAF [□] | | 1 μF | 25 | ±10% | 1.35 |
| 3 | CL21A105KA6L [□] | | 1 μF | 25 | ±10% | 0.70 |
| 4 | CL21A105KOF [□] | | 1 μF | 16 | ±10% | 1.35 |
| 5 | CL21A105KO6L [□] | | 1 μF | 16 | ±10% | 0.70 |
| 6 | CL21A105KQF [□] | | 1 μF | 6.3 | ±10% | 1.35 |
| 7 | CL21A105KRF [□] | | 1 μF | 4 | ±10% | 1.35 |
| 8 | CL21A225KBQ [□] | | 2.2 μF | 50 | ±10% | 1.40 |
| 9 | CL21A225KAF [□] | | 2.2 μF | 25 | ±10% | 1.35 |
| 10 | CL21A225KO6L [□] | | 2.2 μF | 16 | ±10% | 0.70 |
| 11 | CL21A225KOF [□] | | 2.2 μF | 16 | ±10% | 1.35 |
| 12 | CL21A225KPF [□] | | 2.2 μF | 10 | ±10% | 1.35 |
| 13 | CL21A225KQF [□] | | 2.2 μF | 6.3 | ±10% | 1.35 |
| 14 | CL21A225KRF [□] | | 2.2 μF | 4 | ±10% | 1.35 |
| 15 | CL21A475KBQ [□] | | 4.7 μF | 50 | ±10% | 1.40 |
| 16 | CL21A475KAQ [□] | | 4.7 μF | 25 | ±10% | 1.40 |
| 17 | CL21A475KACL [□] | | 4.7 μF | 25 | ±10% | 0.95 |
| 18 | CL21A475KOF [□] | | 4.7 μF | 16 | ±10% | 1.35 |
| 19 | CL21A475KOCL [□] | | 4.7 μF | 16 | ±10% | 0.70 |
| 20 | CL21A475KPF [□] | | 4.7 μF | 10 | ±10% | 1.35 |

※ □ mark means packaging code. If you want to learn the code or quantity in detail, please see p 80.

Product Lineup (High Capacitance-X5R)

| | Part Number | Size L×W (mm) | Capacitance | Rated Voltage (Vdc) | Capacitance Tolerance | Thickness Max. (mm) |
|----|-------------------|---------------|-------------|---------------------|-----------------------|---------------------|
| 21 | CL21A475KPCLNN □ | 2.00×1.25 | 4.7 μF | 10 | ±10% | 0.95 |
| 22 | CL21A475KQFNND □ | | 4.7 μF | 6.3 | ±10% | 1.35 |
| 23 | CL21A475KQCLNN □ | | 4.7 μF | 6.3 | ±10% | 0.95 |
| 24 | CL21A475KRFNND □ | | 4.7 μF | 4 | ±10% | 1.35 |
| 25 | CL21A106KAYNND □ | | 10 μF | 25 | ±10% | 1.45 |
| 26 | CL21A106KACLRN □ | | 10 μF | 25 | ±10% | 0.95 |
| 27 | CL21A106KOFNND □ | | 10 μF | 16 | ±10% | 1.35 |
| 28 | CL21A106KOQND □ | | 10 μF | 16 | ±10% | 1.40 |
| 29 | CL21A106KOCLRND □ | | 10 μF | 16 | ±10% | 0.70 |
| 30 | CL21A106KPFNND □ | | 10 μF | 10 | ±10% | 1.35 |
| 31 | CL21A106KPCLQN □ | | 10 μF | 10 | ±20% | 0.95 |
| 32 | CL21A106KQFNND □ | | 10 μF | 6.3 | ±10% | 1.35 |
| 33 | CL21A106KQCLNN □ | | 10 μF | 6.3 | ±10% | 0.95 |
| 34 | CL21A475KRCLNN □ | | 4.7 μF | 4 | ±10% | 0.95 |
| 35 | CL21A106KRFNND □ | | 10 μF | 4 | ±10% | 1.35 |
| 36 | CL21A106KRCLNN □ | | 10 μF | 4 | ±10% | 0.95 |
| 37 | CL21A226MPQND □ | | 22 μF | 10 | ±20% | 1.40 |
| 38 | CL21A226MPCLRND □ | | 22 μF | 10 | ±20% | 0.95 |
| 39 | CL21A226MQQND □ | | 22 μF | 6.3 | ±20% | 1.40 |
| 40 | CL21A226MQCLRND □ | | 22 μF | 6.3 | ±20% | 0.95 |
| 41 | CL21A226MRQND □ | | 22 μF | 4 | ±20% | 1.40 |
| 42 | CL21A226MRCLRND □ | | 22 μF | 4 | ±20% | 0.95 |
| 43 | CL21A336MQELNN □ | | 33 μF | 6.3 | ±20% | 1.20 |
| 44 | CL21A336MQ9LNN □ | | 33 μF | 6.3 | ±20% | 1.00 |
| 45 | CL21A336MRELNN □ | | 33 μF | 4 | ±20% | 1.20 |
| 46 | CL21A336MR9LNN □ | | 33 μF | 4 | ±20% | 1.00 |
| 47 | CL21A476MQYND □ | | 47 μF | 6.3 | ±20% | 1.45 |
| 48 | CL21A476MRYND □ | | 47 μF | 4.0 | ±20% | 1.45 |
| 1 | CL31A475KBHND □ | 3.20×1.60 | 4.7 μF | 50 | ±10% | 1.80 |
| 2 | CL31A475KB9LND □ | | 4.7 μF | 50 | ±10% | 1.00 |
| 3 | CL31A475KAHND □ | | 4.7 μF | 25 | ±10% | 1.80 |
| 4 | CL31A475KACLND □ | | 4.7 μF | 25 | ±10% | 0.95 |
| 5 | CL31A475KOHND □ | | 4.7 μF | 16 | ±10% | 1.80 |
| 6 | CL31A475KOCLND □ | | 4.7 μF | 16 | ±10% | 0.95 |
| 7 | CL31A475KPHND □ | | 4.7 μF | 10 | ±10% | 1.80 |
| 8 | CL31A475KQHND □ | | 4.7 μF | 6.3 | ±10% | 1.80 |
| 9 | CL31A475KRHND □ | | 4.7 μF | 4 | ±10% | 1.80 |
| 10 | CL31A106KBHND □ | | 10 μF | 50 | ±10% | 1.80 |
| 11 | CL31A106KAHND □ | | 10 μF | 25 | ±10% | 1.80 |
| 12 | CL31A106KACLND □ | | 10 μF | 25 | ±10% | 0.95 |
| 13 | CL31A106KOHND □ | | 10 μF | 16 | ±10% | 1.80 |
| 14 | CL31A106KOCLND □ | | 10 μF | 16 | ±10% | 0.95 |
| 15 | CL31A106KPHND □ | | 10 μF | 10 | ±10% | 1.80 |
| 16 | CL31A106KPCLND □ | | 10 μF | 10 | ±10% | 0.95 |
| 17 | CL31A106KQHND □ | | 10 μF | 6.3 | ±10% | 1.80 |
| 18 | CL31A106KRHND □ | | 10 μF | 4 | ±10% | 1.80 |
| 19 | CL31A156KQHND □ | | 15 μF | 6.3 | ±10% | 1.80 |
| 20 | CL31A156KRHND □ | | 15 μF | 4 | ±10% | 1.80 |
| 21 | CL31A226KAHND □ | | 22 μF | 25 | ±10% | 1.80 |
| 22 | CL31A226KOHND □ | | 22 μF | 16 | ±10% | 1.80 |

Part Numbering System

General Capacitors

High Capacitance Capacitors

Super Small Size Capacitors

Medium-High Voltage Capacitors

Array Type Capacitors

Low ESL Capacitors

Reliability Test Condition

Premium Capacitors for Automotive Applications

Packaging Specification

Application Manual for Surface Mounting

※ □ mark means packaging code. If you want to learn the code or quantity in detail, please see p 80.



Product Lineup (High Capacitance-X5R)

| | Part Number | Size L×W (mm) | Capacitance | Rated Voltage (Vdc) | Capacitance Tolerance | Thickness Max. (mm) | |
|----|--------------------|---------------|-------------|---------------------|-----------------------|---------------------|------|
| 23 | CL31A226KOC LNN □ | 3.20×1.60 | 22μF | 16 | ±10% | 0.95 | |
| 24 | CL31A226KPH LNN □ | | 22μF | 10 | ±10% | 1.80 | |
| 25 | CL31A226KPCL LNN □ | | 22μF | 10 | ±10% | 0.95 | |
| 26 | CL31A226KQH LNN □ | | 22μF | 6.3 | ±10% | 1.80 | |
| 27 | CL31A226KRH LNN □ | | 22μF | 4.0 | ±10% | 1.80 | |
| 28 | CL31A476MQH LNN □ | | 47μF | 6.3 | ±20% | 1.80 | |
| 29 | CL31A476MRH LNN □ | | 47μF | 4.0 | ±20% | 1.80 | |
| 30 | CL31A107MQH LNN □ | | 100μF | 6.3 | ±20% | 1.80 | |
| 31 | CL31A107MRH LNN □ | | 100μF | 4.0 | ±20% | 1.80 | |
| 1 | CL32A106KQC LNN □ | | 3.20×2.50 | 10μF | 6.3 | ±10% | 0.95 |
| 2 | CL32A106KRCL LNN □ | | | 10μF | 4.0 | ±10% | 0.95 |
| 3 | CL32A106KBUL LNN □ | 10μF | | 50 | ±10% | 2.00 | |
| 4 | CL32A106KAJ LNN □ | 10μF | | 25 | ±10% | 2.70 | |
| 5 | CL32A106KAUL LNN □ | 10μF | | 25 | ±10% | 2.00 | |
| 6 | CL32A106KOJ LNN □ | 10μF | | 16 | ±10% | 2.70 | |
| 7 | CL32A106KPJ LNN □ | 10μF | | 10 | ±10% | 2.70 | |
| 8 | CL32A226KAJ LNN □ | 22μF | | 25 | ±10% | 2.70 | |
| 9 | CL32A226KOJ LNN □ | 22μF | | 16 | ±10% | 2.70 | |
| 10 | CL32A226KOC LNN □ | 22μF | | 16 | ±10% | 0.95 | |
| 11 | CL32A226KPJ LNN □ | 22μF | | 10 | ±10% | 2.70 | |
| 12 | CL32A226KQJ LNN □ | 22μF | | 6.3 | ±10% | 2.70 | |
| 13 | CL32A226MQCL LNN □ | 22μF | | 6.3 | ±20% | 0.95 | |
| 14 | CL32A226KRJ LNN □ | 22μF | | 4.0 | ±10% | 2.70 | |
| 15 | CL32A226MRCL LNN □ | 22μF | | 4.0 | ±20% | 0.95 | |
| 16 | CL32A476KPJ LNN □ | 47μF | | 10 | ±10% | 2.70 | |
| 17 | CL32A476MQJ LNN □ | 47μF | | 6.3 | ±20% | 2.70 | |
| 18 | CL32A476MRJ LNN □ | 47μF | | 4.0 | ±20% | 2.70 | |
| 19 | CL32A107MPV LNN □ | 100μF | | 10 | ±20% | 2.80 | |
| 20 | CL32A107MQV LNN □ | 100μF | | 6.3 | ±20% | 2.80 | |
| 21 | CL32A107MRV LNN □ | 100μF | | 4.0 | ±20% | 2.80 | |
| 1 | CL43A476MQJ LNN □ | 4.50×3.20 | 47μF | 6.3 | ±20% | 2.70 | |
| 2 | CL43A476MRJ LNN □ | | 47μF | 4.0 | ±20% | 2.70 | |
| 3 | CL43A107KQL LNN □ | | 100μF | 6.3 | ±20% | 3.50 | |
| 4 | CL43A107KRL LNN □ | | 100μF | 4.0 | ±20% | 3.50 | |

※ □ mark means packaging code. If you want to learn the code or quantity in detail, please see p 80.

Product Lineup (High Capacitance-X6S)

| | Part Number | Size L×W (mm) | Capacitance | Rated Voltage (Vdc) | Capacitance Tolerance | Thickness Max. (mm) |
|----|------------------|---------------|-------------|---------------------|-----------------------|---------------------|
| 1 | CL05X224KP5NNN □ | 1.00×0.50 | 0.22 μF | 10 | ±10% | 0.55 |
| 2 | CL05X224KQ5NNN □ | | 0.22 μF | 6.3 | ±10% | 0.55 |
| 3 | CL05X224KR5NNN □ | | 0.22 μF | 4 | ±10% | 0.55 |
| 4 | CL05X474KP5NNN □ | | 0.47 μF | 10 | ±10% | 0.55 |
| 5 | CL05X474KQ5NNN □ | | 0.47 μF | 6.3 | ±10% | 0.55 |
| 6 | CL05X474KR5NNN □ | | 0.47 μF | 4 | ±10% | 0.55 |
| 7 | CL05X105KP5NNN □ | | 1 μF | 10 | ±10% | 0.55 |
| 8 | CL05X105MQ3LNN □ | | 1 μF | 6.3 | ±20% | 0.33 |
| 9 | CL05X105KQ5NNN □ | | 1 μF | 6.3 | ±10% | 0.55 |
| 10 | CL05X105MR3LNN □ | | 1 μF | 4 | ±20% | 0.33 |
| 11 | CL05X105KR5NNN □ | | 1 μF | 4 | ±10% | 0.55 |
| 12 | CL05X225MQ5NSN □ | | 2.2 μF | 6.3 | ±20% | 0.57 |
| 13 | CL05X225MR5NSN □ | | 2.2 μF | 4 | ±20% | 0.57 |
| 1 | CL10X474KA8NNN □ | 1.60×0.80 | 0.47 μF | 25 | ±10% | 0.90 |
| 2 | CL10X474KO8NNN □ | | 0.47 μF | 16 | ±10% | 0.90 |
| 3 | CL10X474KP8NNN □ | | 0.47 μF | 10 | ±10% | 0.90 |
| 4 | CL10X474KQ8NNN □ | | 0.47 μF | 6.3 | ±10% | 0.90 |
| 5 | CL10X474KR8NNN □ | | 0.47 μF | 4 | ±10% | 0.90 |
| 6 | CL10X105KA8NNN □ | | 1 μF | 25 | ±10% | 0.90 |
| 7 | CL10X105KO8NNN □ | | 1 μF | 16 | ±10% | 0.90 |
| 8 | CL10X105KP8NNN □ | | 1 μF | 10 | ±10% | 0.90 |
| 9 | CL10X105KQ8NNN □ | | 1 μF | 6.3 | ±10% | 0.90 |
| 10 | CL10X105KR8NNN □ | | 1 μF | 4 | ±10% | 0.90 |
| 11 | CL10X225KA8NQN □ | | 2.2 μF | 25 | ±10% | 0.90 |
| 12 | CL10X225KO8NNN □ | | 2.2 μF | 16 | ±10% | 0.90 |
| 13 | CL10X225KP8NNN □ | | 2.2 μF | 10 | ±10% | 0.90 |
| 14 | CL10X225KQ8NNN □ | | 2.2 μF | 6.3 | ±10% | 0.90 |
| 15 | CL10X225KR8NNN □ | | 2.2 μF | 4 | ±10% | 0.90 |
| 16 | CL10X475KA8NQN □ | | 4.7 μF | 25 | ±10% | 0.90 |
| 17 | CL10X475KO8NQN □ | | 4.7 μF | 16 | ±10% | 0.90 |
| 18 | CL10X475KP5NNN □ | | 4.7 μF | 10 | ±10% | 0.90 |
| 19 | CL10X475KQ8NNN □ | | 4.7 μF | 6.3 | ±10% | 0.90 |
| 20 | CL10X475KR8NNN □ | | 4.7 μF | 4 | ±10% | 0.90 |
| 21 | CL10X106MP8NNN □ | | 10 μF | 10 | ±20% | 0.90 |
| 22 | CL10X106KQ8NNN □ | | 10 μF | 6.3 | ±10% | 0.90 |
| 23 | CL10X106KR8NNN □ | | 10 μF | 4 | ±10% | 0.90 |
| 1 | CL21X105KAFNNN □ | 2.00×1.25 | 1 μF | 25 | ±10% | 1.35 |
| 2 | CL21X105KOFNNN □ | | 1 μF | 16 | ±10% | 1.35 |
| 3 | CL21X105KPFNNN □ | | 1 μF | 10 | ±10% | 1.35 |
| 4 | CL21X105KQFNNN □ | | 1 μF | 6.3 | ±10% | 1.35 |
| 5 | CL21X105KRFNNN □ | | 1 μF | 4 | ±10% | 1.35 |
| 6 | CL21X225KAFNNN □ | | 2.2 μF | 25 | ±10% | 1.35 |
| 7 | CL21X225KOFNNN □ | | 2.2 μF | 16 | ±10% | 1.35 |
| 8 | CL21X225KPFNNN □ | | 2.2 μF | 10 | ±10% | 1.35 |
| 9 | CL21X225KQFNNN □ | | 2.2 μF | 6.3 | ±10% | 1.35 |
| 10 | CL21X225KRFNNN □ | | 2.2 μF | 4 | ±10% | 1.35 |
| 11 | CL21X475KAQNNN □ | | 4.7 μF | 25 | ±10% | 1.40 |
| 12 | CL21X475KOFNNN □ | | 4.7 μF | 16 | ±10% | 1.35 |
| 13 | CL21X475KPFNNN □ | | 4.7 μF | 10 | ±10% | 1.35 |
| 14 | CL21X475KQFNNN □ | | 4.7 μF | 6.3 | ±10% | 1.35 |

※ □ mark means packaging code. If you want to learn the code or quantity in detail, please see p 80.

- Part Numbering System
- General Capacitors
- High Capacitance Capacitors
- Super Small Size Capacitors
- Medium-High Voltage Capacitors
- Array Type Capacitors
- Low ESL Capacitors
- Reliability Test Condition
- Premium Capacitors for Automotive Applications
- Packaging Specification
- Application Manual for Surface Mounting

Product Lineup (High Capacitance -X7R)

| | Part Number | Size L×W (mm) | Capacitance | Rated Voltage (Vdc) | Capacitance Tolerance | Thickness Max. (mm) | |
|----|------------------|---------------|-------------|---------------------|-----------------------|---------------------|------|
| 15 | CL21X475KRFNNN □ | 2.00×1.25 | 4.7μF | 4 | ±10% | 1.35 | |
| 16 | CL21X106KACLRN □ | | 10μF | 25 | ±10% | 0.95 | |
| 17 | CL21X106KAYNNN □ | | 10μF | 25 | ±10% | 1.45 | |
| 18 | CL21X106KOYNNN □ | | 10μF | 16 | ±10% | 1.45 | |
| 19 | CL21X106KPCLNN □ | | 10μF | 10 | ±10% | 0.95 | |
| 20 | CL21X106KPYNNN □ | | 10μF | 10 | ±10% | 1.45 | |
| 21 | CL21X106KQQNNN □ | | 10μF | 6.3 | ±10% | 1.40 | |
| 22 | CL21X106KRQNNN □ | | 10μF | 4 | ±10% | 1.40 | |
| 23 | CL21X106KRCLNN □ | | 10μF | 4 | ±10% | 0.95 | |
| 24 | CL21X226MQQNNN □ | | 22μF | 6.3 | ±20% | 1.40 | |
| 25 | CL21X226MRQNNN □ | | 22μF | 4 | ±20% | 1.40 | |
| 26 | CL21X476MRYNNN □ | | 47μF | 4 | ±20% | 1.45 | |
| 1 | CL31X475KAHNNN □ | | 3.20×1.60 | 4.7μF | 25 | ±10% | 1.80 |
| 2 | CL31X475KACLNN □ | | | 4.7μF | 25 | ±10% | 0.95 |
| 3 | CL31X475KOHNNN □ | 4.7μF | | 16 | ±10% | 1.80 | |
| 4 | CL31X475KPHNNN □ | 4.7μF | | 10 | ±10% | 1.80 | |
| 5 | CL31X475MQHNNN □ | 4.7μF | | 6.3 | ±20% | 1.80 | |
| 6 | CL31X475KRHNNN □ | 4.7μF | | 4 | ±10% | 1.80 | |
| 7 | CL31X106KACLNN □ | 10μF | | 25 | ±10% | 0.95 | |
| 8 | CL31X106KAHNNN □ | 10μF | | 25 | ±10% | 1.80 | |
| 9 | CL31X106KOHNNN □ | 10μF | | 16 | ±10% | 1.80 | |
| 10 | CL31X106KPHNNN □ | 10μF | | 10 | ±10% | 1.80 | |
| 11 | CL31X106KHNNN □ | 10μF | | 6.3 | ±10% | 1.80 | |
| 12 | CL31X106KRHNNN □ | 10μF | | 4 | ±10% | 1.80 | |
| 13 | CL31X226KOHNNN □ | 22μF | | 16 | ±10% | 1.80 | |
| 14 | CL31X226KPHNNN □ | 22μF | | 10 | ±10% | 1.80 | |
| 15 | CL31X226KHNNN □ | 22μF | | 6.3 | ±10% | 1.80 | |
| 16 | CL31X226KRHNNN □ | 22μF | | 4 | ±10% | 1.80 | |
| 17 | CL31X107MQHNNN □ | 100μF | | 6.3 | ±20% | 1.80 | |
| 18 | CL31X107MRHNNN □ | 100μF | | 4 | ±20% | 1.80 | |
| 1 | CL32X106KAUNNN □ | 3.20×2.50 | 10μF | 25 | ±10% | 2.00 | |
| 2 | CL32X106KOJNNN □ | | 10μF | 16 | ±10% | 2.70 | |
| 3 | CL32X106KPJNNN □ | | 10μF | 10 | ±10% | 2.70 | |
| 4 | CL32X106KQJNNN □ | | 10μF | 6.3 | ±10% | 2.70 | |
| 5 | CL32X106KRJNNN □ | | 10μF | 4 | ±10% | 2.70 | |
| 6 | CL32X226KAJNNN □ | | 22μF | 25 | ±10% | 2.70 | |
| 7 | CL32X226KOJNNN □ | | 22μF | 16 | ±10% | 2.70 | |
| 8 | CL32X226KPJNNN □ | | 22μF | 10 | ±10% | 2.70 | |
| 9 | CL32X226KQJNNN □ | | 22μF | 6.3 | ±10% | 2.70 | |
| 10 | CL32X226KRJNNN □ | | 22μF | 4 | ±10% | 2.70 | |
| 11 | CL32X476MPJNNN □ | | 47μF | 10 | ±20% | 2.70 | |
| 12 | CL32X476KQJNNN □ | | 47μF | 6.3 | ±10% | 2.70 | |
| 13 | CL32X476KRJNNN □ | | 47μF | 4 | ±10% | 2.70 | |
| 14 | CL32X107MQVNNN □ | | 100μF | 6.3 | ±20% | 2.70 | |
| 15 | CL32X107MRVNNN □ | | 100μF | 4 | ±20% | 2.70 | |

※ □ mark means packaging code. If you want to learn the code or quantity in detail, please see p80.

Product Lineup (High Capacitance -X7R)

| | Part Number | Size L×W (mm) | Capacitance | Rated Voltage (Vdc) | Capacitance Tolerance | Thickness Max. (mm) |
|----|------------------|---------------|-------------|---------------------|-----------------------|---------------------|
| 1 | CL05B224KO5NNN □ | 1.00×0.50 | 0.22 μF | 16 | ±10% | 0.55 |
| 2 | CL05B224KP5NNN □ | | 0.22 μF | 10 | ±10% | 0.55 |
| 3 | CL05B224KQ5NNN □ | | 0.22 μF | 6.3 | ±10% | 0.55 |
| 1 | CL10B474KA8NNN □ | 1.60×0.80 | 0.47 μF | 25 | ±10% | 0.90 |
| 2 | CL10B474KO8NNN □ | | 0.47 μF | 16 | ±10% | 0.90 |
| 3 | CL10B474KP8NNN □ | | 0.47 μF | 10 | ±10% | 0.90 |
| 4 | CL10B474KQ8NNN □ | | 0.47 μF | 6.3 | ±10% | 0.90 |
| 5 | CL10B105KA8NNN □ | | 1 μF | 25 | ±10% | 0.90 |
| 6 | CL10B105KO8NNN □ | | 1 μF | 16 | ±10% | 0.90 |
| 7 | CL10B105KP8NNN □ | | 1 μF | 10 | ±10% | 0.90 |
| 8 | CL10B105KQ8NNN □ | | 1 μF | 6.3 | ±10% | 0.90 |
| 9 | CL10B225KP8NNN □ | | 2.2 μF | 10 | ±10% | 0.90 |
| 10 | CL10B225KQ8NNN □ | | 2.2 μF | 6.3 | ±10% | 0.90 |
| 1 | CL21B105KBFNNN □ | 2.00×1.25 | 1 μF | 50 | ±10% | 1.35 |
| 2 | CL21B105KLFNNN □ | | 1 μF | 35 | ±10% | 1.35 |
| 3 | CL21B105KAFNNN □ | | 1 μF | 25 | ±10% | 1.35 |
| 4 | CL21B105KOFNNN □ | | 1 μF | 16 | ±10% | 1.35 |
| 5 | CL21B105KPFNNN □ | | 1 μF | 10 | ±10% | 1.35 |
| 6 | CL21B105KQFNNN □ | | 1 μF | 6.3 | ±10% | 1.35 |
| 7 | CL21B225KAFNNN □ | | 2.2 μF | 25 | ±10% | 1.35 |
| 8 | CL21B225KOFNNN □ | | 2.2 μF | 16 | ±10% | 1.35 |
| 9 | CL21B225KPFNNN □ | | 2.2 μF | 10 | ±10% | 1.35 |
| 10 | CL21B225KQFNNN □ | | 2.2 μF | 6.3 | ±10% | 1.35 |
| 11 | CL21B475KOFNFN □ | | 4.7 μF | 16 | ±10% | 1.35 |
| 12 | CL21B475KPFNNN □ | | 4.7 μF | 10 | ±10% | 1.35 |
| 13 | CL21B475KQQNNN □ | | 4.7 μF | 6.3 | ±10% | 1.35 |
| 14 | CL21B106KOQNNN □ | | 10 μF | 16 | ±10% | 1.40 |
| 15 | CL21B106KPQNNN □ | | 10 μF | 10 | ±10% | 1.35 |
| 16 | CL21B106KQQNNN □ | | 10 μF | 6.3 | ±10% | 1.35 |
| 1 | CL31B475KBHNNN □ | 3.20×1.60 | 4.7 μF | 50 | ±10% | 1.80 |
| 2 | CL31B475KLHNNN □ | | 4.7 μF | 35 | ±10% | 1.80 |
| 3 | CL31B475KAHNNN □ | | 4.7 μF | 25 | ±10% | 1.80 |
| 4 | CL31B475KOHNNN □ | | 4.7 μF | 16 | ±10% | 1.80 |
| 5 | CL31B475KPHNNN □ | | 4.7 μF | 10 | ±10% | 1.80 |
| 6 | CL31B475KQHNNN □ | | 4.7 μF | 6.3 | ±10% | 1.80 |
| 7 | CL31B106KLHNNN □ | | 10 μF | 35 | ±10% | 1.80 |
| 8 | CL31B106KAHNNN □ | | 10 μF | 25 | ±10% | 1.80 |
| 9 | CL31B106KOHNNN □ | | 10 μF | 16 | ±10% | 1.80 |
| 10 | CL31B106KPHNNN □ | | 10 μF | 10 | ±10% | 1.80 |
| 11 | CL31B106KQHNNN □ | | 10 μF | 6.3 | ±10% | 1.80 |
| 1 | CL32B106KBJNNN □ | 3.20×2.50 | 10 μF | 50 | ±10% | 2.70 |
| 2 | CL32B106KAJNNN □ | | 10 μF | 25 | ±10% | 2.70 |
| 3 | CL32B106KOJNNN □ | | 10 μF | 16 | ±10% | 2.70 |
| 4 | CL32B106KPINNN □ | | 10 μF | 10 | ±10% | 2.70 |
| 5 | CL32B106KQJNNN □ | | 10 μF | 6.3 | ±10% | 2.70 |
| 6 | CL32B226KAJNNN □ | | 22 μF | 25 | ±10% | 2.70 |
| 7 | CL32B226KOJNNN □ | | 22 μF | 16 | ±10% | 2.70 |
| 8 | CL32B226KPJNNN □ | | 22 μF | 10 | ±10% | 2.70 |
| 9 | CL32B226KQJNNN □ | | 22 μF | 6.3 | ±10% | 2.70 |
| 10 | CL32B476MQJNNN □ | | 47 μF | 6.3 | ±20% | 2.70 |

※ □ mark means packaging code. If you want to learn the code or quantity in detail, please see p80.

- Part Numbering System
- General Capacitors
- High Capacitance Capacitors
- Super Small Size Capacitors
- Medium-High Voltage Capacitors
- Array Type Capacitors
- Low ESL Capacitors
- Reliability Test Condition
- Premium Capacitors for Automotive Applications
- Packaging Specification
- Application Manual for Surface Mounting

Product Lineup (High Capacitance -Y5V)

| | Part Number | Size L×W (mm) | Capacitance | Rated Voltage (Vdc) | Capacitance Tolerance | Thickness Max. (mm) | |
|---|------------------|------------------|-------------|---------------------------|--------------------------|------------------------|------|
| 1 | CL05F224ZO5NNN □ | 1.00×0.50 | 0.22μF | 16 | 80%/-20% | 0.55 | |
| 2 | CL05F224ZP5NNN □ | | 0.22μF | 10 | 80%/-20% | 0.55 | |
| 3 | CL05F224ZQ5NNN □ | | 0.22μF | 6.3 | 80%/-20% | 0.55 | |
| 4 | CL05F474ZP5NNN □ | | 0.47μF | 10 | 80%/-20% | 0.55 | |
| 5 | CL05F474ZQ5NNN □ | | 0.47μF | 6.3 | 80%/-20% | 0.55 | |
| 6 | CL05F105ZQ5NNN □ | | 1μF | 6.3 | 80%/-20% | 0.55 | |
| 1 | CL10F474ZB8NNN □ | 1.60×0.80 | 0.47μF | 50 | 80%/-20% | 0.90 | |
| 2 | CL10F474ZA8NNN □ | | 0.47μF | 25 | 80%/-20% | 0.90 | |
| 3 | CL10F474ZO8NNN □ | | 0.47μF | 16 | 80%/-20% | 0.90 | |
| 4 | CL10F474ZP8NNN □ | | 0.47μF | 10 | 80%/-20% | 0.90 | |
| 5 | CL10F105ZO8NNN □ | | 1μF | 16 | 80%/-20% | 0.90 | |
| 6 | CL10F105ZP8NNN □ | | 1μF | 10 | 80%/-20% | 0.90 | |
| 7 | CL10F225ZP8NNN □ | | 2.2μF | 10 | 80%/-20% | 0.90 | |
| 8 | CL10F225ZQ8NNN □ | | 2.2μF | 6.3 | 80%/-20% | 0.90 | |
| 9 | CL10F475ZQ8NNN □ | | 4.7μF | 6.3 | 80%/-20% | 0.90 | |
| 1 | CL21F105ZBFNNN □ | 2.00×1.25 | 1μF | 50 | 80%/-20% | 1.35 | |
| 2 | CL21F105ZAFNNN □ | | 1μF | 25 | 80%/-20% | 1.35 | |
| 3 | CL21F105ZOFNNN □ | | 1μF | 16 | 80%/-20% | 1.35 | |
| 4 | CL21F225ZAFNNN □ | | 2.2μF | 25 | 80%/-20% | 1.35 | |
| 5 | CL21F225ZOFNNN □ | | 2.2μF | 16 | 80%/-20% | 1.35 | |
| 6 | CL21F475ZQFNNN □ | | 4.7μF | 6.3 | 80%/-20% | 1.35 | |
| 1 | CL21F475ZOFNNN □ | | 4.7μF | 16 | 80%/-20% | 1.35 | |
| 2 | CL21F475ZPFNNN □ | | 4.7μF | 10 | 80%/-20% | 1.35 | |
| 3 | CL21F106ZPFNNN □ | | 10μF | 10 | 80%/-20% | 1.35 | |
| 4 | CL21F106ZPCLNN □ | | 10μF | 10 | 80%/-20% | 0.95 | |
| 5 | CL21F106ZQFNNN □ | | 10μF | 6.3 | 80%/-20% | 1.35 | |
| 6 | CL21F106ZQCLNN □ | | 10μF | 6.3 | 80%/-20% | 0.95 | |
| 1 | CL31F475ZOHNNN □ | | 3.20×1.60 | 4.7μF | 16 | 80%/-20% | 1.80 |
| 2 | CL31F475ZPHNNN □ | | | 4.7μF | 10 | 80%/-20% | 1.80 |
| 3 | CL31F475ZQHNNN □ | 4.7μF | | 6.3 | 80%/-20% | 1.80 | |
| 4 | CL31F106ZOHNNN □ | 10μF | | 16 | 80%/-20% | 1.80 | |
| 5 | CL31F106ZPHNNN □ | 10μF | | 10 | 80%/-20% | 1.80 | |
| 6 | CL31F106ZQHNNN □ | 10μF | | 6.3 | 80%/-20% | 1.80 | |
| 7 | CL31F226ZPHNNN □ | 22μF | | 10 | 80%/-20% | 1.80 | |
| 8 | CL31F226ZQHNNN □ | 22μF | | 6.3 | 80%/-20% | 1.80 | |
| 1 | CL32F106ZAHLNN □ | 3.20×2.50 | 10μF | 25 | 80%/-20% | 1.80 | |
| 2 | CL32F106ZOELNN □ | | 10μF | 16 | 80%/-20% | 2.00 | |
| 3 | CL32F226ZPJNNN □ | | 22μF | 10 | 80%/-20% | 2.70 | |
| 4 | CL32F226ZPULNN □ | | 22μF | 10 | 80%/-20% | 2.00 | |
| 5 | CL32F476ZQJNNN □ | | 47μF | 6.3 | 80%/-20% | 2.70 | |
| 6 | CL32F107ZQJNNN □ | | 100μF | 6.3 | 80%/-20% | 2.70 | |

※ □ mark means packaging code. If you want to learn the code or quantity in detail, please see p80.

Super Small Size Capacitors

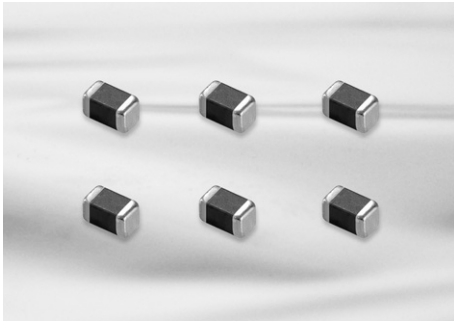

Feature

- Small chip size
- 03 Series(COG) MLCC shows very low ESR value.
- 02 and 03 Series are suited to only reflow soldering
- 02 and 03 Series are suited to miniature RF module, portable equipment and high frequency circuit

Application

- VCO, Tuner, RF Module
- MCM Module
- Mobile phone, Wireless LAN, Note PC
 - ※ For using special purpose like Military, Medical, Aviation, Automobile device should be following a special specification.

Structure and Dimensions

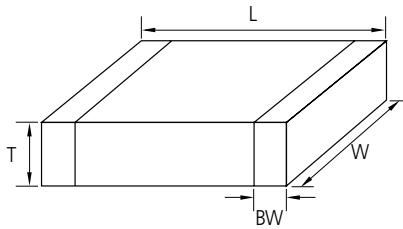

| Code | EIA Code | Dimension(mm) | | | |
|------|----------|---------------|----------|----------|-----------|
| | | L | W | T | BW |
| 02 | 01005 | 0.4±0.02 | 0.2±0.02 | 0.2±0.02 | 0.07~0.14 |
| 03 | 0201 | 0.6±0.03 | 0.3±0.03 | 0.3±0.03 | 0.15±0.05 |

Part Numbering System

General Capacitors

High Capacitance Capacitors

Super Small Size Capacitors

Medium-High Voltage Capacitors

Array Type Capacitors

Low ESL Capacitors

Reliability Test Condition

Premium Capacitors for Automotive Applications

Packaging Specification

Application Manual for Surface Mounting



Super Small Size Capacitance Table (C0G)

| Size(mm) | Tmax (mm) | Vr(V) | Capacitance (pF) | | | | | | | | | |
|----------|--------------|-------|------------------|---|----|----|----|-----|-----|-----|--|------|
| | | | 0.5 | 1 | 10 | 22 | 47 | 100 | 220 | 330 | | |
| C0G | 01005(0402) | 6.3 | | | | | | | | | | |
| | | 16 | | | | | | | | | | |
| | 0201(0603) | 25 | | | | | | | | | | |
| | | 50 | | | | | | | | | | 20pF |

Super Small Size Capacitance Table (X5R, X7R, Y5V)

| TC | Size (mm) | Vr(V) | Capacitance (uF) | | | | | | | | |
|-----|--------------|-------|------------------|------|------|---|-----|-----|----|----|--|
| | | | 0.1 | 0.22 | 0.47 | 1 | 2.2 | 4.7 | 10 | 22 | |
| X5R | 01005(0402) | 6.3 | | | | | | | | | |
| | | 4 | X5R or X6S | | | | | | | | |
| | 0201(0603) | 6.3 | | | | | | | | | |
| | | 10 | | | | | | | | | |
| | | 16 | | | | | | | | | |
| | | 25 | | | | | | | | | |
| X7R | 01005(0402) | 10 | | | | | | | | | |
| | 0201(0603) | 10 | | | | | | | | | |
| | | 16 | | | | | | | | | |
| Y5V | 0201(0603) | 6.3 | | | | | | | | | |

Product Lineup (Super Small Size Capacitors -C0G)

| | Part Number | Size L×W (mm) | Capacitance | Rated Voltage (Vdc) | Capacitance Tolerance | Thickness Max. (mm) | |
|----|------------------|---------------|-------------|---------------------|-----------------------|---------------------|--------|
| 1 | CL02C0R5CO2ANN □ | 0.40×0.20 | 0.5 pF | 16 | ±0.25 pF | 0.22 | |
| 2 | CL02C010CO2ANN □ | | 1.0 pF | 16 | ±0.25 pF | 0.22 | |
| 3 | CL02C1R2CO2ANN □ | | 1.2 pF | 16 | ±0.25 pF | 0.22 | |
| 4 | CL02C1R5CO2ANN □ | | 1.5 pF | 16 | ±0.25 pF | 0.22 | |
| 5 | CL02C1R8CO2ANN □ | | 1.8 pF | 16 | ±0.25 pF | 0.22 | |
| 6 | CL02C020CO2ANN □ | | 2.0 pF | 16 | ±0.25 pF | 0.22 | |
| 7 | CL02C2R2CO2ANN □ | | 2.2 pF | 16 | ±0.25 pF | 0.22 | |
| 8 | CL02C2R7CO2ANN □ | | 2.7 pF | 16 | ±0.25 pF | 0.22 | |
| 9 | CL02C030CO2ANN □ | | 3.0 pF | 16 | ±0.25 pF | 0.22 | |
| 10 | CL02C3R3CO2ANN □ | | 3.3 pF | 16 | ±0.25 pF | 0.22 | |
| 11 | CL02C3R9CO2ANN □ | | 3.9 pF | 16 | ±0.25 pF | 0.22 | |
| 12 | CL02C4R7CO2ANN □ | | 4.7 pF | 16 | ±0.25 pF | 0.22 | |
| 13 | CL02C5R6DO2ANN □ | | 5.6 pF | 16 | ±0.5 pF | 0.22 | |
| 14 | CL02C6R8DO2ANN □ | | 6.8 pF | 16 | ±0.5 pF | 0.22 | |
| 15 | CL02C8R2DO2ANN □ | | 8.2 pF | 16 | ±0.5 pF | 0.22 | |
| 16 | CL02C090DO2ANN □ | | 9.0 pF | 16 | ±0.5 pF | 0.22 | |
| 17 | CL02C100JO2ANN □ | | 10 pF | 16 | ±5% | 0.22 | |
| 18 | CL02C150JO2ANN □ | | 15 pF | 16 | ±5% | 0.22 | |
| 19 | CL02C180JO2ANN □ | | 18 pF | 16 | ±5% | 0.22 | |
| 20 | CL02C220JO2ANN □ | | 22 pF | 16 | ±5% | 0.22 | |
| 21 | CL02C270JO2ANN □ | | 27 pF | 16 | ±5% | 0.22 | |
| 22 | CL02C330JO2ANN □ | | 33 pF | 16 | ±5% | 0.22 | |
| 23 | CL02C390JO2ANN □ | | 39 pF | 16 | ±5% | 0.22 | |
| 24 | CL02C470JO2ANN □ | | 47 pF | 16 | ±5% | 0.22 | |
| 25 | CL02C560JQ2ANN □ | | 56 pF | 6.3 | ±5% | 0.22 | |
| 26 | CL02C680JQ2ANN □ | | 68 pF | 6.3 | ±5% | 0.22 | |
| 27 | CL02C820JQ2ANN □ | | 82 pF | 6.3 | ±5% | 0.22 | |
| 28 | CL02C101JQ2ANN □ | | 100 pF | 6.3 | ±5% | 0.22 | |
| 1 | CL03C0R5CA3GNN □ | 0.60×0.30 | 0.5 pF | 25 | ±0.25 pF | 0.33 | High-Q |
| 2 | CL03C010CA3GNN □ | | 1.0 pF | 25 | ±0.25 pF | 0.33 | High-Q |
| 3 | CL03C1R2CA3GNN □ | | 1.2 pF | 25 | ±0.25 pF | 0.33 | High-Q |
| 4 | CL03C1R5CA3GNN □ | | 1.5 pF | 25 | ±0.25 pF | 0.33 | High-Q |
| 5 | CL03C1R8CA3GNN □ | | 1.8 pF | 25 | ±0.25 pF | 0.33 | High-Q |
| 6 | CL03C020CA3GNN □ | | 2.0 pF | 25 | ±0.25 pF | 0.33 | High-Q |
| 7 | CL03C2R2CA3GNN □ | | 2.2 pF | 25 | ±0.25 pF | 0.33 | High-Q |
| 8 | CL03C2R7CA3GNN □ | | 2.7 pF | 25 | ±0.25 pF | 0.33 | High-Q |
| 9 | CL03C030CA3GNN □ | | 3.0 pF | 25 | ±0.25 pF | 0.33 | High-Q |
| 10 | CL03C3R3CA3GNN □ | | 3.3 pF | 25 | ±0.25 pF | 0.33 | High-Q |
| 11 | CL03C3R9CA3GNN □ | | 3.9 pF | 25 | ±0.25 pF | 0.33 | High-Q |
| 12 | CL03C4R7CA3GNN □ | | 4.7 pF | 25 | ±0.25 pF | 0.33 | High-Q |
| 13 | CL03C5R6DA3GNN □ | | 5.6 pF | 25 | ±0.5 pF | 0.33 | High-Q |
| 14 | CL03C6R8DA3GNN □ | | 6.8 pF | 25 | ±0.5 pF | 0.33 | High-Q |
| 15 | CL03C8R2DA3GNN □ | | 8.2 pF | 25 | ±0.5 pF | 0.33 | High-Q |
| 16 | CL03C090DA3GNN □ | | 9.0 pF | 25 | ±0.5 pF | 0.33 | High-Q |
| 17 | CL03C100JA3GNN □ | | 10 pF | 25 | ±5% | 0.33 | High-Q |
| 18 | CL03C150JA3GNN □ | | 15 pF | 25 | ±5% | 0.33 | High-Q |
| 19 | CL03C180JA3GNN □ | | 18 pF | 25 | ±5% | 0.33 | High-Q |
| 20 | CL03C220JA3GNN □ | | 22 pF | 25 | ±5% | 0.33 | High-Q |
| 21 | CL03C270JA3GNN □ | | 27 pF | 25 | ±5% | 0.33 | High-Q |
| 22 | CL03C330JA3GNN □ | | 33 pF | 25 | ±5% | 0.33 | High-Q |
| 23 | CL03C390JA3ANN □ | | 39 pF | 25 | ±5% | 0.33 | |
| 24 | CL03C470JA3ANN □ | | 47 pF | 25 | ±5% | 0.33 | |
| 25 | CL03C101JA3ANN □ | | 100 pF | 25 | ±5% | 0.33 | |

Part Numbering System

General Capacitors

High Capacitance Capacitors

Super Small Size Capacitors

Medium-High Voltage Capacitors

Array Type Capacitors

Low ESL Capacitors

Reliability Test Condition

Premium Capacitors for Automotive Applications

Packaging Specification

Application Manual for Surface Mounting

※ □ mark means packaging code. If you want to learn the code or quantity in detail, please see p80.

Product Lineup (Super Small Size Capacitors -X7R)

| | Part Number | Size L×W (mm) | Capacitance | Rated Voltage (Vdc) | Capacitance Tolerance | Thickness Max. (mm) |
|---|------------------|---------------|-------------|---------------------|-----------------------|---------------------|
| 1 | CL02B101KP2NNN □ | 0.40×0.20 | 100pF | 10 | ±10% | 0.22 |
| 2 | CL02B151KP2NNN □ | | 150pF | 10 | ±10% | 0.22 |
| 3 | CL02B221KP2NNN □ | | 220pF | 10 | ±10% | 0.22 |
| 4 | CL02B331KP2NNN □ | | 330pF | 10 | ±10% | 0.22 |
| 5 | CL02B471KP2NNN □ | | 470pF | 10 | ±10% | 0.22 |
| 6 | CL02B681KP2NNN □ | | 680pF | 10 | ±10% | 0.22 |
| 7 | CL02B102KP2NNN □ | | 1.0nF | 10 | ±10% | 0.22 |
| 1 | CL03B331KO3NNN □ | 0.60×0.30 | 330pF | 16 | ±10% | 0.33 |
| 2 | CL03B102KO3NNN □ | | 1nF | 16 | ±10% | 0.33 |
| 3 | CL03B472KQ3NNN □ | | 4.7nF | 6.3 | ±10% | 0.33 |
| 4 | CL03B103KP3NNN □ | | 10nF | 10 | ±10% | 0.33 |

Product Lineup (Super Small Size Capacitors -X5R)

| | Part Number | Size L×W (mm) | Capacitance | Rated Voltage (Vdc) | Capacitance Tolerance | Thickness Max. (mm) |
|----|------------------|---------------|-------------|---------------------|-----------------------|---------------------|
| 1 | CL02A151KQ2NNN □ | 0.40×0.20 | 150pF | 6.3 | ±10% | 0.22 |
| 2 | CL02A221KQ2NNN □ | | 220pF | 6.3 | ±10% | 0.22 |
| 3 | CL02A331KQ2NNN □ | | 330pF | 6.3 | ±10% | 0.22 |
| 4 | CL02A471KQ2NNN □ | | 470pF | 6.3 | ±10% | 0.22 |
| 5 | CL02A681KQ2NNN □ | | 680pF | 6.3 | ±10% | 0.22 |
| 6 | CL02A102KQ2NNN □ | | 1nF | 6.3 | ±10% | 0.22 |
| 7 | CL02A152KQ2NNN □ | | 1.5nF | 6.3 | ±10% | 0.22 |
| 8 | CL02A222KQ2NNN □ | | 2.2nF | 6.3 | ±10% | 0.22 |
| 9 | CL02A332KQ2NNN □ | | 3.2nF | 6.3 | ±10% | 0.22 |
| 10 | CL02A472KQ2NNN □ | | 4.7nF | 6.3 | ±10% | 0.22 |
| 11 | CL02A682KQ2NNN □ | | 6.8nF | 6.3 | ±10% | 0.22 |
| 12 | CL02A103KQ2NNN □ | | 10nF | 6.3 | ±10% | 0.22 |
| 13 | CL02A104KQ2NNN □ | | 100nF | 6.3 | ±10% | 0.22 |
| 1 | CL03A103KP3NNN □ | 0.60×0.30 | 10nF | 10 | ±10% | 0.33 |
| 2 | CL03A223KQ3NNN □ | | 22nF | 6.3 | ±10% | 0.33 |
| 3 | CL03A473KQ3NNN □ | | 47nF | 6.3 | ±10% | 0.33 |
| 4 | CL03A104MA3NNN □ | | 100nF | 25 | ±20% | 0.33 |
| 5 | CL03A104KO3NNN □ | | 100nF | 16 | ±10% | 0.33 |
| 6 | CL03A104KP3NNN □ | | 100nF | 10 | ±10% | 0.33 |
| 7 | CL03A104KQ3NNN □ | | 100nF | 6.3 | ±10% | 0.33 |
| 8 | CL03A224KQ3NNN □ | | 220nF | 6.3 | ±10% | 0.33 |
| 9 | CL03A224KP3NNN □ | | 200nF | 10 | ±10% | 0.33 |
| 10 | CL03A105MQ3CSN □ | | 1μF | 6.3 | ±20% | 0.35 |

※ □ mark means packaging code. If you want to learn the code or quantity in detail, please see p80.

Medium-High Voltage Capacitors

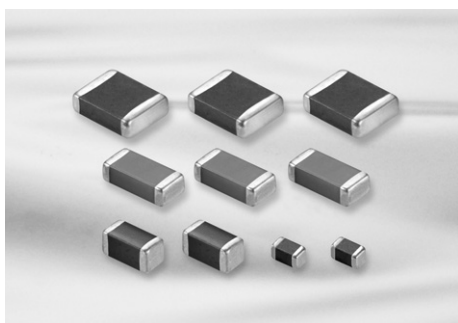

Feature

- Highly reliable performance
- Operating at high voltage level
- Wide voltage level: from 100V to 3000V
- High withstanding voltage
- Tape & reel surface mount assembly

Application

- Switching Power Circuit(SMPS)
- Lighting Ballast, LCD back lighting inverter
- DC-DC converter input filter, snubber circuit
- Phone, Fax, Modem
- Network(IEEE802.3)
 - ※ For using special purpose like Military, Medical, Aviation, Automobile device should be following a special specification.

Structure and Dimensions

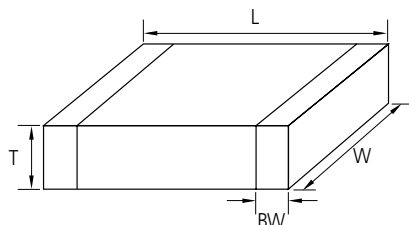

| Code | EIA Code | Dimension(mm) | | | |
|------|----------|---------------|----------|-----------|--------------|
| | | L | W | T | BW |
| 10 | 0603 | 1.6±0.1 | 0.8±0.1 | 0.8±0.1 | 0.3±0.2 |
| 21 | 0805 | 2.0±0.1 | 1.25±0.1 | 1.25±0.1 | 0.5+0.2/-0.3 |
| 31 | 1206 | 3.2±0.2 | 1.6±0.2 | 1.6±0.2 | 0.5±0.3 |
| | | 3.2±0.15 | 1.6±0.15 | 0.85±0.15 | |
| 32 | 1210 | 3.2±0.3 | 2.5±0.2 | 2.5±0.2 | 0.6±0.3 |
| 42 | 1808 | 4.5±0.4 | 2.0±0.2 | 2.0±0.2 | 0.8±0.3 |
| 43 | 1812 | 4.5±0.4 | 3.2±0.3 | 2.5±0.2 | 0.8±0.3 |
| 55 | 2220 | 5.7±0.4 | 5.0±0.4 | 2.5±0.2 | 1.0±0.3 |

Part Numbering System

General Capacitors

High Capacitance Capacitors

Super Small Size Capacitors

Medium-High Voltage Capacitors

Array Type Capacitors

Low ESL Capacitors

Reliability Test Condition

Premium Capacitors for Automotive Applications

Packaging Specification

Application Manual for Surface Mounting



Medium-High Voltage Capacitors Table (C0G)

| Vr | Size(mm) | Capacitance | | | | | | | | | | | | | | | | | | | | | | | | | |
|------|------------|-------------|-----|-----|-----|-----|-----|------|-----|-----|-----|-----|-----|-----|-----|-----|-----|-----|-----|----|----|----|----|----|----|----|----|
| | | (pF) | | | | | | (nF) | | | | | | | | | | | | | | | | | | | |
| | | 330 | 390 | 470 | 560 | 680 | 820 | 1 | 1.2 | 1.5 | 1.8 | 2.2 | 2.7 | 3.3 | 3.9 | 4.7 | 5.6 | 6.8 | 8.2 | 10 | 12 | 15 | 18 | 22 | 27 | 33 | 47 |
| 100V | 0603(1608) | ■ | | | | | | | | | | | | | | | | | | | | | | | | | |
| | 0805(2012) | ■ | | | | | | | | | | | | | | | | | | | | | | | | | |
| | 1206(3216) | ■ | | | | | | | | | | | | | | | | | | | | | | | | | |
| | 1210(3225) | | | | | | | ■ | | | | | | | | | | | | | | | | | | | |
| | 1812(4532) | | | | | | | | | | | | | ■ | | | | | | | | | | | | | |
| | 2220(5750) | | | | | | | | | | | | | | | | ■ | | | | | | | | | | |
| 200V | 0603(1608) | ■ | | | | | | | | | | | | | | | | | | | | | | | | | |
| | 0805(2012) | ■ | | | | | | | | | | | | | | | | | | | | | | | | | |
| | 1206(3216) | ■ | | | | | | | | | | | | | | | | | | | | | | | | | |
| | 1210(3225) | | | | | | | ■ | | | | | | | | | | | | | | | | | | | |
| | 1812(4532) | | | | | | | | | | | | | ■ | | | | | | | | | | | | | |
| | 2220(5750) | | | | | | | | | | | | | | | | ■ | | | | | | | | | | |
| 250V | 0603(1608) | ■ | | | | | | | | | | | | | | | | | | | | | | | | | |
| | 0805(2012) | ■ | | | | | | | | | | | | | | | | | | | | | | | | | |
| | 1206(3216) | ■ | | | | | | | | | | | | | | | | | | | | | | | | | |
| | 1210(3225) | | | | | | | ■ | | | | | | | | | | | | | | | | | | | |
| | 1812(4532) | | | | | | | | | | | | | ■ | | | | | | | | | | | | | |
| | 2220(5750) | | | | | | | | | | | | | | | | ■ | | | | | | | | | | |
| 500V | 1206(3216) | ■ | | | | | | | | | | | | | | | | | | | | | | | | | |
| | 1210(3225) | ■ | | | | | | ■ | | | | | | | | | | | | | | | | | | | |
| | 1812(4532) | ■ | | | | | | | | | | | | | | | | | | | | | | | | | |
| | 2220(5750) | | | | | | | | | | | | | ■ | | | | | | | | | | | | | |
| 630V | 1206(3216) | ■ | | | | | | | | | | | | | | | | | | | | | | | | | |
| | 1210(3225) | ■ | | | | | | ■ | | | | | | | | | | | | | | | | | | | |
| | 1812(4532) | ■ | | | | | | | | | | | | | | | | | | | | | | | | | |
| | 2220(5750) | | | | | | | | | | | | | ■ | | | | | | | | | | | | | |



Medium-High Voltage Capacitors Table (X7R)

| Size(mm) | Vr(V) | Capacitance (nF) | | | | | | | | | | | | | | | |
|----------|------------|------------------|----|----|----------------|----|----|---------------|-----|-----|-----|-----|-----|-----|------|------|------|
| | | 4.7 | 10 | 15 | 22 | 33 | 47 | 68 | 100 | 150 | 220 | 330 | 470 | 680 | 1000 | 1500 | 2200 |
| 100V | 0603(1608) | ■ | | | | | | | | | | | | | | | |
| | 0805(2012) | ■ | | | | | | | | | | | | | | | |
| | 1206(3216) | ■ | | | | | | | | | | | | | | | |
| | 1210(3225) | ■ | | | | | | | | | | | | | | | |
| | 1812(4532) | | | | | | | | ■ | | | | | | | | |
| | 2220(5750) | | | | | | | | | | | | | ■ | | | |
| 200V | 0805(2012) | ■ | | | | | | | | | | | | | | | |
| | 1206(3216) | ■ | | | | | | | | | | | | | | | |
| | 1210(3225) | | | | | | | ■ | | | | | | | | | |
| | 1812(4532) | | | | | ■ | | | | | | | | | | | |
| | 2220(5750) | | | | | | | | | | | ■ | | | | | |
| 250V | 0805(2012) | ■ | | | | | | | | | | | | | | | |
| | 1206(3216) | | | | | ■ | | | | | | | | | | | |
| | 1210(3225) | | | | | | | ■ | | | | | | | | | |
| | 1812(4532) | | | | | | | | | ■ | | | | | | | |
| | 2220(5750) | | | | | | | | | | | ■ | | | | | |
| 350V | 1206(3216) | ■ (Tmax =1.0) | | | ■ (Tmax =1.25) | | | ■ (Tmax =1.8) | | | | | | | | | |
| 500V | 1206(3216) | ■ | | | | | | | | | | | | | | | |
| | 1210(3225) | ■ | | | | | | | | | | | | | | | |
| | 1812(4532) | ■ | | ■ | | | | | | | | | | | | | |
| | 2220(5750) | | | | | | | | | ■ | | | | | | | |
| 630V | 1206(3216) | ■ | | | | | | | | | | | | | | | |
| | 1210(3225) | ■ | | | | | | | | | | | | | | | |
| | 1812(4532) | ■ | | ■ | | | | | | | | | | | | | |
| | 2220(5750) | | | | | | | | | ■ | | | | | | | |

Medium-High Voltage Capacitors Table (X7R)

| Size(mm) | Vr(V) | Capacitance (nF) | | | | | | | | | | | | | | | |
|----------|------------|------------------|-----|-----|-----|-----|-----|----|----|----|----|----|----|-----|-----|-----|-----|
| | | 1 | 1.5 | 2.2 | 3.3 | 4.7 | 6.8 | 10 | 15 | 22 | 33 | 47 | 68 | 100 | 150 | 220 | 330 |
| 1K | 1206(3216) | ■ | | | | | | | | | | | | | | | |
| | 1210(3225) | ■ | | | | | | | | | | | | | | | |
| | 1812(4532) | ■ | | | | | | | | | | | | | | | |
| | 2220(5750) | | | | | | | | | | | | ■ | | | | |
| 2KV | 1206(3216) | ■ | | | | | | | | | | | | | | | |
| | 1210(3225) | ■ | | | | | | | | | | | | | | | |
| | 1808(4520) | ■ | | | | | | | | | | | | | | | |
| | 1812(4532) | ■ | | | | | | | | | | | | | | | |
| | 2220(5750) | ■ | | | | | | | | | | | | | | | |
| 3KV | 1808(4520) | ■ | | | | | | | | | | | | | | | |

Part Numbering System

General Capacitors

High Capacitance Capacitors

Super Small Size Capacitors

Medium-High Voltage Capacitors

Array Type Capacitors

Low ESL Capacitors

Reliability Test Condition

Premium Capacitors for Automotive Applications

Packaging Specification

Application Manual for Surface Mounting



Product Lineup (Medium-High Voltage Capacitors-C0G)

| | Part Number | Size L×W (mm) | Capacitance | Rated Voltage (Vdc) | Capacitance Tolerance | Thickness Max. (mm) |
|----|-------------------|---------------|-------------|---------------------|-----------------------|---------------------|
| 1 | CL10C100JC8NNN □ | 1.60×0.80 | 10pF | 100 | ±5% | 0.90 |
| 2 | CL10C150JC8NNN □ | | 15pF | 100 | ±5% | 0.90 |
| 3 | CL10C330JC8NNN □ | | 33pF | 100 | ±5% | 0.90 |
| 4 | CL10C390JC8NNN □ | | 39pF | 100 | ±5% | 0.90 |
| 5 | CL10C470JC8NNN □ | | 47pF | 100 | ±5% | 0.90 |
| 6 | CL10C560JC8NNN □ | | 560pF | 100 | ±5% | 0.90 |
| 7 | CL10C101JC8NNN □ | | 100pF | 100 | ±5% | 0.90 |
| 8 | CL10C121JC8NNN □ | | 120pF | 100 | ±5% | 0.90 |
| 9 | CL10C151JC8NNN □ | | 150pF | 100 | ±5% | 0.90 |
| 10 | CL10C331JC8NNN □ | | 330pF | 100 | ±5% | 0.90 |
| 11 | CL10C331JD8NNN □ | | 330pF | 200 | ±5% | 0.90 |
| 12 | CL10C331JE8NNN □ | | 330pF | 250 | ±5% | 0.90 |
| 13 | CL10C391JD8NNN □ | | 390pF | 200 | ±5% | 0.90 |
| 14 | CL10C391JE8NNN □ | | 390pF | 250 | ±5% | 0.90 |
| 15 | CL10C471JC8NNN □ | | 470pF | 100 | ±5% | 0.90 |
| 16 | CL10C471JD8NNN □ | | 470pF | 200 | ±5% | 0.90 |
| 17 | CL10C471JE8NNN □ | | 470pF | 250 | ±5% | 0.90 |
| 18 | CL10C561JD8NNN □ | | 560pF | 200 | ±5% | 0.90 |
| 19 | CL10C561JE8NNN □ | | 560pF | 250 | ±5% | 0.90 |
| 20 | CL10C681JC8NNN □ | | 680pF | 100 | ±5% | 0.90 |
| 21 | CL10C681JD8NNN □ | | 680pF | 200 | ±5% | 0.90 |
| 22 | CL10C681JE8NNN □ | | 680pF | 250 | ±5% | 0.90 |
| 23 | CL10C821JC8NNN □ | | 820pF | 100 | ±5% | 0.90 |
| 24 | CL10C102JC8NNN □ | | 1nF | 100 | ±5% | 0.90 |
| 25 | CL10C122JC8NNN □ | | 1.2nF | 100 | ±5% | 0.90 |
| 1 | CL21C100JCANNN □ | 2.00×1.25 | 10pF | 100 | ±5% | 0.75 |
| 2 | CL21C120JCANNN □ | | 12pF | 100 | ±5% | 0.75 |
| 3 | CL21C150JDCNNN □ | | 15pF | 200 | ±5% | 0.95 |
| 4 | CL21C150JCANNN □ | | 15pF | 100 | ±5% | 0.75 |
| 5 | CL21C180JDCNNN □ | | 18pF | 200 | ±5% | 0.95 |
| 6 | CL21C180JCANNN □ | | 18pF | 100 | ±5% | 0.75 |
| 7 | CL21C220JCANNN □ | | 22pF | 100 | ±5% | 0.75 |
| 8 | CL21C270JCANNN □ | | 27pF | 100 | ±5% | 0.75 |
| 9 | CL21C330JCANNN □ | | 33pF | 100 | ±5% | 0.75 |
| 10 | CL21C330JDCNNN □ | | 33pF | 200 | ±5% | 0.95 |
| 11 | CL21C390JDCNNN □ | | 39pF | 200 | ±5% | 0.95 |
| 12 | CL21C470JCANNN □ | | 47pF | 100 | ±5% | 0.75 |
| 13 | CL21C470JDCNNN □ | | 47pF | 200 | ±5% | 0.95 |
| 14 | CL21C560JCCNNN □ | | 56pF | 100 | ±5% | 0.95 |
| 15 | CL21C560JDCNNN □ | | 56pF | 200 | ±5% | 0.95 |
| 16 | CL21C680JCANNN □ | | 68pF | 100 | ±5% | 0.75 |
| 17 | CL21C680JDCNNN □ | | 68pF | 200 | ±5% | 0.95 |
| 18 | CL21C820JCCNNN □ | | 82pF | 100 | ±5% | 0.95 |
| 19 | CL21C101JDCNNN □ | | 100pF | 200 | ±5% | 0.95 |
| 20 | CL21C101J ECNNN □ | | 100pF | 250 | ±5% | 0.95 |
| 21 | CL21C101JCANNN □ | | 100pF | 100 | ±5% | 0.75 |
| 22 | CL21C121JDCNNN □ | | 120pF | 200 | ±5% | 0.95 |
| 23 | CL21C151JCANNN □ | | 150pF | 100 | ±5% | 0.75 |
| 24 | CL21C221JCANNN □ | | 220pF | 100 | ±5% | 0.75 |
| 25 | CL21C221JDCNNN □ | | 220pF | 200 | ±5% | 0.95 |

※ □ mark means packaging code. If you want to learn the code or quantity in detail, please see p80.

Product Lineup (Medium-High Voltage Capacitors-C0G)

| | Part Number | Size L×W (mm) | Capacitance | Rated Voltage (Vdc) | Capacitance Tolerance | Thickness Max. (mm) |
|----|-----------------|---------------|-------------|---------------------|-----------------------|---------------------|
| 26 | CL21C331JCANN □ | 2.00×1.25 | 330pF | 100 | ±5% | 0.75 |
| 27 | CL21C471JCCNN □ | | 470pF | 100 | ±5% | 0.95 |
| 28 | CL21C561JCCNN □ | | 560pF | 100 | ±5% | 0.95 |
| 29 | CL21C681JCCNN □ | | 680pF | 100 | ±5% | 0.95 |
| 30 | CL21C102JCFNN □ | | 1nF | 100 | ±5% | 1.35 |
| 31 | CL21C102JDFNN □ | | 1nF | 200 | ±5% | 1.35 |
| 32 | CL21C272JDFNN □ | | 2.7nF | 200 | ±5% | 1.35 |
| 33 | CL21C272JEFNN □ | | 2.7nF | 250 | ±5% | 1.35 |
| 34 | CL21C472JCFNN □ | | 4.7nF | 100 | ±5% | 1.35 |
| 1 | CL31C150JGFNN □ | | 3.20×1.60 | 15pF | 500 | ±5% |
| 2 | CL31C180JGFNN □ | 18pF | | 500 | ±5% | 1.40 |
| 3 | CL31C220JGFNN □ | 22pF | | 500 | ±5% | 1.40 |
| 4 | CL31C220JHNN □ | 22pF | | 2000 | ±5% | 1.80 |
| 5 | CL31C270JGFNN □ | 27pF | | 500 | ±5% | 1.40 |
| 6 | CL31C330JGFNN □ | 33pF | | 500 | ±5% | 1.40 |
| 7 | CL31C390JGFNN □ | 39pF | | 500 | ±5% | 1.40 |
| 8 | CL31C470JHFNN □ | 47pF | | 630 | ±5% | 1.40 |
| 9 | CL31C470JGFNN □ | 47pF | | 500 | ±5% | 1.40 |
| 10 | CL31C470JHNN □ | 47pF | | 2000 | ±5% | 1.80 |
| 11 | CL31C560JGFNN □ | 56pF | | 500 | ±5% | 1.40 |
| 12 | CL31C680JCCNN □ | 68pF | | 100 | ±5% | 1.00 |
| 13 | CL31C680JHFNN □ | 68pF | | 630 | ±5% | 1.40 |
| 14 | CL31C680JGFNN □ | 68pF | | 500 | ±5% | 1.40 |
| 15 | CL31C680JIFNN □ | 68pF | | 1000 | ±5% | 1.40 |
| 16 | CL31C820JGFNC □ | 82pF | | 500 | ±5% | 1.40 |
| 17 | CL31C101JGFNN □ | 100pF | | 500 | ±5% | 1.40 |
| 18 | CL31C101JHFNN □ | 100pF | | 630 | ±5% | 1.40 |
| 19 | CL31C101JIFNN □ | 100pF | | 1000 | ±5% | 1.40 |
| 20 | CL31C101JHNN □ | 100pF | | 2000 | ±5% | 1.80 |
| 21 | CL31C121JGFNN □ | 120pF | | 500 | ±5% | 1.40 |
| 22 | CL31C151JGFNN □ | 150pF | | 500 | ±5% | 1.40 |
| 23 | CL31C181JGFNN □ | 180pF | | 500 | ±5% | 1.40 |
| 24 | CL31C221JGFNN □ | 220pF | | 500 | ±5% | 1.40 |
| 25 | CL31C271JGFNN □ | 270pF | | 500 | ±5% | 1.40 |
| 26 | CL31C271JCCNN □ | 270pF | | 100 | ±5% | 1.00 |
| 27 | CL31C331JGFNN □ | 330pF | | 500 | ±5% | 1.40 |
| 28 | CL31C331JHNN □ | 330pF | | 1000 | ±5% | 1.80 |
| 29 | CL31C391JCCNN □ | 390pF | | 100 | ±5% | 1.00 |
| 30 | CL31C471JGFNN □ | 470pF | | 500 | ±5% | 1.40 |
| 31 | CL31C561JCCNN □ | 560pF | | 100 | ±5% | 1.00 |
| 32 | CL31C561JGFNN □ | 560pF | | 500 | ±5% | 1.40 |
| 33 | CL31C681JGFNN □ | 680pF | | 500 | ±5% | 1.80 |
| 34 | CL31C102JCCNN □ | 1nF | | 100 | ±5% | 1.00 |
| 35 | CL31C102JGHNN □ | 1nF | | 500 | ±5% | 1.80 |
| 36 | CL31C152JCCNN □ | 1.5nF | | 100 | ±5% | 1.00 |
| 37 | CL31C222JCCNN □ | 2.2nF | | 100 | ±5% | 1.00 |
| 38 | CL31C332JGHNN □ | 3.3nF | | 500 | ±5% | 1.80 |
| 39 | CL31C332JHNN □ | 3.3nF | | 630 | ±5% | 1.80 |
| 40 | CL31C392JCHNN □ | 3.9nF | | 100 | ±5% | 1.80 |
| 41 | CL31C822JDHNN □ | 8.2nF | | 200 | ±5% | 1.80 |

- Part Numbering System
- General Capacitors
- High Capacitance Capacitors
- Super Small Size Capacitors
- Medium-High Voltage Capacitors
- Array Type Capacitors
- Low ESL Capacitors
- Reliability Test Condition
- Premium Capacitors for Automotive Applications
- Packaging Specification
- Application Manual for Surface Mounting

※ □ mark means packaging code. If you want to learn the code or quantity in detail, please see p80.



Product Lineup (Medium-High Voltage Capacitors-C0G)

| | Part Number | Size L×W (mm) | Capacitance | Rated Voltage (Vdc) | Capacitance Tolerance | Thickness Max. (mm) |
|----|-------------------|---------------|-------------|---------------------|-----------------------|---------------------|
| 42 | CL31C822JEHNNN □ | 3.20×1.60 | 8.2nF | 250 | ±5% | 1.80 |
| 43 | CL31C183JCHNNN □ | | 18nF | 100 | ±5% | 1.80 |
| 1 | CL32C101JJFNNN □ | 3.20×2.50 | 100pF | 2000 | ±5% | 1.45 |
| 2 | CL32C471JJJNNN □ | | 470pF | 2000 | ±5% | 2.70 |
| 3 | CL32C821JIIJNNN □ | | 820pF | 1000 | ±5% | 2.70 |
| 4 | CL32C103JGJNNN □ | | 10nF | 500 | ±5% | 2.70 |
| 5 | CL32C103JHJNNN □ | | 10nF | 630 | ±5% | 2.70 |
| 6 | CL32C273JDJNNN □ | | 27nF | 200 | ±5% | 2.70 |
| 7 | CL32C273JEJNNN □ | | 27nF | 250 | ±5% | 2.70 |
| 8 | CL32C563JCJNNN □ | | 56nF | 100 | ±5% | 2.70 |
| 1 | CL42C100JKFNNN □ | 4.50×2.00 | 10pF | 3000 | ±5% | 1.45 |
| 2 | CL42C151JKINNN □ | | 150pF | 3000 | ±5% | 2.20 |
| 3 | CL42C221JJHNNN □ | | 220pF | 2000 | ±5% | 1.80 |
| 1 | CL43C391JKJNNN □ | 4.50×3.20 | 390pF | 2000 | ±5% | 2.70 |
| 2 | CL43C102JIIHNNN □ | | 1.0nF | 1000 | ±5% | 1.80 |
| 3 | CL43C122JIIJNNN □ | | 1.2nF | 1000 | ±5% | 2.20 |
| 4 | CL43C182JIIJNNN □ | | 1.8nF | 1000 | ±5% | 2.70 |
| 5 | CL43C182JJJNNN □ | | 1.8nF | 2000 | ±5% | 2.70 |
| 6 | CL43C223JGJNNN □ | | 22nF | 500 | ±5% | 2.70 |
| 7 | CL43C223JHJNNN □ | | 22nF | 630 | ±5% | 2.70 |
| 8 | CL43C473JDJNNN □ | | 47nF | 200 | ±5% | 2.70 |
| 9 | CL43C473JEJNNN □ | | 47nF | 250 | ±5% | 2.70 |
| 10 | CL43C563JCJNNN □ | | 56nF | 100 | ±5% | 2.70 |
| 1 | CL55C102JJJNNN □ | 5.70×5.00 | 1nF | 2000 | ±5% | 2.70 |
| 2 | CL55C102JKJNNN □ | | 1nF | 3000 | ±5% | 2.70 |
| 3 | CL55C362JIIJNNN □ | | 3.3nF | 1000 | ±5% | 2.70 |
| 4 | CL55C223JGJNNN □ | | 22nF | 500 | ±5% | 2.70 |
| 5 | CL55C223JHJNNN □ | | 22nF | 630 | ±5% | 2.70 |
| 6 | CL55C473JDJNNN □ | | 47nF | 200 | ±5% | 2.70 |
| 7 | CL55C473JEJNNN □ | | 47nF | 250 | ±5% | 2.70 |
| 8 | CL55C683JCJNNN □ | | 68nF | 100 | ±5% | 2.70 |

※ □ mark means packaging code. If you want to learn the code or quantity in detail, please see p80.

Product Lineup (Medium-High Voltage Capacitors-X7R)

| | Part Number | Size L×W (mm) | Capacitance | Rated Voltage (Vdc) | Capacitance Tolerance | Thickness Max. (mm) |
|----|------------------|---------------|-------------|---------------------|-----------------------|---------------------|
| 1 | CL10B102KC8NNN □ | 1.60×0.80 | 1nF | 100 | ±10% | 0.90 |
| 2 | CL10B472KC8NNN □ | | 4.7nF | 100 | ±10% | 0.90 |
| 3 | CL10B103KC8NNN □ | | 10nF | 100 | ±10% | 0.90 |
| 1 | CL21B221KDCNNN □ | 2.00×1.25 | 220pF | 200 | ±10% | 0.95 |
| 2 | CL21B221KCANNN □ | | 220pF | 100 | ±10% | 0.75 |
| 3 | CL21B331KDCNNN □ | | 330pF | 200 | ±10% | 0.95 |
| 4 | CL21B471KCANNN □ | | 470pF | 100 | ±10% | 0.75 |
| 5 | CL21B102KDCNNN □ | | 1nF | 200 | ±10% | 0.95 |
| 6 | CL21B102KCANNN □ | | 1nF | 100 | ±10% | 0.75 |
| 7 | CL21B222KDCNNN □ | | 2.2nF | 200 | ±10% | 0.95 |
| 8 | CL21B222KCANNN □ | | 2.2nF | 100 | ±10% | 0.75 |
| 9 | CL21B332KCANNN □ | | 3.3nF | 100 | ±10% | 0.75 |
| 10 | CL21B472KDCNNN □ | | 4.7nF | 200 | ±10% | 0.95 |
| 11 | CL21B472KCANNN □ | | 4.7nF | 100 | ±10% | 0.75 |
| 12 | CL21B682KCANNN □ | | 6.8nF | 100 | ±10% | 0.75 |
| 13 | CL21B103KDCNNN □ | | 10nF | 200 | ±10% | 0.95 |
| 14 | CL21B103KCANNN □ | | 10nF | 100 | ±10% | 0.75 |
| 15 | CL21B153KEFNNN □ | | 15nF | 250 | ±10% | 1.35 |
| 16 | CL21B153KDFNNN □ | | 15nF | 200 | ±10% | 1.35 |
| 17 | CL21B153KCCNNN □ | | 15nF | 100 | ±10% | 0.95 |
| 18 | CL21B223KCFNNN □ | | 22nF | 100 | ±10% | 1.35 |
| 19 | CL21B473KCFNNN □ | | 47nF | 100 | ±10% | 1.35 |
| 20 | CL21B683KCFNNN □ | | 68nF | 100 | ±10% | 1.35 |
| 21 | CL21B104KCFNNN □ | | 100nF | 100 | ±10% | 1.35 |
| 22 | CL21B154KCFNNN □ | | 150nF | 100 | ±10% | 1.35 |
| 23 | CL21B224KCFNNN □ | | 220nF | 100 | ±10% | 1.35 |
| 1 | CL31B221KGFNNN □ | 3.20×1.60 | 220pF | 500 | ±10% | 1.40 |
| 2 | CL31B471KGFNNN □ | | 470pF | 500 | ±10% | 1.40 |
| 3 | CL31B471KDCNNN □ | | 470pF | 200 | ±10% | 1.00 |
| 4 | CL31B102KJHNNN □ | | 1nF | 2000 | ±10% | 1.80 |
| 5 | CL31B102KIFNNN □ | | 1nF | 1000 | ±10% | 1.40 |
| 6 | CL31B102KGFNNN □ | | 1nF | 500 | ±10% | 1.40 |
| 7 | CL31B102KHFNNN □ | | 1nF | 630 | ±10% | 1.40 |
| 8 | CL31B152KGFNNN □ | | 1.5nF | 500 | ±10% | 1.40 |
| 9 | CL31B152KJHNNN □ | | 1.5nF | 2000 | ±10% | 1.80 |
| 10 | CL31B222KIFNNN □ | | 2.2nF | 1000 | ±10% | 1.40 |
| 11 | CL31B222KDCNNN □ | | 2.2nF | 200 | ±10% | 1.00 |
| 12 | CL31B222KGFNNN □ | | 2.2nF | 500 | ±10% | 1.40 |
| 13 | CL31B222KJHNNN □ | | 2.2nF | 2000 | ±10% | 1.80 |
| 14 | CL31B332KGFNNN □ | | 3.3nF | 500 | ±10% | 1.40 |
| 15 | CL31B332KIFNNN □ | | 3.3nF | 1000 | ±10% | 1.40 |
| 16 | CL31B472KGFNNN □ | | 4.7nF | 500 | ±10% | 1.40 |

- Part Numbering System
- General Capacitors
- High Capacitance Capacitors
- Super Small Size Capacitors
- Medium-High Voltage Capacitors
- Array Type Capacitors
- Low ESL Capacitors
- Reliability Test Condition
- Premium Capacitors for Automotive Applications
- Packaging Specification
- Application Manual for Surface Mounting

※ □ mark means packaging code. If you want to learn the code or quantity in detail, please see p80.



Product Lineup (Medium-High Voltage Capacitors-X7R)

| | Part Number | Size L×W (mm) | Capacitance | Rated Voltage (Vdc) | Capacitance Tolerance | Thickness Max. (mm) | |
|----|------------------|---------------|-------------|---------------------|-----------------------|---------------------|------|
| 17 | CL31B472KDCNNN □ | 3.20×1.60 | 4.7nF | 200 | ±10% | 1.00 | |
| 18 | CL31B682KGFNNN □ | | 6.8nF | 500 | ±10% | 1.40 | |
| 19 | CL31B103KHFNNN □ | | 10nF | 630 | ±10% | 1.40 | |
| 20 | CL31B103KGFNNN □ | | 10nF | 500 | ±10% | 1.40 | |
| 21 | CL31B103KFCSNN □ | | 10nF | 350 | ±10% | 1.00 | |
| 22 | CL31B153KDCNNN □ | | 15nF | 200 | ±10% | 1.00 | |
| 23 | CL31B153KFCSNN □ | | 15nF | 350 | ±10% | 1.00 | |
| 24 | CL31B153KCCNNN □ | | 15nF | 100 | ±10% | 1.00 | |
| 25 | CL31B153KGFNNN □ | | 15nF | 500 | ±10% | 1.40 | |
| 26 | CL31B153KHFNNN □ | | 15nF | 630 | ±10% | 1.40 | |
| 27 | CL31B223KDCNNN □ | | 22nF | 200 | ±10% | 1.00 | |
| 28 | CL31B223KCCNNN □ | | 22nF | 100 | ±10% | 1.00 | |
| 29 | CL31B223KFCSNN □ | | 22nF | 350 | ±10% | 1.00 | |
| 30 | CL31B223KGHNNN □ | | 22nF | 500 | ±10% | 1.80 | |
| 31 | CL31B223KHHNNN □ | | 22nF | 630 | ±10% | 1.80 | |
| 32 | CL31B333KDFNNN □ | | 33nF | 200 | ±10% | 1.40 | |
| 33 | CL31B333KFESNN □ | | 33nF | 350 | ±10% | 1.25 | |
| 34 | CL31B333KCCNNN □ | | 33nF | 100 | ±10% | 1.00 | |
| 35 | CL31B333KGHNNN □ | | 33nF | 500 | ±10% | 1.80 | |
| 36 | CL31B333KHHNNN □ | | 33nF | 630 | ±10% | 1.80 | |
| 37 | CL31B473KDFNNN □ | | 47nF | 200 | ±10% | 1.40 | |
| 38 | CL31B473KFHSNN □ | | 47nF | 350 | ±10% | 1.80 | |
| 39 | CL31B473KCCNNN □ | | 47nF | 100 | ±10% | 1.00 | |
| 40 | CL31B473KEHNNN □ | | 47nF | 250 | ±10% | 1.80 | |
| 41 | CL31B683KEHNNN □ | | 68nF | 250 | ±10% | 1.80 | |
| 42 | CL31B104KDHHNN □ | | 100nF | 200 | ±10% | 1.80 | |
| 43 | CL31B104KCFNNN □ | | 100nF | 100 | ±10% | 1.40 | |
| 44 | CL31B104KEHNNN □ | | 100nF | 250 | ±10% | 1.80 | |
| 45 | CL31B154KCHNNN □ | | 150nF | 100 | ±10% | 1.80 | |
| 46 | CL31B105KCHNNN □ | | 1μF | 100 | ±10% | 1.80 | |
| 47 | CL31B155KCHNNN □ | | 1.5μF | 100 | ±10% | 1.80 | |
| 48 | CL31B225KCHNNN □ | | 2.2μF | 100 | ±10% | 1.80 | |
| 1 | CL32B102KJFNNN □ | | 3.20×2.50 | 1nF | 2000 | ±10% | 1.45 |
| 2 | CL32B472KHFNNN □ | | | 4.7nF | 630 | ±10% | 1.45 |
| 3 | CL32B472KIFNNN □ | | | 4.7nF | 1000 | ±10% | 1.45 |
| 4 | CL32B682KIFNNN □ | | | 6.8nF | 1000 | ±10% | 1.45 |
| 5 | CL32B103KCFNNN □ | | | 10nF | 100 | ±10% | 1.45 |
| 6 | CL32B153KGFNNN □ | | | 15nF | 500 | ±10% | 1.45 |
| 7 | CL32B223KGFNNN □ | 22nF | | 500 | ±10% | 1.45 | |
| 8 | CL32B333KHHNNN □ | 33nF | | 630 | ±10% | 1.80 | |
| 9 | CL32B333KGHNNN □ | 33nF | | 500 | ±10% | 1.80 | |
| 10 | CL32B473KHHNNN □ | 47nF | | 630 | ±10% | 1.80 | |

※ □ mark means packaging code. If you want to learn the code or quantity in detail, please see p80.

Product Lineup (Medium-High Voltage Capacitors-X7R)

| | Part Number | Size L×W (mm) | Capacitance | Rated Voltage (Vdc) | Capacitance Tolerance | Thickness Max. (mm) |
|----|-------------------|---------------|-------------|---------------------|-----------------------|---------------------|
| 11 | CL32B473KDHNNN □ | 3.20×2.50 | 47nF | 200 | ±10% | 1.80 |
| 12 | CL32B473KGNHNN □ | | 47nF | 500 | ±10% | 1.80 |
| 13 | CL32B683KDINNN □ | | 68nF | 200 | ±10% | 2.20 |
| 14 | CL32B104KE JNNN □ | | 100nF | 250 | ±10% | 2.70 |
| 15 | CL32B104KDINNN □ | | 100nF | 200 | ±10% | 2.20 |
| 16 | CL32B154KCFNNN □ | | 150nF | 100 | ±10% | 1.45 |
| 17 | CL32B154KDJNNN □ | | 150nF | 200 | ±10% | 2.70 |
| 18 | CL32B154KEJNNN □ | | 150nF | 250 | ±10% | 2.70 |
| 19 | CL32B224KCHNNN □ | | 220nF | 100 | ±10% | 1.80 |
| 20 | CL32B224KDJNNN □ | | 220nF | 200 | ±10% | 2.70 |
| 21 | CL32B224KEJNNN □ | | 220nF | 250 | ±10% | 2.70 |
| 22 | CL32B334KCHNNN □ | | 330nF | 100 | ±10% | 1.80 |
| 23 | CL32B474KCINNN □ | | 470nF | 100 | ±10% | 2.20 |
| 24 | CL32B105KJNNN □ | | 1μF | 100 | ±10% | 2.70 |
| 25 | CL32B155KCHNNN □ | | 1.5μF | 100 | ±10% | 1.80 |
| 26 | CL32B225KJNNN □ | | 2.2μF | 100 | ±10% | 2.70 |
| 1 | CL43B102KJFNNN □ | 4.50×3.20 | 1nF | 2000 | ±10% | 1.45 |
| 2 | CL43B152KJFNNN □ | | 1.5nF | 2000 | ±10% | 1.45 |
| 3 | CL43B222KJFNNN □ | | 2.2nF | 1000 | ±10% | 1.45 |
| 4 | CL43B222KJFNNN □ | | 2.2nF | 2000 | ±10% | 1.45 |
| 5 | CL43B332KJFNNN □ | | 3.3nF | 2000 | ±10% | 1.45 |
| 6 | CL43B103KJFNNN □ | | 10nF | 1000 | ±10% | 1.45 |
| 7 | CL43B333KIJNNN □ | | 33nF | 1000 | ±10% | 2.70 |
| 8 | CL43B473KGFNNN □ | | 47nF | 500 | ±10% | 1.45 |
| 9 | CL43B473KHFNNN □ | | 47nF | 630 | ±10% | 1.45 |
| 10 | CL43B473KIJNNN □ | | 47nF | 1000 | ±10% | 2.70 |
| 11 | CL43B104KGINNN □ | | 100nF | 500 | ±10% | 2.20 |
| 12 | CL43B104KDFNNN □ | | 100nF | 200 | ±10% | 1.45 |
| 13 | CL43B104KHINNN □ | | 100nF | 630 | ±10% | 2.20 |
| 14 | CL43B224KCFNNN □ | | 220nF | 100 | ±10% | 1.45 |
| 15 | CL43B334KCFNNN □ | | 330nF | 100 | ±10% | 1.45 |
| 16 | CL43B474KEJNNN □ | | 470nF | 250 | ±10% | 2.70 |
| 17 | CL43B474KCHNNN □ | | 470nF | 100 | ±10% | 1.80 |
| 18 | CL43B474KDJNNN □ | | 470nF | 200 | ±10% | 2.70 |
| 19 | CL43B105KJNNN □ | | 1μF | 100 | ±10% | 2.70 |
| 1 | CL55B103KJHNNN □ | 5.70×5.00 | 10nF | 2000 | ±10% | 1.80 |
| 2 | CL55B473KIINNN □ | | 47nF | 1000 | ±10% | 2.20 |
| 3 | CL55B224KGJNNN □ | | 220nF | 500 | ±10% | 2.70 |
| 4 | CL55B224KHJNNN □ | | 220nF | 630 | ±10% | 2.70 |
| 5 | CL55B105KCHNNN □ | | 1μF | 100 | ±10% | 1.80 |
| 6 | CL55B105KDJNNN □ | | 1μF | 200 | ±10% | 2.70 |
| 7 | CL55B105KEJNNN □ | | 1μF | 250 | ±10% | 2.70 |
| 8 | CL55B475KJNNN □ | | 4.7uF | 100 | ±10% | 2.70 |

※ □mark means packaging code. If you want to learn the code or quantity in detail, please see p80.

- Part Numbering System
- General Capacitors
- High Capacitance Capacitors
- Super Small Size Capacitors
- Medium-High Voltage Capacitors
- Array Type Capacitors
- Low ESL Capacitors
- Reliability Test Condition
- Premium Capacitors for Automotive Applications
- Packaging Specification
- Application Manual for Surface Mounting

Array Type Capacitors

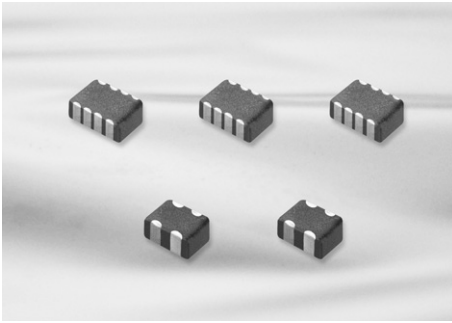

Feature

- Reduction in required space(more than 50%)
- Reduction in cost and time for replacement of PCB
- Reduction in amount of solder joints
- Easier PCB design
- Reduced waste from tape and reel packaging process
- It protect EMI bypassing digital signal line nose

Application

- A bypass for digital and analog signal line noise generated by telecommunication equipment and other common electronic circuits
- ※ For using special purpose like Military, Medical, Aviation, Automobile device should be following a special specification.

Structure and Dimensions

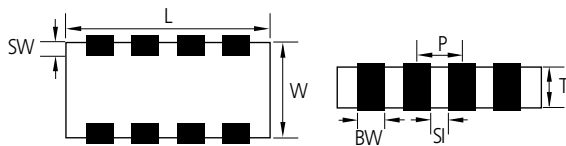

| Code | EIA Code | Dimension(mm) | | | | | |
|------|----------|---------------|-----------|--|-----------|-----------|-----------|
| | | L | W | T | BW | SW | P |
| A | 0906 | 0.90±0.05 | 0.60±0.05 | 0.45±0.05 | 0.25±0.05 | 0.15±0.1 | 0.45±0.05 |
| A | 0504 | 1.37±0.15 | 1.0±0.15 | 0.35±0.05 0.50±0.05 0.60±0.06 0.80±0.08 | 0.36±0.1 | 0.2±0.1 | 0.64±0.1 |
| A | 0805 | 2.0±0.15 | 1.25±0.15 | 0.85±0.1 | 0.5±0.2 | 0.25±0.15 | 1.0±0.1 |
| B | 0805 | 2.0±0.15 | 1.25±0.15 | 0.85±0.1 | 0.25±0.1 | 0.25±0.15 | 0.5±0.1 |
| B | 1206 | 3.2±0.15 | 1.6±0.15 | 0.85±0.15 | 0.4±0.2 | 0.3±0.15 | 0.8±0.2 |

Structure and Control Code

▪ A : ARRAY(2-element)

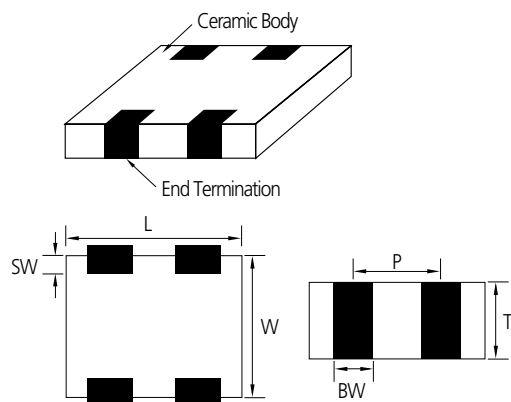

▪ B : ARRAY(4-element)

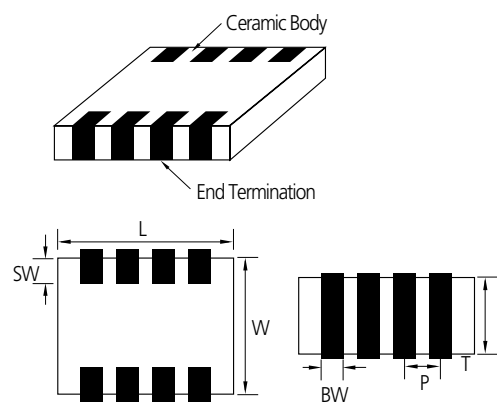

Array Type Capacitors Table (C0G, X5R, X7R, Y5V)

| TC | Size(mm) | Type | Vr(V) | Tmax (mm) | Capacitance (pF) | | | | | | | | |
|-----|------------|-----------|-------|-----------|------------------|----|----|----|-----|-----|--|--|--|
| | | | | | 10 | 22 | 27 | 47 | 100 | 470 | | | |
| C0G | 0504(1410) | 2-element | 25 | 0.88 | | | | | | | | | |
| | 1206(3216) | 4-element | 50 | 1.0 | | | | | | | | | |

| TC | Size(mm) | Type | Vr(V) | Tmax (mm) | Capacitance (nF) | | | | | | | | | | | | | | | |
|-----|------------|-----------|-------|-----------|------------------|-----|-----|----|----|----|-----|-----|-----|------|------|--|--|--|--|--|
| | | | | | 1 | 2.2 | 4.7 | 10 | 22 | 47 | 100 | 220 | 470 | 1000 | 2200 | | | | | |
| X5R | 0302(0906) | 2-element | 6.3 | 0.5 | | | | | | | | | | | | | | | | |
| | | | 10 | | | | | | | | | | | | | | | | | |
| | 0504(1410) | 2-element | 6.3 | 0.88 | | | | | | | | | | | | | | | | |
| | | | | 0.66 | | | | | | | | | | | | | | | | |
| | | | | 0.55 | | | | | | | | | | | | | | | | |
| | | | | 0.4 | | | | | | | | | | | | | | | | |
| | | | 10 | 0.88 | | | | | | | | | | | | | | | | |
| | | | | 0.66 | | | | | | | | | | | | | | | | |
| | | | | 0.55 | | | | | | | | | | | | | | | | |
| | | | | 0.4 | | | | | | | | | | | | | | | | |
| | | | 16 | 0.88 | | | | | | | | | | | | | | | | |
| | | | | 0.66 | | | | | | | | | | | | | | | | |
| | | | | 0.55 | | | | | | | | | | | | | | | | |
| | | | | 0.4 | | | | | | | | | | | | | | | | |
| | 25 | 0.88 | | | | | | | | | | | | | | | | | | |
| | | 0.66 | | | | | | | | | | | | | | | | | | |
| | | 0.55 | | | | | | | | | | | | | | | | | | |
| | 0805(2012) | 2-element | 6.3 | 0.95 | | | | | | | | | | | | | | | | |
| | | | 10 | | | | | | | | | | | | | | | | | |
| | | | 16 | | | | | | | | | | | | | | | | | |
| X7R | 0805(2012) | 4-element | 10 | 0.95 | | | | | | | | | | | | | | | | |
| | | | 16 | | | | | | | | | | | | | | | | | |
| | 1206(3216) | 4-element | 16 | 1.0 | | | | | | | | | | | | | | | | |
| | | | 25 | | | | | | | | | | | | | | | | | |
| | | | 50 | | | | | | | | | | | | | | | | | |
| Y5V | 1206(3216) | 4-element | 25 | 1.0 | | | | | | | | | | | | | | | | |
| | | | 50 | | | | | | | | | | | | | | | | | |

Part Numbering System

General Capacitors

High Capacitance Capacitors

Super Small Size Capacitors

Medium-High Voltage Capacitors

Array Type Capacitors

Low ESL Capacitors

Reliability Test Condition

Premium Capacitors for Automotive Applications

Packaging Specification

Application Manual for Surface Mounting

Product Lineup (Array Type Capacitors)

| | Part Number | Element Type | Size L × W (mm) | Capacitance | Rated Voltage (Vdc) | Capacitance Tolerance | Thickness Max. (mm) |
|----|--------------------|--------------|-----------------|-------------|---------------------|-----------------------|---------------------|
| 1 | CL14C270KA6NAN □ | 2-Array | 1.40 × 1.00 | 27pF | 25 | ±10% | 0.66 |
| 1 | CL31C100 JBCNBN □ | 4-Array | 3.20 × 1.60 | 10pF | 50 | ±5% | 1.0 |
| 2 | CL31C150 JBCNBN □ | | | 15pF | 50 | ±5% | 1.0 |
| 3 | CL31C220J BCNBN □ | | | 22pF | 50 | ±5% | 1.0 |
| 4 | CL31C270 JBCNBN □ | | | 27pF | 50 | ±5% | 1.0 |
| 5 | CL31C330KBCNBN □ | | | 33pF | 50 | ±10% | 1.0 |
| 6 | CL31C390KBCNBN □ | | | 39pF | 50 | ±10% | 1.0 |
| 7 | CL31C680J BCNBN □ | | | 68pF | 50 | ±5% | 1.0 |
| 8 | CL31C820 JBCNBN □ | | | 82pF | 50 | ±5% | 1.0 |
| 9 | CL31C101JB CNBN □ | | | 100pF | 50 | ±5% | 1.0 |
| 10 | CL31C151KBCNBN □ | | | 150pF | 50 | ±10% | 1.0 |
| 11 | CL31C181JB CNBN □ | | | 180pF | 50 | ±5% | 1.0 |
| 12 | CL31C331J B CNBN □ | | | 330pF | 50 | ±5% | 1.0 |
| 13 | CL31C471JB CNBN □ | | | 470pF | 50 | ±5% | 1.0 |
| 1 | CL21B471KBCNBN □ | 4-Array | 2.00 × 1.25 | 470pF | 50 | ±10% | 0.95 |
| 2 | CL21B104KOCNBN □ | | | 100nF | 16 | ±10% | 0.95 |
| 3 | CL21B104MPCNBN □ | | | 100nF | 10 | ±20% | 0.95 |
| 1 | CL31B102MBCNBN □ | 4-Array | 3.20 × 1.60 | 1nF | 50 | ±20% | 1.00 |
| 2 | CL31B103MBCNBN □ | | | 10nF | 50 | ±20% | 1.00 |
| 3 | CL31B153KBCNBN □ | | | 15nF | 50 | ±10% | 1.00 |
| 4 | CL31B473KACNBN □ | | | 47nF | 25 | ±10% | 1.00 |
| 5 | CL31B104KACNBN □ | | | 100nF | 25 | ±10% | 1.00 |
| 6 | CL31B104KOCNBN □ | | | 100nF | 16 | ±10% | 1.00 |
| 1 | CL09A104KQ4SAN □ | 2-Array | 0.90 × 0.60 | 100nF | 6.3 | ±10% | 0.5 |
| 2 | CL09A104KP4SAN □ | | | 100nF | 10 | ±10% | 0.5 |
| 1 | CL14A104KA6NAN □ | 2-Array | 1.40 × 1.00 | 100nF | 25 | ±10% | 0.66 |
| 2 | CL14A104KO6NAN □ | | | 100nF | 16 | ±10% | 0.66 |
| 3 | CL14A104KP6NAN □ | | | 100nF | 10 | ±10% | 0.66 |
| 1 | CL14A105MA5NAN □ | 2-Array | 1.40 × 1.00 | 1μF | 25 | ±20% | 0.55 |
| 2 | CL14A105KP8NAN □ | | | 1μF | 10 | ±10% | 0.88 |
| 3 | CL14A105MO3NAN □ | | | 1μF | 16 | ±20% | 0.4 |
| 4 | CL14A105MO8NAN □ | | | 1μF | 16 | ±20% | 0.88 |
| 5 | CL14A105MP3NAN □ | | | 1μF | 10 | ±20% | 0.4 |
| 6 | CL14A105MP5NAN □ | | | 1μF | 10 | ±20% | 0.55 |
| 7 | CL14A225KP8NAN □ | | | 2.2μF | 10 | ±10% | 0.88 |
| 8 | CL14A225KQ8NAN □ | | | 2.2μF | 6.3 | ±10% | 0.88 |
| 9 | CL14A105MO5NAN □ | | | 1μF | 16 | ±20% | 0.55 |
| 1 | CL21A105KOCNAN □ | 2-Array | 2.00 × 1.25 | 1μF | 16 | ±10% | 0.95 |
| 2 | CL21A105MPCNAN □ | 2-Array | 1.40 × 1.00 | 1μF | 10 | ±20% | 0.88 |
| 1 | CL31F473ZB CNBN □ | 4-Array | 3.20 × 1.60 | 47nF | 50 | 80%/-20% | 1.0 |
| 2 | CL31F104ZACNBN □ | | | 100nF | 25 | 80%/-20% | 1.0 |

※ □ mark means packaging code. If you want to learn the code or quantity in detail, please see p80.

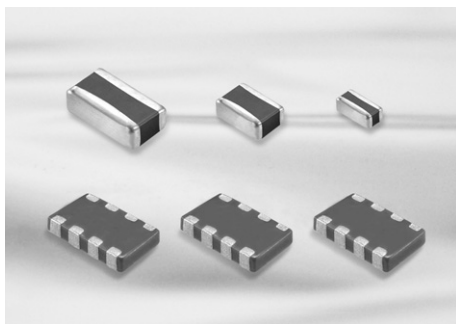

Feature

- Low ESL, good for noise reduction for high frequency
- Highly reliable tolerance and high speed automatic chip placement on PCBs
- Highly reliable performance
- Highly resistant termination metal
- Tape & reel for surface mount assembly

Application

- High Speed Microprocessor
- High Frequency Digital Equipment
- ※ For using special purpose like Military, Medical, Aviation, Automobile device should be following a special specification.

LICC(Low Inductance chip capacitors)

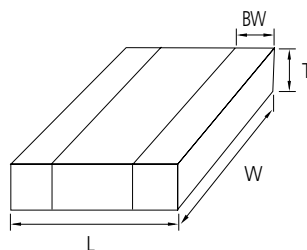

| Code | EIA Code | Dimension(mm) | | | |
|------|----------|-----------------|----------------|----------------------|-----------------|
| | | L | W | T | BW |
| L5 | 0204 | 0.52 ± 0.05 | 1.0 ± 0.05 | 0.3 ± 0.05 | 0.18 ± 0.08 |
| 01 | 0306 | 0.8 ± 0.15 | 1.6 ± 0.2 | $0.5 + 0.05 / - 0.1$ | $0.25 + 0.15$ |

SLIC(Super Low Inductance capacitors)

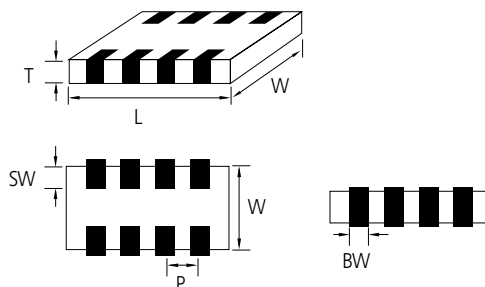

| Code | EIA Code | Dimension(mm) | | | | | |
|------|----------|---------------|----------------|----------------------|----------------|----------------|---------------|
| | | L | W | T | BW | SW | P |
| 10 | 0603 | 1.6 ± 0.1 | 0.8 ± 0.1 | $0.5 / + 0.05 - 0.1$ | 0.25 ± 0.1 | 0.15 ± 0.1 | 0.4 ± 0.1 |
| 21 | 0805 | 2.0 ± 0.1 | 1.25 ± 0.1 | $0.5 / + 0.05 - 0.1$ | 0.25 ± 0.1 | 0.18 ± 0.1 | 0.5 ± 0.1 |

Part Numbering System

General Capacitors

High Capacitance Capacitors

Super Small Size Capacitors

Medium-High Voltage Capacitors

Array Type Capacitors

Low ESL Capacitors

Reliability Test Condition

Premium Capacitors for Automotive Applications

Packaging Specification

Application Manual for Surface Mounting



Low ESL Capacitors Table (LICC)

| TC | Size(mm) | Tmax(mm) | Vr(V) | Capacitance (uF) | | | | | | | | | |
|-------------|------------|----------|-------|------------------|-------|-------|-----|------|------|---|-----|-----|----|
| | | | | 0.01 | 0.022 | 0.047 | 0.1 | 0.22 | 0.47 | 1 | 2.2 | 4.7 | 10 |
| X6S /X7S | 0204(0510) | 0.35 | 4 | X6S | | | | | | | | | |
| | | | 6.3 | X7S | | | | | | | | | |
| | 0306(0816) | 0.55 | 4 | X7S | | | | | | | | | |

| TC | Size(mm) | Tmax(mm) | Vr(V) | Capacitance (uF) | | | | | | | | | |
|-------------|------------|----------|-------|------------------|-------|-------|-----|------|------|---|-----|-----|----|
| | | | | 0.01 | 0.022 | 0.047 | 0.1 | 0.22 | 0.47 | 1 | 2.2 | 4.7 | 10 |
| X7R /X5R | 0306(0816) | 0.55 | 6.3 | X7R | | | | X5R | | | | | |
| | | | 0 | X7R | | | | | | | | | |
| | | | 16 | X7R | | | | | | | | | |
| | | | 25 | X7R | | | | | | | | | |
| | | | 50 | X7R | | | | | | | | | |

Low ESL Capacitors Table (SLIC)

| TC | Size(mm) | Tmax(mm) | Vr(V) | Capacitance (uF) | | | | | | | |
|---------------------|------------|----------|-------|------------------|------|------|---|-----|-----|----|----|
| | | | | 0.1 | 0.47 | 0.68 | 1 | 2.2 | 4.7 | 10 | 22 |
| X7R /X7S /X7T | 0603(1608) | 0.55 | 2.5 | | | | | | | | |
| | | | 4 | X7S | | | | | | | |
| | 0805(2012) | 0.55 | 4 | X7S | | | | | | | |
| | | | 6.3 | X7R | | | | | | | |
| | | | 16 | X7R | | | | | | | |

Product Lineup (Low ESL Capacitors-X7R, X6S, X7S)

| | Part Number | Size L×W (mm) | Capacitance | Rated Voltage (Vdc) | Capacitance Tolerance | Thickness Max. (mm) |
|---|------------------|---------------|-------------|---------------------|-----------------------|---------------------|
| 1 | CL21B104MO5NJN □ | 2.00×1.25 | 100nF | 16 | ±20% | 0.55 |
| 2 | CL21B684MO5NJN □ | | 680nF | 16 | ±20% | 0.55 |
| 3 | CL21B684MQ5NJN □ | | 680nF | 6.3 | ±20% | 0.55 |
| 1 | CLL5X224MR3NLN □ | 0.50×1.00 | 220nF | 4 | ±20% | 0.35 |
| 2 | CLL5X474MR3NLN □ | | 470nF | 4 | ±20% | 0.35 |
| 1 | CLL5Y104MQ3NLN □ | 0.50×1.00 | 100nF | 6.3 | ±20% | 0.35 |
| 2 | CL01Y105MR5NLN □ | 0.80×1.60 | 1μF | 4 | ±20% | 0.55 |
| 3 | CL01Y225MR5NLN □ | | 2.2μF | 4 | ±20% | 0.55 |
| 4 | CL10Y474MR5NJN □ | | 470nF | 4 | ±20% | 0.55 |
| 5 | CL10Y105MR5NJN □ | 1.60×0.80 | 1μF | 4 | ±20% | 0.55 |
| 6 | CL10Y225MR5NJN □ | | 2.2μF | 4 | ±20% | 0.55 |
| 7 | CL21Y105MR5NJN □ | 2.00×1.25 | 1μF | 4 | ±20% | 0.55 |
| 8 | CL21Y225MR5NJN □ | | 2.2μF | 4 | ±20% | 0.55 |

※ □mark means packaging code. If you want to learn the code or quantity in detail, please see p80.

Part Numbering System

General Capacitors

High Capacitance Capacitors

Super Small Size Capacitors

Medium-High Voltage Capacitors

Array Type Capacitors

Low ESL Capacitors

Reliability Test Condition



Premium Capacitors for Automotive Applications

Packaging Specification

Application Manual for Surface Mounting

Reliability Test Condition

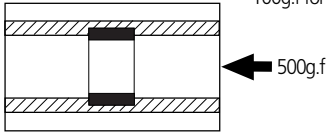
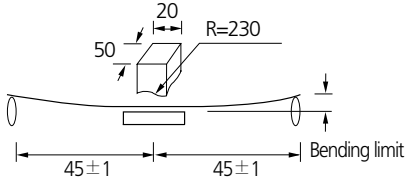
| No | Item | Performance | Test Condition | | |
|-----------------|-----------------------------------|--|--|-----------------------------------|---------------------------|
| 1 | Appearance | No abnormal exterior appearance | Visual Inspection through Microscope(× 10) | | |
| 2 | Insulation Resistance | 10,000MΩ min. or 500MΩ · μF min. (or *100MΩ · μF) product whichever is smaller (Rated voltage ≤ 16V: 10,000MΩ min. or 100MΩ · μF min. product whichever is smaller) | Apply the rated voltage for 60~ 120 sec. Rated voltage > 500V: Insulation Resistance shall be measured with 500 ± 50Vdc | | |
| 3 | Withstanding Voltage | No dielectric breakdown or mechanical breakdown | Apply the specified voltage* for 1~5 sec. Charge/Discharge current limit: 50mA max. *CLASS I (Rated Voltage < 100V): 300% of the rated Voltage CLASS II (Rated Voltage < 100V): 250% of the rated Voltage In the case of Vr ≥ 100V products, following condition should be applied. 100V ≤ Rated Voltage < 500V: 200% of the rated Voltage 500V ≤ Rated Voltage < 1000V: 150% of the rated Voltage Rated Voltage ≥ 1000V: 120% of the rated Voltage | | |
| 4 | Capacitance | CLASS I Within the specified tolerance | Capacitance | Frequency | Voltage 0.5 ~ 5 Vrms |
| | | | ≤ 1,000pF | 1MHz ± 10% | |
| | | CLASS II Within the specified tolerance | Capacitance | Frequency | Voltage 1.0 ± 0.2 Vrms |
| | | | > 1,000pF | 1KHz ± 10% | |
| Q | CLASS I | Capacitance ≥ 30pF : Q ≥ 1,000 < 30pF: Q ≥ 400 + 20 × C (C : Capacitance) | Capacitance | Frequency | Voltage 0.5 ~ 5 Vrms |
| | | | ≤ 1,000pF | 1MHz ± 10% | |
| | | | > 1,000pF | 1KHz ± 10% | |
| | | | Capacitance | Frequency | Voltage 1.0 ± 0.2 Vrms |
| ≤ 10μF | 1KHz ± 10% | | | | |
| 5 | Tanδ | CLASS II | 1. Characteristic: A(X5R) | | |
| | | | Rated Voltage | Spec | |
| | | | 50V / 35V | 0.025 max / 0.05 max* | |
| | | | 25V | 0.025 max / 0.05 max* | |
| | | | 16V | 0.035 max / 0.05 max* / 0.10 max* | |
| | | | ≤ 10V | 0.05 max / 0.10 max* | |
| | | | 2. Characteristic: B(X7R), X(X6S), Y(X7S) | | |
| | | | Rated Voltage | Spec | |
| | | | 50V ≥ / 35V / 25V | 0.025 max / 0.05 max* / 0.10 max* | |
| | | | 16V | 0.035 max / 0.10 max* | |
| | | | ≤ 10V | 0.05 max / 0.10 max* | |
| | | | 3. Characteristic: F(Y5V) | | |
| Rated Voltage | Spec | | | | |
| 50V / 35V / 25V | 0.05 max / 0.07 max* / 0.09 max* | | | | |
| 16V | 0.07 max / 0.09 max* / 0.125 max* | | | | |
| 10V | 0.125 max / 0.16 max* | | | | |
| ≤ 6.3V | 0.16 max | | | | |
| | | | You can check the specification at the web site or contact sales people for each product with mark* | | |

| No | Item | Performance | Test Condition | | | | | | | | | | | | | | | | | | |
|--|--|--|--|------------------------------------|-----------------------|------------------------------------|----------------------|------------------------------------|--|-----------|--------------------------------|-------------|----------------------------|-------|--------------------------|---|--------|---|--------------------------|---|--------|
| 6 | Temperature Characteristics of Capacitance | <table border="1"> <tr> <td colspan="2">CLASS I</td> </tr> <tr> <td>Characteristic</td> <td>Temp. Coefficient (PPM/°C)</td> </tr> <tr> <td>C</td> <td>0 ± 30</td> </tr> </table> | CLASS I | | Characteristic | Temp. Coefficient (PPM/°C) | C | 0 ± 30 | <p>Capacitance shall be measured by the steps shown in the following table.</p> <table border="1"> <tr> <th>Step</th> <th>Temperature(°C)</th> </tr> <tr> <td>1</td> <td>25 ± 2</td> </tr> <tr> <td>2</td> <td>Min. Operating Temp. ± 2</td> </tr> <tr> <td>3</td> <td>25 ± 2</td> </tr> <tr> <td>4</td> <td>Max. Operating Temp. ± 2</td> </tr> <tr> <td>5</td> <td>25 ± 2</td> </tr> </table> <p>(1) CLASS I Temperature Coefficient shall be calculated from the formula as below Temp. Coefficient = $\frac{C2 - C1}{C1 \times \Delta T} \times 10^6$ [ppm/°C] C1: Capacitance at step 3 C2: Capacitance at 125°C ΔT: 100°C (=125°C-25°C)</p> <p>(2) CLASS II Capacitance Change shall be calculated from the formula as below $\Delta C = \frac{C2 - C1}{C1} \times 100$ (%) C1: Capacitance at step 3 C2: Capacitance at step 2 or 4</p> | Step | Temperature(°C) | 1 | 25 ± 2 | 2 | Min. Operating Temp. ± 2 | 3 | 25 ± 2 | 4 | Max. Operating Temp. ± 2 | 5 | 25 ± 2 |
| | | CLASS I | | | | | | | | | | | | | | | | | | | |
| Characteristic | Temp. Coefficient (PPM/°C) | | | | | | | | | | | | | | | | | | | | |
| C | 0 ± 30 | | | | | | | | | | | | | | | | | | | | |
| Step | Temperature(°C) | | | | | | | | | | | | | | | | | | | | |
| 1 | 25 ± 2 | | | | | | | | | | | | | | | | | | | | |
| 2 | Min. Operating Temp. ± 2 | | | | | | | | | | | | | | | | | | | | |
| 3 | 25 ± 2 | | | | | | | | | | | | | | | | | | | | |
| 4 | Max. Operating Temp. ± 2 | | | | | | | | | | | | | | | | | | | | |
| 5 | 25 ± 2 | | | | | | | | | | | | | | | | | | | | |
| <table border="1"> <tr> <td colspan="2">CLASS II</td> </tr> <tr> <td>Characteristic</td> <td>Capacitance Change(%) with No bias</td> </tr> <tr> <td>A(X5R) / B(X7R)</td> <td>± 15%</td> </tr> <tr> <td>X(X6S), Y(X7S)</td> <td>± 22%</td> </tr> <tr> <td>F(Y5V)</td> <td>+22%~-82%</td> </tr> </table> | CLASS II | | Characteristic | Capacitance Change(%) with No bias | A(X5R) / B(X7R) | ± 15% | X(X6S), Y(X7S) | ± 22% | F(Y5V) | +22%~-82% | | | | | | | | | | | |
| CLASS II | | | | | | | | | | | | | | | | | | | | | |
| Characteristic | Capacitance Change(%) with No bias | | | | | | | | | | | | | | | | | | | | |
| A(X5R) / B(X7R) | ± 15% | | | | | | | | | | | | | | | | | | | | |
| X(X6S), Y(X7S) | ± 22% | | | | | | | | | | | | | | | | | | | | |
| F(Y5V) | +22%~-82% | | | | | | | | | | | | | | | | | | | | |
| 7 | Adhesive Strength of Termination | No indication of peeling shall occur on the terminal electrode | <p>Apply 500g.f* pressure for 10 ± 1 sec. *200g.f for 0201 *100g.f for 01005</p>  | | | | | | | | | | | | | | | | | | |
| 8 | Appearance | No indication of peeling shall occur | <ul style="list-style-type: none"> Bending Limit: 1mm Test Speed: 1.0mm/sec. Keep the test board at the limit point in 5 sec. Then Measure Capacitance  | | | | | | | | | | | | | | | | | | |
| | Capacitance | <table border="1"> <tr> <td colspan="2">CLASS I</td> <td>Capacitance Change</td> </tr> <tr> <td colspan="2"></td> <td>± 5% or ± 0.5 pF whichever is larger</td> </tr> <tr> <td rowspan="2">CLASS II</td> <td>A(X5R), B(X7R), X(X6S), Y(X7S)</td> <td>± 12.5%</td> </tr> <tr> <td>F(Y5V)</td> <td>± 30%</td> </tr> </table> | | CLASS I | | Capacitance Change | | | ± 5% or ± 0.5 pF whichever is larger | CLASS II | A(X5R), B(X7R), X(X6S), Y(X7S) | ± 12.5% | F(Y5V) | ± 30% | | | | | | | |
| CLASS I | | Capacitance Change | | | | | | | | | | | | | | | | | | | |
| | | ± 5% or ± 0.5 pF whichever is larger | | | | | | | | | | | | | | | | | | | |
| CLASS II | A(X5R), B(X7R), X(X6S), Y(X7S) | ± 12.5% | | | | | | | | | | | | | | | | | | | |
| | F(Y5V) | ± 30% | | | | | | | | | | | | | | | | | | | |
| 9 | Solderability | <p>More than 75% of the terminal surface is to be soldered newly, so metal part does not come out or dissolve</p>  | <table border="1"> <tr> <td>Solder</td> <td>Sn-3Ag-0.5Cu</td> </tr> <tr> <td>Solder Temp.</td> <td>245 ± 5°C</td> </tr> <tr> <td>Flux</td> <td>RMA Type</td> </tr> <tr> <td>Dip time</td> <td>3 ± 0.3 sec.</td> </tr> <tr> <td>Pre-heating</td> <td>at 80~120°C for 10~30 sec.</td> </tr> </table> | Solder | Sn-3Ag-0.5Cu | Solder Temp. | 245 ± 5°C | Flux | RMA Type | Dip time | 3 ± 0.3 sec. | Pre-heating | at 80~120°C for 10~30 sec. | | | | | | | | |
| Solder | Sn-3Ag-0.5Cu | | | | | | | | | | | | | | | | | | | | |
| Solder Temp. | 245 ± 5°C | | | | | | | | | | | | | | | | | | | | |
| Flux | RMA Type | | | | | | | | | | | | | | | | | | | | |
| Dip time | 3 ± 0.3 sec. | | | | | | | | | | | | | | | | | | | | |
| Pre-heating | at 80~120°C for 10~30 sec. | | | | | | | | | | | | | | | | | | | | |
| 10 | Appearance | No mechanical damage shall occur | <p>Solder temperature: 270 ± 5°C DIP TIME: 10 ± 1 sec. Each termination shall be fully immersed and preheated as below:</p> <table border="1"> <tr> <th>Step</th> <th>Temperature(°C)</th> <th>Time (sec.)</th> </tr> <tr> <td>1</td> <td>80~100</td> <td>60</td> </tr> <tr> <td>2</td> <td>150~180</td> <td>60</td> </tr> </table> <p>Leave the capacitor in ambient condition for specified time* before measurement *24 ± 2 hours(CLASS I) 24 ± 2 hours(CLASS II)</p> | Step | Temperature(°C) | Time (sec.) | 1 | 80~100 | 60 | 2 | 150~180 | 60 | | | | | | | | | |
| | Step | Temperature(°C) | | Time (sec.) | | | | | | | | | | | | | | | | | |
| | 1 | 80~100 | | 60 | | | | | | | | | | | | | | | | | |
| | 2 | 150~180 | | 60 | | | | | | | | | | | | | | | | | |
| | Capacitance | <table border="1"> <tr> <td colspan="2">CLASS I</td> <td>Capacitance Change</td> </tr> <tr> <td colspan="2"></td> <td>± 2.5% or ± 0.25 pF whichever is larger</td> </tr> <tr> <td rowspan="2">CLASS II</td> <td>A(X5R), B(X7R)</td> <td>± 7.5%</td> </tr> <tr> <td>X(X6S), Y(X7S)</td> <td>± 20%</td> </tr> </table> | | CLASS I | | Capacitance Change | | | ± 2.5% or ± 0.25 pF whichever is larger | CLASS II | A(X5R), B(X7R) | ± 7.5% | X(X6S), Y(X7S) | ± 20% | | | | | | | |
| | | CLASS I | | Capacitance Change | | | | | | | | | | | | | | | | | |
| | | ± 2.5% or ± 0.25 pF whichever is larger | | | | | | | | | | | | | | | | | | | |
| CLASS II | A(X5R), B(X7R) | ± 7.5% | | | | | | | | | | | | | | | | | | | |
| | X(X6S), Y(X7S) | ± 20% | | | | | | | | | | | | | | | | | | | |
| <table border="1"> <tr> <td>Q (CLASS I)</td> <td>Within the specified initial value</td> </tr> <tr> <td>Tanδ (CLASS II)</td> <td>Within the specified initial value</td> </tr> <tr> <td>Insulation resistance</td> <td>Within the specified initial value</td> </tr> <tr> <td>Withstanding voltage</td> <td>Within the specified initial value</td> </tr> </table> | Q (CLASS I) | Within the specified initial value | Tanδ (CLASS II) | Within the specified initial value | Insulation resistance | Within the specified initial value | Withstanding voltage | Within the specified initial value | | | | | | | | | | | | | |
| Q (CLASS I) | Within the specified initial value | | | | | | | | | | | | | | | | | | | | |
| Tanδ (CLASS II) | Within the specified initial value | | | | | | | | | | | | | | | | | | | | |
| Insulation resistance | Within the specified initial value | | | | | | | | | | | | | | | | | | | | |
| Withstanding voltage | Within the specified initial value | | | | | | | | | | | | | | | | | | | | |

Part Numbering System

General Capacitors

High Capacitance Capacitors

Super Small Size Capacitors

Medium-High Voltage Capacitors

Array Type Capacitors

Low ESL Capacitors

Reliability Test Condition

Premium Capacitors for Automotive Applications

Packaging Specification

Application Manual for Surface Mounting



| No | Item | Performance | Test Condition | | | |
|-------------------------|---|-------------|------------------------------------|---|--|--------------|
| 11 | Vibration Test | Appearance | No mechanical damage shall occur | <p>The capacitor shall be subjected to a harmonic motion having a total amplitude of 1.5mm changing frequency from 10Hz to 55Hz and back to 10Hz in about 1 min.</p> <p>Repeat this for 2hours each in 3 mutually perpendicular directions.</p> | | |
| | | Capacitance | Characteristic | | Capacitance Change | |
| | | | CLASS I | | $\pm 2.5\%$ or ± 0.25 pF whichever is larger | |
| | | | CLASS II | | A(X5R), B(X7R) | $\pm 5\%$ |
| | | | | | X(X6S), Y(X7S) | $\pm 10\%$ |
| | | F(Y5V) | | | $\pm 20\%$ | |
| | | Q (CLASS I) | Within the specified initial value | | | |
| Tan δ (CLASS II) | Within the specified initial value | | | | | |
| Insulation resistance | Within the specified initial value | | | | | |
| 12 | Moisture Resistance | Appearance | No mechanical damage shall occur | <p>Applied Voltage: rated voltage Temperature: $40 \pm 2^\circ\text{C}$ Humidity: 90~95% RH Duration Time: 500+12/0 Hr. Charge/Discharge Current: 50mA max.</p> <p>Perform the initial measurement according to Note1. Perform the final measurement according to Note2.</p> <p>This test is only applied to $V_r \leq 500\text{V}$ products. You can check the specification at the web site or contact sales people for each product with mark*</p> | | |
| | | Capacitance | Characteristic | | Capacitance Change | |
| | | | CLASS I | | $\pm 7.5\%$ or ± 0.75 pF whichever is larger | |
| | | | CLASS II | | A(X5R), B(X7R), X(X6S), Y(X7S) | $\pm 12.5\%$ |
| | | | | | F(Y5V) | $\pm 30\%$ |
| | | Q (CLASS I) | | | Capacitance $\geq 30\text{pF}$: $Q \geq 200$ $< 30\text{pF}$: $Q \geq 100 + 10/3 \times C$ (C: Capacitance) | |
| Tan δ (CLASS II) | 1.Capacitance: A(X5R) 0.05 max / 0.075 max* (35V / 50V) 0.05 max / 0.075 max* / 0.125 max* (16V / 25V) 0.075 max / 0.125 max* ($\leq 10\text{V}$) 2.Capacitance: B(X7R), X(X6S) 0.05 max / 0.125 max* (16V / 25V / 35V / 50V \geq) 0.075 max / 0.125 max* ($\leq 10\text{V}$) 3.Capacitance: F(Y5V) 0.09 max (50V) 0.09 max / 0.125 max* (25V / 35V) 0.09 max / 0.125 max* / 0.16 max* (16V) 0.16 max / 0.195 max* (10V) 0.195 max (4V / 6.3V) | | | | | |
| Insulation resistance | 500M Ω min. or 25M $\Omega \cdot \mu\text{F}$ min. product whichever is smaller / 12.5M $\Omega \cdot \mu\text{F}$ or over* | | | | | |
| 13 | High Temperature Resistance | Appearance | No mechanical damage shall occur | <p>Temperature : max. operating temperature</p> <p>Duration Time: 1000+48/0 Hr. Charge/Discharge Current: 50mA max.</p> <p>$V_r \leq 200\text{V}$: 200% of the rated Voltage $250\text{V} \leq V_r \leq 500\text{V}$: 150% of the rated Voltage $V_r = 630\text{V}$: 120% of the rated Voltage $1000\text{V} \leq V_r \leq 3000\text{V}$: 100% of the rated Voltage * : 150% or 100% of the rated Voltage</p> <p>Perform the initial measurement according to Note1 for class II Perform the final measurement according to Note2.</p> <p>You can check the specification at the web site or contact sales people for each product with mark*</p> | | |
| | | Capacitance | Characteristic | | Capacitance Change | |
| | | | CLASS I | | $\pm 3\%$ or ± 0.3 pF whichever is larger | |
| | | | CLASS II | | A(X5R), B(X7R), X(X6S), Y(X7S) | $\pm 12.5\%$ |
| | | | | | F(Y5V) | $\pm 30\%$ |
| | | Q (CLASS I) | | | Capacitance $\geq 30\text{pF}$: $Q \geq 350$ $10 \leq \text{Capacitance} < 30\text{pF}$: $Q \geq 275 + 2.5 \times C$ Capacitance $< 10\text{pF}$: $Q \geq 200 + 10 \times C$ (C: Capacitance) | |
| Tan δ (CLASS II) | 1.Capacitance: A(X5R) 0.05 max / 0.075 max* (35V / 50V) 0.05 max / 0.075 max* / 0.125 max* (16V / 25V) 0.075 max / 0.125 max* ($\leq 10\text{V}$) 2.Capacitance: B(X7R), X(X6S) 0.05 max / 0.125 max* (16V / 25V / 35V / 50V \geq) 0.075 max / 0.125 max* ($\leq 10\text{V}$) 3.Capacitance: F(Y5V) 0.09 max (50V) 0.09 max / 0.125 max* (25V / 35V) 0.09 max / 0.125 max* / 0.16 max* (16V) 0.16 max / 0.195 max* (10V) 0.195 max (4V / 6.3V) | | | | | |
| Insulation resistance | 1,000M Ω min. or 50M $\Omega \cdot \mu\text{F}$ min. product whichever is smaller / 25M $\Omega \cdot \mu\text{F}$ or over* | | | | | |

| No | Item | Performance | Test Condition | | | | | | | | | | | | | | | |
|-------------------------|------------------------------------|---|----------------------------------|--|-----------------|------------|---|----------------------------------|----|---|----|-----|---|----------------------------------|----|---|----|-----|
| 14 | Temperature Cycle | Appearance | No mechanical damage shall occur | | | | | | | | | | | | | | | |
| | | Capacitance | Characteristic | Capacitance Change | | | | | | | | | | | | | | |
| | | | CLASS I | $\pm 2.5\%$ or $\pm 0.25\text{pF}$ whichever is larger | | | | | | | | | | | | | | |
| | | | CLASS II | A(X5R), B(X7R) | $\pm 7.5\%$ | | | | | | | | | | | | | |
| | | | | X(X6S), Y(X7S) | $\pm 15\%$ | | | | | | | | | | | | | |
| | | F(Y5V) | | $\pm 20\%$ | | | | | | | | | | | | | | |
| Q (CLASS I) | Within the specified initial value | Capacitor shall be subjected to 5 cycles. Condition for 1 cycle: | | | | | | | | | | | | | | | | |
| Tan δ (CLASS II) | Within the specified initial value | | | | | | | | | | | | | | | | | |
| Insulation resistance | Within the specified initial value | | | | | | | | | | | | | | | | | |
| | | <table border="1"> <thead> <tr> <th>Step</th> <th>Temperature(°C)</th> <th>Time(min.)</th> </tr> </thead> <tbody> <tr> <td>1</td> <td>min. operating temperature +0/-3</td> <td>30</td> </tr> <tr> <td>2</td> <td>25</td> <td>2~3</td> </tr> <tr> <td>3</td> <td>max. operating temperature +0/-3</td> <td>30</td> </tr> <tr> <td>4</td> <td>25</td> <td>2~3</td> </tr> </tbody> </table> | | Step | Temperature(°C) | Time(min.) | 1 | min. operating temperature +0/-3 | 30 | 2 | 25 | 2~3 | 3 | max. operating temperature +0/-3 | 30 | 4 | 25 | 2~3 |
| Step | Temperature(°C) | Time(min.) | | | | | | | | | | | | | | | | |
| 1 | min. operating temperature +0/-3 | 30 | | | | | | | | | | | | | | | | |
| 2 | 25 | 2~3 | | | | | | | | | | | | | | | | |
| 3 | max. operating temperature +0/-3 | 30 | | | | | | | | | | | | | | | | |
| 4 | 25 | 2~3 | | | | | | | | | | | | | | | | |
| | | Leave the capacitor in ambient condition for specified time* before measurement *24 \pm 2 hours(CLASS I) 24 \pm 2 hours(CLASS II) | | | | | | | | | | | | | | | | |

| No | Recommended Soldering Method | | | | | | |
|-------------|---|------------------|-------------------------------|-------------------------|-----------|--------|---|
| 15 | Recommended Soldering Method By Size & Capacitance | Size inch(mm) | Temperature Characteristic | Capacitance | Condition | | |
| | | | | | Flow | Reflow | |
| | | 01005(0402) | - | - | - | - | ○ |
| | | 0201 (0603) | | | | | |
| | | 0402 (1005) | | | | | |
| | | 0603(1608) | Class I | - | ○ | ○ | |
| | | | Class II | $C < 1\mu\text{F}$ | ○ | ○ | |
| | | | | $C \geq 1\mu\text{F}$ | - | ○ | |
| | | 0805 (2012) | Class I | - | ○ | ○ | |
| | | | Class II | $C < 4.7\mu\text{F}$ | ○ | ○ | |
| | | | | $C \geq 4.7\mu\text{F}$ | - | ○ | |
| | | | Array | - | - | ○ | |
| | | 1206 (3216) | Class I | - | ○ | ○ | |
| | | | Class II | $C < 10\mu\text{F}$ | ○ | ○ | |
| | | | | $C \geq 10\mu\text{F}$ | - | ○ | |
| | Array | - | - | ○ | | | |
| 1210 (3225) | - | - | - | - | ○ | | |
| 1808 (4520) | | | | | ○ | | |
| 1812 (4532) | | | | | ○ | | |
| 2220 (5750) | | | | | ○ | | |
| | | | | | ○ | | |

Note1. Initial Measurement For Class II

Perform the heat treatment at 150°C+0/-10°C for 1 hour. Then Leave the capacitor in ambient condition for 24 \pm 2 hours before measurement. Then perform the measurement.

Note2. Latter Measurement

1. CLASS I

Leave the capacitor in ambient condition for 24 \pm 2 hours before measurement. Then perform the measurement.

2. CLASS II

Perform the heat treatment at 150°C+0/-10°C for 1 hour. Then Leave the capacitor in ambient condition for 24 \pm 2 hours before measurement. Then perform the measurement.

Note3. All Size in Reliability Test Condition Section is "inch"

Note4. Camera Strobe Circuit Capacitors Should be Following a Special Reliability Test Condition.

Please check with our sales representatives or product engineers.

Part Numbering System

General Capacitors

High Capacitance Capacitors

Super Small Size Capacitors

Medium-High Voltage Capacitors

Array Type Capacitors

Low ESL Capacitors

Reliability Test Condition

Premium Capacitors for Automotive Applications

Packaging Specification

Application Manual for Surface Mounting

S A M S U N G E L E C T R O - M E C H A N I C S





Premium Capacitors for Automotive Applications

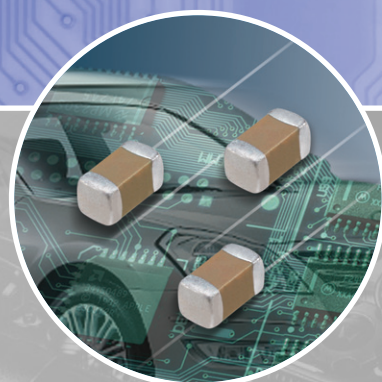

**SAMSUNG
ELECTRO-MECHANICS**

SAMSUNG

Premium Capacitors for Automotive Applications

Part Numbering System (Automotive Capacitors)

| | CL | 10 | B | 104 | K | B | 8 | 5 | P | N | C |
|---|-----------|-----------|----------|------------|----------|----------|----------|----------|----------|-----------|-----------|
| | 1 | 2 | 3 | 4 | 5 | 6 | 7 | 8 | 9 | 10 | 11 |
| 1. SERIES CODE _____ CL=Multi layer Ceramic Capacitors | | | | | | | | | | | |
| 2. SIZE CODE — inch (mm) _____ 05=1005(0402) 10=1608(0603) 21=2012(0805) 31=3216(1206) 32=3225(1210) | | | | | | | | | | | |
| 3. DIELECTRIC CODE _____ C=C0G (Class I) B=X7R (Class II) | | | | | | | | | | | |
| 4. CAPACITANCE CODE _____ Capacitance expressed in pF. 2 significant digits plus number of zeros. example) 106=10 × 10 ⁶ =10000000pF For Values < 10pF, Letter R denotes decimal point example) 1R5=1.5pF | | | | | | | | | | | |
| 5. TOLERANCE CODE _____ C=±0.25pF D=±0.5pF F=±1pF, ±1%* G=±2% J=±5% K=±10% M=±20% *For Values ≤10pF, F=±1pF, Values>10pF, F=±1% ※This code has only typical specifications. Please refer to individual specifications. | | | | | | | | | | | |
| 6. RATED VOLTAGE CODE _____ P=10V O=16V A=25V B=50V C=100V | | | | | | | | | | | |
| 7. THICKNESS CODE _____ 5 = 0.50mm 6= 0.60mm 8 = 0.80mm C = 0.85mm P = 1.15mm F = 1.25mm H = 1.60mm J = 2.50mm ※This code has only typical specifications. Please refer to individual specifications. | | | | | | | | | | | |
| 8. DESIGN CODE _____ 1=Ni/Cu/Ni Barrier/Sn 100%/Standard 4=Ni/Cu+Ag-Epoxy/Ni Barrier/Sn 100%/Standard 5=Ni/Cu+Ag-Epoxy/Ni Barrier/Sn 100%/Open Mode ※This code has only typical specifications. Please refer to individual specifications. | | | | | | | | | | | |
| 9. PRODUCT CODE _____ P=Automotive product meet AEC-Q-200. ※If orders are placed without returned specification, please allow us to judge that specification is accepted by your side. | | | | | | | | | | | |
| 10. GRADE CODE _____ N=Standard | | | | | | | | | | | |
| 11. PACKAGING CODE _____ B = Bulk O = Cardboard Tape, 10" Reel E = Embossed Type, 7" Reel P = Bulk Case D = Cardboard Tape, 13" Reel(10,000ea) F = Embossed Type, 13" Reel C = Cardboard Tape, 7" Reel L = Cardboard Tape, 13" Reel(15,000ea) S = Embossed Type, 10" Reel | | | | | | | | | | | |

This catalog has only typical specifications because there is no space for detailed specifications.
Please approve our product specifications or transact the approval sheet for product specifications before ordering.

★
Class I

| Symbol | EIA Code | Operation Temperature Range(°C) | Temperature Coefficient Range(ppm/°C) |
|--------|----------|---------------------------------|---------------------------------------|
| C | COG | -55 ~ +125 | 0 ±30 |

Class II

| Symbol | EIA Code | Operation Temperature Range(°C) | Capacitance Change (ΔC %) |
|--------|----------|---------------------------------|---------------------------|
| B | X7R | -55 ~ +125 | 0 ±15 |

★★
Capacitance Tolerance

| Code | Capacitance Tolerance | TC | Capacitance Step | Rated Capacitance |
|------|-----------------------|-----|------------------|-------------------|
| C | ± 0.25 pF | COG | Under 5 pF | E-12 series ★ |
| D | ± 0.5 pF | COG | 6.0 to 9.0 pF | E-12 series ★ |
| J | ± 5% | COG | Over 10 pF | E-12 series |
| K | ± 10% | X7R | Under 0.01 μF | E-3 series |
| | | | Over 0.01 μF | E-6 series |
| M | ± 20% | X7R | Under 0.01 μF | E-3 series |
| | | | Over 0.01 μF | E-6 series |

★E-24 series is also available

| Series | Capacitance Step | | | | | | | | | | | |
|--------|------------------|-----|-----|-----|-----|-----|-----|-----|-----|-----|-----|-----|
| | 1.0 | | | | 2.2 | | | | 4.7 | | | |
| E-3 | 1.0 | | | | 2.2 | | | | 4.7 | | | |
| E-6 | 1.0 | | 1.5 | | 2.2 | | 3.3 | | 4.7 | | 6.8 | |
| E-12 | 1.0 | 1.2 | 1.5 | 1.8 | 2.2 | 2.7 | 3.3 | 3.9 | 4.7 | 5.6 | 6.8 | 8.2 |
| E-24 | 1.0 | 1.1 | 1.2 | 1.3 | 2.2 | 2.4 | 2.7 | 3.0 | 4.7 | 5.1 | 5.6 | 6.2 |
| | 1.5 | 1.6 | 1.8 | 2.0 | 3.3 | 3.6 | 3.9 | 4.3 | 6.8 | 7.5 | 8.2 | 9.1 |

★★★

| Size | Code | Thickness(mm) | Spec(mm) ★ |
|------------|------|---------------|------------|
| 0402(1005) | 5 | 0.50 | ±0.05 |
| 0603(1608) | 8 | 0.80 | ±0.10 |
| 0805(2012) | 6 | 0.60 | ±0.10 |
| | C | 0.85 | ±0.10 |
| | F | 1.25 | ±0.10 |
| 1206(3216) | C | 0.85 | ±0.15 |
| | P | 1.15 | ±0.10 |
| | H | 1.60 | ±0.20 |

★The tolerance will be changed by Customer' standards and our new products. (High Capacitance)
Please check with our sales representatives or product engineers before ordering.

Part Numbering System

General Capacitors

High Capacitance Capacitors

Super Small Size Capacitors

Medium-High Voltage Capacitors

Array Type Capacitors

Low ESL Capacitors

Reliability Test Condition

Premium Capacitors for Automotive Applications

Packaging Specification

Application Manual for Surface Mounting

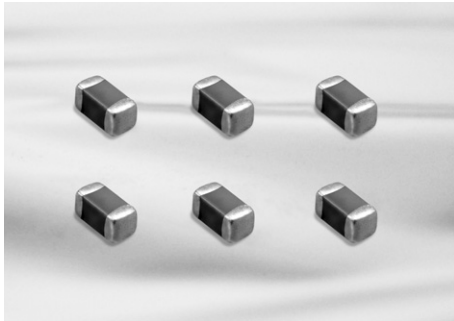

Feature

- Automotive products are manufactured in state of the art facilities recommended for registration to ISO/TS 16949:2002.
- Automotive products meet AEC-Q-200 requirements.
- Automotive products are RoHS compliant.
- Samsung terminations are suitable for all flow and reflow soldering systems. (10/21/31 size type only)
- Automotive products meet JEDEC-020-D requirements.
- COG dielectric components contain BME and copper terminations with a Ni/Sn plated overcoat.
- X7R dielectric components have BME and soft terminations with a Ni/Sn plated overcoat.

Application

- Automotive Electronic Equipment
(Powertrain, Safety, Body & Chassis, Convenience, Infotainment)

Structure and Dimensions

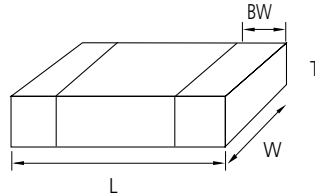

| Code | EIA Code | Dimension(mm) | | | |
|------|----------|---------------|-----------|-------------|---------------|
| | | L | W | T | BW |
| 05 | 0402 | 1.00±0.05 | 0.50±0.05 | 0.50(±0.05) | 0.2+0.15/-0.1 |
| 10 | 0603 | 1.60±0.10 | 0.80±0.10 | 0.80(±0.10) | 0.3±0.2 |
| 21 | 0805 | 2.00±0.10 | 1.25±0.10 | 0.60(±0.10) | 0.5±0.2/-0.3 |
| | | | | 0.85(±0.10) | |
| | | | | 1.25(±0.10) | |
| 31 | 1206 | 3.20±0.20 | 1.60±0.20 | 0.85(±0.15) | 0.5±0.3 |
| | | | | 1.15(±0.10) | |
| | | | | 1.60(±0.20) | |

Automotive Capacitors Table (COG, X7R)

| TC | Size(mm) | Vr | Capacitance (pF) | | | Capacitance (nF) | | | | | |
|-----|------------|-----|------------------|-----|-----|------------------|-----|-----|----|----|----|
| | | | 100 | 220 | 470 | 1 | 2.2 | 4.7 | 10 | 22 | 47 |
| COG | 0402(1005) | 50 | [Bar] | | | | | | | | |
| | | 100 | [Bar] | | | | | | | | |
| | 0603(1608) | 50 | [Bar] | | | | | | | | |
| | | 100 | [Bar] | | | | | | | | |
| | 0805(2012) | 50 | [Bar] | | | | | | | | |
| | | 100 | [Bar] | | | | | | | | |

| TC | Size(mm) | Thickness (mm) | Vr | Capacitance (nF) | | | | | Capacitance (uF) | | | | | |
|-----|------------|----------------|------|------------------|-------|-------|-----|-----|------------------|---|-----|-----|----|--|
| | | | | 10 | 22 | 47 | 100 | 220 | 470 | 1 | 2.2 | 4.7 | 10 | |
| X7R | 0603(1608) | 0.8 | 10 | [Bar] | | | | | | | | | | |
| | | 0.8 | 16 | [Bar] | | | | | | | | | | |
| | | 0.8 | 25 | [Bar] | | | | | | | | | | |
| | | 0.8 | 50 | [Bar] | | | | | | | | | | |
| | | 0.8 | 100 | [Bar] | | | | | | | | | | |
| | 0805(2012) | 1.25 | 10 | [Bar] | | | | | | | | | | |
| | | | 16 | [Bar] | | | | | | | | | | |
| | | | 25 | [Bar] | | | | | | | | | | |
| | | 0.6 | 25 | 10 | [Bar] | | | | | | | | | |
| | | | | 16 | [Bar] | | | | | | | | | |
| | | | | 25 | [Bar] | | | | | | | | | |
| | | | 0.85 | 50 | 10 | [Bar] | | | | | | | | |
| | | | | | 16 | [Bar] | | | | | | | | |
| | | | | | 25 | [Bar] | | | | | | | | |
| | | 1206(3216) | 1.6 | 10 | [Bar] | | | | | | | | | |
| | | | | 16 | [Bar] | | | | | | | | | |
| | | | | 25 | [Bar] | | | | | | | | | |
| | 0.85 | | 50 | 10 | [Bar] | | | | | | | | | |
| | | | | 16 | [Bar] | | | | | | | | | |

- Part Numbering System
- General Capacitors
- High Capacitance Capacitors
- Super Small Size Capacitors
- Medium-High Voltage Capacitors
- Array Type Capacitors
- Low ESL Capacitors
- Reliability Test Condition
- Premium Capacitors for Automotive Applications
- Packaging Specification
- Application Manual for Surface Mounting



Product Lineup (Automotive Capacitors_COG)

| | Part Number | Size L×W (mm) | Capacitance | Rated Voltage (Vdc) | Capacitance Tolerance | Thickness Max. (mm) |
|----|------------------|---------------|-------------|---------------------|-----------------------|---------------------|
| 1 | CL05C010CB51PN □ | 1.00×0.50 | 1.0pF | 50 | ±0.25pF | 0.55 |
| 2 | CL05C010CC51PN □ | | 1.0pF | 100 | ±0.25pF | 0.55 |
| 3 | CL05C1R5CB51PN □ | | 1.5pF | 50 | ±0.25pF | 0.55 |
| 4 | CL05C1R5CC51PN □ | | 1.5pF | 100 | ±0.25pF | 0.55 |
| 5 | CL05C2R2CB51PN □ | | 2.2pF | 50 | ±0.25pF | 0.55 |
| 6 | CL05C2R2CC51PN □ | | 2.2pF | 100 | ±0.25pF | 0.55 |
| 7 | CL05C3R3CB51PN □ | | 3.3pF | 50 | ±0.25pF | 0.55 |
| 8 | CL05C3R3CC51PN □ | | 3.3pF | 100 | ±0.25pF | 0.55 |
| 9 | CL05C4R7CB51PN □ | | 4.7pF | 50 | ±0.25pF | 0.55 |
| 10 | CL05C4R7CC51PN □ | | 4.7pF | 100 | ±0.25pF | 0.55 |
| 11 | CL05C6R8DB51PN □ | | 6.8pF | 50 | ±0.5pF | 0.55 |
| 12 | CL05C6R8DC51PN □ | | 6.8pF | 100 | ±0.5pF | 0.55 |
| 13 | CL05C100JB51PN □ | | 10pF | 50 | ±5% | 0.55 |
| 14 | CL05C100JC51PN □ | | 10pF | 100 | ±5% | 0.55 |
| 15 | CL05C120JB51PN □ | | 12pF | 50 | ±5% | 0.55 |
| 16 | CL05C120JC51PN □ | | 12pF | 100 | ±5% | 0.55 |
| 17 | CL05C150JB51PN □ | | 15pF | 50 | ±5% | 0.55 |
| 18 | CL05C150JC51PN □ | | 15pF | 100 | ±5% | 0.55 |
| 19 | CL05C180JB51PN □ | | 18pF | 50 | ±5% | 0.55 |
| 20 | CL05C180JC51PN □ | | 18pF | 100 | ±5% | 0.55 |
| 21 | CL05C220JB51PN □ | | 22pF | 50 | ±5% | 0.55 |
| 22 | CL05C220JC51PN □ | | 22pF | 100 | ±5% | 0.55 |
| 23 | CL05C270JB51PN □ | | 27pF | 50 | ±5% | 0.55 |
| 24 | CL05C270JC51PN □ | | 27pF | 100 | ±5% | 0.55 |
| 25 | CL05C330JB51PN □ | | 33pF | 50 | ±5% | 0.55 |
| 26 | CL05C330JC51PN □ | | 33pF | 100 | ±5% | 0.55 |
| 27 | CL05C390JB51PN □ | | 39pF | 50 | ±5% | 0.55 |
| 28 | CL05C390JC51PN □ | | 39pF | 100 | ±5% | 0.55 |
| 29 | CL05C470JB51PN □ | | 47pF | 50 | ±5% | 0.55 |
| 30 | CL05C470JC51PN □ | | 47pF | 100 | ±5% | 0.55 |
| 31 | CL05C560JB51PN □ | | 56pF | 50 | ±5% | 0.55 |
| 32 | CL05C560JC51PN □ | | 56pF | 100 | ±5% | 0.55 |
| 33 | CL05C680JB51PN □ | | 68pF | 50 | ±5% | 0.55 |
| 34 | CL05C680JC51PN □ | | 68pF | 100 | ±5% | 0.55 |
| 35 | CL05C820JB51PN □ | | 82pF | 50 | ±5% | 0.55 |
| 36 | CL05C820JC51PN □ | | 82pF | 100 | ±5% | 0.55 |
| 37 | CL05C101JB51PN □ | | 100pF | 50 | ±5% | 0.55 |
| 38 | CL05C101JC51PN □ | | 100pF | 100 | ±5% | 0.55 |
| 39 | CL05C121JB51PN □ | | 120pF | 50 | ±5% | 0.55 |
| 40 | CL05C151JB51PN □ | | 150pF | 50 | ±5% | 0.55 |
| 41 | CL05C221JB51PN □ | | 220pF | 50 | ±5% | 0.55 |
| 1 | CL10C010CB81PN □ | 1.60×0.80 | 1.0pF | 50 | ±0.25pF | 0.9 |
| 2 | CL10C010CC81PN □ | | 1.0pF | 100 | ±0.25pF | 0.9 |
| 3 | CL10C1R5CB81PN □ | | 1.5pF | 50 | ±0.25pF | 0.9 |
| 4 | CL10C1R5CC81PN □ | | 1.5pF | 100 | ±0.25pF | 0.9 |

※ □ mark means packaging code. If you want to learn the code or quantity in detail, please see p80.

Product Lineup (Automotive Capacitors_COG)

| | Part Number | Size L×W (mm) | Capacitance | Rated Voltage (Vdc) | Capacitance Tolerance | Thickness Max. (mm) |
|----|------------------|---------------|-------------|---------------------|-----------------------|---------------------|
| 5 | CL10C2R2CB81PN □ | 1.60×0.80 | 2.2pF | 50 | ±0.25pF | 0.9 |
| 6 | CL10C2R2CC81PN □ | | 2.2pF | 100 | ±0.25pF | 0.9 |
| 7 | CL10C3R3CB81PN □ | | 3.3pF | 50 | ±0.25pF | 0.9 |
| 8 | CL10C3R3CC81PN □ | | 3.3pF | 100 | ±0.25pF | 0.9 |
| 9 | CL10C4R7CB81PN □ | | 4.7pF | 50 | ±0.25pF | 0.9 |
| 10 | CL10C4R7CC81PN □ | | 4.7pF | 100 | ±0.25pF | 0.9 |
| 11 | CL10C6R8DB81PN □ | | 6.8pF | 50 | ±0.5pF | 0.9 |
| 12 | CL10C6R8DC81PN □ | | 6.8pF | 100 | ±0.5pF | 0.9 |
| 13 | CL10C100JB81PN □ | | 10pF | 50 | ±5% | 0.9 |
| 14 | CL10C100JC81PN □ | | 10pF | 100 | ±5% | 0.9 |
| 15 | CL10C120JB81PN □ | | 12pF | 50 | ±5% | 0.9 |
| 16 | CL10C120JC81PN □ | | 12pF | 100 | ±5% | 0.9 |
| 17 | CL10C150JB81PN □ | | 15pF | 50 | ±5% | 0.9 |
| 18 | CL10C150JC81PN □ | | 15pF | 100 | ±5% | 0.9 |
| 19 | CL10C180JB81PN □ | | 18pF | 50 | ±5% | 0.9 |
| 20 | CL10C180JC81PN □ | | 18pF | 100 | ±5% | 0.9 |
| 21 | CL10C220JB81PN □ | | 22pF | 50 | ±5% | 0.9 |
| 22 | CL10C220JC81PN □ | | 22pF | 100 | ±5% | 0.9 |
| 23 | CL10C270JB81PN □ | | 27pF | 50 | ±5% | 0.9 |
| 24 | CL10C270JC81PN □ | | 27pF | 100 | ±5% | 0.9 |
| 25 | CL10C330JB81PN □ | | 33pF | 50 | ±5% | 0.9 |
| 26 | CL10C330JC81PN □ | | 33pF | 100 | ±5% | 0.9 |
| 27 | CL10C390JB81PN □ | | 39pF | 50 | ±5% | 0.9 |
| 28 | CL10C390JC81PN □ | | 39pF | 100 | ±5% | 0.9 |
| 29 | CL10C470JB81PN □ | | 47pF | 50 | ±5% | 0.9 |
| 30 | CL10C470JC81PN □ | | 47pF | 100 | ±5% | 0.9 |
| 31 | CL10C560JB81PN □ | | 56pF | 50 | ±5% | 0.9 |
| 32 | CL10C560JC81PN □ | | 56pF | 100 | ±5% | 0.9 |
| 33 | CL10C680JB81PN □ | | 68pF | 50 | ±5% | 0.9 |
| 34 | CL10C680JC81PN □ | | 68pF | 100 | ±5% | 0.9 |
| 35 | CL10C820JB81PN □ | | 82pF | 50 | ±5% | 0.9 |
| 36 | CL10C820JC81PN □ | | 82pF | 100 | ±5% | 0.9 |
| 37 | CL10C101JB81PN □ | | 100pF | 50 | ±5% | 0.9 |
| 38 | CL10C101JC81PN □ | | 100pF | 100 | ±5% | 0.9 |
| 39 | CL10C121JB81PN □ | | 120pF | 50 | ±5% | 0.9 |
| 40 | CL10C151JB81PN □ | | 150pF | 50 | ±5% | 0.9 |
| 41 | CL10C221JB81PN □ | | 220pF | 50 | ±5% | 0.9 |
| 42 | CL10C271JB81PN □ | | 270pF | 50 | ±5% | 0.9 |
| 43 | CL10C331JB81PN □ | | 330pF | 50 | ±5% | 0.9 |
| 44 | CL10C391JB81PN □ | | 390pF | 50 | ±5% | 0.9 |
| 45 | CL10C471JB81PN □ | | 470pF | 50 | ±5% | 0.9 |
| 46 | CL10C561JB81PN □ | | 560pF | 50 | ±5% | 0.9 |
| 47 | CL10C681JB81PN □ | | 680pF | 50 | ±5% | 0.9 |
| 48 | CL10C821JB81PN □ | | 820pF | 50 | ±5% | 0.9 |
| 49 | CL10C102JB81PN □ | | 1000pF | 50 | ±5% | 0.9 |

※ □ mark means packaging code. If you want to learn the code or quantity in detail, please see p80.

- Part Numbering System
- General Capacitors
- High Capacitance Capacitors
- Super Small Size Capacitors
- Medium-High Voltage Capacitors
- Array Type Capacitors
- Low ESL Capacitors
- Reliability Test Condition
- Premium Capacitors for Automotive Applications
- Packaging Specification
- Application Manual for Surface Mounting



Product Lineup (Automotive Capacitors_COG)

| | Part Number | Size L×W (mm) | Capacitance | Rated Voltage (Vdc) | Capacitance Tolerance | Thickness Max. (mm) |
|----|------------------|------------------|-------------|---------------------------|--------------------------|------------------------|
| 1 | CL21C100JB61PN □ | 2.00×1.25 | 10pF | 50 | ±5% | 0.7 |
| 2 | CL21C100JC61PN □ | | 10pF | 100 | ±5% | 0.7 |
| 3 | CL21C120JB61PN □ | | 12pF | 50 | ±5% | 0.7 |
| 4 | CL21C120JC61PN □ | | 12pF | 100 | ±5% | 0.7 |
| 5 | CL21C150JB61PN □ | | 15pF | 50 | ±5% | 0.7 |
| 6 | CL21C150JC61PN □ | | 15pF | 100 | ±5% | 0.7 |
| 7 | CL21C180JB61PN □ | | 18pF | 50 | ±5% | 0.7 |
| 8 | CL21C180JC61PN □ | | 18pF | 100 | ±5% | 0.7 |
| 9 | CL21C220JB61PN □ | | 22pF | 50 | ±5% | 0.7 |
| 10 | CL21C220JC61PN □ | | 22pF | 100 | ±5% | 0.7 |
| 11 | CL21C270JC61PN □ | | 27pF | 100 | ±5% | 0.7 |
| 12 | CL21C330JB61PN □ | | 33pF | 50 | ±5% | 0.7 |
| 13 | CL21C330JC61PN □ | | 33pF | 100 | ±5% | 0.7 |
| 14 | CL21C390JB61PN □ | | 39pF | 50 | ±5% | 0.7 |
| 15 | CL21C390JC61PN □ | | 39pF | 100 | ±5% | 0.7 |
| 16 | CL21C470JB61PN □ | | 47pF | 50 | ±5% | 0.7 |
| 17 | CL21C470JC61PN □ | | 47pF | 100 | ±5% | 0.7 |
| 18 | CL21C560JB61PN □ | | 56pF | 50 | ±5% | 0.7 |
| 19 | CL21C560JC61PN □ | | 56pF | 100 | ±5% | 0.7 |
| 20 | CL21C680JB61PN □ | | 68pF | 50 | ±5% | 0.7 |
| 21 | CL21C680JC61PN □ | | 68pF | 100 | ±5% | 0.7 |
| 22 | CL21C820JB61PN □ | | 82pF | 50 | ±5% | 0.7 |
| 23 | CL21C820JC61PN □ | | 82pF | 100 | ±5% | 0.7 |
| 24 | CL21C101JB61PN □ | | 100pF | 50 | ±5% | 0.7 |
| 25 | CL21C101JC61PN □ | | 100pF | 100 | ±5% | 0.7 |
| 26 | CL21C121JB61PN □ | | 120pF | 50 | ±5% | 0.7 |
| 27 | CL21C121JC61PN □ | | 120pF | 100 | ±5% | 0.7 |
| 28 | CL21C151JB61PN □ | | 150pF | 50 | ±5% | 0.7 |
| 29 | CL21C151JC61PN □ | | 150pF | 100 | ±5% | 0.7 |
| 30 | CL21C221JB61PN □ | | 220pF | 50 | ±5% | 0.7 |
| 31 | CL21C221JC61PN □ | | 220pF | 100 | ±5% | 0.7 |
| 32 | CL21C271JB61PN □ | | 270pF | 50 | ±5% | 0.7 |
| 33 | CL21C271JC61PN □ | | 270pF | 100 | ±5% | 0.7 |
| 34 | CL21C331JB61PN □ | | 330pF | 50 | ±5% | 0.7 |

※ □ mark means packaging code. If you want to learn the code or quantity in detail, please see p80.

Product Lineup (Automotive Capacitors_COG)

| | Part Number | Size L×W (mm) | Capacitance | Rated Voltage (Vdc) | Capacitance Tolerance | Thickness Max. (mm) |
|----|------------------|---------------|-------------|---------------------|-----------------------|---------------------|
| 35 | CL21C331JC61PN □ | 2.00×1.25 | 330pF | 100 | ±5% | 0.7 |
| 36 | CL21C471JBC1PN □ | | 470pF | 50 | ±5% | 0.95 |
| 37 | CL21C471JCC1PN □ | | 470pF | 100 | ±5% | 0.95 |
| 38 | CL21C561JBC1PN □ | | 560pF | 50 | ±5% | 0.95 |
| 39 | CL21C561JCC1PN □ | | 560pF | 100 | ±5% | 0.95 |
| 40 | CL21C681JBC1PN □ | | 680pF | 50 | ±5% | 0.95 |
| 41 | CL21C681JCC1PN □ | | 680pF | 100 | ±5% | 0.95 |
| 42 | CL21C821JBC1PN □ | | 820pF | 50 | ±5% | 0.95 |
| 43 | CL21C821JCC1PN □ | | 820pF | 100 | ±5% | 0.95 |
| 44 | CL21C102JBC1PN □ | | 1000pF | 50 | ±5% | 0.95 |
| 45 | CL21C102JCC1PN □ | | 1000pF | 100 | ±5% | 0.95 |
| 46 | CL21C102JCF1PN □ | | 1000pF | 100 | ±5% | 1.35 |
| 47 | CL21C122JBC1PN □ | | 1200pF | 50 | ±5% | 0.95 |
| 48 | CL21C152JBC1PN □ | | 1500pF | 50 | ±5% | 0.95 |
| 49 | CL21C182JBC1PN □ | | 1800pF | 50 | ±5% | 0.95 |
| 50 | CL21C222JBC1PN □ | | 2200pF | 50 | ±5% | 0.95 |
| 51 | CL21C272JBC1PN □ | | 2700pF | 50 | ±5% | 0.95 |
| 52 | CL21C332JBC1PN □ | | 3300pF | 50 | ±5% | 0.95 |
| 53 | CL21C392JBC1PN □ | | 3900pF | 50 | ±5% | 0.95 |
| 54 | CL21C472JBC1PN □ | | 4700pF | 50 | ±5% | 0.95 |
| 55 | CL21C562JBC1PN □ | | 5600pF | 50 | ±5% | 0.95 |
| 56 | CL21C102JBF1PN □ | | 1000pF | 50 | ±5% | 1.35 |
| 57 | CL21C122JBF1PN □ | | 1200pF | 50 | ±5% | 1.35 |
| 58 | CL21C152JBF1PN □ | | 1500pF | 50 | ±5% | 1.35 |
| 59 | CL21C182JBF1PN □ | | 1800pF | 50 | ±5% | 1.35 |
| 60 | CL21C222JBF1PN □ | | 2200pF | 50 | ±5% | 1.35 |
| 61 | CL21C272JBF1PN □ | | 2700pF | 50 | ±5% | 1.35 |
| 62 | CL21C332JBF1PN □ | | 3300pF | 50 | ±5% | 1.35 |
| 63 | CL21C392JBF1PN □ | | 3900pF | 50 | ±5% | 1.35 |
| 64 | CL21C472JBF1PN □ | | 4700pF | 50 | ±5% | 1.35 |
| 65 | CL21C562JBF1PN □ | | 5600pF | 50 | ±5% | 1.35 |
| 66 | CL21C682JBF1PN □ | | 6800pF | 50 | ±5% | 1.35 |
| 67 | CL21C822JBF1PN □ | 8200pF | 50 | ±5% | 1.35 | |
| 68 | CL21C103JBF1PN □ | 10000pF | 50 | ±5% | 1.35 | |

※ □ mark means packaging code. If you want to learn the code or quantity in detail, please see p80.

- Part Numbering System
- General Capacitors
- High Capacitance Capacitors
- Super Small Size Capacitors
- Medium-High Voltage Capacitors
- Array Type Capacitors
- Low ESL Capacitors
- Reliability Test Condition
- Premium Capacitors for Automotive Applications
- Packaging Specification
- Application Manual for Surface Mounting



Product Lineup (Automotive Capacitors_X7R)

| | Part Number | Size L×W (mm) | Capacitance | Rated Voltage (Vdc) | Capacitance Tolerance | Thickness Max. (mm) |
|----|------------------|---------------|-------------|---------------------|-----------------------|---------------------|
| 1 | CL10B221KC85PN □ | 1.60×0.80 | 0.22nF | 100 | ±10% | 0.90 |
| 2 | CL10B471KC85PN □ | | 0.47nF | 100 | ±10% | 0.90 |
| 3 | CL10B102KB85PN □ | | 1.0nF | 50 | ±10% | 0.90 |
| 4 | CL10B102KC85PN □ | | 1.0nF | 100 | ±10% | 0.90 |
| 5 | CL10B222KB85PN □ | | 2.2nF | 50 | ±10% | 0.90 |
| 6 | CL10B222KC85PN □ | | 2.2nF | 100 | ±10% | 0.90 |
| 7 | CL10B472KB85PN □ | | 4.7nF | 50 | ±10% | 0.90 |
| 8 | CL10B472KC85PN □ | | 4.7nF | 100 | ±10% | 0.90 |
| 9 | CL10B103KA85PN □ | | 10nF | 25 | ±10% | 0.90 |
| 10 | CL10B103KB85PN □ | | 10nF | 50 | ±10% | 0.90 |
| 11 | CL10B103KC85PN □ | | 10nF | 100 | ±10% | 0.90 |
| 12 | CL10B153KA85PN □ | | 15nF | 25 | ±10% | 0.90 |
| 13 | CL10B153KB85PN □ | | 15nF | 50 | ±10% | 0.90 |
| 14 | CL10B223KA85PN □ | | 22nF | 25 | ±10% | 0.90 |
| 15 | CL10B223KB85PN □ | | 22nF | 50 | ±10% | 0.90 |
| 16 | CL10B333KA85PN □ | | 33nF | 25 | ±10% | 0.90 |
| 17 | CL10B333KB85PN □ | | 33nF | 50 | ±10% | 0.90 |
| 18 | CL10B473KO85PN □ | | 47nF | 16 | ±10% | 0.90 |
| 19 | CL10B473KA85PN □ | | 47nF | 25 | ±10% | 0.90 |
| 20 | CL10B473KB85PN □ | | 47nF | 50 | ±10% | 0.90 |
| 21 | CL10B683KO85PN □ | | 68nF | 16 | ±10% | 0.90 |
| 22 | CL10B683KA85PN □ | | 68nF | 25 | ±10% | 0.90 |
| 23 | CL10B683KB85PN □ | | 68nF | 50 | ±10% | 0.90 |
| 24 | CL10B104KO85PN □ | | 100nF | 16 | ±10% | 0.90 |
| 25 | CL10B104KA85PN □ | | 100nF | 25 | ±10% | 0.90 |
| 26 | CL10B104KB85PN □ | | 100nF | 50 | ±10% | 0.90 |
| 27 | CL10B154KO84PN □ | | 150nF | 16 | ±10% | 0.90 |
| 28 | CL10B154KA84PN □ | | 150nF | 25 | ±10% | 0.90 |
| 29 | CL10B224KO84PN □ | | 220nF | 16 | ±10% | 0.90 |
| 30 | CL10B224KA84PN □ | | 220nF | 25 | ±10% | 0.90 |
| 31 | CL10B334KO84PN □ | | 330nF | 16 | ±10% | 0.90 |
| 32 | CL10B334KA84PN □ | | 330nF | 25 | ±10% | 0.90 |
| 33 | CL10B474KO84PN □ | | 470nF | 16 | ±10% | 0.90 |
| 34 | CL10B474KA84PN □ | | 470nF | 25 | ±10% | 0.90 |
| 1 | CL21B102KB65PN □ | 2.00×1.25 | 1.0nF | 50 | ±10% | 0.70 |
| 2 | CL21B102KC65PN □ | | 1.0nF | 100 | ±10% | 0.70 |
| 3 | CL21B222KB65PN □ | | 2.2nF | 50 | ±10% | 0.70 |
| 4 | CL21B222KC65PN □ | | 2.2nF | 100 | ±10% | 0.70 |
| 5 | CL21B472KB65PN □ | | 4.7nF | 50 | ±10% | 0.70 |
| 6 | CL21B472KC65PN □ | | 4.7nF | 100 | ±10% | 0.70 |
| 7 | CL21B103KB65PN □ | | 10nF | 50 | ±10% | 0.70 |
| 8 | CL21B103KC65PN □ | | 10nF | 100 | ±10% | 0.70 |
| 9 | CL21B153KB65PN □ | | 15nF | 50 | ±10% | 0.70 |
| 10 | CL21B153KC65PN □ | | 15nF | 100 | ±10% | 0.70 |
| 11 | CL21B223KB65PN □ | | 22nF | 50 | ±10% | 0.70 |
| 12 | CL21B223KC65PN □ | | 22nF | 100 | ±10% | 0.70 |
| 13 | CL21B333KBC5PN □ | | 33nF | 50 | ±10% | 0.95 |
| 14 | CL21B333KCC5PN □ | | 33nF | 100 | ±10% | 0.95 |

※ □ mark means packaging code. If you want to learn the code or quantity in detail, please see p80.

Product Lineup (Automotive Capacitors_X7R)

| | Part Number | Size L×W (mm) | Capacitance | Rated Voltage (Vdc) | Capacitance Tolerance | Thickness Max. (mm) |
|----|------------------|---------------|-------------|---------------------|-----------------------|---------------------|
| 15 | CL21B473KAC5PN □ | 2.00×1.25 | 47nF | 25 | ±10% | 0.95 |
| 16 | CL21B473KBC5PN □ | | 47nF | 50 | ±10% | 0.95 |
| 17 | CL21B473KCC5PN □ | | 47nF | 100 | ±10% | 0.95 |
| 18 | CL21B683KAC5PN □ | | 68nF | 25 | ±10% | 0.95 |
| 19 | CL21B683KBC5PN □ | | 68nF | 50 | ±10% | 0.95 |
| 20 | CL21B683KCC5PN □ | | 68nF | 100 | ±10% | 0.95 |
| 21 | CL21B104KOC5PN □ | | 100nF | 16 | ±10% | 0.95 |
| 22 | CL21B104KAC5PN □ | | 100nF | 25 | ±10% | 0.95 |
| 23 | CL21B104KBC5PN □ | | 100nF | 50 | ±10% | 0.95 |
| 24 | CL21B104KBF5PN □ | | 100nF | 50 | ±10% | 1.35 |
| 25 | CL21B104KCC5PN □ | | 100nF | 100 | ±10% | 0.95 |
| 26 | CL21B104KCF5PN □ | | 100nF | 100 | ±10% | 1.35 |
| 27 | CL21B154KOF4PN □ | | 150nF | 16 | ±10% | 1.35 |
| 28 | CL21B154KAF4PN □ | | 150nF | 25 | ±10% | 1.35 |
| 29 | CL21B154KBF4PN □ | | 150nF | 50 | ±10% | 1.35 |
| 30 | CL21B224KOF4PN □ | | 220nF | 16 | ±10% | 1.35 |
| 31 | CL21B224KAF4PN □ | | 220nF | 25 | ±10% | 1.35 |
| 32 | CL21B224KBF4PN □ | | 220nF | 50 | ±10% | 1.35 |
| 33 | CL21B334KOF4PN □ | | 330nF | 16 | ±10% | 1.35 |
| 34 | CL21B334KAF4PN □ | | 330nF | 25 | ±10% | 1.35 |
| 35 | CL21B334KBF4PN □ | | 330nF | 50 | ±10% | 1.35 |
| 36 | CL21B474KOF4PN □ | | 470nF | 16 | ±10% | 1.35 |
| 37 | CL21B474KAF4PN □ | | 470nF | 25 | ±10% | 1.35 |
| 38 | CL21B474KBF4PN □ | | 470nF | 50 | ±10% | 1.35 |
| 39 | CL21B684KOF4PN □ | | 680nF | 16 | ±10% | 1.35 |
| 40 | CL21B684KAF4PN □ | | 680nF | 25 | ±10% | 1.35 |
| 41 | CL21B105KOF4PN □ | | 1μF | 16 | ±10% | 1.35 |
| 42 | CL21B105KAF4PN □ | | 1μF | 25 | ±10% | 1.35 |
| 1 | CL31B104KBC5PN □ | 3.20×1.60 | 100nF | 50 | ±10% | 1.00 |
| 2 | CL31B154KBP5PN □ | | 150nF | 50 | ±10% | 1.25 |
| 3 | CL31B224KAC5PN □ | | 220nF | 25 | ±10% | 1.00 |
| 4 | CL31B224KBP5PN □ | | 220nF | 50 | ±10% | 1.25 |
| 5 | CL31B334KAC5PN □ | | 330nF | 25 | ±10% | 1.00 |
| 6 | CL31B334KBH5PN □ | | 330nF | 50 | ±10% | 1.80 |
| 7 | CL31B474KAC5PN □ | | 470nF | 25 | ±10% | 1.00 |
| 8 | CL31B474KBH5PN □ | | 470nF | 50 | ±10% | 1.80 |
| 9 | CL31B684KAP5PN □ | | 680nF | 25 | ±10% | 1.25 |
| 10 | CL31B684KBH5PN □ | | 680nF | 50 | ±10% | 1.80 |
| 11 | CL31B105KOP5PN □ | | 1μF | 16 | ±10% | 1.25 |
| 12 | CL31B105KAP5PN □ | | 1μF | 25 | ±10% | 1.25 |
| 13 | CL31B105KBH5PN □ | | 1μF | 50 | ±10% | 1.80 |
| 14 | CL31B155KOH4PN □ | | 1.5μF | 16 | ±10% | 1.80 |
| 15 | CL31B155KAH4PN □ | | 1.5μF | 25 | ±10% | 1.80 |
| 16 | CL31B155KBH4PN □ | | 1.5μF | 50 | ±10% | 1.80 |
| 17 | CL31B225KOH4PN □ | | 2.2μF | 16 | ±10% | 1.80 |
| 18 | CL31B225KAH4PN □ | | 2.2μF | 25 | ±10% | 1.80 |
| 19 | CL31B225KBH4PN □ | | 2.2μF | 50 | ±10% | 1.80 |

※ □mark means packaging code. If you want to learn the code or quantity in detail, please see p80.

- Part Numbering System
- General Capacitors
- High Capacitance Capacitors
- Super Small Size Capacitors
- Medium-High Voltage Capacitors
- Array Type Capacitors
- Low ESL Capacitors
- Reliability Test Condition
- Premium Capacitors for Automotive Applications
- Packaging Specification
- Application Manual for Surface Mounting



Reliability Test Condition (Automotive Capacitors)

| No | Item | Performance | Test Condition | |
|----|-------------------------------------|--|---------------------------------|--|
| 1 | Pre-and Post-Stress Electrical Test | - | | |
| 2 | High Temperature Exposure | Appearance | No abnormal exterior appearance | |
| | | Capacitance Change | CLASS I | Within $\pm 2.5\%$ or $0.25\mu\text{F}$, (Whichever is larger) |
| | | | CLASS II | Within $\pm 10\%$ |
| | | Q | CLASS I | Capacitance $\geq 30\mu\text{F}$: $Q \geq 1,000$ $< 30\mu\text{F}$: $Q \geq 400 + 20 \times C$ (C : Capacitance) |
| | | Tan δ | CLASS II | Rated Voltage $\geq 25\text{V}$: 0.03 max $\geq 16\text{V}$: 0.05 max $\geq 10\text{V}$: 0.075 max |
| IR | | More than $10,000 \text{M}\Omega$ or $500 \text{M}\Omega \times \mu\text{F}$ (Whichever is smaller) | | |
| 3 | Temperature Cycling | Appearance | No abnormal exterior appearance | |
| | | Capacitance Change | CLASS I | Within $\pm 2.5\%$ or $0.25\mu\text{F}$, (Whichever is larger) |
| | | | CLASS II | Within $\pm 10\%$ |
| | | Q | CLASS I | Capacitance $\geq 30\mu\text{F}$: $Q \geq 1,000$ $< 30\mu\text{F}$: $Q \geq 400 + 20 \times C$ (C : Capacitance) |
| | | Tan δ | CLASS II | Rated Voltage $\geq 25\text{V}$: 0.03 max $\geq 16\text{V}$: 0.05 max $\geq 10\text{V}$: 0.075 max |
| IR | | More than $10,000 \text{M}\Omega$ or $500 \text{M}\Omega \times \mu\text{F}$ (Whichever is smaller) | | |
| 4 | Destructive Physical Analysis | No defects or abnormalities | Per EIA 469 | |
| 5 | Moisture Resistance | Appearance | No abnormal exterior appearance | |
| | | Capacitance Change | CLASS I | Within $\pm 2.5\%$ or $0.25\mu\text{F}$, (Whichever is larger) |
| | | | CLASS II | Within $\pm 12.5\%$ |
| | | Q | CLASS I | Capacitance $\geq 30\mu\text{F}$: $Q \geq 350$ $< 10\mu\text{F}$: $Q \geq 275 + (5/2) \times C$ $< 10\mu\text{F}$: $Q \geq 200 + 10 \times C$ (C : Capacitance) |
| | | Tan δ | CLASS II | Rated Voltage $\geq 25\text{V}$: 0.03 max $\geq 16\text{V}$: 0.05 max $\geq 10\text{V}$: 0.075 max |
| IR | | More than $10,000 \text{M}\Omega$ or $500 \text{M}\Omega \times \mu\text{F}$ (Whichever is smaller) | | |

| Step | Temperature(°C) | Time(min.) |
|------|------------------------------|------------|
| 1 | Min. operating Temp. ± 2 | 15 ± 3 |
| 2 | 25 ± 2 | 1 |
| 3 | Max. operating Temp. ± 2 | 15 ± 3 |
| 4 | 25 ± 2 | 1 |

The graph shows a temperature cycle over 24 hours. The y-axis is temperature in degrees Celsius (0 to 80), and the x-axis is time in hours (0 to 24). The cycle consists of four trapezoidal pulses. Each pulse starts at 25°C, ramps up to 65°C, holds at 65°C for 2 hours, and then ramps back down to 25°C. The humidity is 90-100% RH during the heating and cooling phases, and 80-100% RH during the 2-hour hold at 65°C. The test is repeated 10 times over the 24-hour period.

* For the more detail Specification, Please refer to the Samsung MLCC catalogue.

| No | Item | Performance | Test Condition | | | | | | |
|-----------|---------------------------------|--|--|--|----------|------|--------|-------|-----------|
| 6 | Biased Humidity | Appearance | No abnormal exterior appearance | | | | | | |
| | | Capacitance Change | CLASS I | Within $\pm 2.5\%$ or $0.25\mu\text{F}$, (Whichever is larger) | | | | | |
| | | | CLASS II | Within $\pm 12.5\%$ | | | | | |
| | | Q | CLASS I | Capacitance $\geq 30\mu\text{F}$: $Q \geq 200$ $< 30\mu\text{F}$: $Q \geq 100 + (10/3) \times C$ (C : Capacitance) | | | | | |
| | | Tan δ | CLASS II | Rated Voltage $\geq 25\text{V}$: 0.035 max $\geq 16\text{V}$: 0.05 max $\geq 10\text{V}$: 0.075 max | | | | | |
| IR | | More than $500 \mu\Omega$ or $25 \mu\Omega \times \mu\text{F}$ (Whichever is Smaller) | | | | | | | |
| | | | 1000hrs $85^\circ\text{C}/85\%\text{RH}$, Rated Voltage and $1.3\sim 1.5\text{V}$, (add $100\text{k}\Omega$ resistor) Measurement at 24 ± 2 hrs after test conclusion The charge/discharge current is less than 50mA . | | | | | | |
| 7 | High Temperature Operating Life | Appearance | No abnormal exterior appearance | | | | | | |
| | | Capacitance Change | CLASS I | Within $\pm 3.0\%$ or $0.3\mu\text{F}$, (Whichever is larger) | | | | | |
| | | | CLASS II | Within $\pm 12.5\%$ | | | | | |
| | | Q | CLASS I | Capacitance $\geq 30\mu\text{F}$: $Q \geq 350$ $\geq 10\mu\text{F}$: $Q \geq 275 + (5/2) \times C$ $< 10\mu\text{F}$: $Q \geq 200 + 10 \times C$ (C : Capacitance) | | | | | |
| | | Tan δ | CLASS II | Rated Voltage $\geq 25\text{V}$: 0.035 max $\geq 16\text{V}$: 0.05 max $\geq 10\text{V}$: 0.075 max | | | | | |
| IR | | More than $1,000 \mu\Omega$ or $50 \mu\Omega \times \mu\text{F}$ (Whichever is smaller) | | | | | | | |
| | | | 1000hrs @ $\text{TA} = 125^\circ\text{C}$, 200% Rated Voltage, Measurement at 24 ± 2 hrs after test conclusion The charge/discharge current is less than 50mA . | | | | | | |
| 8 | External Visual | No abnormal exterior appearance | Microscope (x10) | | | | | | |
| 9 | Physical Dimensions | Within the specified dimensions | Using the calipers | | | | | | |
| 10 | Mechanical Shock | Appearance | No abnormal exterior appearance | | | | | | |
| | | Capacitance Change | CLASS I | Within $\pm 2.5\%$ or $0.25\mu\text{F}$, (Whichever is larger) | | | | | |
| | | | CLASS II | Within $\pm 10\%$ | | | | | |
| | | Q | CLASS I | Capacitance $\geq 30\mu\text{F}$: $Q \geq 1,000$ $< 30\mu\text{F}$: $Q \geq 400 + 20 \times C$ (C : Capacitance) | | | | | |
| | | Tan δ | CLASS II | Rated Voltage $\geq 25\text{V}$: 0.025 max $\geq 16\text{V}$: 0.035 max $\geq 10\text{V}$: 0.05 max | | | | | |
| IR | | More than $10,000 \mu\Omega$ or $500 \mu\Omega \times \mu\text{F}$ (Whichever is smaller) | | | | | | | |
| | | | Three shocks in each direction should be applied along 3 mutually perpendicular axes of the test specimen (18 shocks) | | | | | | |
| | | | <table border="1"> <thead> <tr> <th>Peakvalue</th> <th>Duration</th> <th>Wave</th> </tr> </thead> <tbody> <tr> <td>1,500G</td> <td>0.5ms</td> <td>Half sine</td> </tr> </tbody> </table> | Peakvalue | Duration | Wave | 1,500G | 0.5ms | Half sine |
| Peakvalue | Duration | Wave | | | | | | | |
| 1,500G | 0.5ms | Half sine | | | | | | | |

* For the more detail Specification, Please refer to the Samsung MLCC catalogue.

- Part Numbering System
- General Capacitors
- High Capacitance Capacitors
- Super Small Size Capacitors
- Medium-High Voltage Capacitors
- Array Type Capacitors
- Low ESL Capacitors
- Reliability Test Condition
- Premium Capacitors for Automotive Applications
- Packaging Specification
- Application Manual for Surface Mounting



| No | Item | | Performance | Test Condition | |
|----|---------------------------|--|---------------------------------|--|---|
| 11 | Vibration | Appearance | No abnormal exterior appearance | 5g's for 20min., 12cycles each of 3 orientations, Use 8" x5" PCB 0.031" Thick 7 secure points on one long side and 2 secure points at corners of opposite sides. Parts mounted within 2" from any secure point. Test from 10~2000 Hz. | |
| | | Capacitance Change | CLASS I | | Within $\pm 2.5\%$ or 0.25pF, (Whichever is larger) |
| | | | CLASS II | | Within $\pm 10\%$ |
| | | Q | CLASS I | | Capacitance $\geq 30\text{pF}$: Q $\geq 1,000$ < 30pF : Q $\geq 400+20 \times C$ (C : Capacitance) |
| | | Tan δ | CLASS II | | Rated Voltage $\geq 25\text{V}$: 0.025 max $\geq 16\text{V}$: 0.035 max $\geq 10\text{V}$: 0.05max |
| IR | | More than 10,000 $\text{M}\Omega$ or 500 $\text{M}\Omega \times \mu\text{F}$ (Whichever is smaller) | | | |
| 12 | Resistance to Solder Heat | Appearance | No abnormal exterior appearance | Solder pot : 260 $\pm 5^\circ\text{C}$, 10 ± 1 sec. | |
| | | Capacitance Change | CLASS I | | Within $\pm 2.5\%$ or 0.25pF, (Whichever is larger) |
| | | | CLASS II | | Within $\pm 10\%$ |
| | | Q | CLASS I | | Capacitance $\geq 30\text{pF}$: Q $\geq 1,000$ < 30pF : Q $\geq 400+20 \times C$ (C : Capacitance) |
| | | Tan δ | CLASS II | | Rated Voltage $\geq 25\text{V}$: 0.025 max $\geq 16\text{V}$: 0.035 max $\geq 10\text{V}$: 0.05max |
| IR | | More than 10,000 $\text{M}\Omega$ or 500 $\text{M}\Omega \times \mu\text{F}$ (Whichever is smaller) | | | |
| 13 | Thermal Shock | Appearance | No abnormal exterior appearance | -55 $^\circ\text{C}/+125^\circ\text{C}$ Note: Number of cycles required - 300, Maximum transfer time-20 sec, Dwell time-15min. Air-Air | |
| | | Capacitance Change | CLASS I | | Within $\pm 2.5\%$ or 0.25pF, (Whichever is larger) |
| | | | CLASS II | | Within $\pm 10\%$ |
| | | Q | CLASS I | | Capacitance $\geq 30\text{pF}$: Q $\geq 1,000$ < 30pF : Q $\geq 400+20 \times C$ (C : Capacitance) |
| | | Tan δ | CLASS II | | Rated Voltage $\geq 25\text{V}$: 0.025 max $\geq 16\text{V}$: 0.035 max $\geq 10\text{V}$: 0.05max |
| IR | | More than 10,000 $\text{M}\Omega$ or 500 $\text{M}\Omega \times \mu\text{F}$ (Whichever is smaller) | | | |
| 14 | ESD | Appearance | No abnormal exterior appearance | AEC-Q200-002 | |
| | | Capacitance Change | CLASS I | | Within $\pm 2.5\%$ or 0.25pF, (Whichever is larger) |
| | | | CLASS II | | Within $\pm 10\%$ |
| | | Q | CLASS I | | Capacitance $\geq 30\text{pF}$: Q $\geq 1,000$ < 30pF : Q $\geq 400+20 \times C$ (C : Capacitance) |
| | | Tan δ | CLASS II | | Rated Voltage $\geq 25\text{V}$: 0.025 max $\geq 16\text{V}$: 0.035 max $\geq 10\text{V}$: 0.05max |
| IR | | More than 10,000 $\text{M}\Omega$ or 500 $\text{M}\Omega \times \mu\text{F}$ (Whichever is smaller) | | | |

* For the more detail Specification, Please refer to the Samsung MLCC catalogue.

| No | Item | Performance | Test Condition | | | | | | | | | | | | | | | | | | |
|---|--|---|---|---|-----------------|-----------|------|---------|----------|-------------|--------------------------|----------|-------------|---------------|----------|---------|--------------------------|---------------|---------|--------------|---------------|
| 15 | Solderability | 95% of the terminations is to be soldered evenly and continuously | a) Preheat at 155 °C for 4 hours, Immerse in solder for 5s at 235 ± 5 °C b) Steam aging for 8 hours, Immerse in solder for 5s at 235 ± 5 °C c) Steam aging for 8 hours, Immerse in solder for 120s at 260 ± 5 °C solder : a solution ethanol and rosin | | | | | | | | | | | | | | | | | | |
| 16 | Electrical Characterization | Capacitance | Within specified tolerance | | | | | | | | | | | | | | | | | | |
| | | Q | CLASS I Capacitance ≥ 30pF : Q ≥ 1,000 < 30pF : Q ≥ 400 + 20 × C (C: Capacitance) | | | | | | | | | | | | | | | | | | |
| | | Tanδ | CLASS II Rated Voltage ≥ 25V : 0.025 max ≥ 16V : 0.035 max ≥ 10V : 0.05max | | | | | | | | | | | | | | | | | | |
| | | IR@25 °C | CLASS I | More than 100,000 μΩ or 1,000 μΩ × μF (Whichever is smaller) | | | | | | | | | | | | | | | | | |
| | | | CLASS II | More than 10,000 μΩ or 500 μΩ × μF (Whichever is smaller) | | | | | | | | | | | | | | | | | |
| | | IR@125 °C | CLASS I | More than 10,000 μΩ or 100 μΩ × μF (Whichever is smaller) | | | | | | | | | | | | | | | | | |
| CLASS II | More than 1,000 μΩ or 10 μΩ × μF (Whichever is smaller) | | | | | | | | | | | | | | | | | | | | |
| Dielectric Strength | No dielectric breakdown or mechanical breakdown | | | | | | | | | | | | | | | | | | | | |
| <p>The Capacitance /D.F. should be measured at 25 °C,</p> <table border="1"> <thead> <tr> <th>Class</th> <th>Capacitance</th> <th>Frequency</th> <th>Vrms</th> </tr> </thead> <tbody> <tr> <td rowspan="2">Class I</td> <td>1000pF ↓</td> <td>1 kHz ± 10%</td> <td>0.5~5Vrms</td> </tr> <tr> <td>1000pF ↑</td> <td>1 kHz ± 10%</td> <td>1.0 ± 0.2Vrms</td> </tr> <tr> <td rowspan="2">Class II</td> <td>10 μF ↓</td> <td>1 kHz ± 10%</td> <td>1.0 ± 0.2Vrms</td> </tr> <tr> <td>10 μF ↑</td> <td>120 Hz ± 20%</td> <td>0.5 ± 0.1Vrms</td> </tr> </tbody> </table> <p>I.R. should be measured with a DC voltage not exceeding Rated Voltage @25 °C, @125 °C for 60~120 sec.</p> <p>Dielectric Strength : 250% of the rated voltage for 1~5 seconds The charge/discharge current is less than 50mA.</p> | | | | Class | Capacitance | Frequency | Vrms | Class I | 1000pF ↓ | 1 kHz ± 10% | 0.5~5Vrms | 1000pF ↑ | 1 kHz ± 10% | 1.0 ± 0.2Vrms | Class II | 10 μF ↓ | 1 kHz ± 10% | 1.0 ± 0.2Vrms | 10 μF ↑ | 120 Hz ± 20% | 0.5 ± 0.1Vrms |
| Class | Capacitance | Frequency | Vrms | | | | | | | | | | | | | | | | | | |
| Class I | 1000pF ↓ | 1 kHz ± 10% | 0.5~5Vrms | | | | | | | | | | | | | | | | | | |
| | 1000pF ↑ | 1 kHz ± 10% | 1.0 ± 0.2Vrms | | | | | | | | | | | | | | | | | | |
| Class II | 10 μF ↓ | 1 kHz ± 10% | 1.0 ± 0.2Vrms | | | | | | | | | | | | | | | | | | |
| | 10 μF ↑ | 120 Hz ± 20% | 0.5 ± 0.1Vrms | | | | | | | | | | | | | | | | | | |
| 17 | Board Flex | Appearance | No abnormal exterior appearance | | | | | | | | | | | | | | | | | | |
| | | Capacitance Change | CLASS I Within ± 5.0% or 0.5pF, (Whichever is larger) CLASS II Within ± 10% | | | | | | | | | | | | | | | | | | |
| <p>Bending to the limit for 5 seconds Limit : Class I - 3mm Class II - 2mm</p> | | | | | | | | | | | | | | | | | | | | | |
| 18 | Terminal Strength(SMD) | Appearance | No abnormal exterior appearance | | | | | | | | | | | | | | | | | | |
| | | Capacitance Change | CLASS I Within ± 2.5% or 0.25pF, (Whichever is larger) CLASS II Within ± 10% | | | | | | | | | | | | | | | | | | |
| <p>18N, for 60 ± 1 sec. * 0603(1608) -10N, 0402(1005) -2N</p> | | | | | | | | | | | | | | | | | | | | | |
| 19 | Beam Load | Destruction value should be exceed Chip Length ≤ 2.5mm a) Chip Thickness > 0.5mm : 20N b) Chip Thickness ≤ 0.5mm : 8N Chip Length ≥ 3.2mm a) Chip Thickness ≥ 1.25mm : 54.5N b) Chip Thickness < 1.25mm : 15N | Beam speed Chip Length ≤ 2.5mm, 0.5 ± 0.05 mm/sec Chip Length ≥ 3.2mm, 2.5 ± 0.25 mm/sec | | | | | | | | | | | | | | | | | | |
| 20 | Capacitance Temperature Characteristics | Capacitance Change | CLASS I 0 ± 30 ppm/°C | | | | | | | | | | | | | | | | | | |
| | | | CLASS II Within ± 15% | | | | | | | | | | | | | | | | | | |
| | | Temperature Coefficient | CLASS I 0 ± 30 ppm/°C | | | | | | | | | | | | | | | | | | |
| | | | CLASS I Within ± 0.2% or 0.05pF, (Whichever is larger) | | | | | | | | | | | | | | | | | | |
| <table border="1"> <thead> <tr> <th>Step</th> <th>Temperature(°C)</th> <th>Time(min)</th> </tr> </thead> <tbody> <tr> <td>1</td> <td>25 ± 2</td> <td>1</td> </tr> <tr> <td>2</td> <td>Min. Operating Temp. ± 2</td> <td>15 ± 3</td> </tr> <tr> <td>3</td> <td>25 ± 2</td> <td>1</td> </tr> <tr> <td>4</td> <td>Max. Operating Temp. ± 2</td> <td>15 ± 3</td> </tr> <tr> <td>5</td> <td>25 ± 2</td> <td>1</td> </tr> </tbody> </table> | | | | Step | Temperature(°C) | Time(min) | 1 | 25 ± 2 | 1 | 2 | Min. Operating Temp. ± 2 | 15 ± 3 | 3 | 25 ± 2 | 1 | 4 | Max. Operating Temp. ± 2 | 15 ± 3 | 5 | 25 ± 2 | 1 |
| Step | Temperature(°C) | Time(min) | | | | | | | | | | | | | | | | | | | |
| 1 | 25 ± 2 | 1 | | | | | | | | | | | | | | | | | | | |
| 2 | Min. Operating Temp. ± 2 | 15 ± 3 | | | | | | | | | | | | | | | | | | | |
| 3 | 25 ± 2 | 1 | | | | | | | | | | | | | | | | | | | |
| 4 | Max. Operating Temp. ± 2 | 15 ± 3 | | | | | | | | | | | | | | | | | | | |
| 5 | 25 ± 2 | 1 | | | | | | | | | | | | | | | | | | | |

* For the more detail Specification, Please refer to the Samsung MLCC catalogue.

Part Numbering System

General Capacitors

High Capacitance Capacitors

Super Small Size Capacitors

Medium-High Voltage Capacitors

Array Type Capacitors

Low ESL Capacitors

Reliability Test Condition

Premium Capacitors for Automotive Applications

Packaging Specification

Application Manual for Surface Mounting

Packaging Specifications

Cardboard Paper Tape(4mm)

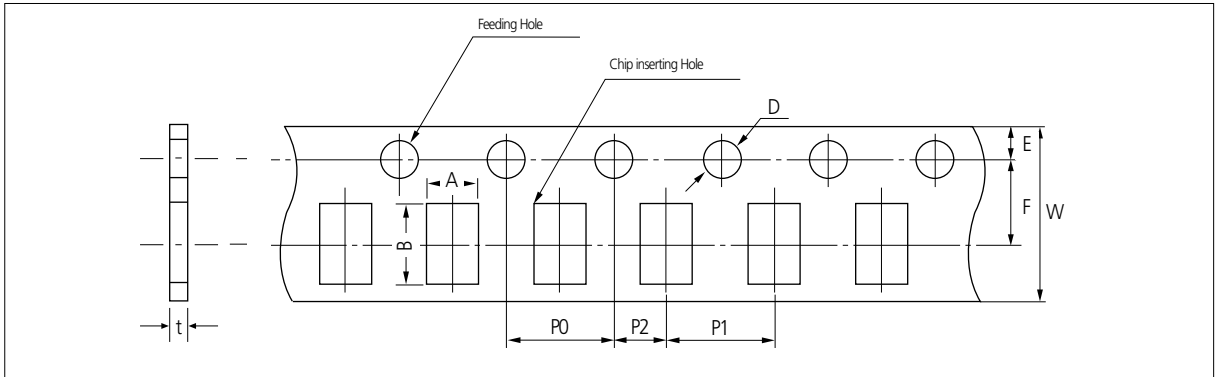

Unit: inch(mm)

| Symbol | | A | B | W | F | E | P1 | P2 | P0 | D | t |
|-----------|----------------------------|------------------|------------------|------------------|-------------------|-------------------|------------------|-------------------|------------------|--------------------------------|--------------|
| Type | | | | | | | | | | | |
| Dimension | 0504 (1410) | 1.3 ± 0.2 | 1.7 ± 0.2 | 8.0 ± 0.3 | 3.5 ± 0.05 | 1.75 ± 0.1 | 4.0 ± 0.1 | 2.0 ± 0.05 | 4.0 ± 0.1 | $\varnothing 1.5$ $+0.1/-0$ | 1.1 Below |
| | 0603 0306 (1608) (0816) | 1.1 ± 0.2 | 1.9 ± 0.2 | | | | | | | | |
| | 0805 0508 (2012) (1220) | 1.6 ± 0.2 | 2.4 ± 0.2 | | | | | | | | |
| | 1206 0612 (3216) (1632) | 2.0 ± 0.2 | 3.6 ± 0.2 | | | | | | | | |

Cardboard Paper Tape(2mm)

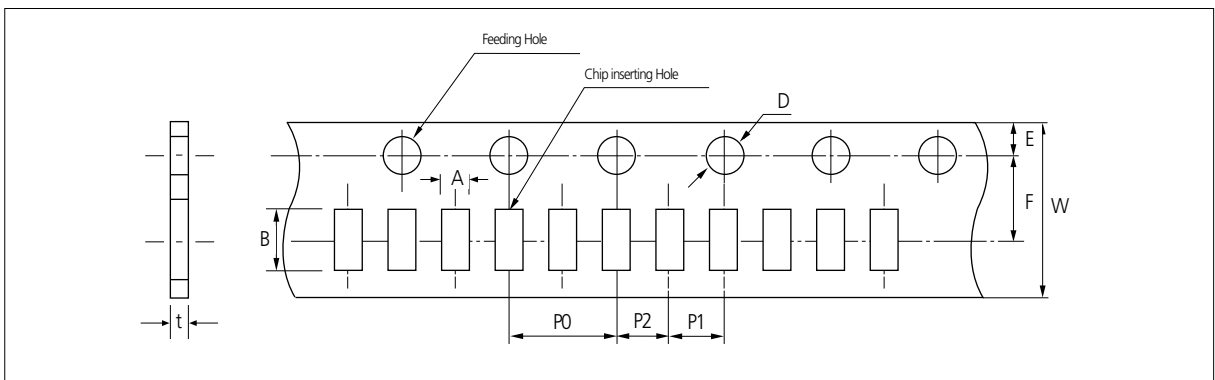

Unit: inch(mm)

| Symbol | | A | B | W | F | E | P1 | P2 | P0 | D | t | | |
|-----------|-----------------|--------------------|--------------------|------------------|-------------------|-------------------|-------------------|-------------------|------------------|-----------------------------------|--------------------|-----------------------------------|-------------------|
| Type | | | | | | | | | | | | | |
| Dimension | 01005 (0402) | 0.26 ± 0.03 | 0.46 ± 0.03 | 8.0 ± 0.3 | 3.5 ± 0.05 | 1.75 ± 0.1 | 2.0 ± 0.05 | 2.0 ± 0.05 | 4.0 ± 0.1 | $\varnothing 1.550$ ± 0.02 | 0.26 ± 0.03 | | |
| | 0201 (0603) | 0.38 ± 0.03 | 0.68 ± 0.03 | | | | | | | | | | |
| | 0402 (1005) | 0.62 ± 0.04 | 1.12 ± 0.04 | | | | | | | | | $\varnothing 1.5$ $+0.1/-0.03$ | 0.6 ± 0.05 |
| | | | | | | | | | | | | | |

Embossed Plastic Tape

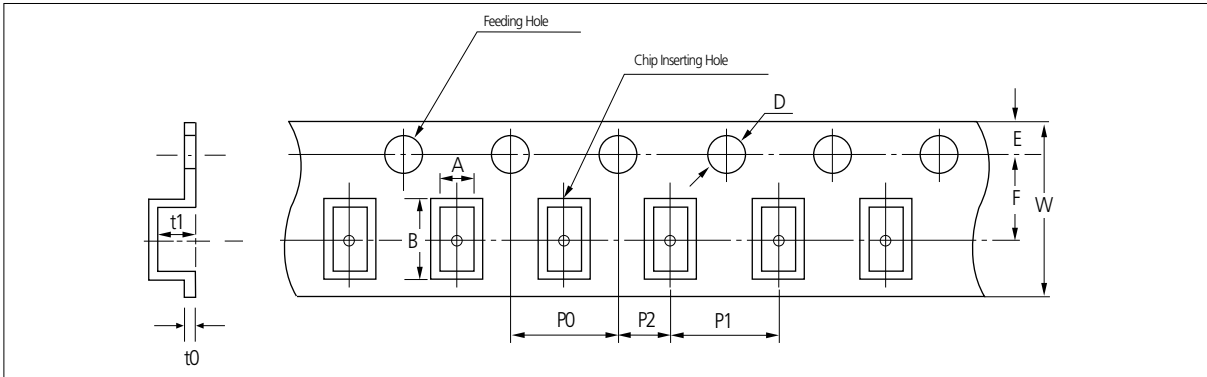

Unit: inch(mm)

| Symbol Type | | A | B | W | F | E | P1 | P2 | P0 | D | t1 | t0 |
|-------------|----------------------------|---------------|--------------|--------------|---------------|--------------|-------------|--------------|-------------|---------------------|------------|--------------|
| Dimension | 0603 (1608) | 1.05 ±0.15 | 1.9 ±0.15 | 8.0 ±0.3 | 3.5 ±0.05 | 1.75 ±0.1 | 4.0 ±0.1 | 2.0 ±0.05 | 4.0 ±0.1 | Ø1.5 +0.1/ -0 | 2.8 max | 0.6 BELOW |
| | 0805 (2012) | 1.45 ±0.2 | 2.3 ±0.2 | | | | | | | | | |
| | 1206 0612 (3216) (1632) | 1.9 ±0.2 | 3.5 ±0.2 | | | | | | | | | |
| | 1210 (3225) | 2.8 ±0.2 | 3.6 ±0.2 | 12.0 ±0.3 | 5.60 ±0.05 | 8.0 ±0.1 | 3.8 max | | | | | |
| | 1808 (4520) | 2.3 ±0.2 | 4.9 ±0.2 | | | | | | | | | |
| | 1812 (4532) | 3.6 ±0.2 | 4.9 ±0.2 | | | | | | | | | |
| | 2220 (5750) | 5.5 ±0.2 | 6.2 ±0.2 | | | | | | | | | |

Part Numbering System

General Capacitors

High Capacitance Capacitors

Super Small Size Capacitors

Medium-High Voltage Capacitors

Array Type Capacitors

Low ESL Capacitors

Reliability Test Condition

Premium Capacitors for Automotive Applications

Packaging Specification

Application Manual for Surface Mounting

Peeling off of Cover Tape

- $5 \text{ g.f} \leq \text{Peel off force} \leq 70 \text{ g.f}$

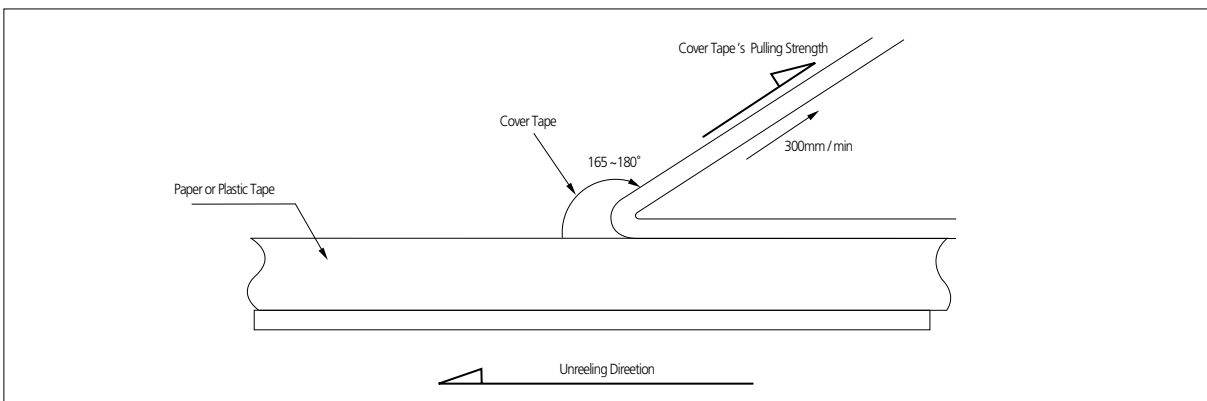

Reel Dimensions

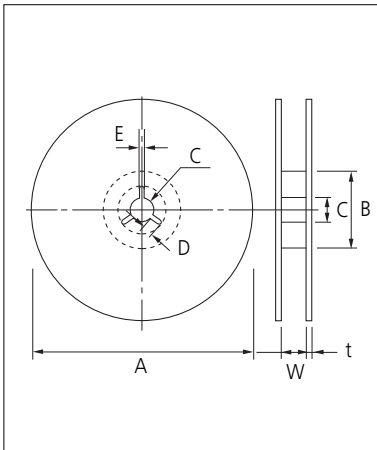

Unit: mm

| Symbol | Tape Width | A | B | C | D |
|----------|------------|--------------------------|-------------------------|-------------------------|------------|
| 7" Reel | 8mm | $\varnothing 180+0/-3$ | $\varnothing 60+1/-0$ | $\varnothing 13\pm 0.3$ | 4 ± 0.2 |
| | 12mm | $\varnothing 180+0/-3$ | $\varnothing 60+1/-0$ | $\varnothing 13\pm 0.3$ | 4 ± 0.2 |
| 10" Reel | 8mm | $\varnothing 258+0/-3$ | $\varnothing 80+1/-0$ | $\varnothing 13\pm 0.3$ | 4 ± 0.2 |
| | 12mm | $\varnothing 258+0/-3$ | $\varnothing 80+1/-0$ | $\varnothing 13\pm 0.3$ | 4 ± 0.2 |
| 13" Reel | 8mm | $\varnothing 330\pm 2.0$ | $\varnothing 80\pm 1.0$ | $\varnothing 13\pm 0.3$ | 4 ± 0.2 |
| | 12mm | $\varnothing 330\pm 2.0$ | $\varnothing 80\pm 1.0$ | $\varnothing 13\pm 0.3$ | 4 ± 0.2 |

| Symbol | Tape Width | E | W | t |
|----------|------------|--------------|-------------|--------------|
| 7" Reel | 8mm | 2.0 ± 0.5 | 9 ± 0.5 | 1.2 ± 0.2 |
| | 12mm | 2.0 ± 0.5 | 13 ± 0.5 | 1.2 ± 0.2 |
| 10" Reel | 8mm | 2.0 ± 0.5 | 9 ± 0.5 | 1.8 ± 0.2 |
| | 12mm | 2.0 ± 0.5 | 13 ± 0.5 | 1.8 ± 0.2 |
| 13" Reel | 8mm | 2.0 ± 0.5 | 9 ± 0.5 | 2.2 ± 0.2 |
| | 12mm | 2.0 ± 0.5 | 13 ± 0.5 | 2.2 ± 0.2 |

Bulk Case Packaging

- Bulk case packaging can reduce the stock space and transportation costs.
- The bulk feeding system can increase the productivity.
- It can eliminate the components loss.

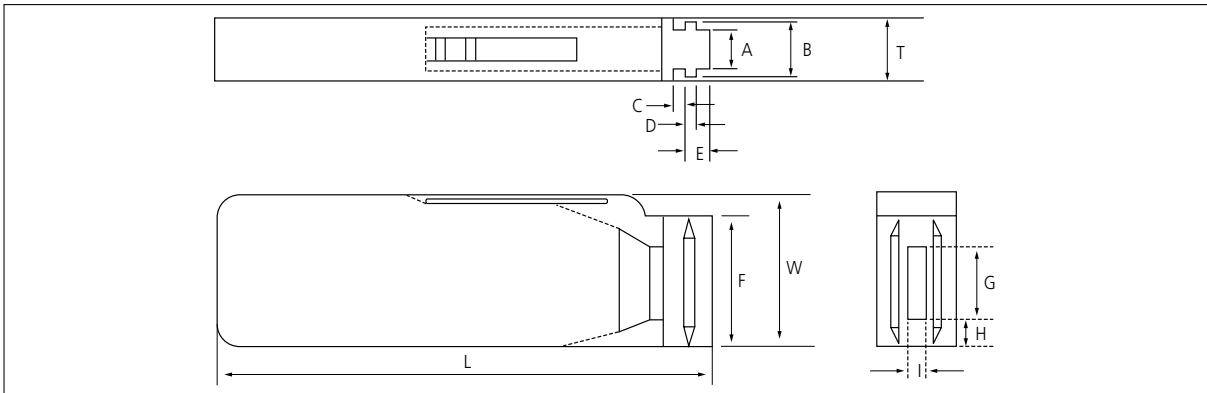

Unit: mm

| Symbol | A | B | T | C | D | E |
|-----------|--------------|--------------|-------------|--------------|------------|--------------|
| Dimension | 6.8 ± 0.1 | 8.8 ± 0.1 | 12 ± 0.1 | $1.5+0.1/-0$ | $2+0/-0.1$ | $3.0+0.2/-0$ |

| Symbol | F | W | G | H | L | I |
|-----------|---------------|-------------|--------------|-------------|--------------|-------------|
| Dimension | $31.5+0.2/-0$ | $36+0/-0.2$ | 19 ± 0.35 | 7 ± 0.35 | 110 ± 0.7 | 5 ± 0.35 |

• QUANTITY

Unit: inch(mm) and pcs

| Size | 0402(1005) | 0603(1608) | 0805(2012) | |
|----------|------------|------------------|------------|-----------------|
| | | | T=0.65mm | T=0.85mm |
| Quantity | 50,000 | 10,000 or 15,000 | 10,000 | 5,000 or 10,000 |

Part Numbering System

General Capacitors

High Capacitance Capacitors

Super Small Size Capacitors

Medium-High Voltage Capacitors

Array Type Capacitors

Low ESL Capacitors

Reliability Test Condition

Premium Capacitors for Automotive Applications

Packaging Specification

Application Manual for Surface Mounting

Application Manual for Surface Mounting

1. Storage of products

1-1. Storage Environment

Tape packing materials are designed to withstand long-term storage, but they will degrade more rapidly in the presence of high temperature or high humidity, Therefore, the products must be stored in an ambient 5~40°C with a relative humidity of 20~70%. Allowable storage period is within 6 months from the outgoing date of delivery.

1-2. Corrosive Gases

Since sulfur and chlorine may degrade the solderability of the end termination, it is important to store the capacitors in an environment free of these gases

1-3. Temperature Fluctuations

Since dew condensation may occur by the differences in temperature when the products are taken out of storage, it is important to maintain a temperature-controlled environment.

2. Design of Solder Land Pattern

When designing printed circuit boards, the shape and size of the solder lands must allow for the proper amount of solder on the capacitor. The amount of solder at the end terminations has a direct effect on the probability that the chip will crack. The greater amount of solder, the larger amount of stress on the chip, and the more likely that it will break. Use the following illustrations as guidelines for proper Solder land design.

Recommendation of solder Land Shape and Size

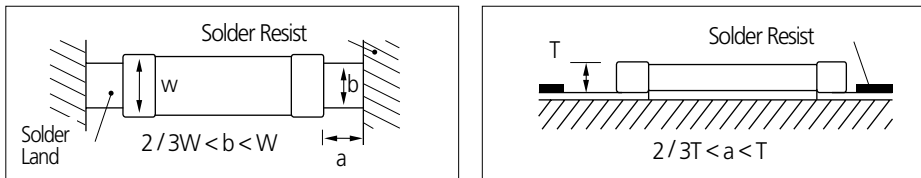

3. Adhesives

MLCCs generally require the use of an adhesive to position the chips to the circuit board prior to soldering.

3-1. Requirements for Adhesives

They must have enough adhesion so that the chips will not fall off or move during the handling of the circuit board.

They must maintain their adhesive strength when exposed to soldering temperatures.

They should not spread or run when applied to the circuit board.

They should have a long pot life.

They should harden quickly.

They should not corrode the circuit board or chip material.

They should be a good insulator.

They should be non-toxic, and not produce harmful gases, nor be harmful when touched.

3-2. Application Method

It is important to use the proper amount of adhesive. Too little will cause poor adhesion to the circuit board, and too much may strain the conductor pattern, thereby causing defective soldering. The following illustrations show the proper quantity of adhesive.

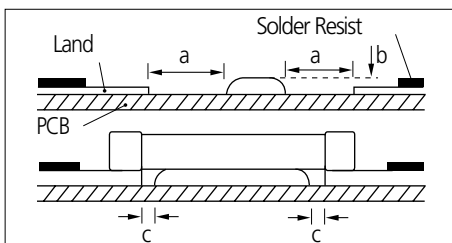

| Unit: mm | | |
|----------|----------|----------|
| Type | 21 | 31 |
| a | 0.2min | 0.2min |
| b | 70~100μm | 70~100μm |
| c | >0 | >0 |

3-3. Adhesive hardening Characteristics

To prevent oxidation of the terminations, the adhesive must harden at 160°C or less, within 2 minutes or less.

4. Mounting

4-1. Mounting Head Pressure

Excessive pressure will cause chip capacitors to crack. The pressure between nozzle and chip capacitor will be 300g maximum during mounting.

4-2. Bending Stress

Bending of printed circuit board by mounting head when double-sided circuit boards are used, chip capacitors first are mounted and soldered onto one side of the board. When the capacitors are mounted onto the other side, it is important to support the board as shown in the illustration. If the circuit board is not supported, it may bend, causing the already-installed capacitors to crack.

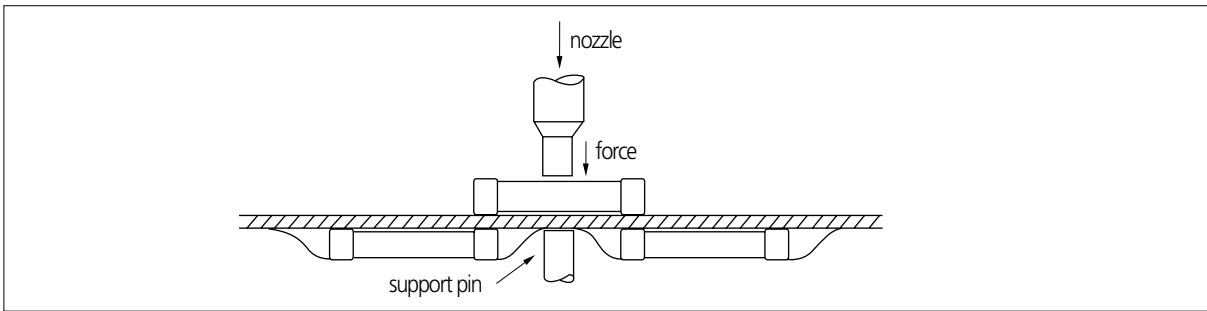

Part Numbering System

General Capacitors

High Capacitance Capacitors

Super Small Size Capacitors

Medium-High Voltage Capacitors

Array Type Capacitors

Low ESL Capacitors

Reliability Test Condition

Premium Capacitors for Automotive Applications

Packaging Specification

Application Manual for Surface Mounting

5. Flux

Although highly-activated flux gives better solderability, substances which increase activity may also degrade the insulation of the chip capacitors, To avoid such degradation, it is recommended that a mildly activated rosin flux (less than 0.2% chlorine) be used.

6. Soldering

Since a multilayer ceramic chip capacitor comes into direct contact with melted solder during soldering, it is exposed to potentially mechanical stress caused by the sudden temperature change. The capacitor may also be subject to silver migration, and to contamination by the flux. Because of these factors, soldering technique is critical.

6-1. Soldering Methods

| Method | Classification | |
|------------------|--------------------------------|---|
| Reflow soldering | · Overall heating | · Infrared rays · Hot plate · VPS (Vapor phase) |
| | · Local heating | · Air heater · Laser · Light beam |
| Flow Soldering | · Single wave · Double wave | |

6-2. Soldering Profile

To avoid the crack problem by sudden temperature change, follow the temperature profile in the adjacent graph.

6-2-1 Pb-Free (Sn 100%) Plating

▪ **REFLOW SOLDERING**

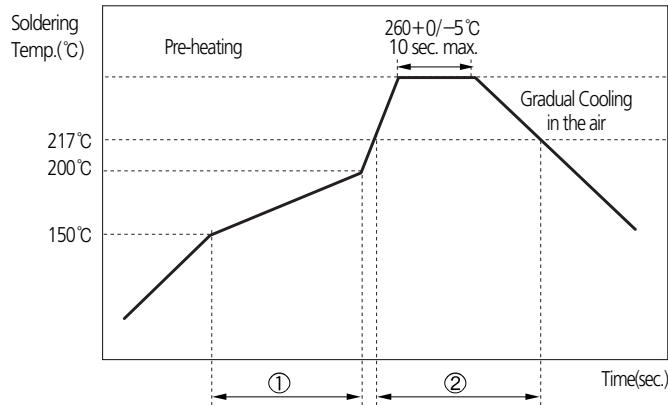

| Soldering Temp. (°C) | Pre-heating Time (①, sec.) | Soldering Time (②, sec.) |
|----------------------|----------------------------|--------------------------|
| 260+0/-5°C | 60~120 | 60~150 |

▪ **FLOW SOLDERING**

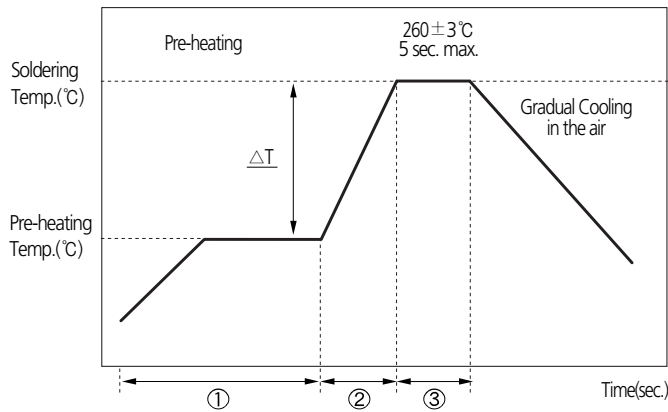

| ΔT (°C) | Soldering Temp. (°C) | Pre-heating Time (①+②, sec.) | Soldering Time (③, sec.) |
|-------------------------------------|----------------------|------------------------------|--------------------------|
| ≤ 150 (1206 and below size) | 260±3 | ≥ 120 | ≤ 5 |

▪ **SOLDER IRON(Hand Soldering)**

| Variation of Temp.(°C) | Soldering Temp(°C) | Pre-heating Time(sec.) | Soldering Time(sec.) | Cooling Time(sec.) | Condition of Iron Facilities | | |
|------------------------|--------------------|------------------------|----------------------|--------------------|------------------------------|--------------|----------------|
| | | | | | Wattage | Tip Diameter | Soldering Time |
| $\Delta T \leq 130$ | 300±10°C max. | ≥ 60 sec. | ≤ 4 sec. | - | 20W max. | 3mm max. | 4 sec max. |

※ Caution - Iron tip should not contact with ceramic body directly

6-3. Manual Soldering

Manual soldering can pose a great risk of creating thermal cracks in chip capacitors. The hot soldering iron tip comes into direct contact with the end terminations, and operator's carelessness may cause the tip of the soldering iron to come into direct contact with the ceramic body of the capacitor. Therefore the soldering iron must be handled carefully, and close attention must be paid to the selection of the soldering iron tip and to temperature control of the tip.

6-4. Amount of Solder

| | | |
|-------------------|--|--|
| Too much Solder | | Cracks tend to occur due to large stress. |
| Not enough solder | | Weak holding force may cause bad connections or detaching of the capacitor |

6-5. Cooling

Natural cooling using air is recommended. If the chips are dipped into solvent for cleaning, the temperature difference (ΔT) must be less than 100°C

6-6. Cleaning

If rosin flux is used, cleaning usually is unnecessary. When strongly activated flux is used, chlorine in the flux may dissolve into some types of cleaning fluids, thereby affecting the chip capacitors. This means that the cleaning fluid must be carefully selected, and should always be new.

7. Notes for Separating Multiple, Shared PC Boards

A multi-PC board is separated into many individual circuit boards after soldering has been completed. If the board is bent or distorted at the time of separation, cracks may occur in the chip capacitors. Carefully choose a separation method that minimizes the bending of the circuit board.

Part Numbering System

General Capacitors

High Capacitance Capacitors

Super Small Size Capacitors

Medium-High Voltage Capacitors

Array Type Capacitors

Low ESL Capacitors

Reliability Test Condition

Premium Capacitors for Automotive Applications

Packaging Specification

Application Manual for Surface Mounting



SAMSUNG
ELECTRO-MECHANICS





Passive components sales offices

• Head office

206, Cheomdansaneop Road,
Yeongtong-gu, Suwon-city,
Gyeonggi province, Korea,
443-743

Europe
Tel: +82-31-210-6328
E-mail: james.pyun@samsung.com

America
Tel: +82-31-210-6794
E-mail: randy.kim@samsung.com

Asia
Tel: +82-31-210-5348
E-mail: koogi@samsung.com

Domestic
Tel: +82-31-210-3757
E-mail: southjoy@samsung.com

• Manufacturing sites

Suwon Plant (Korea)
206, Cheomdansaneop Road,
Yeongtong-gu, Suwon-city,
Gyeonggi province, Korea,
443-743
Tel: +82-31-210-5074
E-mail: boungho.lee@samsung.com

Busan Plant (Korea)
1623-2, Songjeong-dong,
Gangseo-gu, Busan, Korea,
618-270
Tel: +82-51-970-7671
E-mail: kyc.kweon@samsung.com

Tianjin Plant (China)
27, Heiniucheng-Road, Hexi District,
Tianjin, 300210 China
Tel: +86-22-2397-9000(310)
E-mail: moohantop.Park@samsung.com

High Tech (China)
Xiqind Dist. Micro-Electronics
Industrial Park, Jingang Highway,
Tianjin, China 300485
Tel: + 022-23979000-313
E-mail: enhao.song@samsung.com

Philippines Plant (Philippines)
Block No.5, Calamba Premiere
International Park, Batino, Calamba,
Laguna, Manila, Philippines 4027
Tel: +63-49-545-0422
E-mail: donna@samsung.com

• Asia sales offices

Shenzhen Office
46 F, New World Center,
Yitian Road, Futian District,
Shenzhen, 518026 China
Tel: 86-755-8608-5571
E-mail: jackson.xian@samsung.com

Shanghai Office
Rm. 1211, Shanghai International
Trade Center, No. 2201 Yan an(W) Rd.,
Shanghai, 200335 China
Tel: 86-21-6270-4168(274)
E-mail: dennis.cha@samsung.com

HongKong Office
8/F, Central Plaza, 18 Harbour Road,
Wanchai, Hongkong, China
Tel: 852-28626344
E-mail: vivianchan@samsung.com

Qingdao Office
Rm 1201, Growne Plaza Qingdao 76,
Xiang Gang Zhong Rd, Qingdao,
266071 China
Tel: 86-532-85779102
E-mail: zhengguo.cui@samsung.com

Taiwan Office
9F-1, Np. 399 Ruey Kuang Rd., Neihu
District, Taipei City, Taiwan, 114
Tel: 886-2-2656-8356
E-mail: kevin0130.wang@samsung.com

Singapore Office
3 Church Street Samsung Hub,
#23-02 Singapore 049483
Tel: 65-6833-3228
E-mail: winson.yeong@samsung.com

Bangkok Office
23rd Floor, Lake Rajada Office Complex
193/89 Rachadapisek Road,
Khet Klongtoey, Bangkok 10110, Thailand
Tel: 66-2-661-8004~5
E-mail: yangshin.yi@samsung.com

• America sales office

Irvine Office
3345 Michelson Drive,
Suite 350, Irvine, CA 92612, USA
Tel: 1-949-797-8047
E-mail: sh386.kim@samsung.com

• Europe sales offices

Frankfurt Office
Samsung Haus, Am Kronberger Hang 6,
D-65824 Schwalbach/Ts. Germany
Tel: 49-6196-66-7255
E-mail: frank.goebel@samsung.com

Hungary Office
H-2310, Leshegy utca 2-4,
Szigetszentmiklos, Pest megye, Hungary
Tel: 36-24-551-148
E-mail: jun21c.lee@samsung.com

• Domestic Distributors

Korchip Corporation
817-38, Anyang 2-dong, Manan-gu,
Anyang-city, Gyeonggi province,
Korea, 430-812
Tel: +82-31-361-8100
E-mail: itasap@korchip.com

Chunghan
Chunghan Bldg., 121-284, Dangsang-dong,
Youngdeungpo-gu, Seoul, Korea
Tel: +82-2-718-3322
E-mail: ish@ichunghan.co.kr

SAMT
Daekyung Bldg., 983-10, Daechi-dong,
Gangnam-gu, Seoul, Korea
Tel: +82-2-3458-9000
E-mail: info@isamt.com

CHUNGMAC
#53-5 Wonhyoro-3ga Yongsan-gu,
Seoul, Korea
Tel: +82-31-234-2367~8
E-mail: webmaster@chungmac.co.kr

APEXINT
Room #905, C-dong Woorimlion's Valley
371-28, Gasan-dong, Guemcheon-gu,
Seoul, Korea
Tel: +82-2-2026-2610(2)
E-mail: info@apexint.co.kr