

D2n* Relay V23105

- Standard DIL relay
- Dimensions 20x10x11mm (.795x.394x.433")
- Switching and continuous current 3A
- 2 form C contacts (2 CO, 2 changeover contacts)
- Immersion cleanable
- Four different coil sensitivities, 150mW, 200mW, 400mW, >500mW
- Surge voltage resistance meets FCC Part 68 requirement: 1.5kV (10/700µs) between coil and contacts

Typical applications
Communications equipment, office equipment, measurement and control equipment, entertainment electronics, medical equipment, consumer electronics.

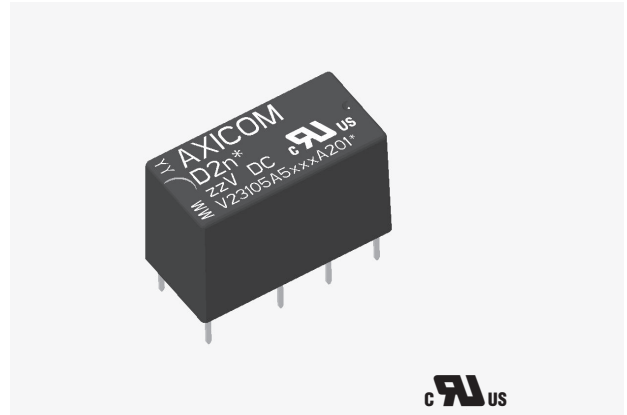

Approvals

UL 508; UL/CSA 60950-1 File No. E 111441
Technical data of approved types on request

Contact Data

Contact arrangement	2 form C (CO)
Max. switching voltage	220VDC, 250VAC
Rated current	3A
Limiting continuous current, 85°C	3A
Contact material	AgNi, gold-covered
Min. recommended contact load	10mA at 20mV
Minimum switching voltage	100µV
Initial contact resistance	<100mΩ at 10mA, 20mV
Frequency of operation without load	max. 50 operations/s
Operate / release time max.	6ms/4ms
Bounce time max.	5 ms
Electrical endurance	
at 230VAC/0.5A	typ. 3x10 ⁵ operations
at 6VDC/0.1A	typ. 2x10 ⁶ operations
at 30VDC/1A	typ. 5x10 ⁵ operations
at 30VDC/2A	typ. 1x10 ⁵ operations
Contact ratings, UL508	
	30VDC/1.0A
	100VDC/0.3A
	70VAC/0.5A
	70VAC/1.0A
Mechanical endurance	typ. 15x10 ⁶ operations

Coil Data

Magnetic system	neutral
Coil voltage range	3 to 48VDC
Max. coil temperature	85 °C
Thermal resistance	< 85K/W

Coil versions, monostable

Coil code	Rated voltage VDC	Operate voltage VDC _{min.}	Limiting Voltage VDC _{max.}	Release voltage VDC _{min.}	Coil resistance Ω±10%	Rated coil power mW
150mW coil power						
001	5	4.0	11.7	0.25	167	150
002	6	4.8	14.0	0.30	240	150
006	9	7.2	21.0	0.45	540	150
003	12	9.6	28.0	0.60	960	150
005	24	19.2	56.0	1.20	3840	150
200mW coil power						
308	3	2.1	6.1	0.15	45	200
301	5	3.5	10.1	0.25	125	200
302	6	4.2	12.2	0.30	180	200
306	9	6.3	18.2	0.45	405	200
303	12	8.4	24.3	0.60	720	200
305	24	16.8	48.6	1.20	2880	200
307	48	33.6	97.2	2.40	11520	200
400mW coil power						
401	5	3.5	7.2	0.25	62	400
402	6	4.2	8.6	0.30	90	400
406	9	6.3	12.9	0.42	203	400
403	12	8.4	17.2	0.60	360	400
405	24	16.8	34.3	1.20	1440	400
407	48	33.6	68.6	2.40	5760	400
>500mW coil power						
501	5	3.5	6.1	0.25	36	695
502	6	4.2	7.3	0.30	70	515
506	9	6.3	10.9	0.45	140	580
503	12	8.4	14.5	0.60	280	515
505	24	16.8	29.1	1.20	1050	550
507	48	33.6	58.1	2.40	4000	575

All figures are given for coil without pre-energization, at ambient temperature +23°C. Other coil voltages on request.

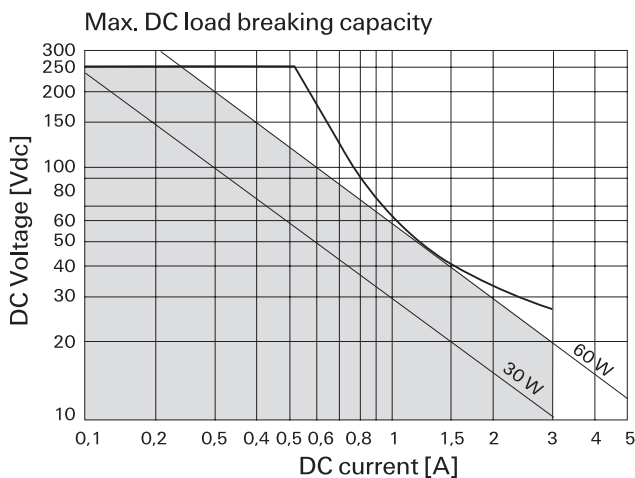

D2n* Relay V23105 (Continued)

Coil Data (continued)

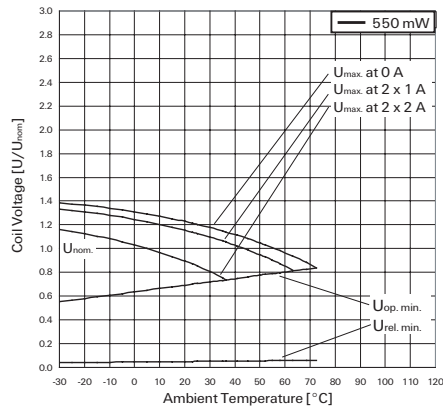
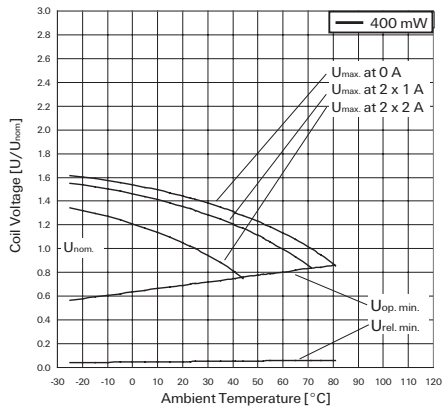
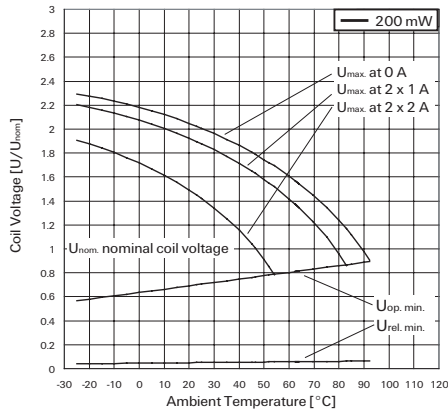
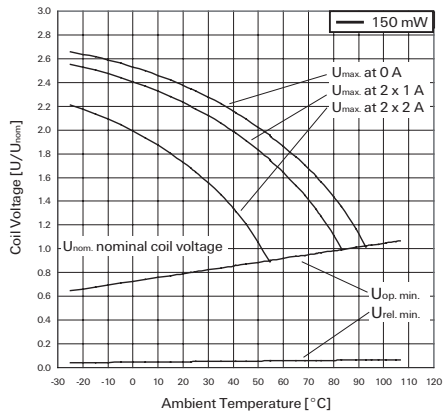

Coil Data (continued)

Coil operating range graphs

- U_{nom} Nominal coil voltage
- U_{max} Upper limit of the operative range of the coil voltage (limiting voltage) when coils are continuously energized
- $U_{op. min.}$ Lower limit of the operative range of the coil voltage (reliable operate voltage)
- $U_{rel. min.}$ Lower limit of the operative range of the coil voltage (reliable release voltage)

Insulation Data

Initial dielectric strength	
between open contacts	750V _{rms}
between contact and coil	1050V _{rms}
between adjacent contacts	750V _{rms}

Initial surge withstand voltage	
between open contacts	1500V
between contact and coil	1500V
between adjacent contacts	1500V

Initial insulation resistance at 500 VDC	> 10 ⁹ Ω
--	---------------------

Capacitance	
between open contacts	max. 2pF
between contact and coil	max. 4pF
between adjacent contacts	max. 2 pF

RF Data

Isolation at 100MHz/900MHz	-39.0dB/-20.7dB
Insertion loss at 100MHz/900MHz	-0.02dB/-0.27dB
Voltage standing wave ratio (VSWR) at 100MHz/900MHz	1.04/1.40

Other Data

Material compliance: EU RoHS/ELV, China RoHS, REACH, Halogen content refer to the Product Compliance Support Center at www.te.com/customer-support/rohssupportcenter

Ambient temperature	-40 to +85°C
Category of environmental protection	
IEC 61810	RT III - immersion cleanable
Degree of protection, IEC 60529	IP 67
Vibration resistance (functional)	10g, 10 to 55Hz
Shock resistance (functional)	
IEC 60068-2-27 (half sine)	10g
Shock resistance (destructive)	50g
Terminal type	PCB-THT
Weight	max. 6g
Resistance to soldering heat THT	
IEC 60068-2-20	265°C/10s
Ultrasonic cleaning	not recommended
Packaging unit	1000 pcs.

Terminal assignment

TOP view on component side of PCB

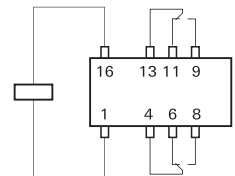

PCB layout

TOP view on component side of PCB

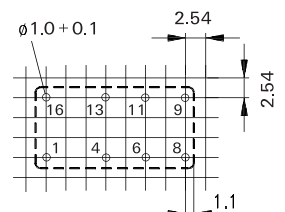

D2n* Relay V23105 (Continued)

Dimensions

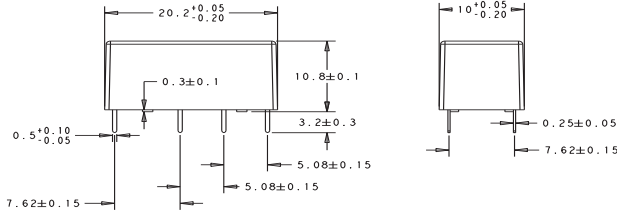

Packing

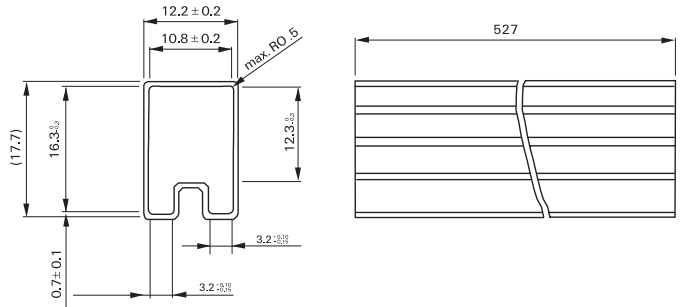

Product code structure

Typical product code

V23105-A5

001

A201

*

Type

V23105-A5 D2n Series Signal Relay

Coil

Coil code: please refer to coil versions table

0xx 150 mW **4xx** 400 mW
3xx 200 mW **5xx** 550 mW

Contacts

A201 2 from C, 2 CO, AgNi-Au contacts

* Version re-designed

Product code	Version	Coil power	Coil voltage	Part Number	
V23105A5001A201*	AgNi+Au	150mW	5VDC	8-1393792-5	
V23105A5002A201*	contacts		6VDC	8-1393792-7	
V23105A5006A201*			9VDC	9-1393792-1	
V23105A5003A201*			12VDC	8-1393792-8	
V23105A5005A201*			24VDC	9-1393792-0	
V23105A5308A201*			200mW	3VDC	1393793-5
V23105A5301A201*				5VDC	9-1393792-3
V23105A5302A201*				6VDC	9-1393792-5
V23105A5306A201*				9VDC	1393793-2
V23105A5303A201*				12VDC	9-1393792-7
V23105A5305A201*		24VDC		9-1393792-9	
V23105A5307A201*		48VDC		1393793-3	
V23105A5401A201*		400mW		5VDC	1393793-6
V23105A5402A201*				6VDC	1393793-7
V23105A5406A201*				9VDC	1-1393793-0
V23105A5403A201*			12VDC	1393793-8	
V23105A5405A201*			24VDC	1393793-9	
V23105A5407A201*			48VDC	1-1393793-1	
V23105A5501A201*			>500mW	5VDC	1-1393793-6
V23105A5502A201*				6VDC	1-1393793-8
V23105A5506A201*				9VDC	2-1393793-3
V23105A5503A201*				12VDC	1-1393793-9
V23105A5505A201*		24VDC		2-1393793-1	
V23105A5507A201*		48VDC		2-1393793-4	
V23105A5475A201*		BT 47 type		5VDC	1-1393793-2
V23105A5479A201*		spec T4563C		10VDC	3-1393794-0
V23105A5476A201*		(current tested)		12VDC	1-1393793-3
V23105A5477A201*				24VDC	1-1393793-4
V23105A5478A201*			48VDC	1-1393793-5	