

Pushbutton Switches, Panel Mount, Wire Lug or PC Tails, 6 Amp

MATERIAL SPECIFICATIONS:

ContactsSilver clad copper with gold flash
Case Material.....Thermoset
Actuator MaterialNickel plated copper alloy
Terminals.....Copper with gold flash
Terminal SealMolded in

ENVIRONMENTAL SPECIFICATIONS:

Operating Temperature-4°F to +176°F (-20°C to +80°C)
Storage Temperature-40°F to +176°F (-40°C to +80°C)
Solder Heat ResistanceSee page M3-4

Note: Hardware included with switches

TYPICAL PERFORMANCE CHARACTERISTICS:

Contact Rating.....6 A @ 125 VAC, 3 A @ 250 VAC
Initial Contact Resistance10 Milliohms max.
Contact TimingBreak-before-make
Insulation Resistance.....1,000 Megohms min.
Dielectric Strength.....1,500 Volts RMS @ sea level
Actuation Force1.3 to 2.7 lbs.
Actuator Travel140" (3.56)
Life Expectancy.....Up to 50,000 Actuations

Cap not supplied, order separately
(See Cap Model C22 and C23 on page D32.)

SPDT



MPA106D

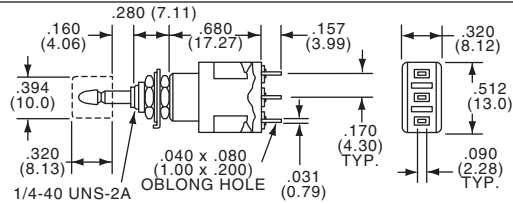
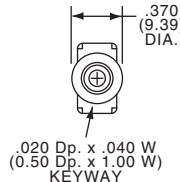
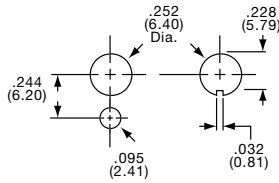

Part Number					
Tyco Electronics	Alcoswitch	Type	Act. Code	P. M6	Action
2-1437567-8	MPA106D	SPDT	23		Push-on/Push-off
2-1437567-9	MPA106F	SPDT	19		Momentary

DPDT



MPA206N

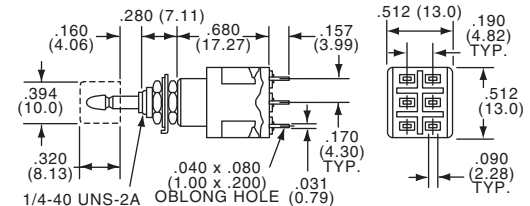
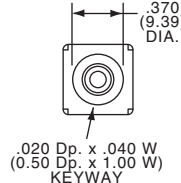
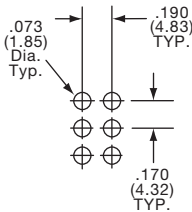

Part Number					
Tyco Electronics	Alcoswitch	Type	Act. Code	P. M6	Action
Wirelug Terminals					
3-1437567-1	MPA206N	DPDT	24		Push-on/Push-off
3-1437567-3	MPA206R	DPDT	20		Momentary

Part Number					
Tyco Electronics	Alcoswitch	Type	Act. Code	P. M6	Action
PC Terminals					
3-1437567-2	MPA206NPC	DPDT	24		Push-on/Push-off
3-1437567-4	MPA206RPC	DPDT	20		Momentary

3PDT



MPA306D

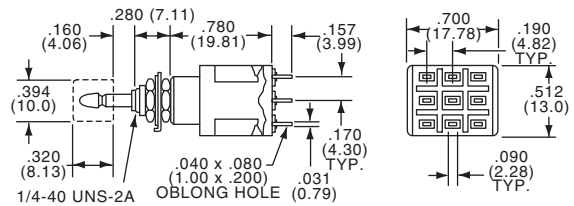
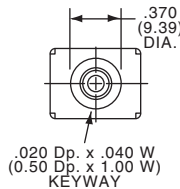
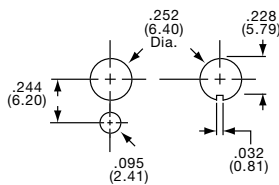

Part Number					
Tyco Electronics	Alcoswitch	Type	Act. Code	P. M6	Action
3-1437567-5	MPA306D	3PDT	25		Push-on/Push-off
3-1437567-6	MPA306F	3PDT	21		Momentary

4PDT



MPA406N

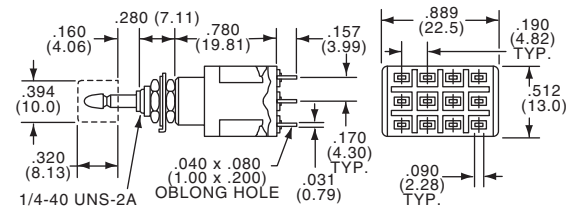
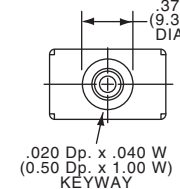
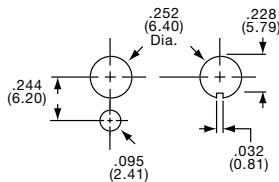

Part Number					
Tyco Electronics	Alcoswitch	Type	Act. Code	P. M6	Action
3-1437567-7	MPA406N	4PDT	26		Push-on/Push-off
3-1437567-8	MPA406R	4PDT	22		Momentary

Pushbutton Switches, Splashproof, Panel Mount, Wire Lug, 6 Amp

MATERIAL SPECIFICATIONS:

ContactsSilver clad copper with gold flash
Case MaterialThermoset
Actuator MaterialNickel plated copper alloy
TerminalsCopper with gold flash
Terminal SealMolded in

ENVIRONMENTAL SPECIFICATIONS:

Operating Temperature-4°F to +176°F (-20°C to +80°C)
Storage Temperature-40°F to +176°F (-40°C to +80°C)
Note: Hardware included with switches

TYPICAL PERFORMANCE CHARACTERISTICS:

Contact Rating6 A @ 125 VAC, 3 A @ 250 VAC
Initial Contact Resistance10 Milliohms max.
Contact TimingBreak-before-make
Insulation Resistance1,000 Megohms min.
Dielectric Strength1,500 Volts RMS @ sea level
Actuation Force1.3 to 2.7 lbs.
Actuator Travel140" (3.56)
Life ExpectancyUp to 50,000 Actuations

Notice: O-ring on shoulder and inside moveable shaft provides splashproof seal. Meets IP65

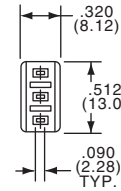
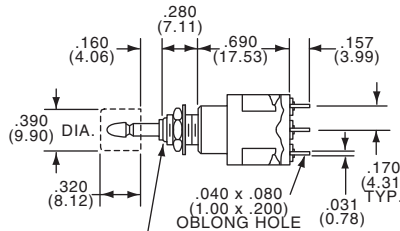
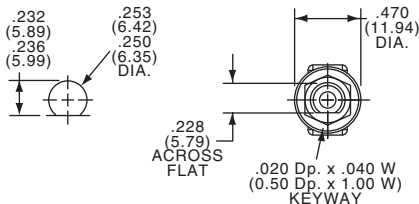

SPDT



MPE106D

Part Number		Act. Code		
Tyco Electronics	Alcoswitch	Type	P. M6	Action
4-1437567-2	MPE106D	SPDT	23	Push on/Push off
4-1437567-3	MPE106F	SPDT	19	Momentary

1/4-40 UNS-2A

Cap not supplied, order separately (See Cap Model C22 and C23 on page D32.)

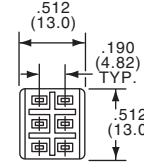
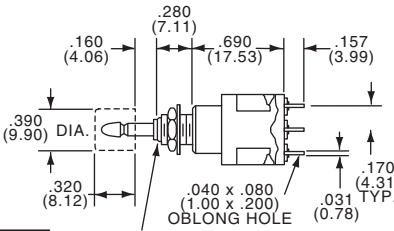
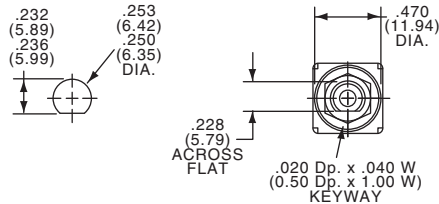

DPDT



MPE206N

Part Number		Act. Code		
Tyco Electronics	Alcoswitch	Type	P. M6	Action
4-1437567-4	MPE206N	DPDT	24	Push on/Push off
4-1437567-5	MPE206R	DPDT	20	Momentary

1/4-40 UNS-2A

Cap not supplied, order separately (See Cap Model C22 and C23 on page D32.)

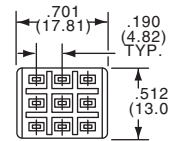
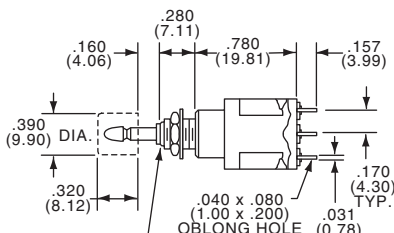
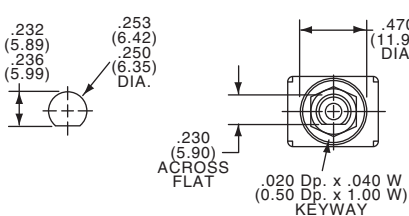

3PDT



MPE306F

Part Number		Act. Code		
Tyco Electronics	Alcoswitch	Type	P. M6	Action
—	MPE306D	3PDT	25	Push on/Push off
4-1437567-6	MPE306F	3PDT	21	Momentary

1/4-40 UNS-2A

Cap not supplied, order separately (See Cap Model C22 and C23 on page D32.)

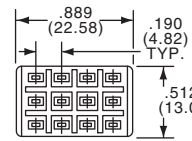
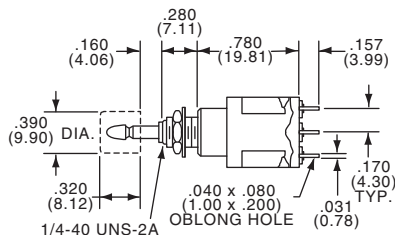
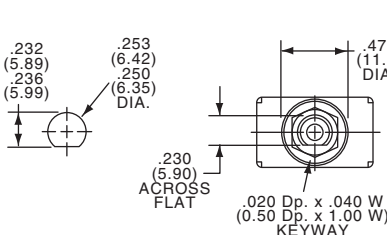

4PDT



MPE406N

Part Number		Act. Code		
Tyco Electronics	Alcoswitch	Type	P. M6	Action
4-1437567-7	MPE406N	4PDT	26	Push on/Push off
4-1437567-8	MPE406R	4PDT	22	Momentary

1/4-40 UNS-2A

Cap not supplied, order separately (See Cap Model C22 and C23 on page D32.)

Pushbutton Switches, 15/32 Bushing, Mustang, Wire Lug or PC Tails, 6 Amp

MATERIAL SPECIFICATIONS:

ContactsSilver clad copper with gold flash
 Case MaterialThermoset
 TerminalsCopper with gold flash finish
 Terminal SealMolded in

TYPICAL PERFORMANCE CHARACTERISTICS:

Contact Rating6 A @ 125 VAC, 3 A @ 250 VAC
 Initial Contact Resistance10 Milliohms max.
 Contact TimingBreak-before-make
 Insulation Resistance1,000 Megohms min.
 Dielectric Strength1,500 Volts RMS @ sea level
 Actuation Force1.3 to 2.7 lbs.
 Actuator Travel138" (3.51)
 Life ExpectancyUp to 50,000 Actuations
 Note: Hardware included with switches

ENVIRONMENTAL SPECIFICATIONS:

Operating Temperature.....-4°F to +176°F (-20°C to +80°C)
 Storage Temperature.....-40°F to +176°F (-40°C to +80°C)
 Solder Heat ResistanceSee page M3-4

SPDT

Black Cap supplied.



MPG106D

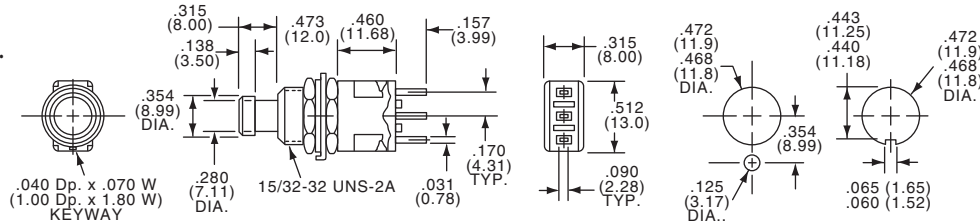

Other Caps Available, order separately
 (See Cap Model C9 on page D32.)

Part Number		Type	Act. Code	P. M6	Action	Terminals
Tyco Electronics	Alcoswitch					
4-1437567-9	MPG106D	SPDT	23		Push on/Push off	Wire Lug
5-1437567-0	MPG106F	SPDT	19		Momentary	Wire Lug

DPDT

Black Cap supplied.



MPG206NPC

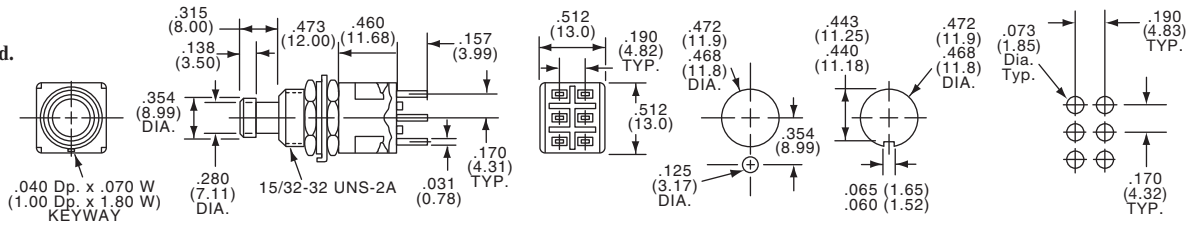

Other Caps Available, order separately
 (See Cap Model C9 on page D32.)

Part Number		Type	Act. Code	P. M6	Action	Terminals
Tyco Electronics	Alcoswitch					
5-1437567-1	MPG206N	DPDT	24		Push on/Push off	Wire Lug
5-1437567-3	MPG206R	DPDT	20		Momentary	Wire Lug
5-1437567-2	MPG206NPC	DPDT	24		Push on/Push off	PC
5-1437567-4	MPG206RPC	DPDT	20		Momentary	PC

3PDT

Black Cap supplied.



MPG306D

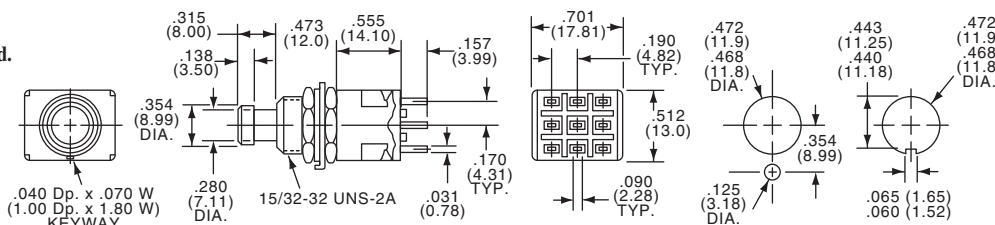

Other Caps Available, order separately
 (See Cap Model C9 on page D32.)

Part Number		Type	Act. Code	P. M6	Action	Terminals
Tyco Electronics	Alcoswitch					
5-1437567-5	MPG306D	3PDT	25		Push on/Push off	Wire Lug
5-1437567-6	MPG306F	3PDT	21		Momentary	Wire Lug

4PDT

Black Cap supplied.



MPG406N

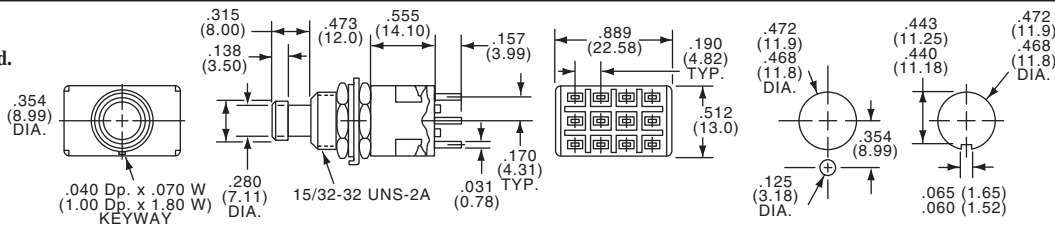

Other Caps Available, order separately
 (See Cap Model C9 on page D32.)

Part Number		Type	Act. Code	P. M6	Action	Terminals
Tyco Electronics	Alcoswitch					
5-1437567-7	MPG406N	4PDT	25		Push on/Push off	Wire Lug
5-1437567-8	MPG406R	4PDT	21		Momentary	Wire Lug

Pushbutton Switches, Snap Action, PC or Wire Wrap Tails, 3 Amp

SPDT/DPDT

SEE PAGE D25 FOR PRODUCT SPECIFICATIONS



MPS103FPC



MPS203RPC

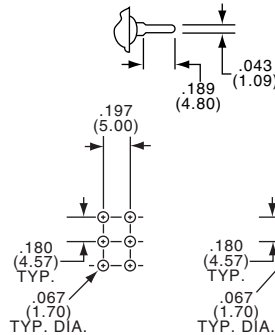
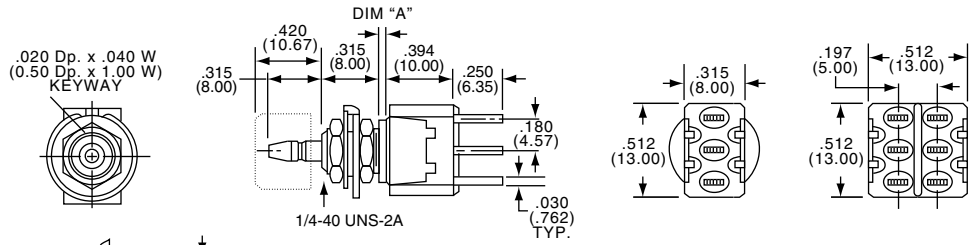

Part Number					
Tyco Electronics	Alcoswitch	Type	Action	Dim."A"	Terminals
6-1437567-0	MPS103DPC	SPDT	Push-on/Off	.100	PC Terminals
6-1437567-4	MPS103FPC	SPDT	Momentary	.040	PC Terminals
6-1437567-9	MPS203NPC	DPDT	Push-on/Off	.100	PC Terminals
7-1437567-3	MPS203RPC	DPDT	Momentary	.040	PC Terminals

Caps not supplied, order separately. (See Cap Model C22 and C23 on Page D32.)

SPDT/DPDT



MPS103FPCV



MPS203RPCV

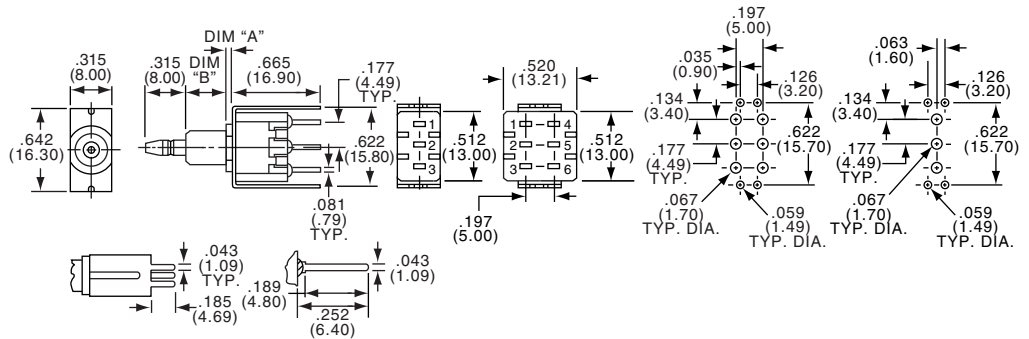

Part Number						
Tyco Electronics	Alcoswitch	Type	Action	Dim."A"	Dim."B"	Terminals
6-1437567-1	MPS103DPCV	SPDT	Push-on/Off	.080(2.03)	.315(8.00)	PC w/support
6-1437567-5	MPS103FPCV	SPDT	Momentary	.040(1.01)	.295(7.49)	PC w/support
7-1437567-4	MPS203RPCV	DPDT	Momentary	.040(1.01)	.295(7.49)	PC w/support

Caps not supplied, order separately. (See Cap Model C22 and C23 on Page D32.)

SPDT/DPDT



MPS103FWW



MPS203RWW

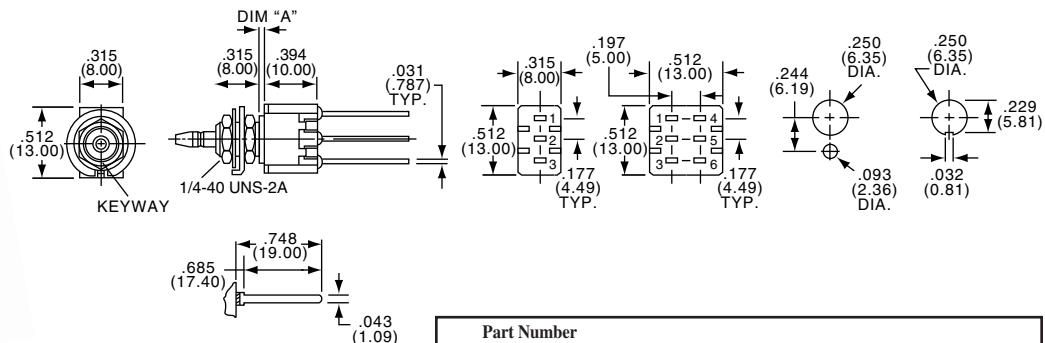

Part Number					
Tyco Electronics	Alcoswitch	Type	Action	Dim."A"	Terminals
6-1437567-7	MPS103FWW	SPDT	Momentary	.040(1.01)	Extended PC
-	MPS203NWW	DPDT	Push-on/Off	.100(2.54)	Extended PC
7-1437567-6	MPS203RWW	DPDT	Momentary	.040(1.01)	Extended PC

Caps not supplied, order separately. (See Cap Model C22 and C23 on Page D32.)

D
MPS Series

Pushbutton Switches, Snap Action, Right Angle, 3 Amp

SEE PAGE D25 FOR PRODUCT SPECIFICATIONS

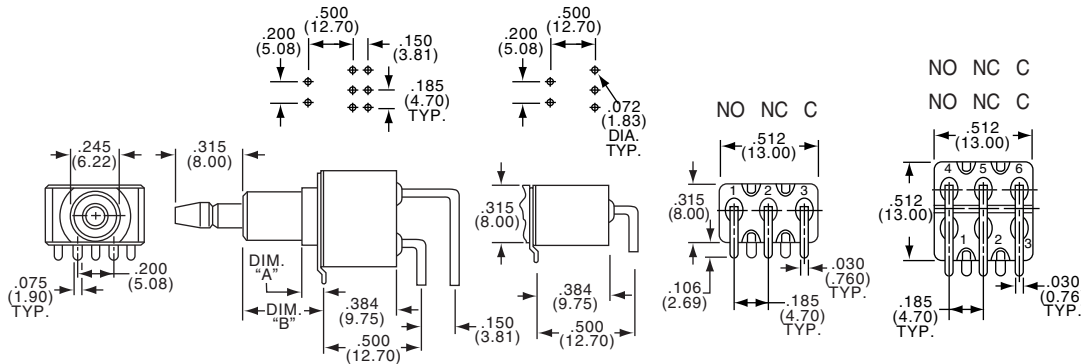

SPDT/DPDT



MPS103DRA



MPS203NRA

Part Number						
Tyco Electronics	Alcoswitch	Type	Action	Dim."A"	Dim."B"	Terminals
6-1437567-2	MPS103DRA	SPDT	Push-on/Off	.100(2.54)	.423(10.7)	Right Angle PC
6-1437567-6	MPS103FRA	SPDT	Momentary	.060(1.52)	.364(9.24)	Right Angle PC
7-1437567-1	MPS203NRA	DPDT	Push-on/Off	.100(2.54)	.423(10.7)	Right Angle PC
7-1437567-5	MPS203RRA	DPDT	Momentary	.060(1.52)	.364(9.24)	Right Angle PC

Caps not supplied, order separately.
(See Cap Model C22 and C23 on Page D32.)

MSP3/MSPS

Pushbutton Switches, 2.5mm Travel, Panel Mount

MATERIAL SPECIFICATIONS:

- ContactsSilver plate over copper alloy
- Case MaterialThermoplastic
- Actuator MaterialThermoplastic
- TerminalsSilver plate

ENVIRONMENTAL SPECIFICATIONS:

- Operating Temperature.....-4°F to +176°F (-20°C to +80°C)
- Storage Temperature.....+5°F to +153°F (-15°C to +75°C)
- Solder Heat ResistanceSee page M3-4
- Note: Hardware included with switches

TYPICAL PERFORMANCE CHARACTERISTICS:

- Contact RatingMSP103 - 3 Amps @ 125 VAC (with over travel) .059" (1.5mm)
MSPS103 - 0.5 Amps @ 125 VAC (Butt contact)
- Initial Contact Resistance100 Milliohms
- Contact TimingBreak-before-make
- Insulation Resistance1,000 Megohms min.
- Dielectric Strength1,000 Volts RMS @ sea level
- Life ExpectancyUp to 10,000 Cycles
- Travel2.5 mm

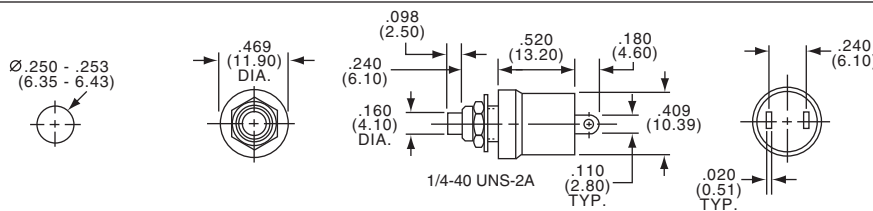

SPST



MSP103B

3 AMPS

Part Number						
Tyco Electronics	Alcoswitch	Type	Act. Code P. M6	Momentary Action	Bushing Length	Actuator Color
8-1437567-3	MSP103B	SPST	14	Normally Closed	.236	Black
8-1437567-4	MSP103C	SPST	13	Normally Open	.236	Red
8-1437567-5	MSP103C0	SPST	13	Normally Open	.236	Black
8-1437567-6	MSP103C2	SPST	13	Normally Open	.374	Red

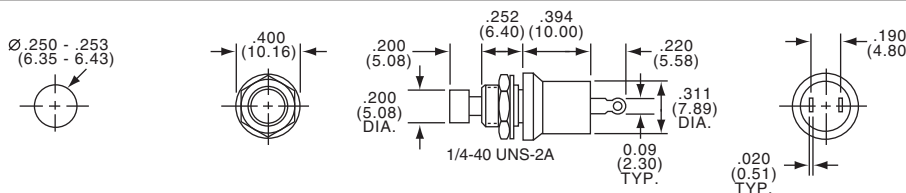

MSPS103B

0.5 AMPS

Part Number						
Tyco Electronics	Alcoswitch	Type	Act. Code P. M6	Momentary Action	Bushing Length	Actuator Color
1437568-5	MSPS103B	SPST	14	Normally Closed	.245	Black
1437568-6	MSPS103C2	SPST	13	Normally Open	.245	Red
1437568-7	MSPS103C0	SPST	13	Normally Open	.245	Black

Pushbutton Switches, Front or Rear Entry Mount, 15/32 Bushing

MATERIAL SPECIFICATIONS:

ContactsSilver plate
 Case MaterialThermoset
 Actuator MaterialThermoplastic
 TerminalsSilver plate
 Terminal SealEpoxy

TYPICAL PERFORMANCE CHARACTERISTICS:

Contact Rating0.5 A @ 125 VAC
 Initial Contact Resistance100 Milliohms
 Contact TimingBreak-before-make
 Insulation Resistance1,000 Megohms min.
 Dielectric Strength1,000 Volts RMS @ sea level
 Actuator Travel......098" (2.49)
 Life ExpectancyUp to 10,000 Cycles

ENVIRONMENTAL SPECIFICATIONS:

Operating Temperature.....-4°F to +176°F (-20°C to +80°C)
 Storage Temperature.....-4F to +176°F (-20°C to +80°C)

Application Note: Illustration shows versatile front or rear entry usage, with hardware supplied.

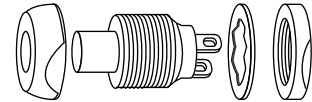

D

MSPF Series

SPST



MSPF101B

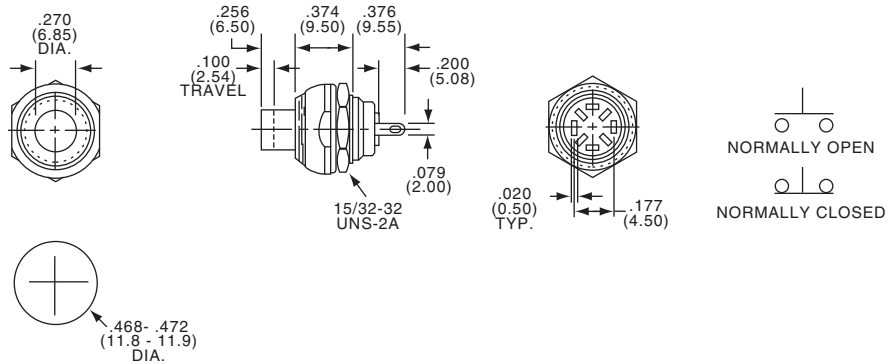

Part Number				
Tyco Electronics	Alcoswitch	Type	Action	Actuator Color
8-1437567-8	MSPF101B	SPST	Normally Closed	Black
9-1437567-3	MSPF101C	SPST	Normally Open	Red

2 CIRCUIT



MSPF101BC

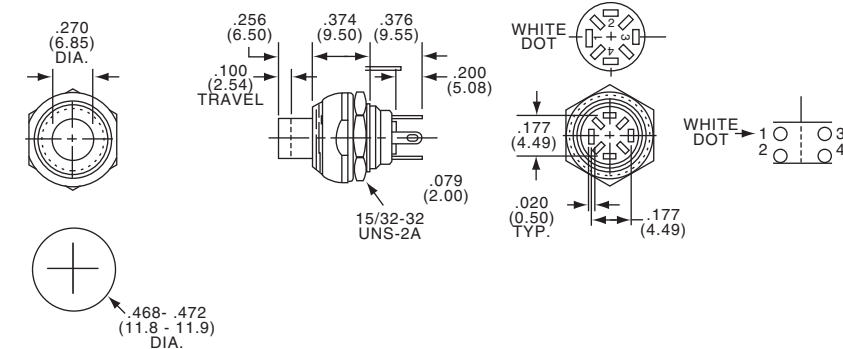

Part Number				
Tyco Electronics	Alcoswitch	Type	Action	Actuator Color
8-1437567-9	MSPF101BC0	2 Circuit	Normally open-normally closed	Black
9-1437567-0	MSPF101BC2	2 Circuit	Normally open-normally closed	Red
9-1437567-1	MSPF101BC6	2 Circuit	Normally open-normally closed	Blue
9-1437567-2	MSPF101BC9	2 Circuit	Normally open-normally closed	White

Pushbutton Switches, Magnetic Reed, Long Life, Hermetically Sealed

MATERIAL SPECIFICATIONS:

ContactsGold
 Case MaterialSteel
 Actuator MaterialPolyamide
 Terminals/Fixed Contacts.....Wire Lug
 Pin useable for PC applications

TYPICAL PERFORMANCE CHARACTERISTICS:

Contact Rating1.0 VA optimum (100 mA max., 100 VDC max.)
 Initial Contact Resistance100 Milliohms max.
 Actuation ForceTactile "keyboard feel" 4 to 7 oz.
 "breakaway" reducing immediately to 1.5 oz.
 "follow-through"
 Actuator Travel078" nominal
 Life Expectancy.....Up to 5,000,000 Cycles @ .1 VA; 50,000 cycles @ 5VA
 Solder Heat ResistanceSee page M3-4
 Note: Hardware included with switches

ENVIRONMENTAL SPECIFICATIONS:

Operating Temperature.....+14°F to +176°F (-10°C to +80°C)
 Storage Temperature.....+14°F to +176°F (-10°C to +80°C)

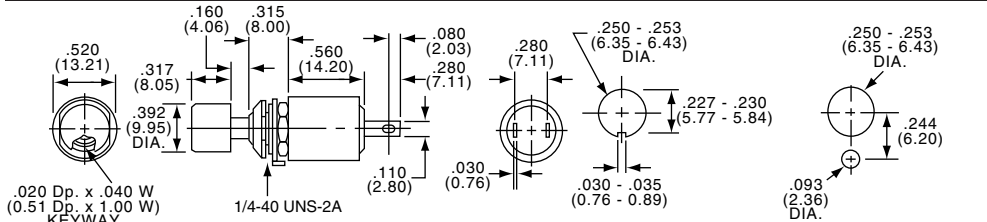

N.C. OR N.O.
SOFT DETENT



Part Number						
Tyco Electronics	Alcoswitch	Type	Act. Code	P. M6	Action	Terminals
9-1437567-4	MSPM101B0	SPST	14		Normally Closed	Pin
1437568-1	MSPM101C2	SPST	13		Normally Open	Pin
9-1437567-5	MSPM101B1	SPST	14		Normally Closed	Lug
9-1437567-9	MSPM101C1	SPST	13		Normally Open	Lug

Cap Model C22 supplied with unit.

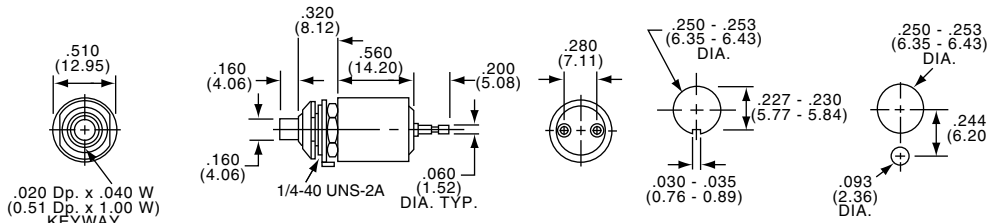

N.C. OR N.O.
AUDIBLE DETENT



Part Number						
Tyco Electronics	Alcoswitch	Type	Act. Code	P. M6	Action	Terminals
9-1437567-7	MSPM101BS	SPST	14		Normally Closed	Pin
1437568-3	MSPM101CS	SPST	13		Normally Open	Pin
9-1437567-8	MSPM101BS1	SPST	14		Normally Closed	Lug
1437568-4	MSPM101CS1	SPST	13		Normally Open	Lug

Pushbutton Switches, Push-Pull, Magnetic Reed, Long Life, Hermetically Sealed

SPECIFICATIONS (Same as above except):

Travel125" (3.18) nominal

Actuation ForceTactile feel 5 to 8 oz. "breakaway" with magnetically accelerated "follow-through"

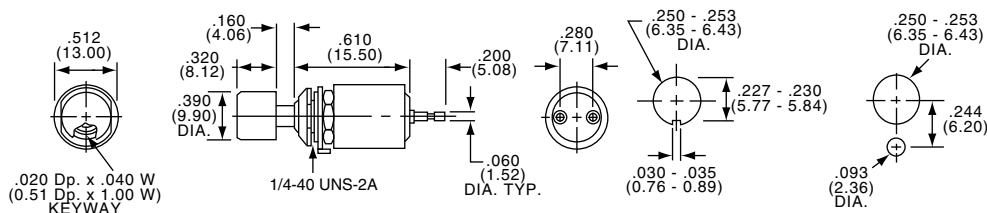

N.C. OR N.O.



Part Number						
Tyco Electronics	Alcoswitch	Type	Act. Code	P. M6	Push Pull	Terminals
9-1437567-6	MSPM101BP	SPST	18		Open Closed	Pin
1437568-2	MSPM101CP	SPST	17		Closed Open	Pin

Cap Model C22 supplied with unit.
 Model C23 available, order separately. (See Page D32.)

Push Switch, JLS Series

MATERIAL SPECIFICATIONS:

ContactsSilver clad copper
 FrameSteel
 Actuator MaterialAcetal
 Terminals/Fixed Contacts.....Brass, silver plate
 InsulatorPhenol

TYPICAL PERFORMANCE CHARACTERISTICS:

Contact Rating1 Amp @25 VDC
 Initial Contact Resistance100 Milliohms
 Actuation Force300±150 gms
 Actuator Travel0.091 (2.3)
 Life Expectancy.....Up to 10,000 cycles

ENVIRONMENTAL SPECIFICATIONS:

Operating Temperature.....+14°F to +140°F (-10°C to +60°C)

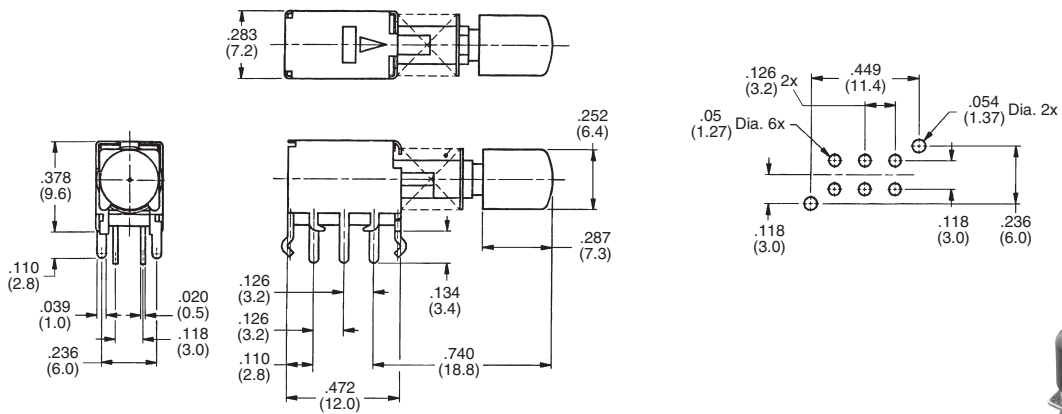

Part Number			
Tyco Electronics	Alcoswitch	Act. Code P. M6	Actuator Type
1437566-8	JLS91439FKBC	N	Black Cap
1437566-7	JLS91439FK	N	Gray Cap
1437566-9	JLS91439FWC	N	White Cap

D
MSPM, JLS Series

Pushbutton Switches, Splashproof Boot Seals

A wide selection of stock boot seals for pushbuttons are available in a variety of styles and thread sizes. ALCOSWITCH seals replace standard mounting hardware to provide environmental seal. Fabricated of Neoprene in black and optional red or gray. Custom colors and thread sizes are also available on special order.



BP10480

10-48 PUSHBUTTON BOOT SEALS

Splashproof seal designed for "TINY" pushbutton switches having a 10-48 bushing and .14" long button actuators. The hex nut is molded-in to the Neoprene seal. No O-Ring is required. Custom colors are available on special order.

Part Number					
Tyco Electronics	Alcoswitch	Mount Color	Boot Color	Thread Size	Use with Switch Types
1-1437626-4	BP10480	Black	Black	10-48	TP Series
1-1437626-5	BP10482	Red	Red	10-48	TP Series
1-1437626-6	BP10488	Gray	Gray	10-48	TP Series

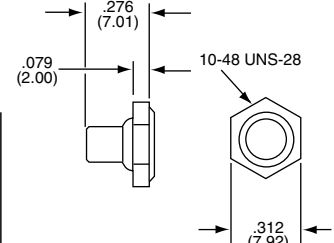

BPA14400



BP14400

1/4-40 PUSHBUTTON BOOT SEALS

Splashproof seals for miniature pushbuttons having a 1/4-40 bushing. The two models allow use with buttons that extend up to .17" (BPA) or up to .33" (BP). The hex nut is molded-in and no O-Ring is required.

Part Number					
Tyco Electronics	Alcoswitch	Mount Color	Boot Color	Thread Size	Use with Switch Types
1-1437626-7	BP14400	Black	Black	1/4-40	MSPM, MPA3, MPS and TP Series
1-1437626-8	BP14402	Red	Red	1/4-40	MSPM, MPA3, MPS and TP Series
1-1437626-9	BP14408	Gray	Gray	1/4-40	MSPM, MPA3, MPS and TP Series
2-1437626-7	BPA14400	Black	Black	1/4-40	MSPMBS, MSPMCS, MSP3, MPA3, TP Series
2-1437626-8	BPA14402	Red	Red	1/4-40	MSPMBS, MSPMCS, MSP3, MPA3, TP Series
2-1437626-9	BPA14408	Gray	Gray	1/4-40	MSPMBS, MSPMCS, MSP3, MPA3, TP Series

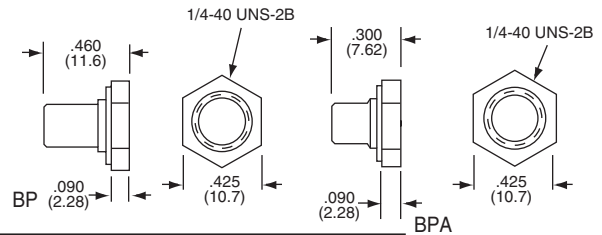

BP20100



BP1900

1/4-40 PUSHBUTTON BOOT SEALS

Splashproof seals having 1/4-40 blind nuts integrally mounted to the black Neoprene seal. Supplied with a captive O-Ring to complete the panel seal. Used with actuators up to .37" long. Choice of two-tone with nickel finish knurled ring or all black.

Part Number					
Tyco Electronics	Alcoswitch	Mount Color	Boot Color	Thread Size	Use with Switch Types
2-1437626-3	BP1900	Nickel	Black	1/4-40	MSPM, MSP3, MPA3 and TP Series
2-1437626-4	BP2010	Black	Black	1/4-40	MSPM, MSP3, MPA3 and TP Series

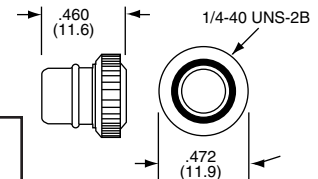

BP15320

15/32-32 PUSHBUTTON BOOT SEALS

Splashproof seals incorporating a molded-in hex nut for water tight and dust tight protection. Replaces standard hardware usually supplied. Recommended for large size pushbutton switches with actuators extending up to .31" long.

Part Number					
Tyco Electronics	Alcoswitch	Mount Color	Boot Color	Thread Size	Use with Switch Types
2-1437626-0	BP15320	Black	Black	15/32-32	MSPF and MPG Series
2-1437626-1	BP15322	Red	Red	15/32-32	MSPF and MPG Series
2-1437626-2	BP15328	Gray	Gray	15/32-32	MSPF and MPG Series

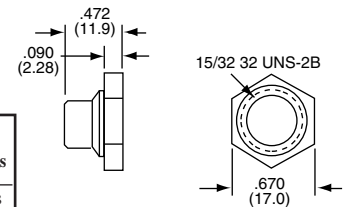

BP5900



BP5890

15/32-32 PUSHBUTTON BOOT SEALS

Splashproof seals having 15/32-32 hex shape mounts integrally bonded onto the black Neoprene seal. Supplied with a captive O-Ring for use against the panel. Readily accepts actuators up to .38" in length. Available in two tone with nickel finish hex-mount, or all black.

Part Number					
Tyco Electronics	Alcoswitch	Mount Color	Boot Color	Thread Size	Use with Switch Types
2-1437626-5	BP5890	Nickel	Black	15/32-32	MSPF and MPG Series
2-1437626-6	BP5900	Black	Black	15/32-32	MSPF and MPG Series

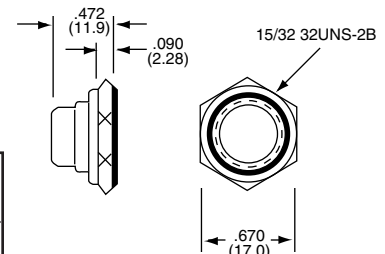

Pushbutton Switches, Accessories

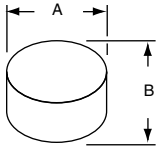

CAPS



C5



C22

Model	ID.	Description	Use Guard	Color	"A" Diameter	B Height
C5(*)	Snapfit	Small plastic cap for MPA3 Series	-	(0), (2), (5), (9)	.195	.120
C8(*)	Snapfit	Large plastic cap for MPA3 Series	-	(0), (2), (5), (9)	.310	.160
C9(*)	Snapfit	Spare color cap for MPG Series	-	(0), (2), (6), (9)	.354	.138
C22(*)	Snapfit	MPS/MSPM/MPE/MPA6	G12	(0), (2), (3), (4), (5), (6), (9)	.394	.315
C23(*)	Snapfit	MPS/MSPM/MPE/MPA6	G13	(0), (2), (3), (4), (5), (6), (9)	.590	.394
C33(*)	Snapfit	Square button for MSPR	-	(0), (2), (6), (9)	.378SQ.	.201

(*) Specify color by adding suffix number: (0) Black, (2) Red, (3) Orange, (4) Yellow, (5) Green, (6) Blue, (9) White.

D
Accessories

Part Number		Type	Color	Finish	Can be Used with Cap
Tyco Electronics	Alcoswitch				
7-1437627-6	G11A	10-48	Clear aluminum	Plain	C22 —
7-1437627-7	G11B	10-48	Black aluminum	Plain	C22 —
7-1437627-8	G11C	10-48	Chromed Brass	Plain	C22 —
8-1437627-1	G12A	1/4-40	Clear aluminum	Plain	C12 C22
8-1437627-2	G12B	1/4-40	Black aluminum	Plain	C12 C22
8-1437627-3	G12C	1/4-40	Chromed brass	Plain	C12 C22
8-1437627-4	G12KA	1/4-40	Clear aluminum	Knurled	C12 C22
8-1437627-5	G12KB	1/4-40	Black aluminum	Knurled	C12 C22
8-1437627-6	G12KC	1/4-40	Chromed brass	Knurled	C12 C22
8-1437627-7	G13A	1/4-40	Clear aluminum	Plain	C13 C23
8-1437627-8	G13B	1/4-40	Black aluminum	Plain	C13 C23
8-1437627-9	G13C	1/4-40	Chromed brass	Plain	C13 C23
9-1437627-0	G13KA	1/4-40	Clear aluminum	Knurled	C13 C23
9-1437627-1	G13KB	1/4-40	Black aluminum	Knurled	C13 C23
9-1437627-2	G13KC	1/4-40	Chromed brass	Knurled	C13 C23
9-1437627-3	G15*	15/32"	Chromed brass	Plain	—

*G15 Model used on the MSPF Series

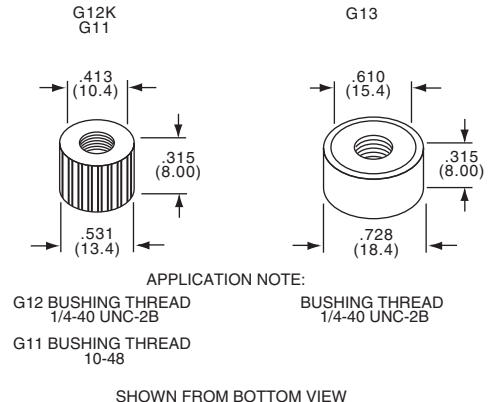

GUARDS



G12K



G13

DECORATIVE HARDWARE

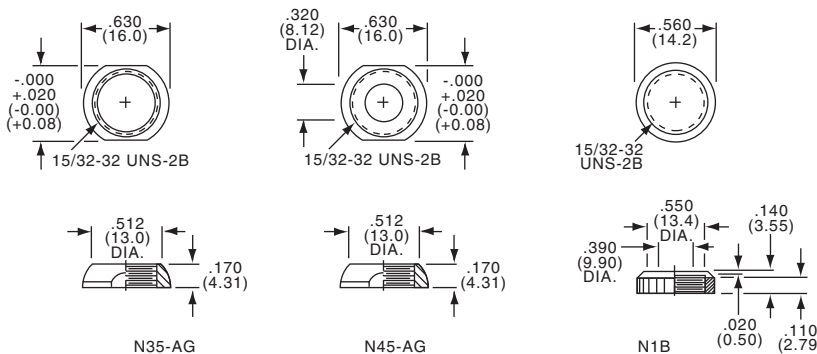

N35-AG



N1B



N45-AG

Part Number		Type	Description
Tyco Electronics	Alcoswitch		
1-1437628-0	N1B	15/32"	"Perfect Fit" knurled nut
1-1437628-4	N35-AG	15/32"	Decorative nut (supplied on switch)
1-1437628-7	N45-AG	15/32"	"Perfect Fit" decorative nut

Pushbutton Switches, Panel Seal

FEATURES

The BP Series offers a unique means of sealing pushbutton switches, using a standard 1/4-40 threading bushing, to almost any thickness panel. Simply install the BP adaptor into a 15/32" dia. or 1/2" dia. panel opening and secure with its hex nut. The switch is then threaded into the previously mounted adaptor and tightened into place. A complete and decorative panel seal is the result of the simple process.

MATERIALS

The flexible panel seal is custom molded of Neoprene rubber for long life, flexibility and chemical resistance. The threaded plastic adaptor is molded of ABS thermoplastic, is impact resistant and designed for ease of mounting.

BPM

For use with Miniature Pushbutton

The BPM seal adaptor accommodates all AUGAT/ALCOSWITCH MPA Series of pushbutton switches utilizing the 1/4-40 threaded bushing.



BPM15320

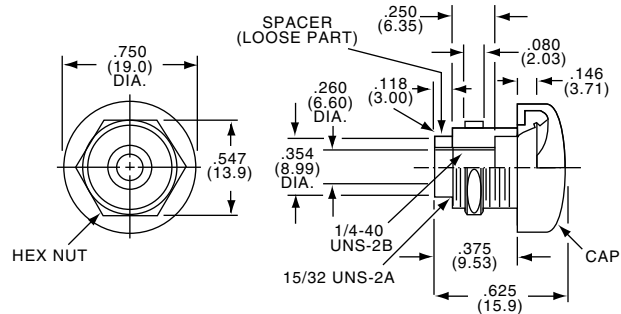

Part Number		
Tyco Electronics	Alcoswitch	Color* of Seal
3-1437626-0	BPM15320	Black
3-1437626-1	BPM15322	Red
3-1437626-2	BPM15328	Gray

(* Custom seal colors are available upon special request.

BPT

For use with Tiny Series TPF Pushbutton

The BPT seal adaptor accommodates all AUGAT/ALCOSWITCH TPF Series Tiny Pushbutton switches utilizing the 1/4-40 threading bushing.



BPT15328

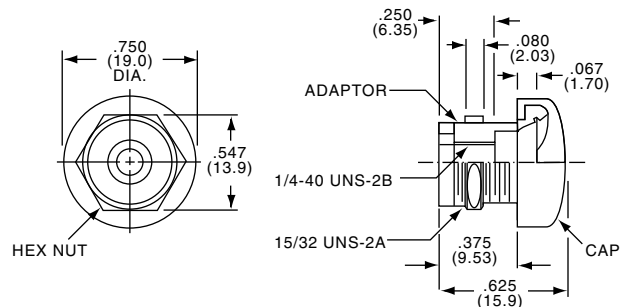

Part Number		
Tyco Electronics	Alcoswitch	Color* of Seal
3-1437626-3	BPT15320	Black
3-1437626-4	BPT15322	Red
3-1437626-5	BPT15328	Grey

(* Custom seal colors are available upon special request.

Engineering Notes



D

Engineering Notes