

PLASTIC PACKAGE INDUSTRIAL GRADE ULTRA MINIATURE PURE SILICON™ CLOCK OSCILLATOR

ASFLMB



Life Size



5.0 x 3.2 x 0.85mm

ASFLMB

Moisture Sensitivity Level – MSL 1  RoHS/RoHS II CompliantMEMS
TECHNOLOGY

FEATURES:

- Pure Silicon™ Clock Oscillator
- 2nd Generation MEMS Technology with reduced jitter by Discera
- Low Power Consumption <10mA
- Exceptional Stability +/- 10ppm Over Temp. at -40 to +105°C
- Compact QFN Plastic Packaging

APPLICATIONS:

- CCD Clock for VTR Camera
- Equipment Connected to PCs
- Low Profile Equipment
- Computers and Peripherals
- Lower Cost Crystal Oscillator Replacement
- Portable Electronics (MP3 Players, Games)
- Consumer Electronics such as TV's, DVR's, etc.
- Vibrant, Shock-Prone & Humid Environments for Industrial Equipment
- Demanding Military & Automotive Electronics

STANDARD SPECIFICATIONS:

Common Key Electrical Specifications

Parameters	Minimum	Typical	Maximum	Units	Notes
Frequency Range:	1.0		150	MHz	
Operating Temperature:	0		+70	°C	See options
Storage Temperature:	-55		+150	°C	
Overall Frequency Stability*:	-50		+50	ppm	See options
Supply Voltage (Vdd):	+1.8 ~ +3.3			V	
Output Load:			15, 25, or 40	pF	See options
	10			kΩ	
Symmetry:	45		55	%	@1/2Vdd
Startup Time:		1.5	3.0	ms	
Disable Time:		20	100	ns	
Disable Stand-by Current:			15	uA	
Tri-state Function (Stand-by) :	"1" (VIH≥0.75*Vdd) or Open: Oscillation "0" (VIL<0.25*Vdd) : Hi Z			V	
Aging:	-5.0	-----	+5.0	ppm	First year

Key Electrical Specifications V_{dd}= 1.8V

Parameters	Minimum	Typical	Maximum	Units	Notes
Supply Current (no load):	1.0 to 39.9999MHz		5	mA	CL=0p
	40.0 to 79.9999MHz		6	mA	RL=∞
	80.0 to 124.9999MHz		7	mA	T=25°C
	125.0 to 150MHz		8	mA	(Standard CL: 15pF)
	1.0 to 39.9999MHz		6	mA	CL=0p
	40.0 to 79.9999MHz		7	mA	RL=∞
	80.0 to 124.9999MHz		8	mA	T=25°C
	125.0 to 150MHz		9	mA	(CL option: 25pF)
	1.0 to 39.9999MHz		7	mA	CL=0p
	40.0 to 79.9999MHz		8	mA	RL=∞
	80.0 to 124.9999MHz		9	mA	T=25°C
	125.0 to 150MHz		10	mA	(CL option: 40pF)
Output Voltage:	V _{OH}	0.8*V _{dd}		V	
	V _{OL}		0.2*V _{dd}	V	CL=15, 25, 40pF
Rise Time: Fall Time:	T _r		1.8	ns	CL=15pF; T=25°C
	T _f		1.0	ns	20%/80%*VDD
	T _r		1.5	ns	CL=25pF; T=25°C
	T _f		1.2	ns	20%/80%*VDD
	T _r		1.4	ns	CL=40pF; T=25°C
	T _f		1.1	ns	20%/80%*VDD
Cycle to Cycle Jitter:		60		ps	F=100MHz
Period Jitter RMS:		10		ps	F=100MHz

ABRACON IS
ISO9001:2008
CERTIFIED



ABRACON LLC

2 Faraday, Suite# B | Irvine | CA 92618 Revised: 04.30.15

Ph. 949.546.8000 | Fax. 949.546.8001

Visit www.abracon.com for Terms and Conditions of Sale

PLASTIC PACKAGE INDUSTRIAL GRADE ULTRA MINIATURE PURE SILICON™ CLOCK OSCILLATOR

ASFLMB



ASFLMB



RoHS/RoHS II Compliant

Life Size



5.0 x 3.2 x 0.85mm

Key Electrical Specifications – $V_{dd}=2.5V$

Parameters		Minimum	Typical	Maximum	Units	Notes
Supply Current (no load):	1.0 to 39.9999MHz		6	15	mA	CL=0p RL=∞ T=25°C (Standard CL: 15pF)
	40.0 to 79.9999MHz		7	15	mA	
	80.0 to 124.9999MHz		8	15	mA	
	125.0 to 150MHz		9	15	mA	
	1.0 to 39.9999MHz		7	15	mA	CL=0p RL=∞ T=25°C (CL option: 25pF)
	40.0 to 79.9999MHz		8	15	mA	
	80.0 to 124.9999MHz		9	15	mA	
	125.0 to 150MHz		10	15	mA	
	1.0 to 39.9999MHz		8	16	mA	CL=0p RL=∞ T=25°C (CL option: 40pF)
	40.0 to 79.9999MHz		9	16	mA	
	80.0 to 124.9999MHz		10	16	mA	
	125.0 to 150MHz		11	16	mA	
Output Voltage:	V_{OH}	$0.8 \cdot V_{dd}$			V	CL=15, 25pF
	V_{OL}			$0.2 \cdot V_{dd}$	V	
	V_{OH}	$0.9 \cdot V_{dd}$			V	
	V_{OL}			$0.1 \cdot V_{dd}$	V	
Rise Time: Fall Time:	T_r		1.0	2.0	ns	CL=15pF; T=25°C 20%/80%*VDD
	T_f		0.9	2.0	ns	
	T_r		1.1	2.0	ns	CL=25pF; T=25°C 20%/80%*VDD
	T_f		0.9	2.0	ns	
	T_r		1.0	2.0	ns	CL=40pF; T=25°C 20%/80%*VDD
	T_f		0.9	2.0	ns	
Cycle to Cycle Jitter:			50		ps	F=100MHz
Period Jitter RMS:			5		ps	F=100MHz

PLASTIC PACKAGE INDUSTRIAL GRADE ULTRA MINIATURE PURE SILICON™ CLOCK OSCILLATOR

ASFLMB



Life Size



5.0 x 3.2 x 0.85mm

ASFLMB



RoHS/RoHS II Compliant

Key Electrical Specifications – $V_{dd}=3.3V$

Parameters		Minimum	Typical	Maximum	Units	Notes
Supply Current (no load):	1.0 to 39.9999MHz		7	15	mA	CL=0p RL=∞ T=25°C (Standard CL: 15pF)
	40.0 to 79.9999MHz		8	15	mA	
	80.0 to 124.9999MHz		9	15	mA	
	125.0 to 150MHz		10	15	mA	
	1.0 to 39.9999MHz		8	16	mA	CL=0p RL=∞ T=25°C (CL option: 25pF)
	40.0 to 79.9999MHz		9	16	mA	
	80.0 to 124.9999MHz		10	16	mA	
	125.0 to 150MHz		11	16	mA	
	1.0 to 39.9999MHz		8	16	mA	CL=0p RL=∞ T=25°C (CL option: 40pF)
	40.0 to 79.9999MHz		9	16	mA	
	80.0 to 124.9999MHz		10	16	mA	
	125.0 to 150MHz		11	16	mA	
Output Voltage:	V_{OH}	$0.8 \cdot V_{dd}$			V	CL=15pF
	V_{OL}			$0.2 \cdot V_{dd}$	V	
	V_{OH}	$0.9 \cdot V_{dd}$			V	
	V_{OL}			$0.1 \cdot V_{dd}$	V	
Rise Time: Fall Time:	Tr		1.0	2.0	ns	CL=15pF; T=25°C 20%/80%*VDD
	Tf		0.9	2.0	ns	
	Tr		1.0	2.0	ns	CL=25pF; T=25°C 20%/80%*VDD
	Tf		0.9	2.0	ns	
	Tr		0.8	2.0	ns	CL=40pF; T=25°C 20%/80%*VDD
	Tf		0.8	2.0	ns	
Cycle to Cycle Jitter:			50		ps	F=100MHz
Period Jitter RMS:			5		ps	F=100MHz

Absolute Maximum Ratings

Item	Minimum	Maximum	Unit	Condition
Supply Voltage	-0.3	+4.0	V	
Input Voltage	-0.3	V _{dd} +0.3	V	
Junction Temp.		+150	°C	
Storage Temp.	-55	+150	°C	
Soldering Temp.		+260	°C	40sec max
ESD			V	
HBM		4,000		
MM		200		
CDM		1,500		

PLASTIC PACKAGE INDUSTRIAL GRADE ULTRA MINIATURE PURE SILICON™ CLOCK OSCILLATOR

ASFLMB



Life Size

5.0 x 3.2 x 0.85mm

ASFLMB



RoHS/RoHS II Compliant

OPTIONS AND PART IDENTIFICATION: (Left Blank if Standard)

Programmed Orders (Quantity > 1,000pcs)

ASFLMB - MHz - - -

Frequency in MHz	Operating Temp.	Overall Freq. Stability	Output Load	Packaging
e.g. 14.3181 MHz (Maximum 4 digits after decimal)	Blank: 0°C ~ +70°C E: -20°C ~ +70°C L: -40°C ~ +85°C X: -40°C ~ +105°C	C: ±50ppm (STD) Y: ±10ppm R: ±25 ppm	Blank: 15pF 25: 25pF 40: 40pF	Blank*: 72pcs / Tube T: 1,000pcs / reel T3: 3,000pcs / reel

* For Quick turn-around programmable orders < 1000pcs: Due to the immediate availability of stock and the qty of the order, the parts may be delivered as BULK: Cut Tape, Loose parts in Antistatic Bag or in Tube(s). The MOQ per the series will still apply for Tube packaging.

Un-Programmed Orders

Blank un-programmed oscillators and our low cost portable programmer are available for quick turn engineering requirements. Please call ABRACON or visit MEMSpeed Pro site <http://www.abracon.com/memspeedpro/memspeedpro.html> for more information.

ASFLMB - BLANK - - - -

Operating Temp.	Overall Freq. Stability	Output Load	Packaging
Blank: 0°C ~ +70°C E: -20°C ~ +70°C L: -40°C ~ +85°C X: -40°C ~ +105°C	C: ±50ppm (STD) Y: ±10ppm R: ±25 ppm	Blank: 15pF 25: 25pF 40: 40pF	Blank: 72pcs / Tube T: 1,000pcs / reel T3: 3,000pcs / reel

PLASTIC PACKAGE INDUSTRIAL GRADE ULTRA MINIATURE PURE SILICON™ CLOCK OSCILLATOR

ASFLMB

Life Size

5.0 x 3.2 x 0.85mm

ASFLMB

Pb RoHS/RoHS II Compliant

OUTLINE DIMENSIONS:

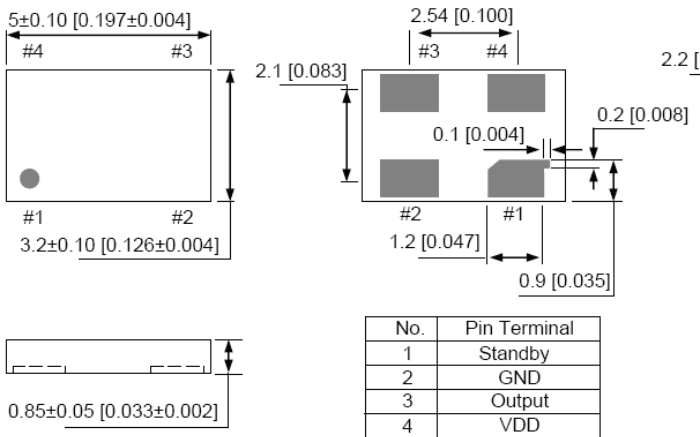

Recommended Land Pattern

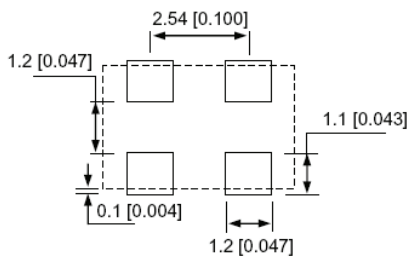

Note: Recommend using an approximately 0.01uF bypass capacitor between PIN 2 and 4.

Dimensions: mm (inches)

TAPE AND REEL:

T= 1,000pcs/reel (D=180mm)

T3= 3,000pcs/reel (D=330mm)

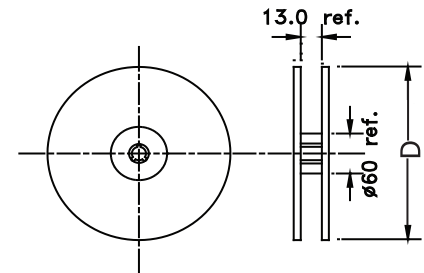
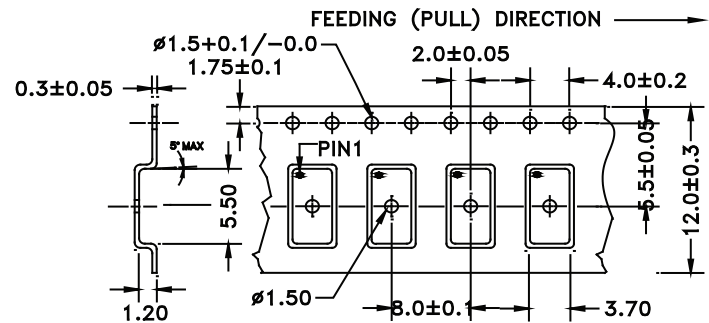
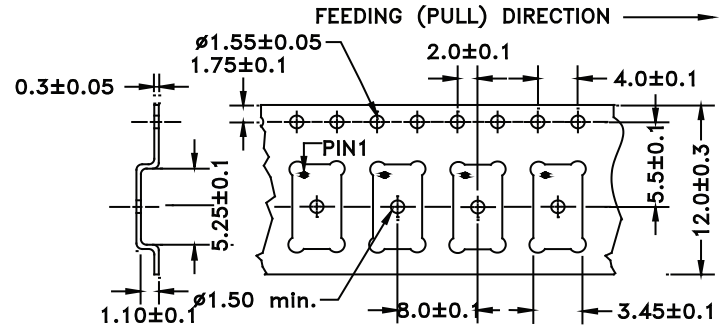

Tube: 72 pcs/tube

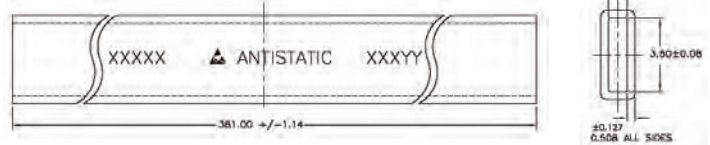

Unit orientation in tube:



Dimensions: mm

REFLOW PROFILE:

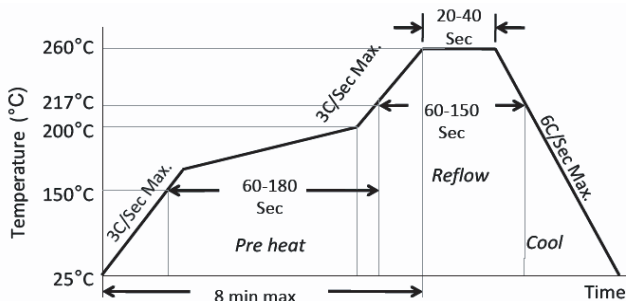

Ramp-Up Rate (200°C to Peak Temp)	3°C/Sec Max.
Preheat Time 150°C to 200°C	60-180 Sec
Time maintained above 217°C	60-150 Sec
Peak Temperature	255-260°C
Time within 5°C of actual Peak	20-40 Sec
Ramp-Down Rate	6°C/Sec Max.
Time 25°C to Peak Temperature	8 min Max.



Need a test socket for the ASFLMB Series? To view compatible **PRECISION TEST SOCKETS** for these parts, [click here](#): PN: **AXS-5032-04-07**.

ATTENTION: Abracon Corporation's products are COTS – Commercial-Off-The-Shelf products; suitable for Commercial, Industrial and, where designated, Automotive Applications. Abracon's products are not specifically designed for Military, Aviation, Aerospace, Life-dependant Medical applications or any application requiring high reliability where component failure could result in loss of life and/or property. For applications requiring high reliability and/or presenting an extreme operating environment, written consent and authorization from Abracon Corporation is required. Please contact Abracon Corporation for more information.

ABRACON IS
ISO9001:2008
CERTIFIED

ABRACON
The Power of Linking Together

2 Faraday, Suite# B | Irvine | CA 92618 Revised: 04.30.15

Ph. 949.546.8000 | Fax. 949.546.8001

Visit www.abracon.com for Terms and Conditions of Sale