

# MMBZxxxALT1G Series, SZMMBZxxxALT1G Series

## 24 and 40 Watt Peak Power Zener Transient Voltage Suppressors

### SOT-23 Dual Common Anode Zeners for ESD Protection

These dual monolithic silicon Zener diodes are designed for applications requiring transient overvoltage protection capability. They are intended for use in voltage and ESD sensitive equipment such as computers, printers, business machines, communication systems, medical equipment and other applications. Their dual junction common anode design protects two separate lines using only one package. These devices are ideal for situations where board space is at a premium.

#### Features

- SOT-23 Package Allows Either Two Separate Unidirectional Configurations or a Single Bidirectional Configuration
- Working Peak Reverse Voltage Range – 3 V to 26 V
- Standard Zener Breakdown Voltage Range – 5.6 V to 47 V
- Peak Power – 24 or 40 W @ 1.0 ms (Unidirectional), per Figure 6 Waveform
- ESD Rating:
  - Class 3B (> 16 kV) per the Human Body Model
  - Class C (> 400 V) per the Machine Model
- ESD Rating of IEC61000-4-2 Level 4, ±30 kV Contact Discharge
- Maximum Clamping Voltage @ Peak Pulse Current
- Low Leakage < 5.0 µA
- Flammability Rating UL 94 V-0
- SZ Prefix for Automotive and Other Applications Requiring Unique Site and Control Change Requirements; AEC-Q101 Qualified and PPAP Capable
- These Devices are Pb-Free and are RoHS Compliant

#### Mechanical Characteristics

**CASE:** Void-free, transfer-molded, thermosetting plastic case

**FINISH:** Corrosion resistant finish, easily solderable

**MAXIMUM CASE TEMPERATURE FOR SOLDERING PURPOSES:**

260°C for 10 Seconds

Package designed for optimal automated board assembly

Small package size for high density applications

Available in 8 mm Tape and Reel

Use the Device Number to order the 7 inch/3,000 unit reel.

Replace the “T1” with “T3” in the Device Number to order the

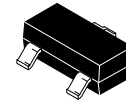
13 inch/10,000 unit reel.

This document contains information on some products that are still under development. ON Semiconductor reserves the right to change or discontinue these products without notice.

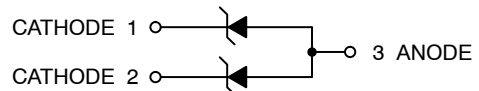


ON Semiconductor®

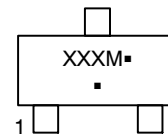
[www.onsemi.com](http://www.onsemi.com)



SOT-23  
CASE 318  
STYLE 12



#### MARKING DIAGRAM



XXX = Specific Device Code

M = Date Code

▪ = Pb-Free Package

(Note: Microdot may be in either location)

#### ORDERING INFORMATION

See detailed ordering and shipping information on page 2 of this data sheet.

#### DEVICE MARKING INFORMATION

See specific marking information in the device marking column of the table on page 3 of this data sheet.

## MMBZxxxALT1G Series, SZMMBZxxxALT1G Series

### MAXIMUM RATINGS

Rating	Symbol	Value	Unit
Peak Power Dissipation @ 1.0 ms (Note 1) @ $T_L \leq 25^\circ\text{C}$	$P_{pk}$	24 40	W
Total Power Dissipation on FR-5 Board (Note 2) @ $T_A = 25^\circ\text{C}$ Derate above $25^\circ\text{C}$	$P_D$	225	mW
		1.8	mW/ $^\circ\text{C}$
Thermal Resistance Junction-to-Ambient	$R_{\theta JA}$	556	$^\circ\text{C}/\text{W}$
Total Power Dissipation on Alumina Substrate (Note 3) @ $T_A = 25^\circ\text{C}$ Derate above $25^\circ\text{C}$	$P_D$	300	mW
		2.4	mW/ $^\circ\text{C}$
Thermal Resistance Junction-to-Ambient	$R_{\theta JA}$	417	$^\circ\text{C}/\text{W}$
Junction and Storage Temperature Range	$T_J, T_{stg}$	- 55 to +150	$^\circ\text{C}$
Lead Solder Temperature - Maximum (10 Second Duration)	$T_L$	260	$^\circ\text{C}$

Stresses exceeding those listed in the Maximum Ratings table may damage the device. If any of these limits are exceeded, device functionality should not be assumed, damage may occur and reliability may be affected.

1. Non-repetitive current pulse per Figure 6 and derate above  $T_A = 25^\circ\text{C}$  per Figure 7.
2. FR-5 = 1.0 x 0.75 x 0.62 in.
3. Alumina = 0.4 x 0.3 x 0.024 in, 99.5% alumina.

\*Other voltages may be available upon request.

### ORDERING INFORMATION

Device	Package	Shipping <sup>†</sup>
MMBZ5V6ALT1G	SOT-23 (Pb-Free)	3,000 / Tape & Reel
SZMMBZ5V6ALT1G	SOT-23 (Pb-Free)	3,000 / Tape & Reel
MMBZ5V6ALT3G	SOT-23 (Pb-Free)	10,000 / Tape & Reel
MMBZ6VxALT1G	SOT-23 (Pb-Free)	3,000 / Tape & Reel
SZMMBZ6VxALT1G	SOT-23 (Pb-Free)	3,000 / Tape & Reel
MMBZ6VxALT3G	SOT-23 (Pb-Free)	10,000 / Tape & Reel
MMBZ9V1ALT1G	SOT-23 (Pb-Free)	3,000 / Tape & Reel
MMBZ9V1ALT13G	SOT-23 (Pb-Free)	10,000 / Tape & Reel
MMBZxxVALT1G	SOT-23 (Pb-Free)	3,000 / Tape & Reel
SZMMBZxxVALT1G	SOT-23 (Pb-Free)	3,000 / Tape & Reel
MMBZxxVALT3G	SOT-23 (Pb-Free)	10,000 / Tape & Reel
SZMMBZxxVALT3G	SOT-23 (Pb-Free)	10,000 / Tape & Reel
SZMMBZxxVTALT1G	SOT-23 (Pb-Free)	3,000 / Tape & Reel

<sup>†</sup>For information on tape and reel specifications, including part orientation and tape sizes, please refer to our Tape and Reel Packaging Specifications Brochure, BRD8011/D.

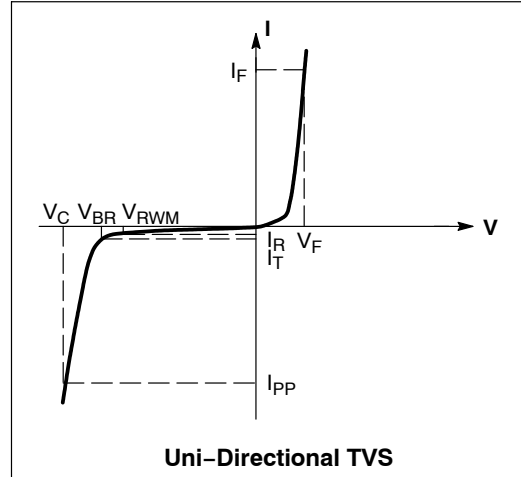
# MMBZxxxALT1G Series, SZMMBZxxxALT1G Series

## ELECTRICAL CHARACTERISTICS

(T<sub>A</sub> = 25°C unless otherwise noted)

**UNIDIRECTIONAL** (Circuit tied to Pins 1 and 3 or 2 and 3)

Symbol	Parameter
I <sub>PP</sub>	Maximum Reverse Peak Pulse Current
V <sub>C</sub>	Clamping Voltage @ I <sub>PP</sub>
V <sub>RWM</sub>	Working Peak Reverse Voltage
I <sub>R</sub>	Maximum Reverse Leakage Current @ V <sub>RWM</sub>
V <sub>BR</sub>	Breakdown Voltage @ I <sub>T</sub>
I <sub>T</sub>	Test Current
∅V <sub>BR</sub>	Maximum Temperature Coefficient of V <sub>BR</sub>
I <sub>F</sub>	Forward Current
V <sub>F</sub>	Forward Voltage @ I <sub>F</sub>
Z <sub>ZT</sub>	Maximum Zener Impedance @ I <sub>ZT</sub>
I <sub>ZK</sub>	Reverse Current
Z <sub>ZK</sub>	Maximum Zener Impedance @ I <sub>ZK</sub>



**ELECTRICAL CHARACTERISTICS** (T<sub>A</sub> = 25°C unless otherwise noted)

**UNIDIRECTIONAL** (Circuit tied to Pins 1 and 3 or Pins 2 and 3)

(V<sub>F</sub> = 0.9 V Max @ I<sub>F</sub> = 10 mA) (5% Tolerance)

**24 WATTS**

Device*	Device Marking	V <sub>RWM</sub> Volts	I <sub>R</sub> @ V <sub>RWM</sub> μA	Breakdown Voltage				Max Zener Impedance (Note 5)			V <sub>C</sub> @ I <sub>PP</sub> (Note 6)		∅V <sub>BR</sub> mV/°C
				V <sub>BR</sub> (Note 4) (V)			@ I <sub>T</sub>	Z <sub>ZT</sub> @ I <sub>ZT</sub>	Z <sub>ZK</sub> @ I <sub>ZK</sub>	V <sub>C</sub>	I <sub>PP</sub>		
				Min	Nom	Max	mA	Ω	Ω	mA	V	A	
MMBZ5V6ALT1G/T3G	5A6	3.0	5.0	5.32	5.6	5.88	20	11	1600	0.25	8.0	3.0	1.26
MMBZ6V2ALT1G	6A2	3.0	0.5	5.89	6.2	6.51	1.0	-	-	-	8.7	2.76	2.80
MMBZ6V8ALT1G	6A8	4.5	0.5	6.46	6.8	7.14	1.0	-	-	-	9.6	2.5	3.4
MMBZ9V1ALT1G	9A1	6.0	0.3	8.65	9.1	9.56	1.0	-	-	-	14	1.7	7.5

(V<sub>F</sub> = 0.9 V Max @ I<sub>F</sub> = 10 mA) (5% Tolerance)

**40 WATTS**

Device*	Device Marking	V <sub>RWM</sub> Volts	I <sub>R</sub> @ V <sub>RWM</sub> nA	Breakdown Voltage				V <sub>C</sub> @ I <sub>PP</sub> (Note 6)		∅V <sub>BR</sub> mV/°C
				V <sub>BR</sub> (Note 4) (V)			@ I <sub>T</sub>	V <sub>C</sub>	I <sub>PP</sub>	
				Min	Nom	Max	mA	V	A	
MMBZ12VALT1G	12A	8.5	200	11.40	12	12.60	1.0	17	2.35	7.5
MMBZ15VALT1G	15A	12	50	14.25	15	15.75	1.0	21	1.9	12.3
MMBZ16VALT1G	16A	13	50	15.20	16	16.80	1.0	23	1.7	13.8
MMBZ18VALT1G	18A	14.5	50	17.10	18	18.90	1.0	25	1.6	15.3
MMBZ20VALT1G	20A	17	50	19.00	20	21.00	1.0	28	1.4	17.2
MMBZ27VALT1G/T3G	27A	22	50	25.65	27	28.35	1.0	40	1.0	24.3
MMBZ33VALT1G	33A	26	50	31.35	33	34.65	1.0	46	0.87	30.4
MMBZ47VALT1G**	47A	38	50	44.65	47	49.35	1.0	54	0.74	42.3

(V<sub>F</sub> = 0.9 V Max @ I<sub>F</sub> = 10 mA) (2% Tolerance)

**40 WATTS**

Device*	Device Marking	V <sub>RWM</sub> Volts	I <sub>R</sub> @ V <sub>RWM</sub> nA	Breakdown Voltage				V <sub>C</sub> @ I <sub>PP</sub> (Note 6)		∅V <sub>BR</sub> mV/°C
				V <sub>BR</sub> (Note 4) (V)			@ I <sub>T</sub>	V <sub>C</sub>	I <sub>PP</sub>	
				Min	Nom	Max	mA	V	A	
MMBZ16VTALT1G	16T	13	50	15.68	16	16.32	1.0	23	1.7	13.8
MMBZ47VTALT1G**	47T	38	50	46.06	47	47.94	1.0	54	0.74	42.3

4. V<sub>BR</sub> measured at pulse test current I<sub>T</sub> at an ambient temperature of 25°C.

5. Z<sub>ZT</sub> and Z<sub>ZK</sub> are measured by dividing the AC voltage drop across the device by the AC current applied. The specified limits are for I<sub>Z(AC)</sub> = 0.1 I<sub>Z(DC)</sub>, with the AC frequency = 1.0 kHz.

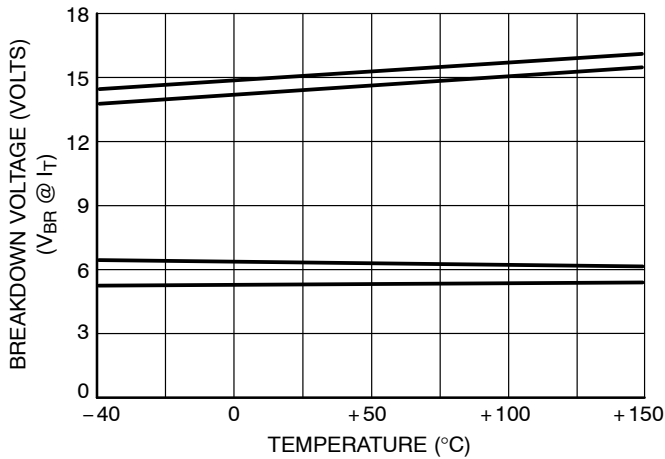
6. Surge current waveform per Figure 6 and derate per Figure 7

\* Include SZ-prefix devices where applicable.

\*\*In development. Contact local sales rep for availability.

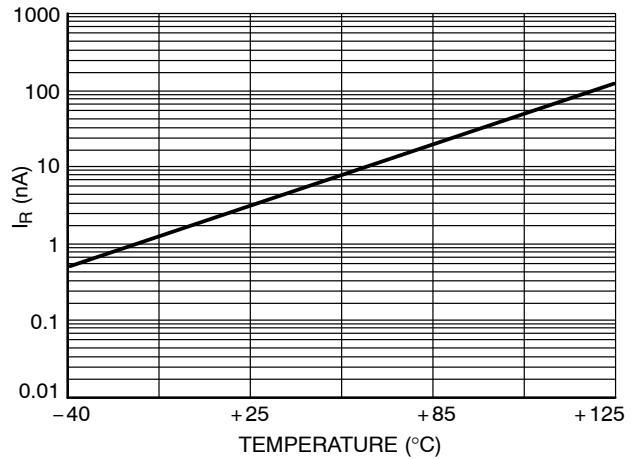
# MMBZxxxALT1G Series, SZMMBZxxxALT1G Series

## TYPICAL CHARACTERISTICS

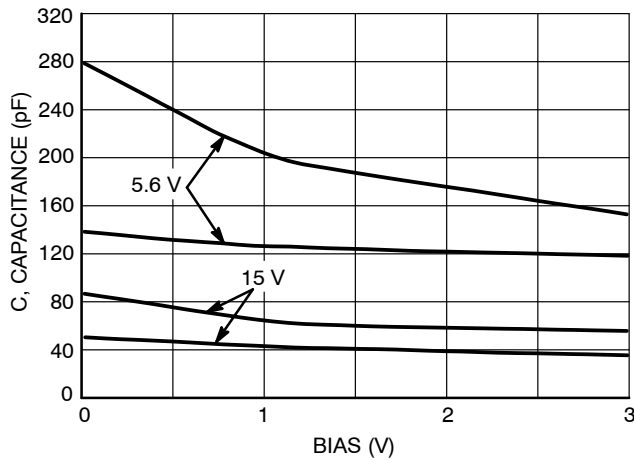


**Figure 1. Typical Breakdown Voltage versus Temperature**

(Upper curve for each voltage is bidirectional mode, lower curve is unidirectional mode)

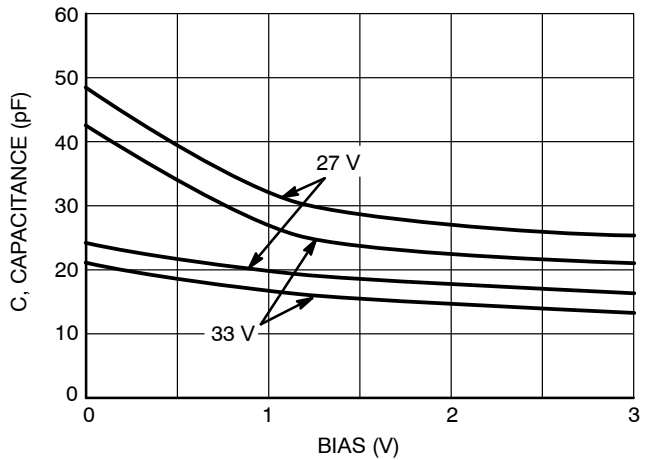


**Figure 2. Typical Leakage Current versus Temperature**



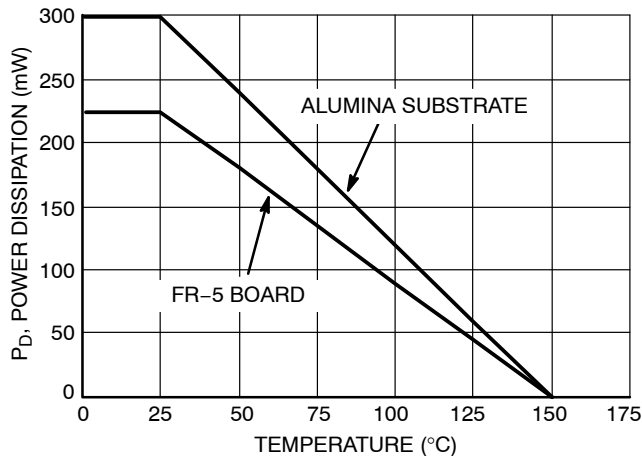
**Figure 3. Typical Capacitance versus Bias Voltage**

(Upper curve for each voltage is unidirectional mode, lower curve is bidirectional mode)



**Figure 4. Typical Capacitance versus Bias Voltage**

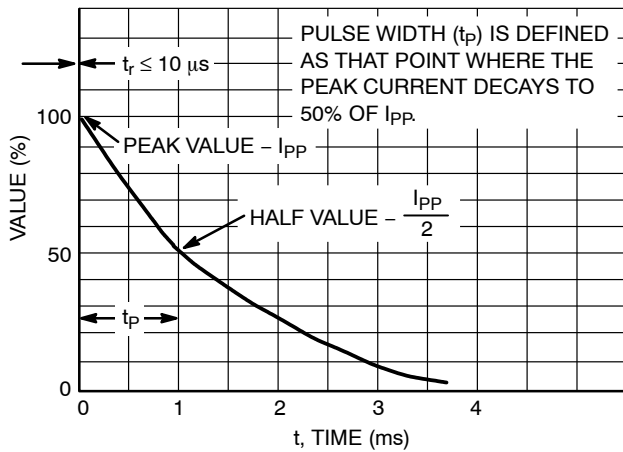
(Upper curve for each voltage is unidirectional mode, lower curve is bidirectional mode)



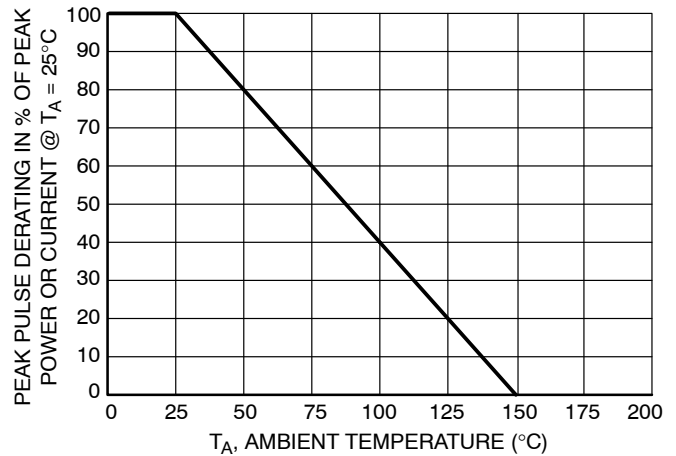
**Figure 5. Steady State Power Derating Curve**

# MMBZxxxALT1G Series, SZMMBZxxxALT1G Series

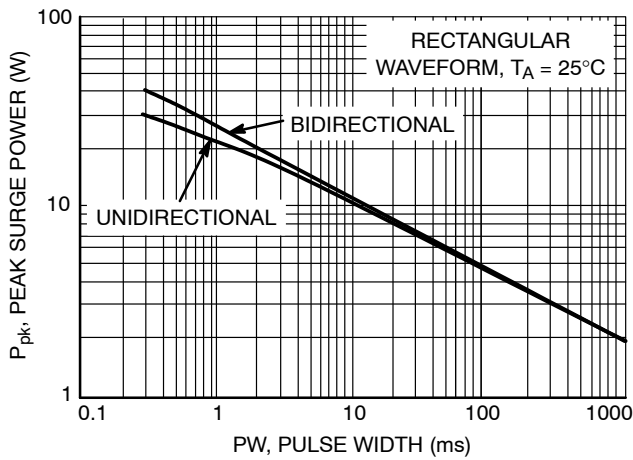
## TYPICAL CHARACTERISTICS



**Figure 6. Pulse Waveform**

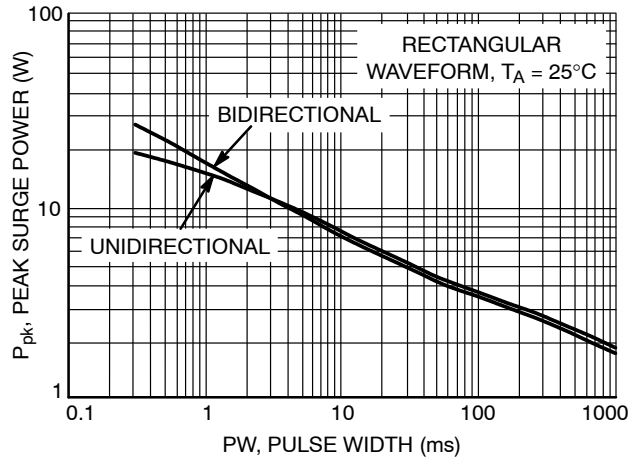


**Figure 7. Pulse Derating Curve**



**Figure 8. Maximum Non-repetitive Surge Power,  $P_{pk}$  versus PW**

Power is defined as  $V_{RSM} \times I_{Z(pk)}$  where  $V_{RSM}$  is the clamping voltage at  $I_{Z(pk)}$ .



**Figure 9. Maximum Non-repetitive Surge Power,  $P_{pk(NOM)}$  versus PW**

Power is defined as  $V_Z(NOM) \times I_{Z(pk)}$  where  $V_Z(NOM)$  is the nominal Zener voltage measured at the low test current used for voltage classification.

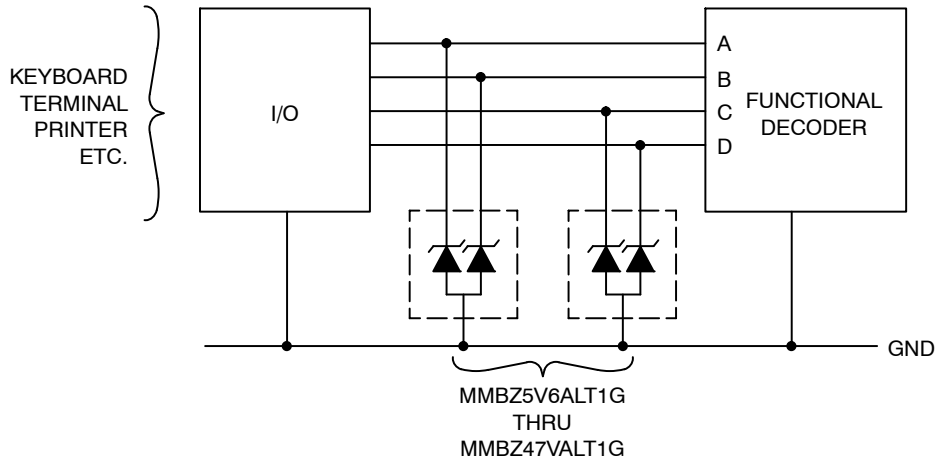
# MMBZxxxALT1G Series, SZMMBZxxxALT1G Series

## TYPICAL COMMON ANODE APPLICATIONS

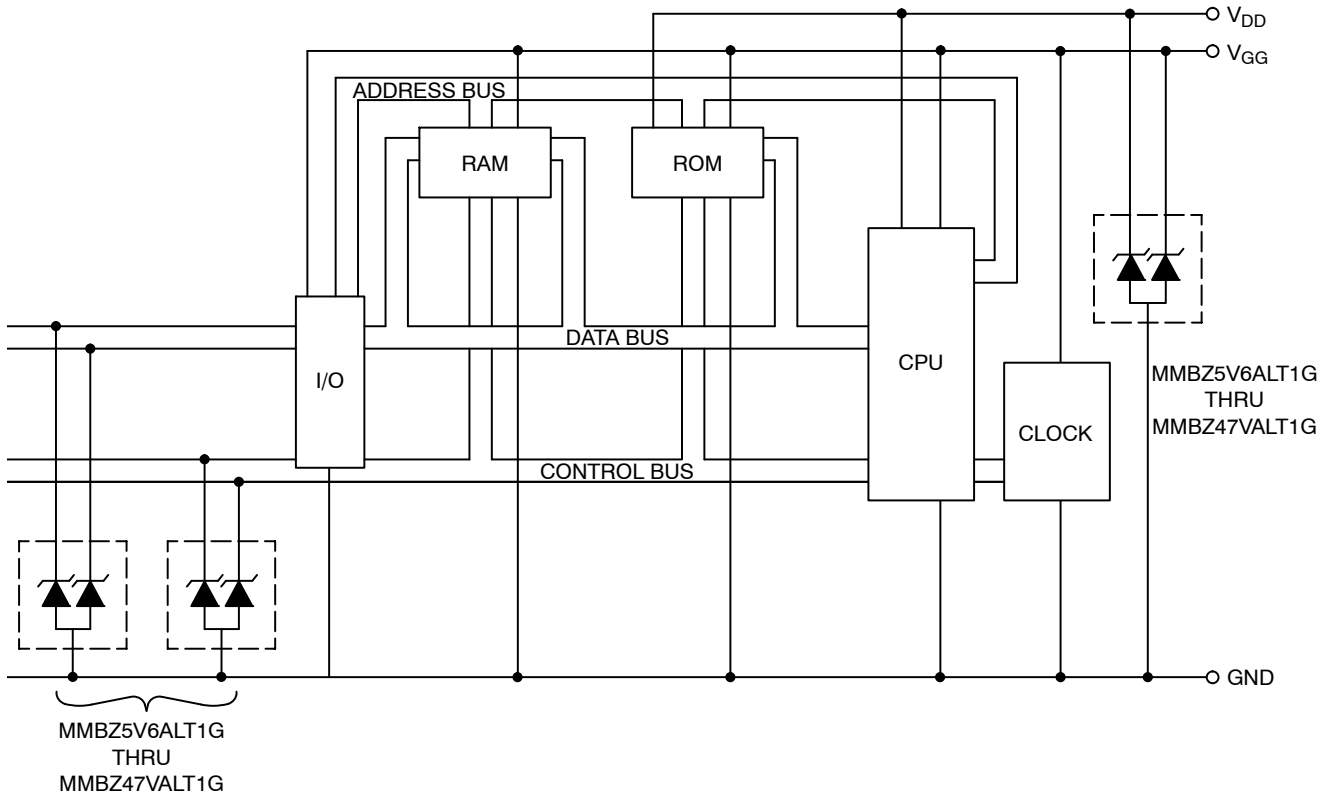
A dual junction common anode design in a SOT-23 package protects two separate lines using only one package. This adds flexibility and creativity to PCB design especially

when board space is at a premium. Two simplified examples of TVS applications are illustrated below.

### Computer Interface Protection



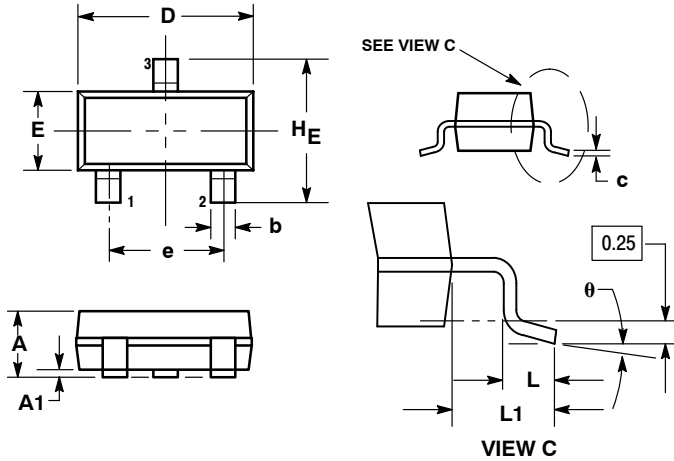
### Microprocessor Protection



# MMBZxxxALT1G Series, SZMMBZxxxALT1G Series

## PACKAGE DIMENSIONS

SOT-23 (TO-236)  
CASE 318-08  
ISSUE AP

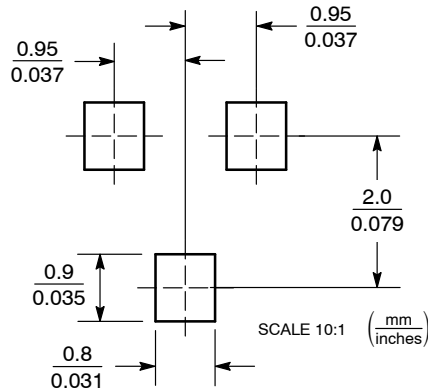


- NOTES:
1. DIMENSIONING AND TOLERANCING PER ANSI Y14.5M, 1982.
  2. CONTROLLING DIMENSION: INCH.
  3. MAXIMUM LEAD THICKNESS INCLUDES LEAD FINISH THICKNESS. MINIMUM LEAD THICKNESS IS THE MINIMUM THICKNESS OF BASE MATERIAL.
  4. DIMENSIONS D AND E DO NOT INCLUDE MOLD FLASH, PROTRUSIONS, OR GATE BURRS.

DIM	MILLIMETERS			INCHES		
	MIN	NOM	MAX	MIN	NOM	MAX
A	0.89	1.00	1.11	0.035	0.040	0.044
A1	0.01	0.06	0.10	0.001	0.002	0.004
b	0.37	0.44	0.50	0.015	0.018	0.020
c	0.09	0.13	0.18	0.003	0.005	0.007
D	2.80	2.90	3.04	0.110	0.114	0.120
E	1.20	1.30	1.40	0.047	0.051	0.055
e	1.78	1.90	2.04	0.070	0.075	0.081
L	0.10	0.20	0.30	0.004	0.008	0.012
L1	0.35	0.54	0.69	0.014	0.021	0.029
HE	2.10	2.40	2.64	0.083	0.094	0.104
θ	0°	---	10°	0°	---	10°

STYLE 12:  
PIN 1. CATHODE  
2. CATHODE  
3. ANODE

## SOLDERING FOOTPRINT



\*For additional information on our Pb-Free strategy and soldering details, please download the ON Semiconductor Soldering and Mounting Techniques Reference Manual, SOLDERRM/D.

ON Semiconductor and the are registered trademarks of Semiconductor Components Industries, LLC (SCILLC) or its subsidiaries in the United States and/or other countries. SCILLC owns the rights to a number of patents, trademarks, copyrights, trade secrets, and other intellectual property. A listing of SCILLC's product/patent coverage may be accessed at [www.onsemi.com/site/pdf/Patent-Marking.pdf](http://www.onsemi.com/site/pdf/Patent-Marking.pdf). SCILLC reserves the right to make changes without further notice to any products herein. SCILLC makes no warranty, representation or guarantee regarding the suitability of its products for any particular purpose, nor does SCILLC assume any liability arising out of the application or use of any product or circuit, and specifically disclaims any and all liability, including without limitation special, consequential or incidental damages. "Typical" parameters which may be provided in SCILLC data sheets and/or specifications can and do vary in different applications and actual performance may vary over time. All operating parameters, including "Typicals" must be validated for each customer application by customer's technical experts. SCILLC does not convey any license under its patent rights nor the rights of others. SCILLC products are not designed, intended, or authorized for use as components in systems intended for surgical implant into the body, or other applications intended to support or sustain life, or for any other application in which the failure of the SCILLC product could create a situation where personal injury or death may occur. Should Buyer purchase or use SCILLC products for any such unintended or unauthorized application, Buyer shall indemnify and hold SCILLC and its officers, employees, subsidiaries, affiliates, and distributors harmless against all claims, costs, damages, and expenses, and reasonable attorney fees arising out of, directly or indirectly, any claim of personal injury or death associated with such unintended or unauthorized use, even if such claim alleges that SCILLC was negligent regarding the design or manufacture of the part. SCILLC is an Equal Opportunity/Affirmative Action Employer. This literature is subject to all applicable copyright laws and is not for resale in any manner.

## PUBLICATION ORDERING INFORMATION

**LITERATURE FULFILLMENT:**  
Literature Distribution Center for ON Semiconductor  
P.O. Box 5163, Denver, Colorado 80217 USA  
**Phone:** 303-675-2175 or 800-344-3860 Toll Free USA/Canada  
**Fax:** 303-675-2176 or 800-344-3867 Toll Free USA/Canada  
**Email:** [orderlit@onsemi.com](mailto:orderlit@onsemi.com)

**N. American Technical Support:** 800-282-9855 Toll Free  
USA/Canada  
**Europe, Middle East and Africa Technical Support:**  
Phone: 421 33 790 2910  
**Japan Customer Focus Center**  
Phone: 81-3-5817-1050

**ON Semiconductor Website:** [www.onsemi.com](http://www.onsemi.com)  
**Order Literature:** <http://www.onsemi.com/orderlit>

For additional information, please contact your local Sales Representative