

LMV793/LMV794 88 MHz, Low Noise, 1.8V CMOS Input, Decompensated Operational Amplifiers

 Check for Samples: [LMV793](#), [LMV794](#)

FEATURES

(Typical 5V Supply, Unless Otherwise Noted)

- **Input Referred Voltage Noise 5.8 nV/ $\sqrt{\text{Hz}}$**
- **Input Bias Current 100 fA**
- **Gain Bandwidth Product 88 MHz**
- **Supply Current per Channel**
 - LMV793 1.15 mA
 - LMV794 1.30 mA
- **Rail-to-Rail Output Swing**
 - @ 10 k Ω Load 25 mV from Rail
 - @ 2 k Ω Load 45 mV from Rail
- **Ensured 2.5V and 5.0V Performance**
- **Total Harmonic Distortion 0.04% @1 kHz, 600 Ω**
- **Temperature Range –40°C to 125°C**

APPLICATIONS

- **ADC Interface**
- **Photodiode Amplifiers**
- **Active Filters and Buffers**
- **Low Noise Signal Processing**
- **Medical Instrumentation**
- **Sensor Interface Applications**

Typical Application

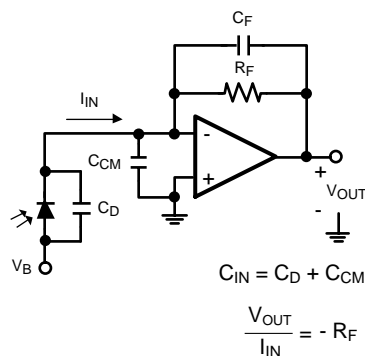

Figure 1. Photodiode Transimpedance Amplifier

DESCRIPTION

The LMV793 (single) and the LMV794 (dual) CMOS input operational amplifiers offer a low input voltage noise density of 5.8 nV/ $\sqrt{\text{Hz}}$ while consuming only 1.15 mA (LMV793) of quiescent current. The LMV793/LMV794 are stable at a gain of 10 and have a gain bandwidth product (GBW) of 88 MHz. The LMV793/LMV794 have a supply voltage range of 1.8V to 5.5V and can operate from a single supply. The LMV793/LMV794 each feature a rail-to-rail output stage capable of driving a 600 Ω load and sourcing as much as 60 mA of current.

The LMV793/LMV794 provide optimal performance in low voltage and low noise systems. A CMOS input stage, with typical input bias currents in the range of a few femto-Amperes, and an input common mode voltage range, which includes ground, make the LMV793/LMV794 ideal for low power sensor applications where high speeds are needed.

The LMV793/LMV794 are manufactured using TI's advanced VIP50 process. The LMV793 is offered in either a 5-Pin SOT23 or an 8-Pin SOIC package. The LMV794 is offered in either the 8-Pin SOIC or the 8-Pin VSSOP.

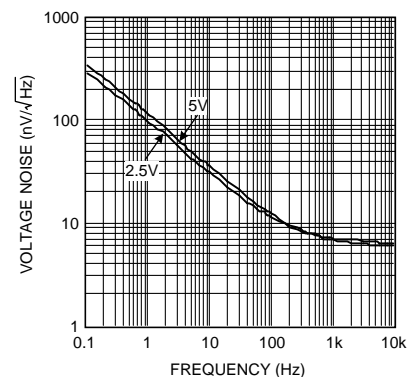

Figure 2. Input Referred Voltage Noise vs. Frequency



Please be aware that an important notice concerning availability, standard warranty, and use in critical applications of Texas Instruments semiconductor products and disclaimers thereto appears at the end of this data sheet.

All trademarks are the property of their respective owners.

PRODUCTION DATA information is current as of publication date. Products conform to specifications per the terms of the Texas Instruments standard warranty. Production processing does not necessarily include testing of all parameters.

Copyright © 2007–2013, Texas Instruments Incorporated



These devices have limited built-in ESD protection. The leads should be shorted together or the device placed in conductive foam during storage or handling to prevent electrostatic damage to the MOS gates.

Absolute Maximum Ratings⁽¹⁾⁽²⁾

| | | |
|-------------------------------------|-----------------------------------|------------------------|
| ESD Tolerance ⁽³⁾ | Human Body Model | 2000V |
| | Machine Model | 200V |
| | Charge-Device Model | 1000V |
| V_{IN} Differential | | ±0.3V |
| Supply Voltage ($V^+ - V^-$) | | 6.0V |
| Input/Output Pin Voltage | | $V^+ +0.3V, V^- -0.3V$ |
| Storage Temperature Range | | -65°C to 150°C |
| Junction Temperature ⁽⁴⁾ | | +150°C |
| Soldering Information | Infrared or Convection (20 sec) | 235°C |
| | Wave Soldering Lead Temp (10 sec) | 260°C |

- (1) Absolute Maximum Ratings indicate limits beyond which damage to the device may occur. Operating Ratings indicate conditions for which the device is intended to be functional, but specific performance is not ensured. For ensured specifications and the test conditions, see the Electrical Characteristics Tables.
- (2) If Military/Aerospace specified devices are required, please contact the Texas Instruments Sales Office/Distributors for availability and specifications.
- (3) Human Body Model, applicable std. MIL-STD-883, Method 3015.7. Machine Model, applicable std. JESD22-A115-A (ESD MM std. of JEDEC) Field-Induced Charge-Device Model, applicable std. JESD22-C101-C (ESD FICDM std. of JEDEC).
- (4) The maximum power dissipation is a function of $T_{J(MAX)}$, θ_{JA} . The maximum allowable power dissipation at any ambient temperature is $P_D = (T_{J(MAX)} - T_A)/\theta_{JA}$. All numbers apply for packages soldered directly onto a PC Board.

Operating Ratings⁽¹⁾

| | | |
|---|---|----------------|
| Temperature Range ⁽²⁾ | | -40°C to 125°C |
| Supply Voltage ($V^+ - V^-$) | $-40^\circ\text{C} \leq T_A \leq 125^\circ\text{C}$ | 2.0V to 5.5V |
| | $0^\circ\text{C} \leq T_A \leq 125^\circ\text{C}$ | 1.8V to 5.5V |
| Package Thermal Resistance (θ_{JA}) ⁽²⁾ | 5-Pin SOT-23 | 180°C/W |
| | 8-Pin SOIC | 190°C/W |
| | 8-Pin VSSOP | 236°C/W |

- (1) Absolute Maximum Ratings indicate limits beyond which damage to the device may occur. Operating Ratings indicate conditions for which the device is intended to be functional, but specific performance is not ensured. For ensured specifications and the test conditions, see the Electrical Characteristics Tables.
- (2) The maximum power dissipation is a function of $T_{J(MAX)}$, θ_{JA} . The maximum allowable power dissipation at any ambient temperature is $P_D = (T_{J(MAX)} - T_A)/\theta_{JA}$. All numbers apply for packages soldered directly onto a PC Board.

2.5V Electrical Characteristics⁽¹⁾

Unless otherwise specified, all limits are specified for $T_A = 25^\circ\text{C}$, $V^+ = 2.5\text{V}$, $V^- = 0\text{V}$, $V_{CM} = V^+/2 = V_O$. **Boldface** limits apply at the temperature extremes.

| Symbol | Parameter | Conditions | Min (2) | Typ (3) | Max (2) | Units |
|-------------|---|------------|------------|------------|----------------|-------|
| V_{OS} | Input Offset Voltage | | | 0.1 | ±1.35 ±1.65 | mV |
| TC V_{OS} | Input Offset Voltage Temperature Drift ⁽⁴⁾ | LMV793 | | -1.0 | | µV/°C |
| | | LMV794 | | -1.8 | | |

- (1) Electrical Table values apply only for factory testing conditions at the temperature indicated. Factory testing conditions result in very limited self-heating of the device such that $T_J = T_A$. No specification of parametric performance is indicated in the electrical tables under conditions of internal self-heating where $T_J > T_A$.
- (2) Limits are 100% production tested at 25°C. Limits over the operating temperature range are specified through correlations using the statistical quality control (SQC) method.
- (3) Typical values represent the most likely parametric norm as determined at the time of characterization. Actual typical values may vary over time and will also depend on the application and configuration. The typical values are not tested and are not ensured on shipped production material.
- (4) Offset voltage average drift is determined by dividing the change in V_{OS} by temperature change.

2.5V Electrical Characteristics⁽¹⁾ (continued)

Unless otherwise specified, all limits are specified for $T_A = 25^\circ\text{C}$, $V^+ = 2.5\text{V}$, $V^- = 0\text{V}$, $V_{\text{CM}} = V^+/2 = V_O$. **Boldface** limits apply at the temperature extremes.

| Symbol | Parameter | Conditions | Min (2) | Typ (3) | Max (2) | Units |
|------------------|--------------------------------------|--|---|-----------------|---------------------|------------------------|
| I_B | Input Bias Current | $V_{\text{CM}} = 1.0\text{V}^{(5) (6)}$ | $-40^\circ\text{C} \leq T_A \leq 85^\circ\text{C}$ | 0.05 | 1 25 | pA |
| | | | $-40^\circ\text{C} \leq T_A \leq 125^\circ\text{C}$ | | 0.05 | |
| I_{OS} | Input Offset Current | $V_{\text{CM}} = 1.0\text{V}^{(6)}$ | | 10 | | fA |
| CMRR | Common Mode Rejection Ratio | $0\text{V} \leq V_{\text{CM}} \leq 1.4\text{V}$ | 80 75 | 94 | | dB |
| PSRR | Power Supply Rejection Ratio | $2.0\text{V} \leq V^+ \leq 5.5\text{V}$, $V_{\text{CM}} = 0\text{V}$ | 80 75 | 100 | | dB |
| | | $1.8\text{V} \leq V^+ \leq 5.5\text{V}$, $V_{\text{CM}} = 0\text{V}$ | 80 | 98 | | |
| CMVR | Common Mode Voltage Range | CMRR ≥ 60 dB CMRR ≥ 55 dB | -0.3 -0.3 | | 1.5 1.5 | V |
| A_{VOL} | Open Loop Voltage Gain | $V_{\text{OUT}} = 0.15\text{V to } 2.2\text{V}$, $R_L = 2\text{ k}\Omega \text{ to } V^+/2$ | LMV793 | 85 80 | 98 | dB |
| | | | LMV794 | 82 78 | 92 | |
| | | $V_{\text{OUT}} = 0.15\text{V to } 2.2\text{V}$, $R_L = 10\text{ k}\Omega \text{ to } V^+/2$ | | 88 84 | 110 | |
| V_{OUT} | Output Voltage Swing High | $R_L = 2\text{ k}\Omega \text{ to } V^+/2$ | | 25 | 75 82 | mV from either rail |
| | | $R_L = 10\text{ k}\Omega \text{ to } V^+/2$ | | 20 | 65 71 | |
| | Output Voltage Swing Low | $R_L = 2\text{ k}\Omega \text{ to } V^+/2$ | | 30 | 75 78 | |
| | | $R_L = 10\text{ k}\Omega \text{ to } V^+/2$ | | 15 | 65 67 | |
| I_{OUT} | Output Current | Sourcing to V^- $V_{\text{IN}} = 200\text{ mV}^{(7)}$ | 35 28 | 47 | | mA |
| | | Sinking to V^+ $V_{\text{IN}} = -200\text{ mV}^{(7)}$ | 7 5 | 15 | | |
| I_S | Supply Current Per Amplifier | LMV793 | | 0.95 | 1.30 1.65 | mA |
| | | LMV794 | | 1.1 | 1.50 1.85 | |
| SR | Slew Rate | $A_V = +10$, Rising (10% to 90%) | | 32 | | V/ μs |
| | | $A_V = +10$, Falling (90% to 10%) | | 24 | | |
| GBW | Gain Bandwidth | $A_V = +10$, $R_L = 10\text{ k}\Omega$ | | 88 | | MHz |
| e_n | Input Referred Voltage Noise Density | $f = 1\text{ kHz}$ | | 6.2 | | nV/ $\sqrt{\text{Hz}}$ |
| i_n | Input Referred Current Noise Density | $f = 1\text{ kHz}$ | | 0.01 | | pA/ $\sqrt{\text{Hz}}$ |
| THD+N | Total Harmonic Distortion + Noise | $f = 1\text{ kHz}$, $A_V = 1$, $R_L = 600\Omega$ | | 0.01 | | % |

(5) Positive current corresponds to current flowing into the device.

(6) This parameter is specified by design and/or characterization and is not tested in production.

(7) The short circuit test is a momentary test, the short circuit duration is 1.5 ms.

5V Electrical Characteristics⁽¹⁾

Unless otherwise specified, all limits are specified for $T_A = 25^\circ\text{C}$, $V^+ = 5\text{V}$, $V^- = 0\text{V}$, $V_{\text{CM}} = V^+/2 = V_O$. **Boldface** limits apply at the temperature extremes.

| Symbol | Parameter | Conditions | Min (2) | Typ (3) | Max (2) | Units | |
|----------------------------|---|--|---|-----------------|--|------------------------------|---------------------|
| V_{OS} | Input Offset Voltage | | | 0.1 | ± 1.35 ± 1.65 | mV | |
| $\text{TC } V_{\text{OS}}$ | Input Offset Voltage Temperature Drift ⁽⁴⁾ | LMV793 | | -1.0 | | $\mu\text{V}/^\circ\text{C}$ | |
| | | LMV794 | | -1.8 | | | |
| I_B | Input Bias Current | $V_{\text{CM}} = 2.0\text{V}$ ^{(5) (6)} $-40^\circ\text{C} \leq T_A \leq 85^\circ\text{C}$ | | 0.1 | 1 25 | μA | |
| | | | $-40^\circ\text{C} \leq T_A \leq 125^\circ\text{C}$ | 0.1 | 1 100 | | |
| I_{OS} | Input Offset Current | $V_{\text{CM}} = 2.0\text{V}$ ⁽⁶⁾ | | 10 | | fA | |
| CMRR | Common Mode Rejection Ratio | $0\text{V} \leq V_{\text{CM}} \leq 3.7\text{V}$ | 80 75 | 100 | | dB | |
| PSRR | Power Supply Rejection Ratio | $2.0\text{V} \leq V^+ \leq 5.5\text{V}$, $V_{\text{CM}} = 0\text{V}$ | 80 75 | 100 | | dB | |
| | | $1.8\text{V} \leq V^+ \leq 5.5\text{V}$, $V_{\text{CM}} = 0\text{V}$ | 80 | 98 | | | |
| CMVR | Common Mode Voltage Range | CMRR ≥ 60 dB CMRR ≥ 55 dB | -0.3 -0.3 | | 4 4 | V | |
| A_{VOL} | Open Loop Voltage Gain | $V_{\text{OUT}} = 0.3\text{V}$ to 4.7V , $R_L = 2\text{ k}\Omega$ to $V^+/2$ | LMV793 | 85 80 | 97 | dB | |
| | | | LMV794 | 82 78 | 89 | | |
| | | $V_{\text{OUT}} = 0.3\text{V}$ to 4.7V , $R_L = 10\text{ k}\Omega$ to $V^+/2$ | | 88 84 | 110 | | |
| V_{OUT} | Output Voltage Swing High | $R_L = 2\text{ k}\Omega$ to $V^+/2$ | LMV793 | | 35 | 75 82 | mV from either rail |
| | | | LMV794 | | 35 | 75 82 | |
| | | $R_L = 10\text{ k}\Omega$ to $V^+/2$ | | 25 | 65 71 | | |
| | Output Voltage Swing Low | $R_L = 2\text{ k}\Omega$ to $V^+/2$ | LMV793 | | 42 | 75 78 | |
| | | | LMV794 | | 45 | 80 83 | |
| | | $R_L = 10\text{ k}\Omega$ to $V^+/2$ | | 20 | 65 67 | | |
| I_{OUT} | Output Current | Sourcing to V^- $V_{\text{IN}} = 200\text{ mV}$ ⁽⁷⁾ | 45 37 | 60 | | mA | |
| | | Sinking to V^+ $V_{\text{IN}} = -200\text{ mV}$ ⁽⁷⁾ | 10 6 | 21 | | | |
| I_S | Supply Current per Amplifier | LMV793 | | 1.15 | 1.40 1.75 | mA | |
| | | LMV794 per Channel | | 1.30 | 1.70 2.05 | | |

- (1) Electrical Table values apply only for factory testing conditions at the temperature indicated. Factory testing conditions result in very limited self-heating of the device such that $T_J = T_A$. No specification of parametric performance is indicated in the electrical tables under conditions of internal self-heating where $T_J > T_A$.
- (2) Limits are 100% production tested at 25°C . Limits over the operating temperature range are specified through correlations using the statistical quality control (SQC) method.
- (3) Typical values represent the most likely parametric norm as determined at the time of characterization. Actual typical values may vary over time and will also depend on the application and configuration. The typical values are not tested and are not ensured on shipped production material.
- (4) Offset voltage average drift is determined by dividing the change in V_{OS} by temperature change.
- (5) Positive current corresponds to current flowing into the device.
- (6) This parameter is specified by design and/or characterization and is not tested in production.
- (7) The short circuit test is a momentary test, the short circuit duration is 1.5 ms.

5V Electrical Characteristics⁽¹⁾ (continued)

Unless otherwise specified, all limits are specified for $T_A = 25^\circ\text{C}$, $V^+ = 5\text{V}$, $V^- = 0\text{V}$, $V_{\text{CM}} = V^+/2 = V_O$. **Boldface** limits apply at the temperature extremes.

| Symbol | Parameter | Conditions | Min (2) | Typ (3) | Max (2) | Units |
|--------|--------------------------------------|--|---------|---------|---------|------------------------|
| SR | Slew Rate | $A_V = +10$, Rising (10% to 90%) | | 35 | | V/ μs |
| | | $A_V = +10$, Falling (90% to 10%) | | 28 | | |
| GBW | Gain Bandwidth | $A_V = +10$, $R_L = 10\text{ k}\Omega$ | | 88 | | MHz |
| e_n | Input Referred Voltage Noise Density | $f = 1\text{ kHz}$ | | 5.8 | | nV/ $\sqrt{\text{Hz}}$ |
| i_n | Input Referred Current Noise Density | $f = 1\text{ kHz}$ | | 0.01 | | pA/ $\sqrt{\text{Hz}}$ |
| THD+N | Total Harmonic Distortion + Noise | $f = 1\text{ kHz}$, $A_V = 1$, $R_L = 600\Omega$ | | 0.01 | | % |

Connection Diagram

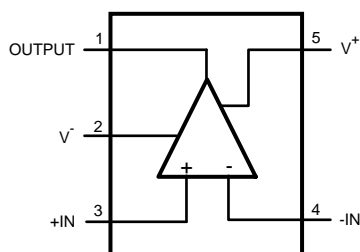

Figure 3. 5-Pin SOT-23 (LMV793) Top View

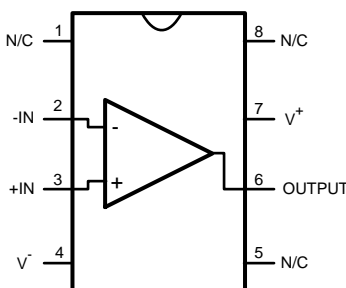

Figure 4. 8-Pin SOIC (LMV793) Top View

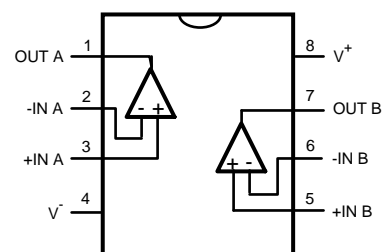

Figure 5. 8-Pin SOIC/VSSOP (LMV794) Top View

Typical Performance Characteristics

Unless otherwise specified, $T_A = 25^\circ\text{C}$, $V^- = 0$, $V^+ = \text{Supply Voltage} = 5\text{V}$, $V_{CM} = V^+/2$.

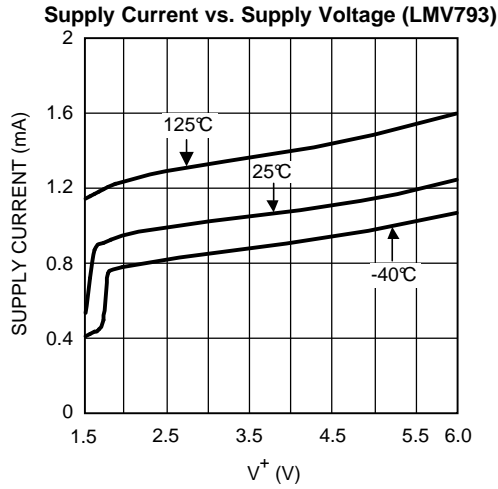

Figure 6.

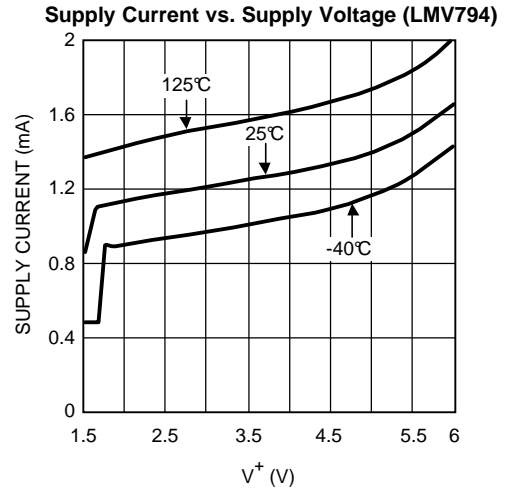

Figure 7.

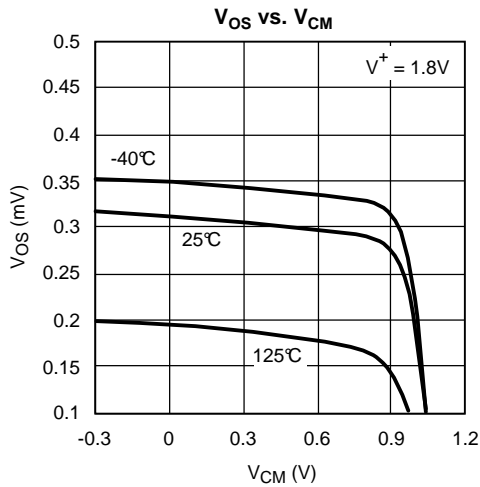

Figure 8.

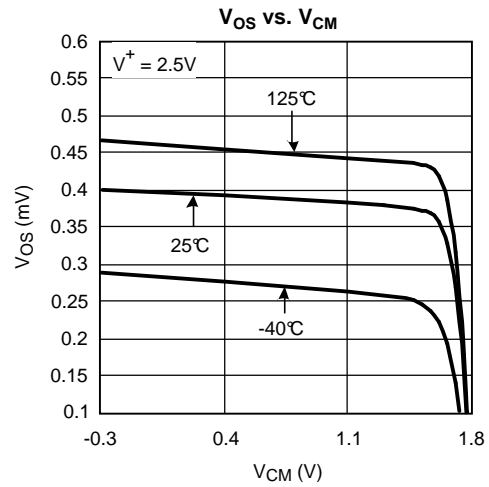

Figure 9.

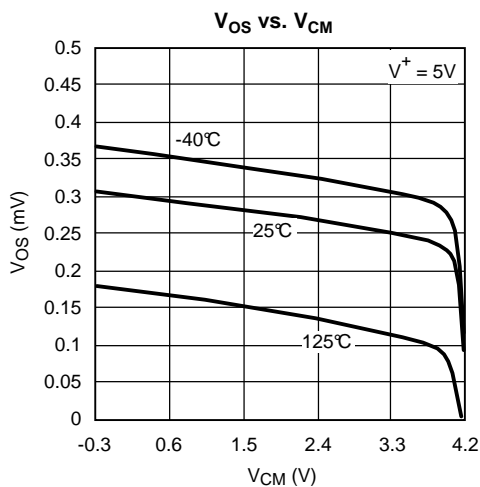

Figure 10.

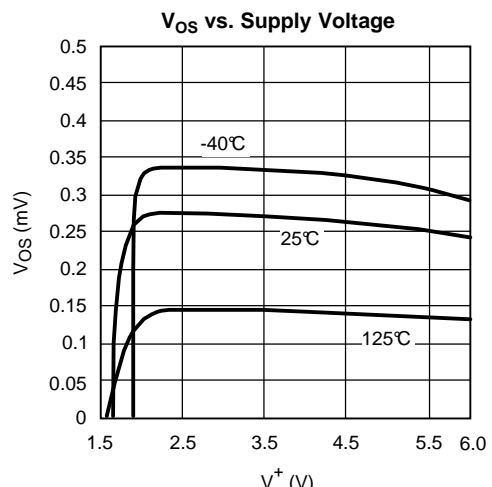

Figure 11.

Typical Performance Characteristics (continued)

Unless otherwise specified, $T_A = 25^\circ\text{C}$, $V^- = 0$, $V^+ = \text{Supply Voltage} = 5\text{V}$, $V_{CM} = V^+/2$.

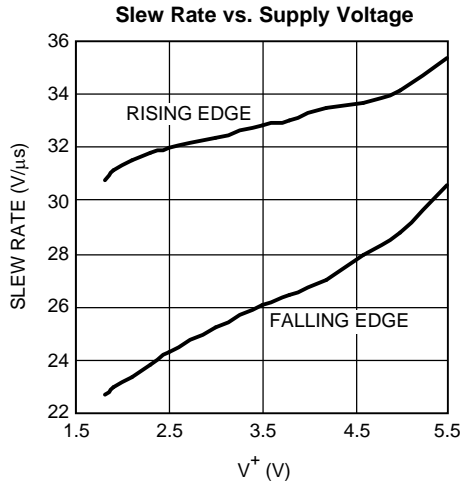

Figure 12.

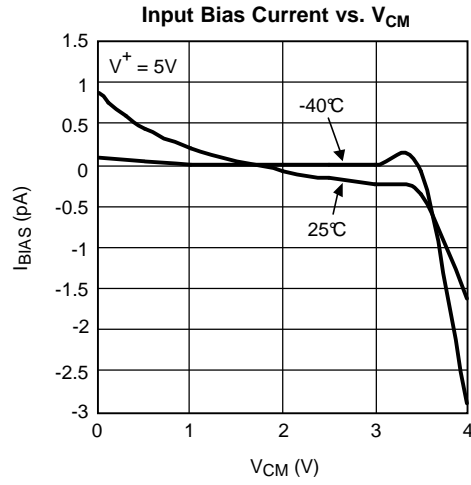

Figure 13.

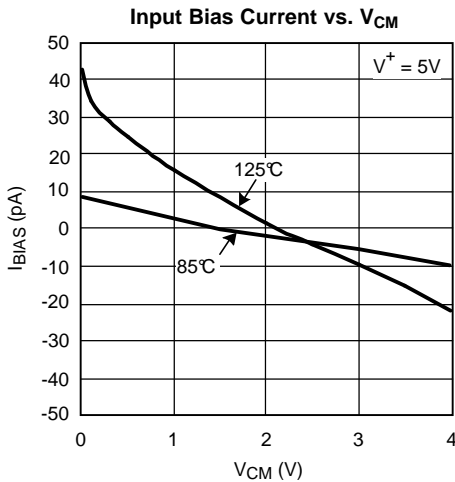

Figure 14.

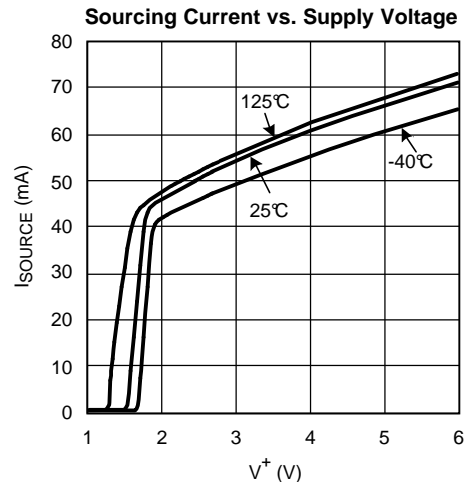

Figure 15.

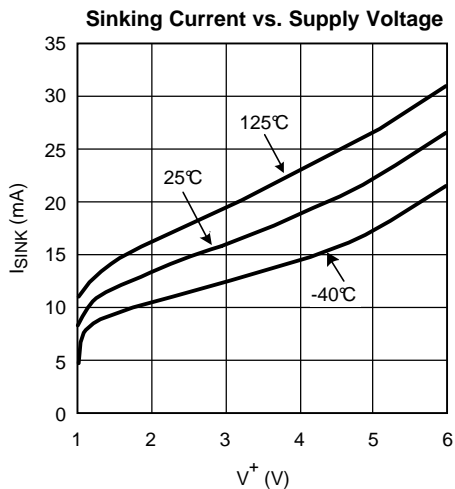

Figure 16.

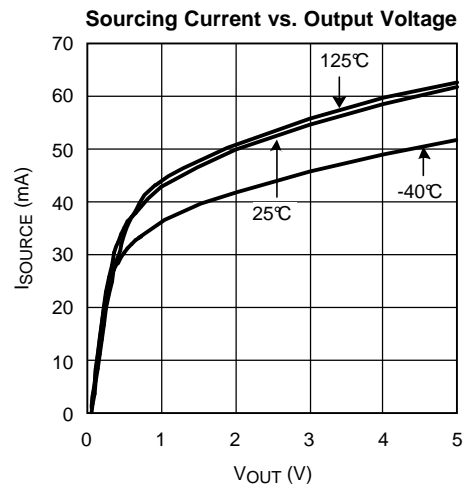

Figure 17.

Typical Performance Characteristics (continued)

Unless otherwise specified, $T_A = 25^\circ\text{C}$, $V^- = 0$, $V^+ = \text{Supply Voltage} = 5\text{V}$, $V_{CM} = V^+/2$.

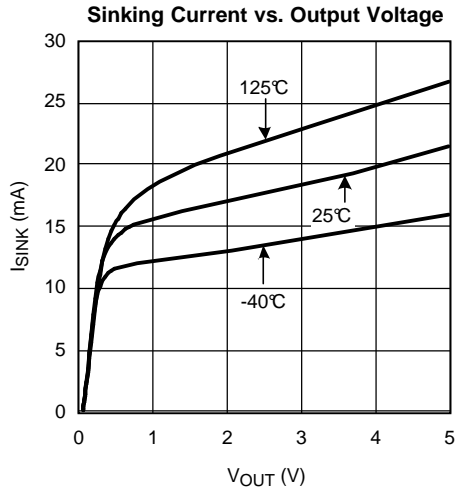

Figure 18.

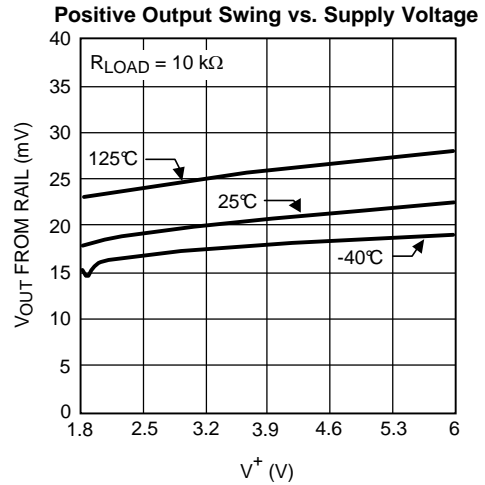

Figure 19.

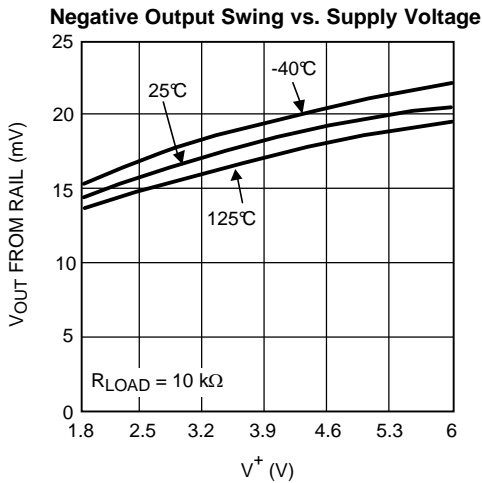

Figure 20.

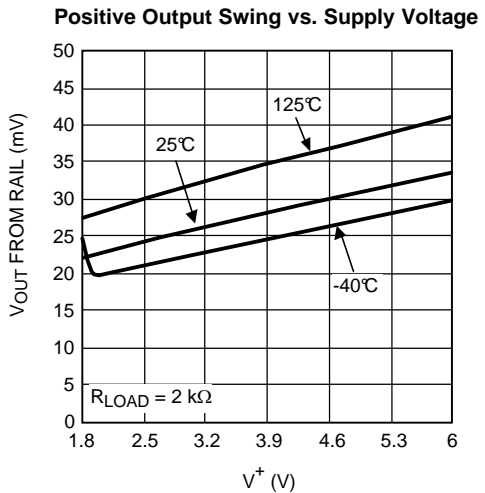

Figure 21.

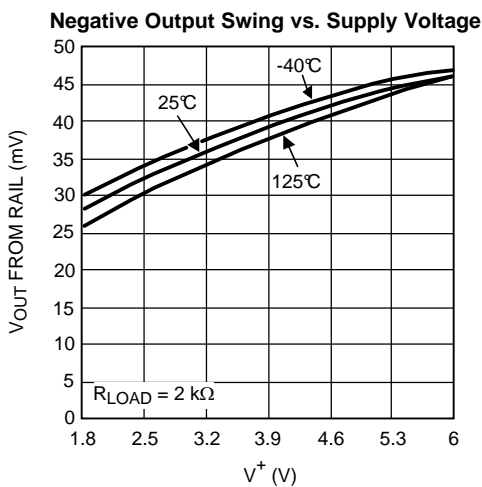

Figure 22.

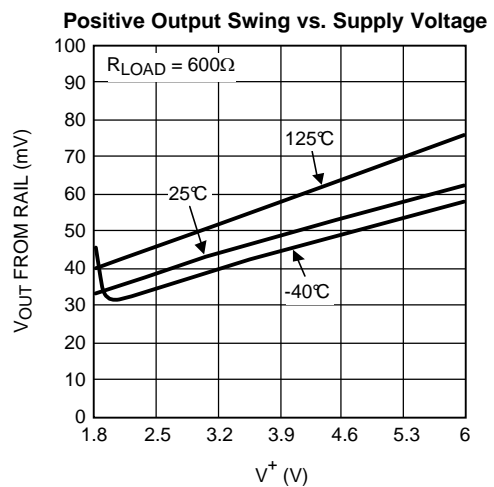

Figure 23.

Typical Performance Characteristics (continued)

Unless otherwise specified, $T_A = 25^\circ\text{C}$, $V^- = 0$, $V^+ = \text{Supply Voltage} = 5\text{V}$, $V_{CM} = V^+/2$.

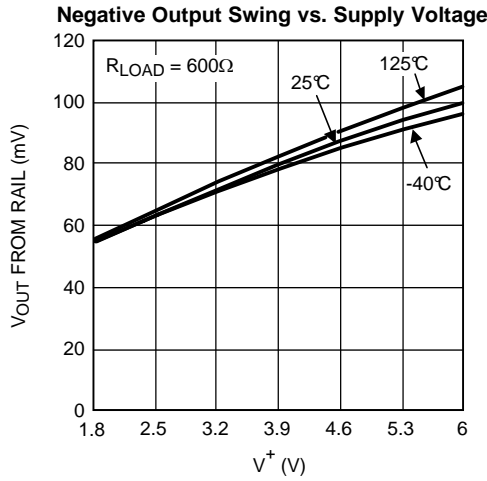

Figure 24.

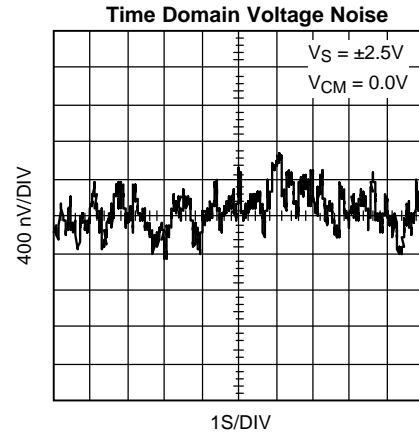

Figure 25.

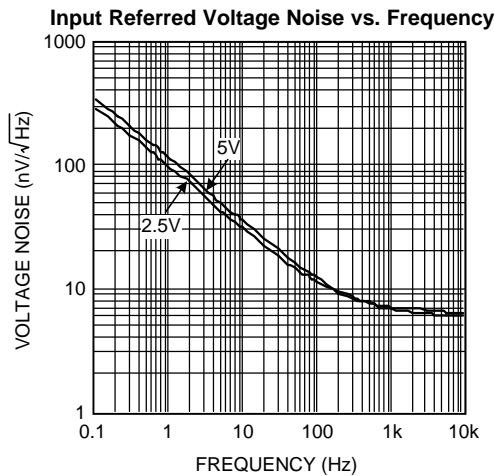

Figure 26.

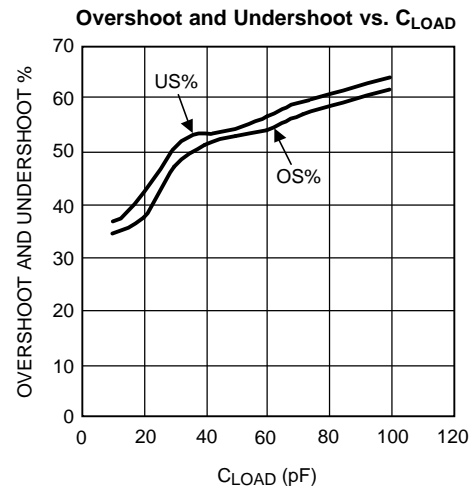

Figure 27.

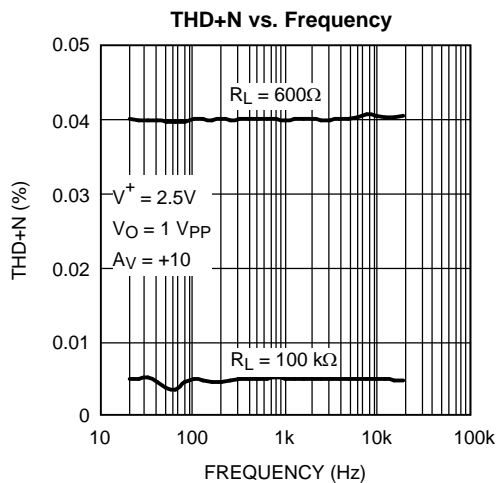

Figure 28.

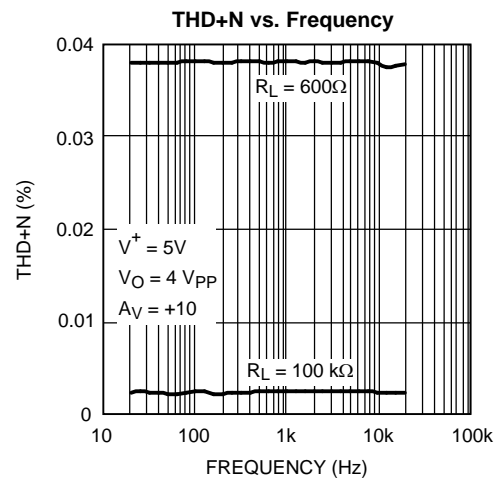

Figure 29.

Typical Performance Characteristics (continued)

Unless otherwise specified, $T_A = 25^\circ\text{C}$, $V^- = 0$, $V^+ = \text{Supply Voltage} = 5\text{V}$, $V_{CM} = V^+/2$.

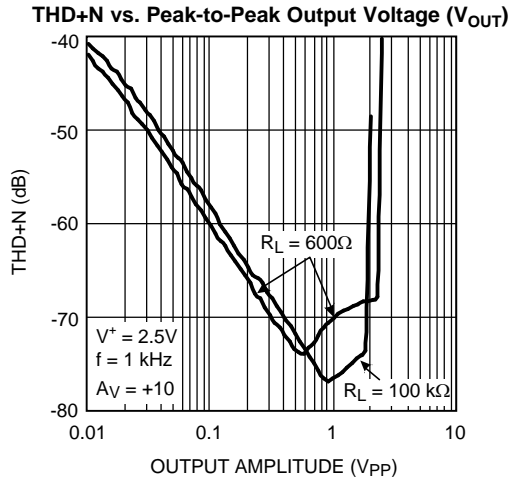

Figure 30.

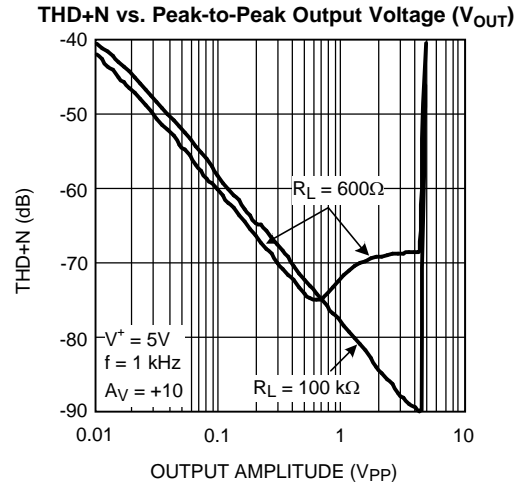

Figure 31.

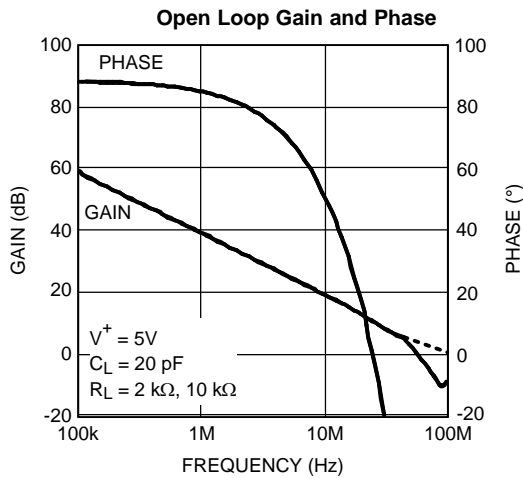

Figure 32.

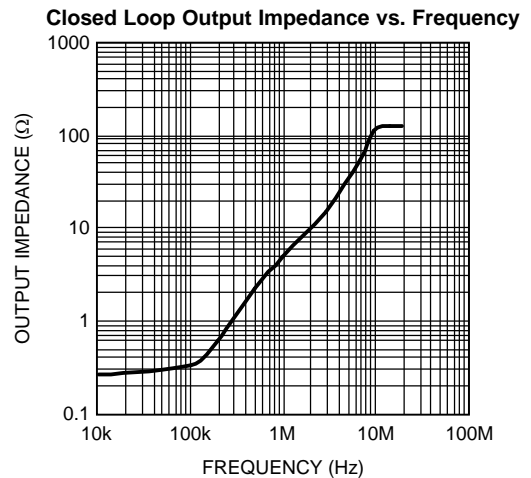

Figure 33.

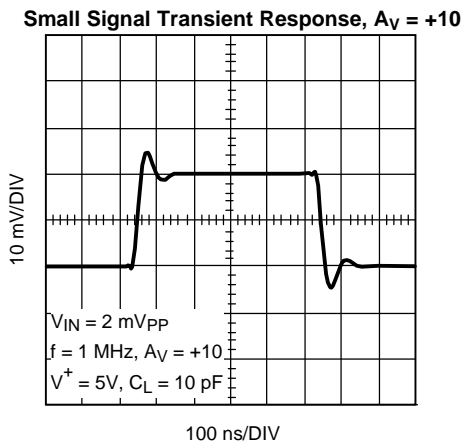

Figure 34.

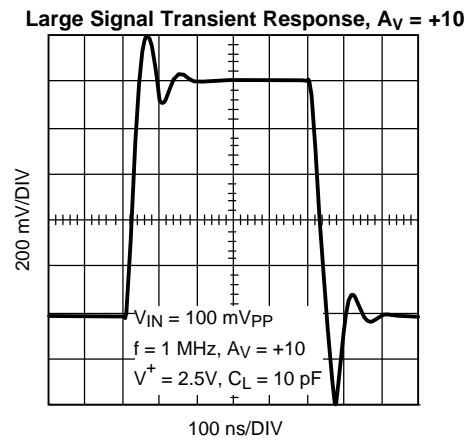
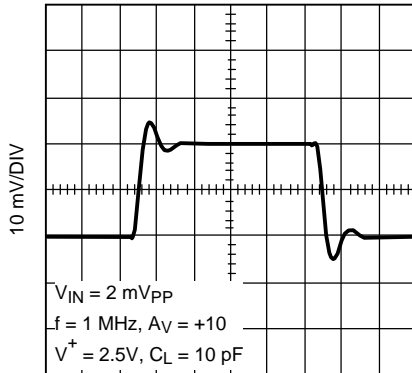

Figure 35.

Typical Performance Characteristics (continued)

Unless otherwise specified, $T_A = 25^\circ\text{C}$, $V^- = 0$, $V^+ = \text{Supply Voltage} = 5\text{V}$, $V_{CM} = V^+/2$.

Small Signal Transient Response, $A_V = +10$



100 ns/DIV
Figure 36.

Large Signal Transient Response, $A_V = +10$

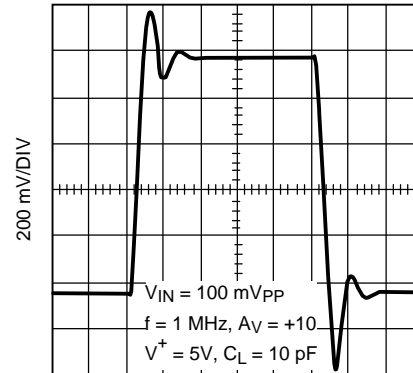

100 ns/DIV
Figure 37.

PSRR vs. Frequency

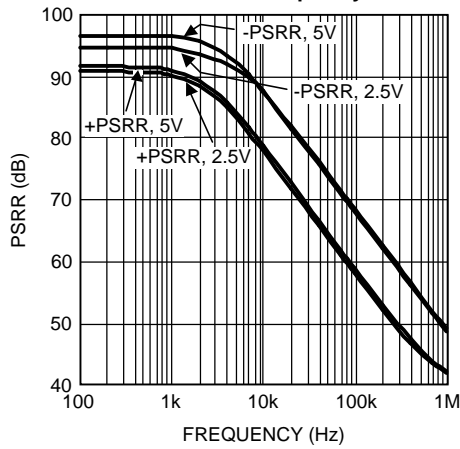

Figure 38.

CMRR vs. Frequency

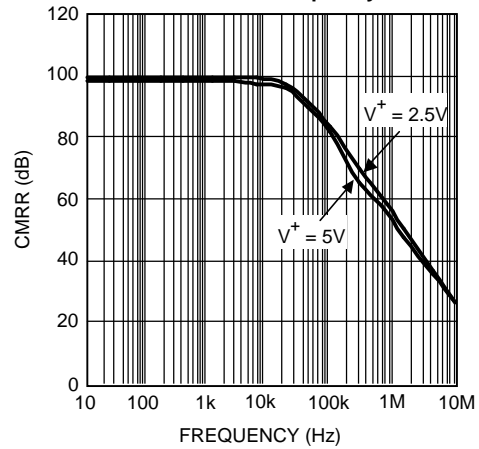

Figure 39.

Input Common Mode Capacitance vs. V_{CM}

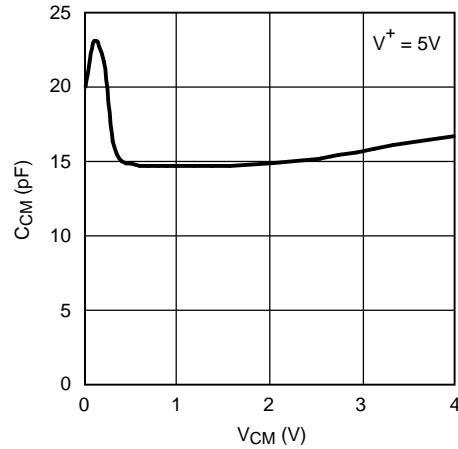

Figure 40.

APPLICATION INFORMATION

ADVANTAGES OF THE LMV793/LMV794

Wide Bandwidth at Low Supply Current

The LMV793/LMV794 are high performance op amps that provide a GBW of 88 MHz with a gain of 10 while drawing a low supply current of 1.15 mA. This makes them ideal for providing wideband amplification in data acquisition applications.

With the proper external compensation the LMV793/LMV794 can be operated at gains of ± 1 and still maintain much faster slew rates than comparable unity gain stable amplifiers. The increase in bandwidth and slew rate is obtained without any additional power consumption over the LMV796.

Low Input Referred Noise and Low Input Bias Current

The LMV793/LMV794 have a very low input referred voltage noise density ($5.8 \text{ nV}/\sqrt{\text{Hz}}$ at 1 kHz). A CMOS input stage ensures a small input bias current (100 fA) and low input referred current noise ($0.01 \text{ pA}/\sqrt{\text{Hz}}$). This is very helpful in maintaining signal integrity, and makes the LMV793/LMV794 ideal for audio and sensor based applications.

Low Supply Voltage

The LMV793 and LMV794 have performance specified at 2.5V and 5V supply. These parts are specified to be operational at all supply voltages between 2.0V and 5.5V, for ambient temperatures ranging from -40°C to 125°C , thus utilizing the entire battery lifetime. The LMV793/LMV794 are also specified to be operational at 1.8V supply voltage, for temperatures between 0°C and 125°C optimizing their usage in low-voltage applications.

RRO and Ground Sensing

Rail-to-rail output swing provides the maximum possible dynamic range. This is particularly important when operating at low supply voltages. An innovative positive feedback scheme is used to boost the current drive capability of the output stage. This allows the LMV793/LMV794 to source more than 40 mA of current at 1.8V supply. This also limits the performance of these parts as comparators, and hence the usage of the LMV793 and the LMV794 in an open-loop configuration is not recommended. The input common-mode range includes the negative supply rail which allows direct sensing at ground in single supply operation.

Small Size

The small footprint of the LMV793 and the LMV794 package saves space on printed circuit boards, and enables the design of smaller electronic products, such as cellular phones, pagers, or other portable systems. Long traces between the signal source and the op amp make the signal path more susceptible to noise pick up.

The physically smaller LMV793/LMV794 packages, allow the op amp to be placed closer to the signal source, thus reducing noise pickup and maintaining signal integrity.

USING THE DECOMPENSATED LMV793

Advantages of Decompensated Op Amps

A unity gain stable op amp, which is fully compensated, is designed to operate with good stability down to gains of ± 1 . The large amount of compensation does provide an op amp that is relatively easy to use; however, a decompensated op amp is designed to maximize the bandwidth and slew rate without any additional power consumption. This can be very advantageous.

The LMV793/LMV794 require a gain of ± 10 to be stable. However, with an external compensation network (a simple RC network) these parts can be stable with gains of ± 1 and still maintain the higher slew rate. Looking at the Bode plots for the LMV793 and its closest equivalent unity gain stable op amp, the LMV796, one can clearly see the increased bandwidth of the LMV793. Both plots are taken with a parallel combination of 20 pF and 10 k Ω for the output load.

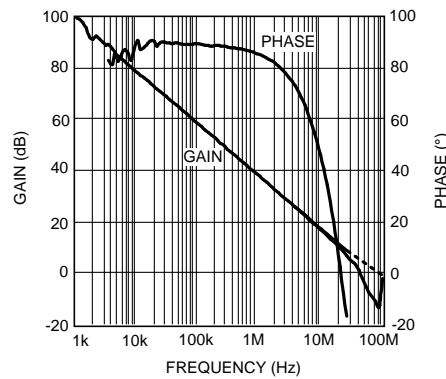

Figure 41. LMV793 A_{VOL} vs. Frequency

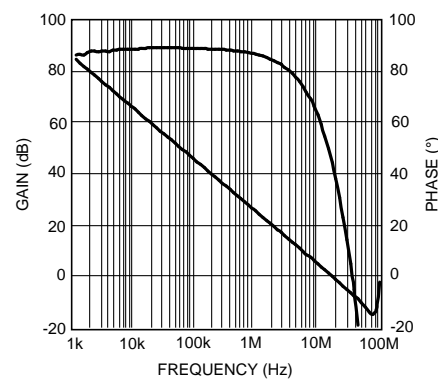

Figure 42. LMV796 A_{VOL} vs. Frequency

Figure 41 shows the much larger 88 MHz bandwidth of the LMV793 as compared to the 17 MHz bandwidth of the LMV796 shown in Figure 42. The decompensated LMV793 has five times the bandwidth of the LMV796.

What is a Decompensated Op Amp?

The differences between the unity gain stable op amp and the decompensated op amp are shown in Figure 43. This Bode plot assumes an ideal two pole system. The dominant pole of the decompensated op amp is at a higher frequency, f_1 , as compared to the unity-gain stable op amp which is at f_d as shown in Figure 43. This is done in order to increase the speed capability of the op amp while maintaining the same power dissipation of the unity gain stable op amp. The LMV793/LMV794 have a dominant pole at 1.6 kHz. The unity gain stable LMV796/LMV797 have their dominant pole at 300 Hz.

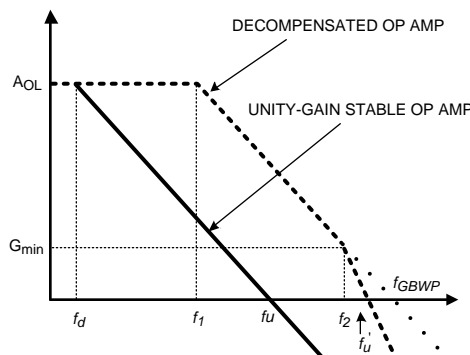

Figure 43. Open Loop Gain for Unity-Gain Stable Op Amp and Decompensated Op Amp

Having a higher frequency for the dominate pole will result in:

1. The DC open-loop gain (A_{VOL}) extending to a higher frequency.
2. A wider closed loop bandwidth.
3. Better slew rate due to reduced compensation capacitance within the op amp.

The second open loop pole (f_2) for the LMV793/LMV794 occurs at 45 MHz. The unity gain (f_u') occurs after the second pole at 51 MHz. An ideal two pole system would give a phase margin of 45° at the location of the second pole. The LMV793/LMV794 have parasitic poles close to the second pole, giving a phase margin closer to 0° . Therefore it is necessary to operate the LMV793/LMV794 at a closed loop gain of 10 or higher, or to add external compensation in order to assure stability.

For the LMV796, the gain bandwidth product occurs at 17 MHz. The curve is constant from f_d to f_u which occurs before the second pole.

For the LMV793/LMV794, the GBW = 88 MHz and is constant between f_1 and f_2 . The second pole at f_2 occurs before $A_{VOL} = 1$. Therefore f_u' occurs at 51 MHz, well before the GBW frequency of 88 MHz. For decompensated op amps the unity gain frequency and the GBW are no longer equal. G_{min} is the minimum gain for stability and for the LMV793/LMV794 this is a gain of 18 to 20 dB.

Input Lead-Lag Compensation

The recommended technique which allows the user to compensate the LMV793/LMV794 for stable operation at any gain is lead-lag compensation. The compensation components added to the circuit allow the user to shape the feedback function to make sure there is sufficient phase margin when the loop gain is as low as 0 dB and still maintain the advantages over the unity gain op amp. Figure 44 shows the lead-lag configuration. Only R_C and C are added for the necessary compensation.

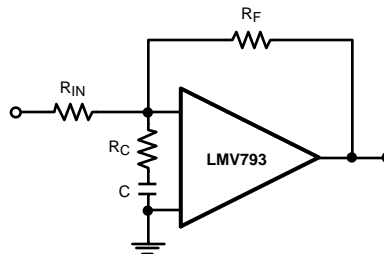

Figure 44. LMV793 with Lead-Lag Compensation for Inverting Configuration

To cover how to calculate the compensation network values it is necessary to introduce the term called the feedback factor or F . The feedback factor F is the feedback voltage $V_A - V_B$ across the op amp input terminals relative to the op amp output voltage V_{OUT} .

$$F = \frac{V_A - V_B}{V_{OUT}} \quad (1)$$

From feedback theory the classic form of the feedback equation for op amps is:

$$\frac{V_{OUT}}{V_{IN}} = \frac{A}{1 + AF} \quad (2)$$

A is the open loop gain of the amplifier and AF is the loop gain. Both are highly important in analyzing op amps. Normally $AF \gg 1$ and so the above equation reduces to:

$$\frac{V_{OUT}}{V_{IN}} = \frac{1}{F} \quad (3)$$

Deriving the equations for the lead-lag compensation is beyond the scope of this datasheet. The derivation is based on the feedback equations that have just been covered. The inverse of feedback factor for the circuit in Figure 44 is:

$$\frac{1}{F} = \left(1 + \frac{R_F}{R_{IN}} \right) \left(\frac{1 + s(R_C + R_{IN} \parallel R_F) C}{1 + sR_C C} \right) \quad (4)$$

where 1/F's pole is located at

$$f_p = \frac{1}{2\pi R_C C} \quad (5)$$

1/F's zero is located at

$$f_z = \frac{1}{2\pi(R_C + R_{IN} \parallel R_F)C} \quad (6)$$

$$\left. \frac{1}{F} \right|_{f=0} = 1 + \frac{R_F}{R_{IN}} \quad (7)$$

The circuit gain for [Figure 44](#) at low frequencies is $-R_F/R_{IN}$, but F, the feedback factor is not equal to the circuit gain. The feedback factor is derived from feedback theory and is the same for both inverting and non-inverting configurations. Yes, the feedback factor at low frequencies is equal to the gain for the non-inverting configuration.

$$\left. \frac{1}{F} \right|_{f=\infty} = \left(1 + \frac{R_F}{R_{IN}} \right) \left(1 + \frac{R_{IN} \parallel R_F}{R_C} \right) \quad (8)$$

From this formula, we can see that

- 1/F's zero is located at a lower frequency compared with 1/F's pole.
- 1/F's value at low frequency is $1 + R_F/R_{IN}$.
- This method creates one additional pole and one additional zero.
- This pole-zero pair will serve two purposes:
 - To raise the 1/F value at higher frequencies prior to its intercept with A, the open loop gain curve, in order to meet the $G_{min} = 10$ requirement. For the LMV793/LMV794 some overcompensation will be necessary for good stability.
 - To achieve the previous purpose above with no additional loop phase delay.

Please note the constraint $1/F \geq G_{min}$ needs to be satisfied only in the vicinity where the open loop gain A and 1/F intersect; 1/F can be shaped elsewhere as needed. The 1/F pole must occur before the intersection with the open loop gain A.

In order to have adequate phase margin, it is desirable to follow these two rules:

1. 1/F and the open loop gain A should intersect at the frequency where there is a minimum of 45° of phase margin. When over-compensation is required the intersection point of A and 1/F is set at a frequency where the phase margin is above 45°, therefore increasing the stability of the circuit.
2. 1/F's pole should be set at least one decade below the intersection with the open loop gain A in order to take advantage of the full 90° of phase lead brought by 1/F's pole which is F's zero. This ensures that the effect of the zero is fully neutralized when the 1/F and A plots intersect each other.

Calculating Lead-Lag Compensation for LMV793/LMV794

[Figure 45](#) is the same plot as [Figure 41](#), but the A_{VOL} and phase curves have been redrawn as smooth lines to more readily show the concepts covered, and to clearly show the key parameters used in the calculations for lead-lag compensation.

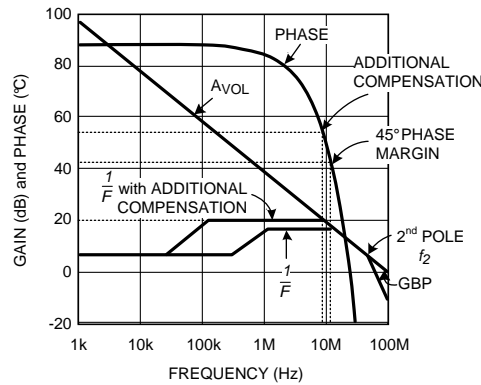

Figure 45. LMV793/LMV794 Simplified Bode Plot

To obtain stable operation with gains under 10 V/V the open loop gain margin must be reduced at high frequencies to where there is a 45° phase margin when the gain margin of the circuit with the external compensation is 0 dB. The pole and zero in F, the feedback factor, control the gain margin at the higher frequencies. The distance between F and A_{VOL} is the gain margin; therefore, the unity gain point (0 dB) is where F crosses the A_{VOL} curve.

For the example being used R_{IN} = R_F for a gain of -1. Therefore F = 6 dB at low frequencies. At the higher frequencies the minimum value for F is 18 dB for 45° phase margin. From Equation 8 we have the following relationship:

$$\left(1 + \frac{R_F}{R_{IN}}\right) \left(1 + \frac{R_{IN} \parallel R_F}{R_C}\right) = 18 \text{ dB} = 7.9 \tag{9}$$

Now set R_F = R_{IN} = R. With these values and solving for R_C we have R_C = R/5.9. Note that the value of C does not affect the ratio between the resistors. Once the value of the resistors are set, then the position of the pole in F must be set. A 2 kΩ resistor is used for R_F and R_{IN} in this design. Therefore the value for R_C is set at 330Ω, the closest standard value for 2 kΩ/5.9.

Rewriting Equation 5 to solve for the minimum capacitor value gives the following equation:

$$C = 1/(2\pi f_p R_C) \tag{10}$$

The feedback factor curve, F, intersects the A_{VOL} curve at about 12 MHz. Therefore the pole of F should not be any larger than 1.2 MHz. Using this value and R_C = 330Ω the minimum value for C is 390 pF. Figure 46 shows that there is too much overshoot, but the part is stable. Increasing C to 2.2 nF did not improve the ringing, as shown in Figure 47.

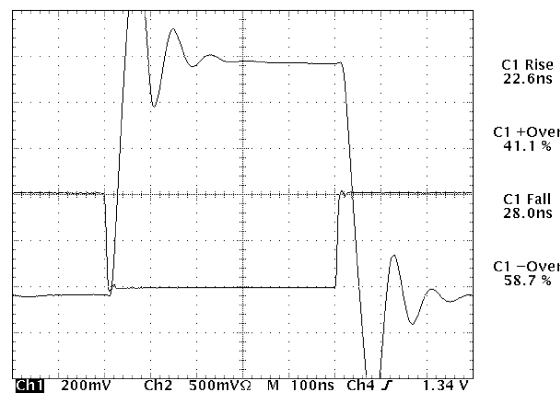

Figure 46. First Try at Compensation, Gain = -1

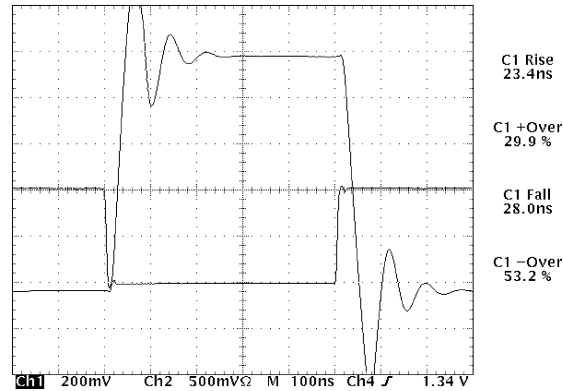

Figure 47. C Increased to 2.2 nF, Gain = -1

Some over-compensation appears to be needed for the desired overshoot characteristics. Instead of intersecting the A_{VOL} curve at 18 dB, 2 dB of over-compensation will be used, and the A_{VOL} curve will be intersected at 20 dB. Using Equation 8 for 20 dB, or 10 V/V, the closest standard value of R_C is 240Ω. The following two waveforms show the new resistor value with $C = 390$ pF and 2.2 nF. Figure 49 shows the final compensation and a very good response for the 1 MHz square wave.

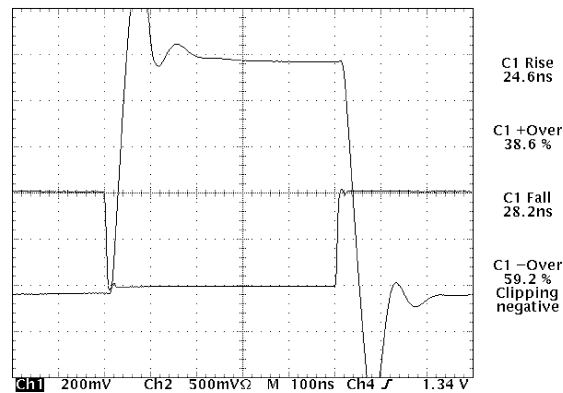

Figure 48. $R_C = 240\Omega$ and $C = 390$ pF, Gain = -1

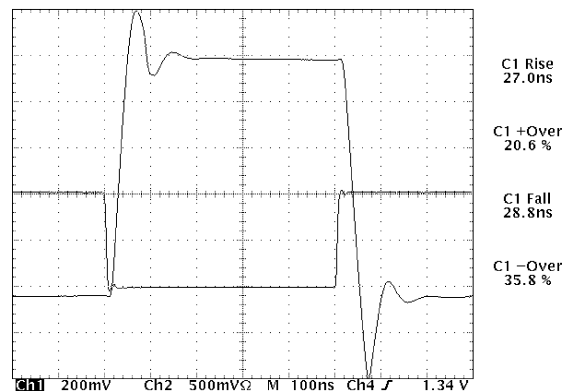

Figure 49. $R_C = 240\Omega$ and $C = 2.2$ nF, Gain = -1

To summarize, the following steps were taken to compensate the LMV793 for a gain of -1 :

1. Values for R_c and C were calculated from the Bode plot to give an expected phase margin of 45° . The values were based on $R_{IN} = R_F = 2\text{ k}\Omega$. These calculations gave $R_c = 330\Omega$ and $C = 390\text{ pF}$.
2. To reduce the ringing C was increased to 2.2 nF which moved the pole of F , the feedback factor, farther away from the A_{VOL} curve.
3. There was still too much ringing so 2 dB of over-compensation was added to F . This was done by decreasing R_c to 240Ω .

The LMV796 is the fully compensated part which is comparable to the LMV793. Using the LMV796 in the same setup, but removing the compensation network, provide the response shown in [Figure 50](#).

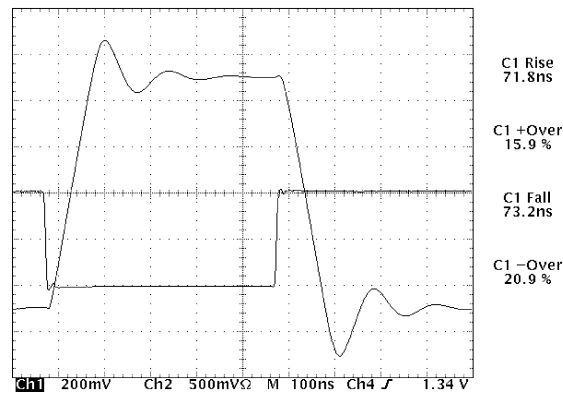

Figure 50. LMV796 Response

For large signal response the rise and fall times are dominated by the slew rate of the op amps. Even though both parts are quite similar the LMV793 will give rise and fall times about 2.5 times faster than the LMV796. This is possible because the LMV793 is a decompensated op amp and even though it is being used at a gain of -1 , the speed is preserved by using a good technique for external compensation.

Non-Inverting Compensation

For the non-inverting amp the same theory applies for establishing the needed compensation. When setting the inverting configuration for a gain of -1 , F has a value of 2. For the non-inverting configuration both F and the actual gain are the same, making the non-inverting configuration more difficult to compensate. Using the same circuit as shown in [Figure 44](#), but setting up the circuit for non-inverting operation (gain of $+2$) results in similar performance as the inverting configuration with the inputs set to half the amplitude to compensate for the additional gain. [Figure 51](#) below shows the results.

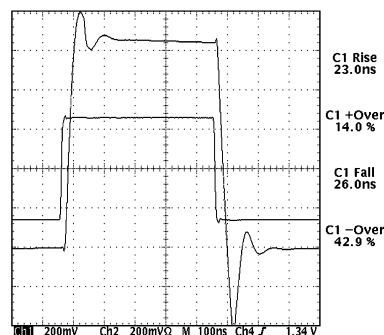

Figure 51. $R_c = 240\Omega$ and $C = 2.2\text{ nF}$, Gain = $+2$

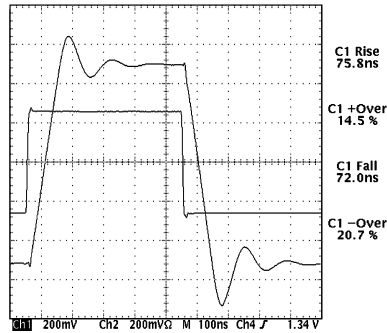

Figure 52. LMV796 Response Gain = +2

The response shown in Figure 51 is close to the response shown in Figure 49. The part is actually slightly faster in the non-inverting configuration. Decreasing the value of R_C to around 200Ω can decrease the negative overshoot but will have slightly longer rise and fall times. The other option is to add a small resistor in series with the input signal. Figure 52 shows the performance of the LMV796 with no compensation. Again the decompensated parts are almost 2.5 times faster than the fully compensated op amp.

The most difficult op amp configuration to stabilize is the gain of +1. With proper compensation the LMV793/LMV794 can be used in this configuration and still maintain higher speeds than the fully compensated parts. Figure 53 shows the gain = 1, or the buffer configuration, for these parts.

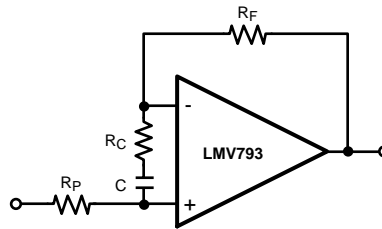

Figure 53. LMV793 with Lead-Lag Compensation for Non-Inverting Configuration

Figure 53 is the result of using Equation 8 and additional experimentation in the lab. R_P is not part of Equation 8, but it is necessary to introduce another pole at the input stage for good performance at gain = +1. Equation 8 is shown below with $R_{IN} = \infty$.

$$\left(1 + \frac{R_F}{R_C} \right) = 18 \text{ dB} = 7.9 \tag{11}$$

Using $2 \text{ k}\Omega$ for R_F and solving for R_C gives $R_C = 2000/6.9 = 290\Omega$. The closest standard value for R_C is 300Ω . After some fine tuning in the lab $R_C = 330\Omega$ and $R_P = 1.5 \text{ k}\Omega$ were chosen as the optimum values. R_P together with the input capacitance at the non-inverting pin inserts another pole into the compensation for the LMV793/LMV794. Adding this pole and slightly reducing the compensation for $1/F$ (using a slightly higher resistor value for R_C) gives the optimum response for a gain of +1. Figure 54 is the response of the circuit shown in Figure 53. Figure 55 shows the response of the LMV796 in the buffer configuration with no compensation and $R_P = R_F = 0$.

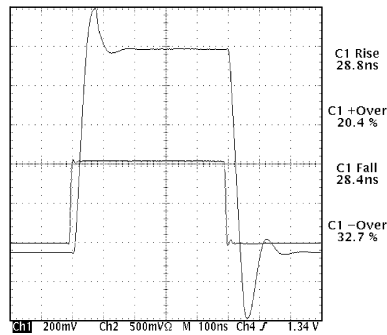

Figure 54. $R_C = 330\Omega$ and $C = 10$ nF, Gain = +1

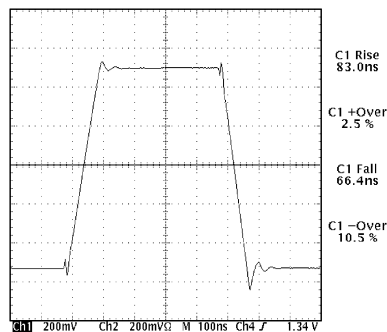

Figure 55. LMV796 Response Gain = +1

With no increase in power consumption the decompensated op amp offers faster speed over the compensated equivalent part. These examples used $R_F = 2$ k Ω . This value is high enough to be easily driven by the LMV793/LMV794, yet small enough to minimize the effects from the parasitic capacitance of both the PCB and the op amp.

Note: When using the LMV793/LMV794, proper high frequency PCB layout must be followed. The GBW of these parts is 88 MHz, making the PCB layout significantly more critical than when using the compensated counterparts which have a GBW of 17 MHz.

TRANSIMPEDANCE AMPLIFIER

An excellent application for either the LMV793 or the LMV794 is as a transimpedance amplifier. With a GBW product of 88 MHz these parts are ideal for high speed data transmission by light. The circuit shown on the front page of the datasheet is the circuit used to test the LMV793/LMV794 as transimpedance amplifiers. The only change is that V_B is tied to the V_{CC} of the part, thus the direction of the diode is reversed from the circuit shown on the front page.

Very high speed components were used in testing to check the limits of the LMV793/LMV794 in a transimpedance configuration. The photo diode part number is PIN-HR040 from OSI Optoelectronics. The diode capacitance for this part is only about 7 pF for the 2.5V bias used (V_{CC} to virtual ground). The rise time for this diode is 1 nsec. A laser diode was used for the light source. Laser diodes have on and off times under 5 nsec. The speed of the selected optical components allowed an accurate evaluation of the LMV793 as a transimpedance amplifier. TI's Evaluation Board for decompensated op amps, PN 551013271-001 A, was used and only minor modifications were necessary and no traces had to be cut.

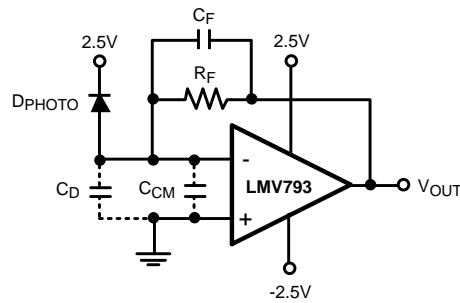

Figure 56. Transimpedance Amplifier

Figure 56 is the complete schematic for a transimpedance amplifier. Only the supply bypass capacitors are not shown. C_D represents the photo diode capacitance which is given on its datasheet. C_{CM} is the input common mode capacitance of the op amp and, for the LMV793 it is shown in the last drawing of the [Typical Performance Characteristics](#) section of this datasheet. In Figure 56 the inverting input pin of the LMV793 is kept at virtual ground. Even though the diode is connected to the 2.5V line, a power supply line is AC ground, thus C_D is connected to ground.

Figure 57 shows the schematic needed to derive F, the feedback factor, for a transimpedance amplifier. In this figure $C_D + C_{CM} = C_{IN}$. Therefore it is critical that the designer knows the diode capacitance and the op amp input capacitance. The photo diode is close to an ideal current source once its capacitance is included in the model. What kind of circuit is this? Without C_F there is only an input capacitor and a feedback resistor. This circuit is a differentiator! Remember, differentiator circuits are inherently unstable and must be compensated. In this case C_F compensates the circuit.

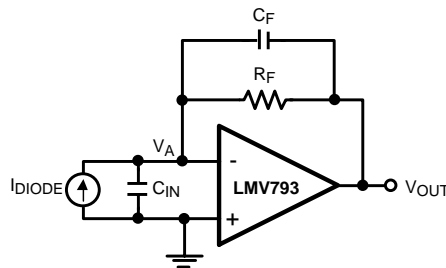

Figure 57. Transimpedance Feedback Model

Using feedback theory, $F = V_A/V_{OUT}$, this becomes a voltage divider giving the following equation:

$$F = \frac{1 + sC_F R_F}{1 + sR_F (C_F + C_{IN})} \quad (12)$$

The noise gain is $1/F$. Because this is a differentiator circuit, a zero must be inserted. The location of the zero is given by:

$$f_z = \frac{1}{1 + sR_F (C_F + C_{IN})} \quad (13)$$

C_F has been added for stability. The addition of this part adds a pole to the circuit. The pole is located at:

$$f_p = \frac{1}{1 + sC_F R_F} \quad (14)$$

To attain maximum bandwidth and still have good stability the pole is to be located on the open loop gain curve which is A. If additional compensation is required one can always increase the value of C_F , but this will also reduce the bandwidth of the circuit. Therefore $A = 1/F$, or $AF = 1$. For A the equation is:

$$A = \frac{\omega_{GBW}}{\omega} = \frac{f_{GBW}}{f} \tag{15}$$

The expression f_{GBW} is the gain bandwidth product of the part. For a unity gain stable part this is the frequency where $A = 1$. For the LMV793 $f_{GBW} = 88$ MHz. Multiplying A and F results in the following equation:

$$AF \Big|_{f_p} = \frac{f_{GBW}}{f} \times \frac{1 + sC_F R_F}{1 + sR_F (C_F + C_{IN})} = 1$$

$$\frac{f_{GBW}}{f} \times \frac{\sqrt{1 + \left(\frac{C_F R_F}{C_F R_F}\right)^2}}{\sqrt{1 + \left(\frac{R_F (C_F + C_{IN})}{C_F R_F}\right)^2}} = 1 \tag{16}$$

For the above equation $s = j\omega$. To find the actual amplitude of the equation the square root of the square of the real and imaginary parts are calculated. At the intersection of F and A , we have:

$$\omega = \frac{1}{C_F R_F} \tag{17}$$

After a bit of algebraic manipulation the above equation reduces to:

$$1 + \left(\frac{C_F + C_{IN}}{C_F}\right)^2 = 8\pi^2 f_{GBW}^2 R_F^2 C_F^2 \tag{18}$$

In the above equation the only unknown is C_F . In trying to solve this equation the fourth power of C_F must be dealt with. An excel spread sheet with this equation can be used and all the known values entered. Then through iteration, the value of C_F when both sides are equal will be found. That is the correct value for C_F , and of course the closest standard value is used for C_F .

Before moving the lab, the transfer function of the transimpedance amplifier must be found and the units must be in Ohms.

$$V_{OUT} = \frac{-R_F}{1 + sC_F R_F} \times I_{DIODE} \tag{19}$$

The LMV793 was evaluated for $R_F = 10$ k Ω and 100 k Ω , representing a somewhat lower gain configuration and with the 100 k Ω feedback resistor a fairly high gain configuration. The $R_F = 10$ k Ω is covered first. Looking at the [Figure 39](#) chart for C_{CM} for the operating point selected $C_{CM} = 15$ pF. Note that for split supplies $V_{CM} = 2.5$ V, $C_{IN} = 22$ pF and $f_{GBW} = 88$ MHz. Solving for C_F the calculated value is 1.75 pF, so 1.8 pF is selected for use. Checking the frequency of the pole finds that it is at 8.8 MHz, which is right at the minimum gain recommended for this part. Some over compensation was necessary for stability and the final selected value for C_F is 2.7 pF. This moves the pole to 5.9 MHz. [Figure 58](#) and [Figure 59](#) show the rise and fall times obtained in the lab with a 1V output swing. The laser diode was difficult to drive due to thermal effects making the starting and ending point of the pulse quite different, therefore the two separate scope pictures.

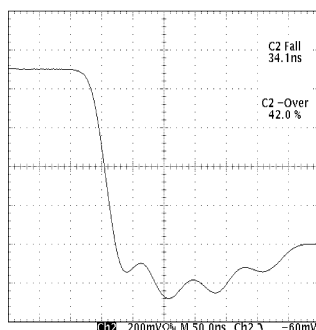

Figure 58. Fall Time

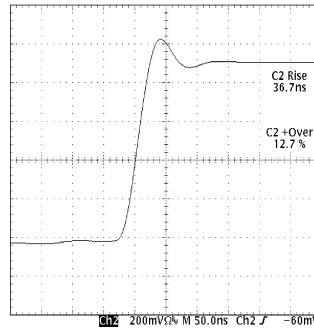

Figure 59. Rise Time

In Figure 58 the ringing and the hump during the on time is from the laser. The higher drive levels for the laser gave ringing in the light source as well as light changing from the thermal characteristics. The hump is due to the thermal characteristics.

Solving for C_F using a 100 k Ω feedback resistor, the calculated value is 0.54 pF. One of the problems with more gain is the very small value for C_F . A 0.5 pF capacitor was used, its measured value being 0.64 pF. For the 0.64 pF location the pole is at 2.5 MHz. Figure 60 shows the response for a 1V output.

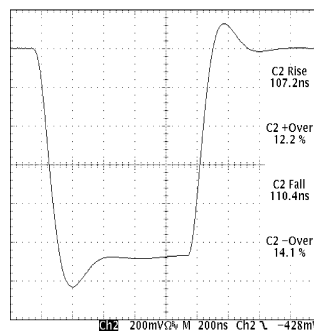

Figure 60. High Gain Response

A transimpedance amplifier is an excellent application for the LMV793. Even with the high gain using a 100 k Ω feedback resistor, the bandwidth is still well over 1 MHz. Other than a little over compensation for the 10 k Ω feedback resistor configuration using the LMV793 was quite easy. Of course a very good board layout was also used for this test. For information on photo diodes please contact OSI Optoelectronics, (310) 978-0516. For further information on transimpedance amplifiers please contact your Texas Instruments representative.

REVISION HISTORY

| Changes from Revision C (March 2013) to Revision D | Page |
|--|--------------------|
| • Changed layout of National Data Sheet to TI format | 23 |

PACKAGING INFORMATION

| Orderable Device | Status (1) | Package Type | Package Drawing | Pins | Package Qty | Eco Plan (2) | Lead/Ball Finish | MSL Peak Temp (3) | Op Temp (°C) | Top-Side Markings (4) | Samples |
|------------------|---------------|--------------|-----------------|------|-------------|-------------------------|------------------|----------------------|--------------|--------------------------|-------------------------|
| LMV793MA/NOPB | ACTIVE | SOIC | D | 8 | 95 | Green (RoHS & no Sb/Br) | CU SN | Level-1-260C-UNLIM | -40 to 125 | LMV793MA | Samples |
| LMV793MAX/NOPB | ACTIVE | SOIC | D | 8 | 2500 | Green (RoHS & no Sb/Br) | CU SN | Level-1-260C-UNLIM | -40 to 125 | LMV793MA | Samples |
| LMV793MF/NOPB | ACTIVE | SOT-23 | DBV | 5 | 1000 | Green (RoHS & no Sb/Br) | CU SN | Level-1-260C-UNLIM | -40 to 125 | AS4A | Samples |
| LMV793MFX/NOPB | ACTIVE | SOT-23 | DBV | 5 | 3000 | Green (RoHS & no Sb/Br) | CU SN | Level-1-260C-UNLIM | -40 to 125 | AS4A | Samples |
| LMV794MA/NOPB | ACTIVE | SOIC | D | 8 | 95 | Green (RoHS & no Sb/Br) | CU SN | Level-1-260C-UNLIM | -40 to 125 | LMV794MA | Samples |
| LMV794MAX/NOPB | ACTIVE | SOIC | D | 8 | 2500 | Green (RoHS & no Sb/Br) | CU SN | Level-1-260C-UNLIM | -40 to 125 | LMV794MA | Samples |
| LMV794MM/NOPB | ACTIVE | VSSOP | DGK | 8 | 1000 | Green (RoHS & no Sb/Br) | CU SN | Level-1-260C-UNLIM | -40 to 125 | AN4A | Samples |
| LMV794MMX/NOPB | ACTIVE | VSSOP | DGK | 8 | 3500 | Green (RoHS & no Sb/Br) | CU SN | Level-1-260C-UNLIM | -40 to 125 | AN4A | Samples |

(1) The marketing status values are defined as follows:

ACTIVE: Product device recommended for new designs.

LIFEBUY: TI has announced that the device will be discontinued, and a lifetime-buy period is in effect.

NRND: Not recommended for new designs. Device is in production to support existing customers, but TI does not recommend using this part in a new design.

PREVIEW: Device has been announced but is not in production. Samples may or may not be available.

OBSOLETE: TI has discontinued the production of the device.

(2) Eco Plan - The planned eco-friendly classification: Pb-Free (RoHS), Pb-Free (RoHS Exempt), or Green (RoHS & no Sb/Br) - please check <http://www.ti.com/productcontent> for the latest availability information and additional product content details.

TBD: The Pb-Free/Green conversion plan has not been defined.

Pb-Free (RoHS): TI's terms "Lead-Free" or "Pb-Free" mean semiconductor products that are compatible with the current RoHS requirements for all 6 substances, including the requirement that lead not exceed 0.1% by weight in homogeneous materials. Where designed to be soldered at high temperatures, TI Pb-Free products are suitable for use in specified lead-free processes.

Pb-Free (RoHS Exempt): This component has a RoHS exemption for either 1) lead-based flip-chip solder bumps used between the die and package, or 2) lead-based die adhesive used between the die and leadframe. The component is otherwise considered Pb-Free (RoHS compatible) as defined above.

Green (RoHS & no Sb/Br): TI defines "Green" to mean Pb-Free (RoHS compatible), and free of Bromine (Br) and Antimony (Sb) based flame retardants (Br or Sb do not exceed 0.1% by weight in homogeneous material)

(3) MSL, Peak Temp. -- The Moisture Sensitivity Level rating according to the JEDEC industry standard classifications, and peak solder temperature.

⁽⁴⁾ Multiple Top-Side Markings will be inside parentheses. Only one Top-Side Marking contained in parentheses and separated by a "~" will appear on a device. If a line is indented then it is a continuation of the previous line and the two combined represent the entire Top-Side Marking for that device.

Important Information and Disclaimer:The information provided on this page represents TI's knowledge and belief as of the date that it is provided. TI bases its knowledge and belief on information provided by third parties, and makes no representation or warranty as to the accuracy of such information. Efforts are underway to better integrate information from third parties. TI has taken and continues to take reasonable steps to provide representative and accurate information but may not have conducted destructive testing or chemical analysis on incoming materials and chemicals. TI and TI suppliers consider certain information to be proprietary, and thus CAS numbers and other limited information may not be available for release.

In no event shall TI's liability arising out of such information exceed the total purchase price of the TI part(s) at issue in this document sold by TI to Customer on an annual basis.

TAPE AND REEL INFORMATION

QUADRANT ASSIGNMENTS FOR PIN 1 ORIENTATION IN TAPE

*All dimensions are nominal

| Device | Package Type | Package Drawing | Pins | SPQ | Reel Diameter (mm) | Reel Width W1 (mm) | A0 (mm) | B0 (mm) | K0 (mm) | P1 (mm) | W (mm) | Pin1 Quadrant |
|----------------|--------------|-----------------|------|------|--------------------|--------------------|---------|---------|---------|---------|--------|---------------|
| LMV793MAX/NOPB | SOIC | D | 8 | 2500 | 330.0 | 12.4 | 6.5 | 5.4 | 2.0 | 8.0 | 12.0 | Q1 |
| LMV793MF/NOPB | SOT-23 | DBV | 5 | 1000 | 178.0 | 8.4 | 3.2 | 3.2 | 1.4 | 4.0 | 8.0 | Q3 |
| LMV793MFX/NOPB | SOT-23 | DBV | 5 | 3000 | 178.0 | 8.4 | 3.2 | 3.2 | 1.4 | 4.0 | 8.0 | Q3 |
| LMV794MAX/NOPB | SOIC | D | 8 | 2500 | 330.0 | 12.4 | 6.5 | 5.4 | 2.0 | 8.0 | 12.0 | Q1 |
| LMV794MM/NOPB | VSSOP | DGK | 8 | 1000 | 178.0 | 12.4 | 5.3 | 3.4 | 1.4 | 8.0 | 12.0 | Q1 |
| LMV794MMX/NOPB | VSSOP | DGK | 8 | 3500 | 330.0 | 12.4 | 5.3 | 3.4 | 1.4 | 8.0 | 12.0 | Q1 |

TAPE AND REEL BOX DIMENSIONS



*All dimensions are nominal

| Device | Package Type | Package Drawing | Pins | SPQ | Length (mm) | Width (mm) | Height (mm) |
|----------------|--------------|-----------------|------|------|-------------|------------|-------------|
| LMV793MAX/NOPB | SOIC | D | 8 | 2500 | 367.0 | 367.0 | 35.0 |
| LMV793MF/NOPB | SOT-23 | DBV | 5 | 1000 | 210.0 | 185.0 | 35.0 |
| LMV793MFX/NOPB | SOT-23 | DBV | 5 | 3000 | 210.0 | 185.0 | 35.0 |
| LMV794MAX/NOPB | SOIC | D | 8 | 2500 | 367.0 | 367.0 | 35.0 |
| LMV794MM/NOPB | VSSOP | DGK | 8 | 1000 | 210.0 | 185.0 | 35.0 |
| LMV794MMX/NOPB | VSSOP | DGK | 8 | 3500 | 367.0 | 367.0 | 35.0 |

MECHANICAL DATA

DBV (R-PDSO-G5)

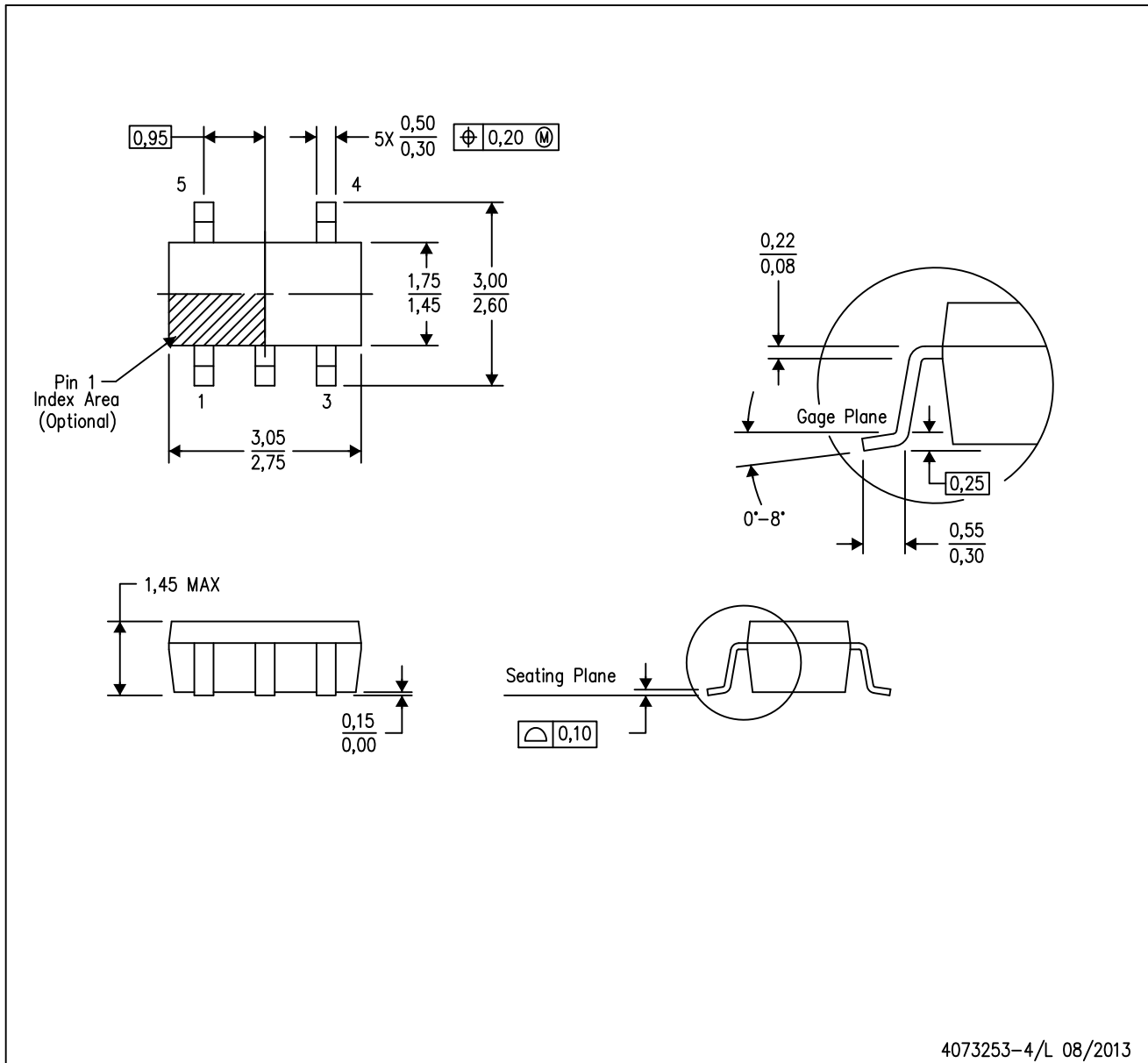
PLASTIC SMALL-OUTLINE PACKAGE



- NOTES:
- All linear dimensions are in millimeters.
 - This drawing is subject to change without notice.
 - Body dimensions do not include mold flash or protrusion. Mold flash and protrusion shall not exceed 0.15 per side.
 - Falls within JEDEC MO-178 Variation AA.

DBV (R-PDSO-G5)

PLASTIC SMALL OUTLINE



- NOTES:
- A. All linear dimensions are in millimeters.
 - B. This drawing is subject to change without notice.
 - C. Customers should place a note on the circuit board fabrication drawing not to alter the center solder mask defined pad.
 - D. Publication IPC-7351 is recommended for alternate designs.
 - E. Laser cutting apertures with trapezoidal walls and also rounding corners will offer better paste release. Customers should contact their board assembly site for stencil design recommendations. Example stencil design based on a 50% volumetric metal load solder paste. Refer to IPC-7525 for other stencil recommendations.

DGK (S-PDSO-G8)

PLASTIC SMALL-OUTLINE PACKAGE



- NOTES:
- A. All linear dimensions are in millimeters.
 - B. This drawing is subject to change without notice.
 - C. Body length does not include mold flash, protrusions, or gate burrs. Mold flash, protrusions, or gate burrs shall not exceed 0.15 per end.
 - D. Body width does not include interlead flash. Interlead flash shall not exceed 0.50 per side.
 - E. Falls within JEDEC MO-187 variation AA, except interlead flash.

D (R-PDSO-G8)

PLASTIC SMALL OUTLINE



NOTES: A. All linear dimensions are in inches (millimeters).
 B. This drawing is subject to change without notice.
 C. Body length does not include mold flash, protrusions, or gate burrs. Mold flash, protrusions, or gate burrs shall not exceed 0.006 (0,15) each side.
 D. Body width does not include interlead flash. Interlead flash shall not exceed 0.017 (0,43) each side.
 E. Reference JEDEC MS-012 variation AA.

IMPORTANT NOTICE

Texas Instruments Incorporated and its subsidiaries (TI) reserve the right to make corrections, enhancements, improvements and other changes to its semiconductor products and services per JESD46, latest issue, and to discontinue any product or service per JESD48, latest issue. Buyers should obtain the latest relevant information before placing orders and should verify that such information is current and complete. All semiconductor products (also referred to herein as "components") are sold subject to TI's terms and conditions of sale supplied at the time of order acknowledgment.

TI warrants performance of its components to the specifications applicable at the time of sale, in accordance with the warranty in TI's terms and conditions of sale of semiconductor products. Testing and other quality control techniques are used to the extent TI deems necessary to support this warranty. Except where mandated by applicable law, testing of all parameters of each component is not necessarily performed.

TI assumes no liability for applications assistance or the design of Buyers' products. Buyers are responsible for their products and applications using TI components. To minimize the risks associated with Buyers' products and applications, Buyers should provide adequate design and operating safeguards.

TI does not warrant or represent that any license, either express or implied, is granted under any patent right, copyright, mask work right, or other intellectual property right relating to any combination, machine, or process in which TI components or services are used. Information published by TI regarding third-party products or services does not constitute a license to use such products or services or a warranty or endorsement thereof. Use of such information may require a license from a third party under the patents or other intellectual property of the third party, or a license from TI under the patents or other intellectual property of TI.

Reproduction of significant portions of TI information in TI data books or data sheets is permissible only if reproduction is without alteration and is accompanied by all associated warranties, conditions, limitations, and notices. TI is not responsible or liable for such altered documentation. Information of third parties may be subject to additional restrictions.

Resale of TI components or services with statements different from or beyond the parameters stated by TI for that component or service voids all express and any implied warranties for the associated TI component or service and is an unfair and deceptive business practice. TI is not responsible or liable for any such statements.

Buyer acknowledges and agrees that it is solely responsible for compliance with all legal, regulatory and safety-related requirements concerning its products, and any use of TI components in its applications, notwithstanding any applications-related information or support that may be provided by TI. Buyer represents and agrees that it has all the necessary expertise to create and implement safeguards which anticipate dangerous consequences of failures, monitor failures and their consequences, lessen the likelihood of failures that might cause harm and take appropriate remedial actions. Buyer will fully indemnify TI and its representatives against any damages arising out of the use of any TI components in safety-critical applications.

In some cases, TI components may be promoted specifically to facilitate safety-related applications. With such components, TI's goal is to help enable customers to design and create their own end-product solutions that meet applicable functional safety standards and requirements. Nonetheless, such components are subject to these terms.

No TI components are authorized for use in FDA Class III (or similar life-critical medical equipment) unless authorized officers of the parties have executed a special agreement specifically governing such use.

Only those TI components which TI has specifically designated as military grade or "enhanced plastic" are designed and intended for use in military/aerospace applications or environments. Buyer acknowledges and agrees that any military or aerospace use of TI components which have **not** been so designated is solely at the Buyer's risk, and that Buyer is solely responsible for compliance with all legal and regulatory requirements in connection with such use.

TI has specifically designated certain components as meeting ISO/TS16949 requirements, mainly for automotive use. In any case of use of non-designated products, TI will not be responsible for any failure to meet ISO/TS16949.

Products

| | |
|------------------------------|--|
| Audio | www.ti.com/audio |
| Amplifiers | amplifier.ti.com |
| Data Converters | dataconverter.ti.com |
| DLP® Products | www.dlp.com |
| DSP | dsp.ti.com |
| Clocks and Timers | www.ti.com/clocks |
| Interface | interface.ti.com |
| Logic | logic.ti.com |
| Power Mgmt | power.ti.com |
| Microcontrollers | microcontroller.ti.com |
| RFID | www.ti-rfid.com |
| OMAP Applications Processors | www.ti.com/omap |
| Wireless Connectivity | www.ti.com/wirelessconnectivity |

Applications

| | |
|-------------------------------|--|
| Automotive and Transportation | www.ti.com/automotive |
| Communications and Telecom | www.ti.com/communications |
| Computers and Peripherals | www.ti.com/computers |
| Consumer Electronics | www.ti.com/consumer-apps |
| Energy and Lighting | www.ti.com/energy |
| Industrial | www.ti.com/industrial |
| Medical | www.ti.com/medical |
| Security | www.ti.com/security |
| Space, Avionics and Defense | www.ti.com/space-avionics-defense |
| Video and Imaging | www.ti.com/video |

TI E2E Community

e2e.ti.com