



# STGW30NC120HD

N-channel 1200V - 30A - TO-247  
very fast PowerMESH™ IGBT

## Features

Type	V <sub>CES</sub>	V <sub>CE(sat)</sub> @25°C	I <sub>C</sub> @100°C
STGW30NC120HD	1200V	< 2.75V	30A

- Low on-losses
- Low on-voltage drop (V<sub>cesat</sub>)
- High current capability
- High input impedance (voltage driven)
- Low gate charge
- Ideal for soft switching application

## Application

- Induction heating

## Description

Using the latest high voltage technology based on its patented strip layout, STMicroelectronics has designed an advanced family of IGBTs, with outstanding performances. The suffix “H” identifies a family optimized for high frequency application in order to achieve very high switching performances (reduced t<sub>fall</sub>) maintaining a low voltage drop.

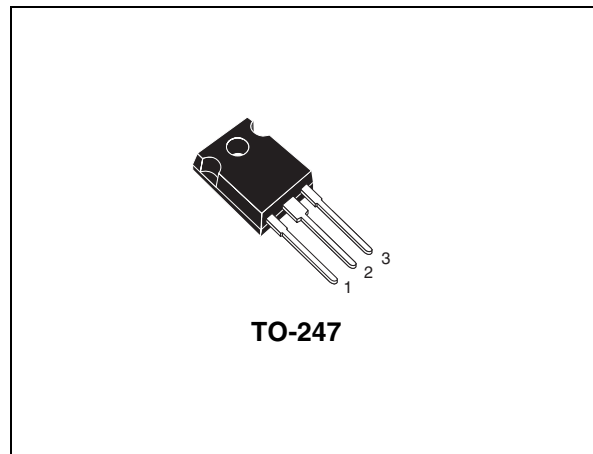

Figure 1. Internal schematic diagram

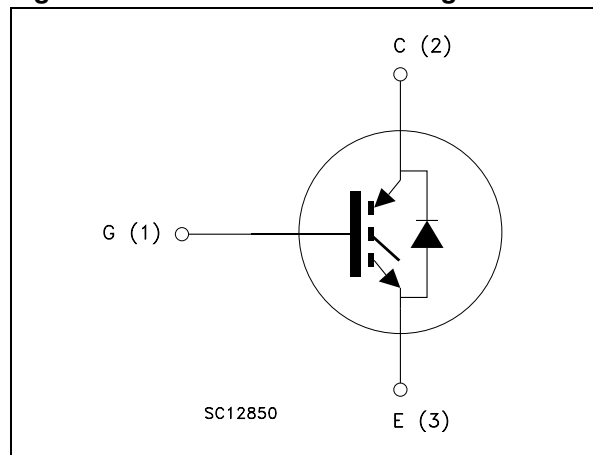

Table 1. Device summary

Order code	Marking	Package	Packaging
STGW30NC120HD	GW30NC120HD	TO-247	Tube

## Contents

<b>1</b>	<b>Electrical ratings</b> .....	<b>3</b>
<b>2</b>	<b>Electrical characteristics</b> .....	<b>4</b>
	2.1 Electrical characteristics (curves) .....	6
<b>3</b>	<b>Test circuit</b> .....	<b>9</b>
<b>4</b>	<b>Package mechanical data</b> .....	<b>10</b>
<b>5</b>	<b>Revision history</b> .....	<b>12</b>

# 1 Electrical ratings

**Table 2. Absolute maximum ratings**

Symbol	Parameter	Value	Unit
$V_{CES}$	Collector-emitter voltage ( $V_{GS} = 0$ )	1200	V
$I_C^{(1)}$	Collector current (continuous) at 25°C	60	A
$I_C^{(1)}$	Collector current (continuous) at 100°C	30	A
$I_{CL}^{(2)}$	Collector current (pulsed)	135	A
$V_{GE}$	Gate-emitter voltage	±25	V
$P_{TOT}$	Total dissipation at $T_C = 25^\circ\text{C}$	220	W
$I_f$	Diode RMS forward current at $T_C = 25^\circ\text{C}$	30	A
$T_j$	Operating junction temperature	-55 to 150	°C

1. Calculated according to the iterative formula:

$$I_C(T_C) = \frac{T_{JMAX} - T_C}{R_{THJ-C} \times V_{CESAT(MAX)}(T_C, I_C)}$$

2.  $V_{clamp}=80\%$  of  $BV_{ces}$ ,  $T_j=150^\circ\text{C}$ ,  $R_G=10\Omega$ ,  $V_{GE}=15\text{V}$

**Table 3. Thermal resistance**

Symbol	Parameter	Value	Unit
$R_{thj-case}$	Thermal resistance junction-case	0.57	°C/W
$R_{thj-amb}$	Thermal resistance junction-ambient (diode)	1.6	°C/W
$R_{thj-amb}$	Thermal resistance junction-ambient (IGBT)	30	°C/W

## 2 Electrical characteristics

( $T_{CASE}=25^{\circ}C$  unless otherwise specified)

**Table 4. Static**

Symbol	Parameter	Test conditions	Min.	Typ.	Max.	Unit
$V_{BR(CES)}$	Collector-emitter breakdown voltage	$I_C = 1mA, V_{GE} = 0$	1200			V
$V_{CE(SAT)}$	Collector-emitter saturation voltage	$V_{GE}= 15V, I_C= 20A, T_j= 25^{\circ}C$ $V_{GE}= 15V, I_C= 20A, T_j=125^{\circ}C$		2.2 2.0	2.75	V V
$V_{GE(th)}$	Gate threshold voltage	$V_{CE}= V_{GE}, I_C= 250\mu A$	3.75		5.75	V
$I_{CES}$	Collector-emitter leakage current ( $V_{GE} = 0$ )	$V_{CE} = \text{Max rating}, T_c=25^{\circ}C$ $V_{CE} = \text{Max rating}, T_c=125^{\circ}C$			500 10	$\mu A$ mA
$I_{GES}$	Gate-emitter leakage current ( $V_{CE} = 0$ )	$V_{GE} = \pm 20V, V_{CE} = 0$			$\pm 100$	nA
$g_{fs}$	Forward transconductance	$V_{CE} = 25V, I_C= 20A$		14		S

**Table 5. Dynamic**

Symbol	Parameter	Test conditions	Min.	Typ.	Max.	Unit
$C_{ies}$	Input capacitance	$V_{CE} = 25V, f = 1 \text{ MHz}, V_{GE}=0$		2510		pF
$C_{oes}$	Output capacitance			175		pF
$C_{res}$	Reverse transfer capacitance			30		pF
$Q_g$	Total gate charge	$V_{CE} = 960V,$ $I_C= 20A, V_{GE}=15V$		110		nC
$Q_{ge}$	Gate-emitter charge			16		nC
$Q_{gc}$	Gate-collector charge			49		nC

**Table 6. Switching on/off (inductive load)**

Symbol	Parameter	Test conditions	Min.	Typ.	Max.	Unit
$t_{d(on)}$	Turn-on delay time	$V_{CC} = 960V, I_C = 20A$		29		ns
$t_r$	Current rise time	$R_G = 10\Omega, V_{GE} = 15V,$		11		ns
$(di/dt)_{on}$	Turn-on current slope	$T_j = 25^\circ C$ (see Figure 17)		1820		A/ $\mu s$
$t_{d(on)}$	Turn-on delay time	$V_{CC} = 960V, I_C = 20A$		27		ns
$t_r$	Current rise time	$R_G = 10\Omega, V_{GE} = 15V,$		14		ns
$(di/dt)_{on}$	Turn-on current slope	$T_j = 125^\circ C$ (see Figure 17)		1580		A/ $\mu s$
$t_r(V_{off})$	Off voltage rise time	$V_{CC} = 960V, I_C = 20A$		90		ns
$t_{d(off)}$	Turn-off delay time	$R_G = 10\Omega, V_{GE} = 15V,$		275		ns
$t_f$	Current fall time	$T_j = 25^\circ C$ (see Figure 17)		312		ns
$t_r(V_{off})$	Off voltage rise time	$V_{CC} = 960V, I_C = 20A$		150		ns
$t_{d(off)}$	Turn-off delay time	$R_G = 10\Omega, V_{GE} = 15V,$		336		ns
$t_f$	Current fall time	$T_j = 125^\circ C$ (see Figure 17)		592		ns

**Table 7. Switching energy (inductive load)**

Symbol	Parameter	Test conditions	Min.	Typ.	Max.	Unit
$E_{on}^{(1)}$	Turn-on switching losses	$V_{CC} = 960V, I_C = 20A$		1660		$\mu J$
$E_{off}^{(2)}$	Turn-off switching losses	$R_G = 10\Omega, V_{GE} = 15V,$		4438		$\mu J$
$E_{ts}$	Total switching losses	$T_j = 25^\circ C$ (see Figure 17)		6098		$\mu J$
$E_{on}^{(1)}$	Turn-on switching losses	$V_{CC} = 960V, I_C = 20A$		3015		$\mu J$
$E_{off}^{(2)}$	Turn-off switching losses	$R_G = 10\Omega, V_{GE} = 15V,$		6900		$\mu J$
$E_{ts}$	Total switching losses	$T_j = 125^\circ C$ (see Figure 17)		9915		$\mu J$

1.  $E_{on}$  is the turn-on losses when a typical diode is used in the test circuit in figure 2. If the IGBT is offered in a package with a co-pack diode, the co-pack diode is used as external diode. IGBTs & Diode are at the same temperature (25°C and 125°C)

2. Turn-off losses include also the tail of the collector current

**Table 8. Collector-emitter diode**

Symbol	Parameter	Test conditions	Min.	Typ.	Max.	Unit
$V_f$	Forward on-voltage	$I_f = 20A, T_j = 25^\circ C$ $I_f = 20A, T_j = 125^\circ C$		1.9 1.7	2.5	V V
$t_{rr}$	Reverse recovery time	$I_f = 20A, V_R = 27V,$		152		ns
$Q_{rr}$	Reverse recovery charge	$T_j = 125^\circ C, di/dt = 100A/\mu s$		722		nC
$I_{rrm}$	Reverse recovery current	(see Figure 20)		9		A

## 2.1 Electrical characteristics (curves)

Figure 2. Output characteristics

Figure 3. Transfer characteristics

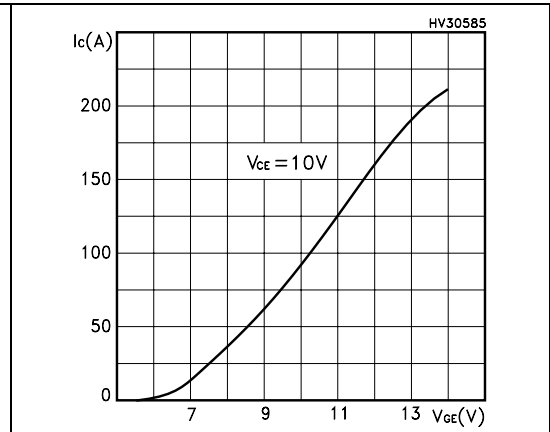
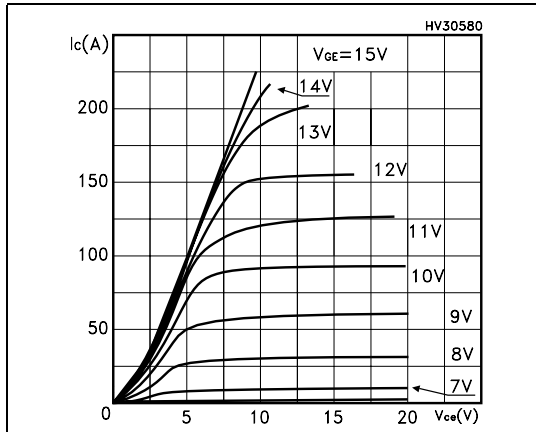

Figure 4. Transconductance

Figure 5. Collector-emitter on voltage vs. temperature

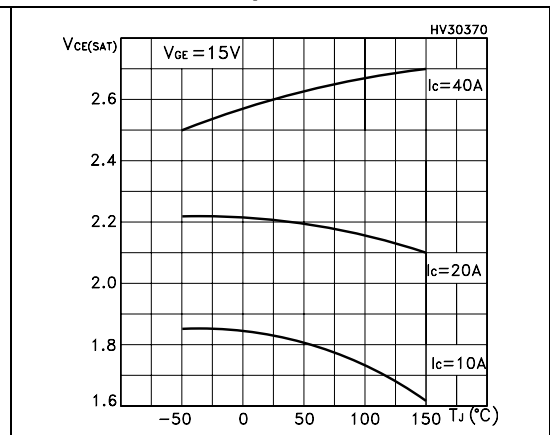
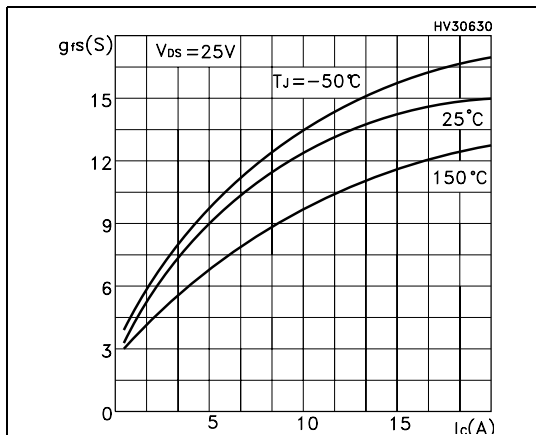
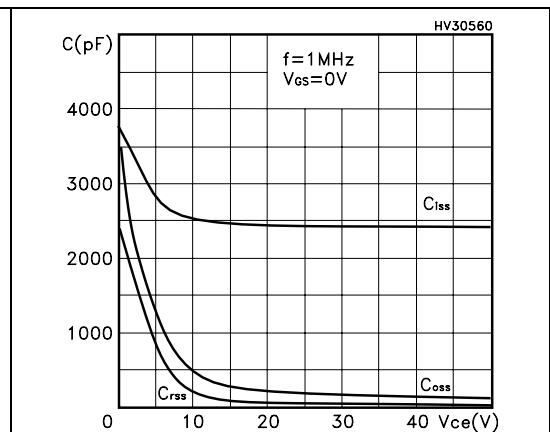
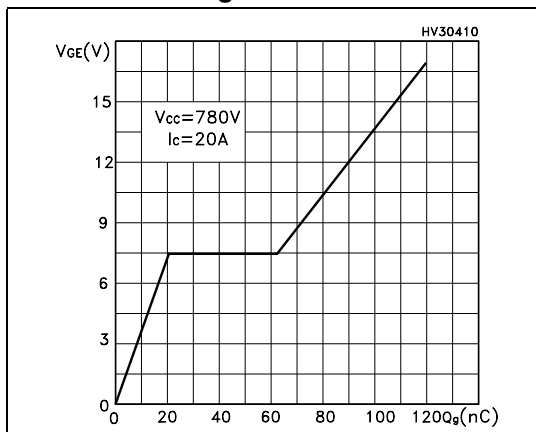
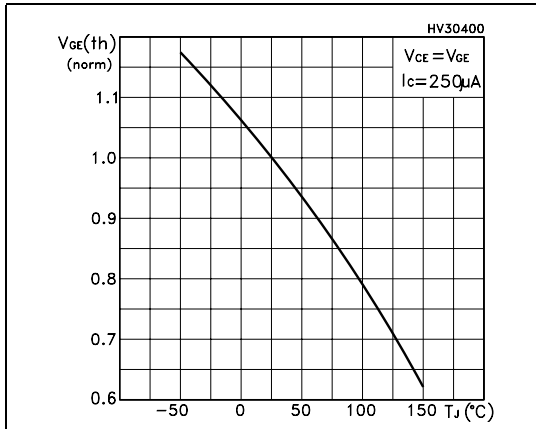

Figure 6. Gate charge vs. gate-source voltage

Figure 7. Capacitance variations



**Figure 8. Normalized gate threshold voltage vs. temperature**



**Figure 9. Collector-emitter on voltage vs. collector current**

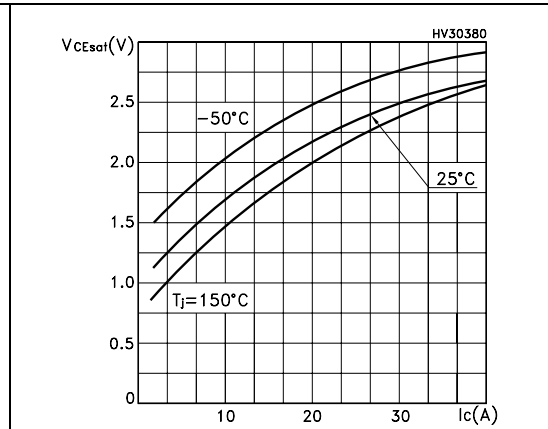

**Figure 10. Normalized breakdown voltage vs. temperature**

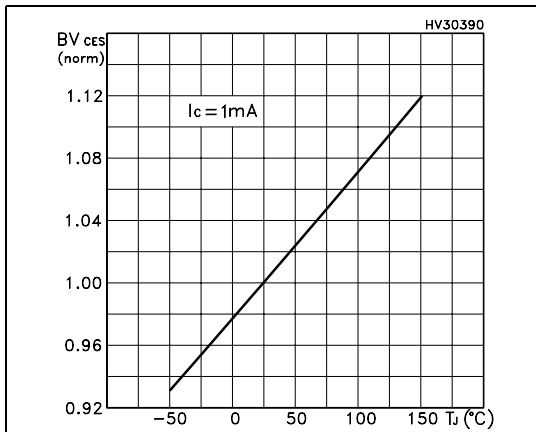

**Figure 11. Switching losses vs. temperature**

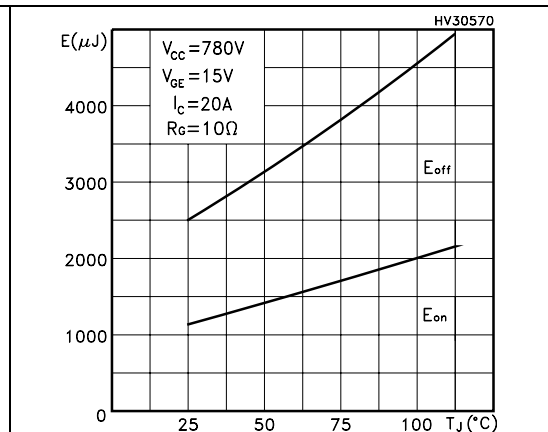

**Figure 12. Switching losses vs. gate resistance**

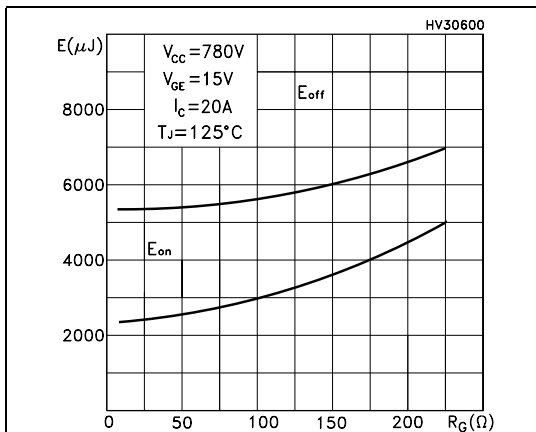

**Figure 13. Switching losses vs. collector current**

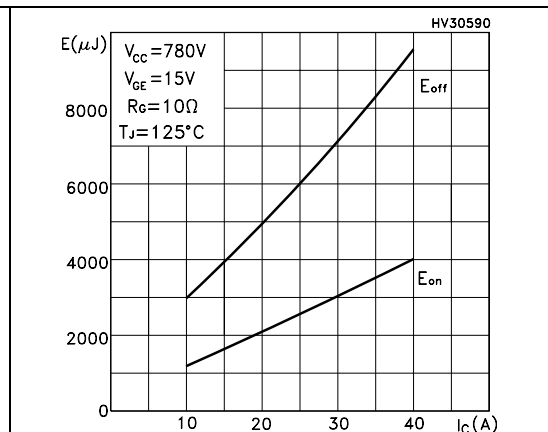

Figure 14. Thermal Impedance

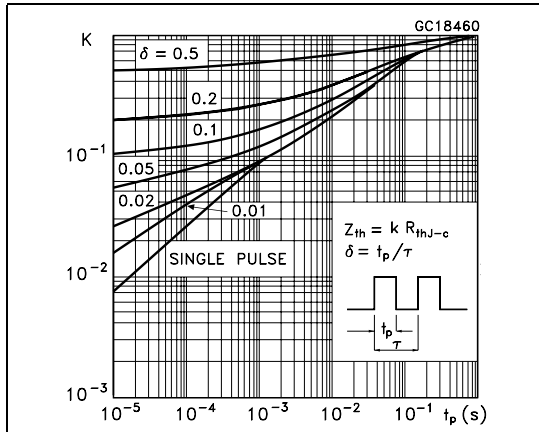

Figure 15. Turn-off SOA

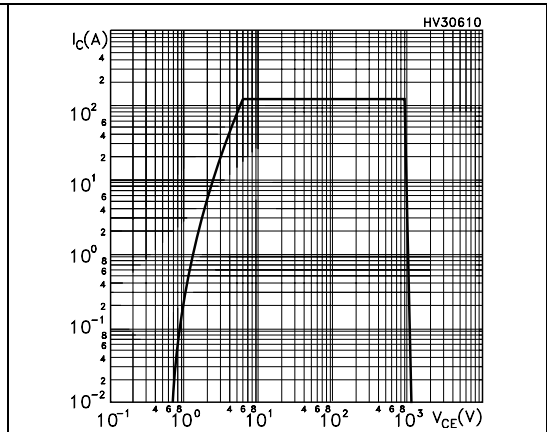
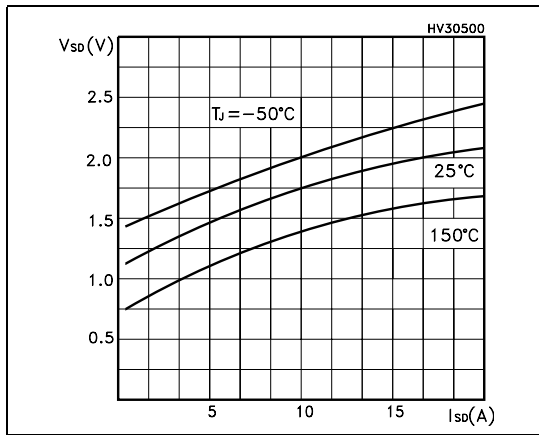

Figure 16. Emitter-collector diode characteristics





### 3 Test circuit

Figure 17. Test circuit for inductive load switching

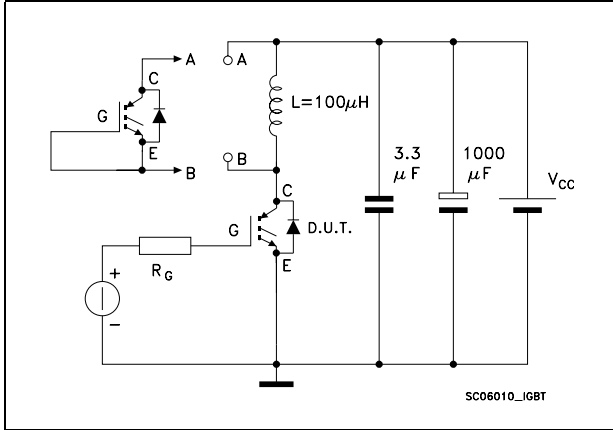

Figure 18. Gate charge test circuit

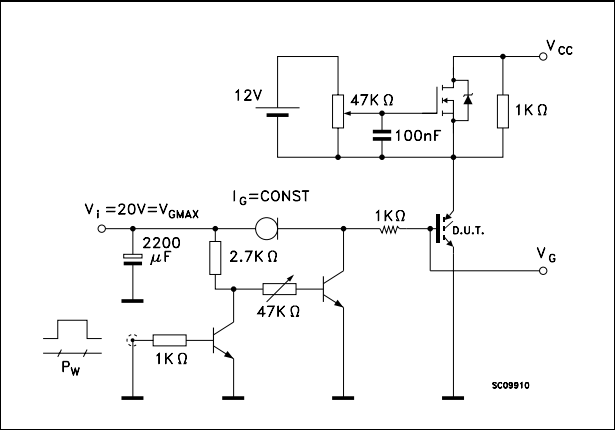

Figure 19. Switching waveform

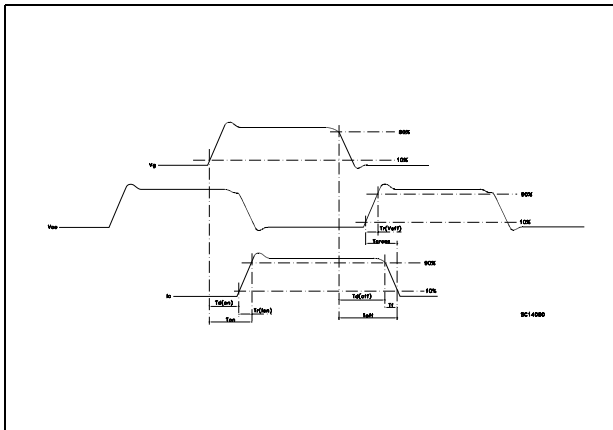
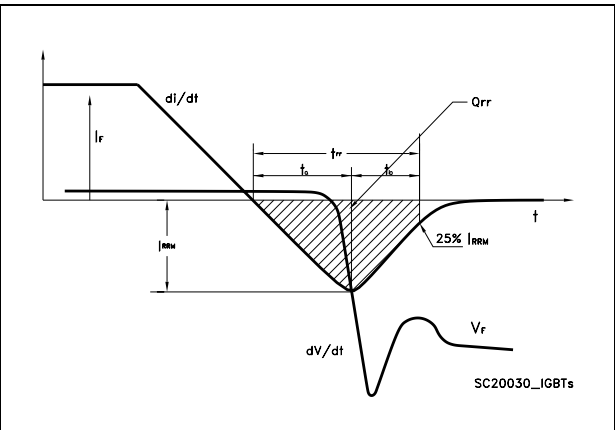

Figure 20. Diode recovery time waveform



## 4 Package mechanical data

In order to meet environmental requirements, ST offers these devices in ECOPACK® packages. These packages have a Lead-free second level interconnect. The category of second level interconnect is marked on the package and on the inner box label, in compliance with JEDEC Standard JESD97. The maximum ratings related to soldering conditions are also marked on the inner box label. ECOPACK is an ST trademark. ECOPACK specifications are available at: [www.st.com](http://www.st.com)

## TO-247 MECHANICAL DATA

DIM.	mm.			inch		
	MIN.	TYP	MAX.	MIN.	TYP.	MAX.
A	4.85		5.15	0.19		0.20
A1	2.20		2.60	0.086		0.102
b	1.0		1.40	0.039		0.055
b1	2.0		2.40	0.079		0.094
b2	3.0		3.40	0.118		0.134
c	0.40		0.80	0.015		0.03
D	19.85		20.15	0.781		0.793
E	15.45		15.75	0.608		0.620
e		5.45			0.214	
L	14.20		14.80	0.560		0.582
L1	3.70		4.30	0.14		0.17
L2		18.50			0.728	
øP	3.55		3.65	0.140		0.143
øR	4.50		5.50	0.177		0.216
S		5.50			0.216	

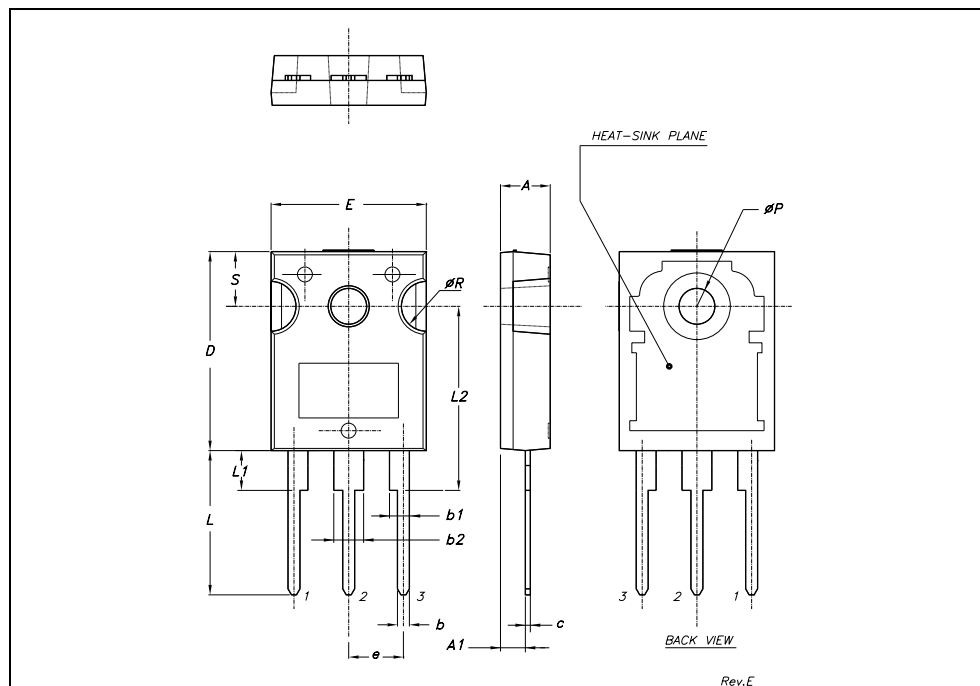

## 5 Revision history

**Table 9. Document revision history**

Date	Revision	Changes
23-Nov-2005	1	First issue.
17-Mar-2006	2	Complete version
05-May-2006	3	Modified value on <a href="#">Table 2.: Absolute maximum ratings</a>
30-May-2006	4	New values on <a href="#">Table 3: Thermal resistance</a>
23-Jun-2006	5	Modified value on <a href="#">Table 4.: Static</a>
07-Sep-2006	6	Modified T <sub>J</sub> temperature range to 150°C in <a href="#">Table 2.: Absolute maximum ratings</a>
14-Nov-2006	7	Modified <a href="#">Figure 5.</a> and <a href="#">Figure 9.</a>
26-Jan-2007	8	Typing error on first page.
04-Oct-2007	9	Modified test conditions in <a href="#">Table 4.: Static</a>

**Please Read Carefully:**

Information in this document is provided solely in connection with ST products. STMicroelectronics NV and its subsidiaries ("ST") reserve the right to make changes, corrections, modifications or improvements, to this document, and the products and services described herein at any time, without notice.

All ST products are sold pursuant to ST's terms and conditions of sale.

Purchasers are solely responsible for the choice, selection and use of the ST products and services described herein, and ST assumes no liability whatsoever relating to the choice, selection or use of the ST products and services described herein.

No license, express or implied, by estoppel or otherwise, to any intellectual property rights is granted under this document. If any part of this document refers to any third party products or services it shall not be deemed a license grant by ST for the use of such third party products or services, or any intellectual property contained therein or considered as a warranty covering the use in any manner whatsoever of such third party products or services or any intellectual property contained therein.

**UNLESS OTHERWISE SET FORTH IN ST'S TERMS AND CONDITIONS OF SALE ST DISCLAIMS ANY EXPRESS OR IMPLIED WARRANTY WITH RESPECT TO THE USE AND/OR SALE OF ST PRODUCTS INCLUDING WITHOUT LIMITATION IMPLIED WARRANTIES OF MERCHANTABILITY, FITNESS FOR A PARTICULAR PURPOSE (AND THEIR EQUIVALENTS UNDER THE LAWS OF ANY JURISDICTION), OR INFRINGEMENT OF ANY PATENT, COPYRIGHT OR OTHER INTELLECTUAL PROPERTY RIGHT.**

**UNLESS EXPRESSLY APPROVED IN WRITING BY AN AUTHORIZED ST REPRESENTATIVE, ST PRODUCTS ARE NOT RECOMMENDED, AUTHORIZED OR WARRANTED FOR USE IN MILITARY, AIR CRAFT, SPACE, LIFE SAVING, OR LIFE SUSTAINING APPLICATIONS, NOR IN PRODUCTS OR SYSTEMS WHERE FAILURE OR MALFUNCTION MAY RESULT IN PERSONAL INJURY, DEATH, OR SEVERE PROPERTY OR ENVIRONMENTAL DAMAGE. ST PRODUCTS WHICH ARE NOT SPECIFIED AS "AUTOMOTIVE GRADE" MAY ONLY BE USED IN AUTOMOTIVE APPLICATIONS AT USER'S OWN RISK.**

Resale of ST products with provisions different from the statements and/or technical features set forth in this document shall immediately void any warranty granted by ST for the ST product or service described herein and shall not create or extend in any manner whatsoever, any liability of ST.

ST and the ST logo are trademarks or registered trademarks of ST in various countries.

Information in this document supersedes and replaces all information previously supplied.

The ST logo is a registered trademark of STMicroelectronics. All other names are the property of their respective owners.

© 2007 STMicroelectronics - All rights reserved

STMicroelectronics group of companies

Australia - Belgium - Brazil - Canada - China - Czech Republic - Finland - France - Germany - Hong Kong - India - Israel - Italy - Japan - Malaysia - Malta - Morocco - Singapore - Spain - Sweden - Switzerland - United Kingdom - United States of America

[www.st.com](http://www.st.com)

# Mouser Electronics

Authorized Distributor

Click to View Pricing, Inventory, Delivery & Lifecycle Information:

[STMicroelectronics:](#)

[STGW30NC120HD](#)