

DTA114EET1 Series, SDTA114EET1 Series

Preferred Devices

Bias Resistor Transistors

PNP Silicon Surface Mount Transistors with Monolithic Bias Resistor Network

This new series of digital transistors is designed to replace a single device and its external resistor bias network. The Bias Resistor Transistor (BRT) contains a single transistor with a monolithic bias network consisting of two resistors; a series base resistor and a base-emitter resistor. The BRT eliminates these individual components by integrating them into a single device. The use of a BRT can reduce both system cost and board space. The device is housed in the SC-75/SOT-416 package which is designed for low power surface mount applications.

Features

- Simplifies Circuit Design
- Reduces Board Space
- Reduces Component Count
- The SC-75/SOT-416 package can be soldered using wave or reflow. The modified gull-winged leads absorb thermal stress during soldering eliminating the possibility of damage to the die.
- AEC-Q101 Qualified and PPAP Capable
- S Prefix for Automotive and Other Applications Requiring Unique Site and Control Change Requirements
- Pb-Free Packages are Available*

MAXIMUM RATINGS (T_A = 25°C unless otherwise noted)

Rating	Symbol	Value	Unit
Collector-Base Voltage	V _{CBO}	50	Vdc
Collector-Emitter Voltage	V _{CEO}	50	Vdc
Collector Current	I _C	100	mAdc

Stresses exceeding Maximum Ratings may damage the device. Maximum Ratings are stress ratings only. Functional operation above the Recommended Operating Conditions is not implied. Extended exposure to stresses above the Recommended Operating Conditions may affect device reliability.



ON Semiconductor®

<http://onsemi.com>

PNP SILICON BIAS RESISTOR TRANSISTORS



SC-75 (SOT-416)
CASE 463
STYLE 1

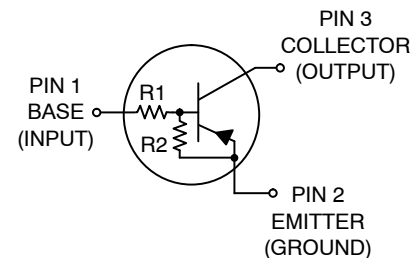

MARKING DIAGRAM

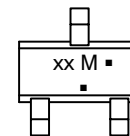

xx = Specific Device Code
xx = (Refer to page 4)

M = Date Code*

▪ = Pb-Free Package

(Note: Microdot may be in either location)

*Date Code orientation may vary depending upon manufacturing location.

ORDERING INFORMATION

See detailed ordering and shipping information in the package dimensions section on page 4 of this data sheet.

Preferred devices are recommended choices for future use and best overall value.

*For additional information on our Pb-Free strategy and soldering details, please download the ON Semiconductor Soldering and Mounting Techniques Reference Manual, SOLDERRM/D.

DTA114EET1 Series, SDTA114EET1 Series

THERMAL CHARACTERISTICS

Rating	Symbol	Value	Unit
Total Device Dissipation, FR-4 Board (Note 1) @ $T_A = 25^\circ\text{C}$ Derate above 25°C	P_D	200 1.6	mW mW/ $^\circ\text{C}$
Thermal Resistance, Junction-to-Ambient (Note 1)	$R_{\theta JA}$	600	$^\circ\text{C}/\text{W}$
Total Device Dissipation, FR-4 Board (Note 2) @ $T_A = 25^\circ\text{C}$ Derate above 25°C	P_D	300 2.4	mW mW/ $^\circ\text{C}$
Thermal Resistance, Junction-to-Ambient (Note 2)	$R_{\theta JA}$	400	$^\circ\text{C}/\text{W}$
Junction and Storage Temperature Range	T_J, T_{stg}	-55 to +150	$^\circ\text{C}$

1. FR-4 @ Minimum Pad.
2. FR-4 @ 1.0×1.0 Inch Pad.

ELECTRICAL CHARACTERISTICS ($T_A = 25^\circ\text{C}$ unless otherwise noted)

Characteristic	Symbol	Min	Typ	Max	Unit
----------------	--------	-----	-----	-----	------

OFF CHARACTERISTICS

Collector-Base Cutoff Current ($V_{CB} = 50\text{ V}, I_E = 0$)	I_{CBO}	-	-	100	nAdc
Collector-Emitter Cutoff Current ($V_{CE} = 50\text{ V}, I_B = 0$)	I_{CEO}	-	-	500	nAdc
Emitter-Base Cutoff Current ($V_{EB} = 6.0\text{ V}, I_C = 0$)	I_{EBO}				mAdc
DTA114EET1		-	-	0.5	
DTA124EET1		-	-	0.2	
DTA144EET1		-	-	0.1	
DTA114YET1, SDTA114YET1		-	-	0.2	
DTA114TET1		-	-	0.9	
DTA143TET1		-	-	1.9	
DTA123EET1		-	-	2.3	
DTA143EET1		-	-	1.5	
DTA143ZET1		-	-	0.18	
DTA124XET1		-	-	0.13	
DTA123JET1		-	-	0.2	
DTA115EET1		-	-	0.05	
DTA144WET1		-	-	0.13	
Collector-Base Breakdown Voltage ($I_C = 10\ \mu\text{A}, I_E = 0$)	$V_{(BR)CBO}$	50	-	-	Vdc
Collector-Emitter Breakdown Voltage (Note 3) ($I_C = 2.0\text{ mA}, I_B = 0$)	$V_{(BR)CEO}$	50	-	-	Vdc

3. Pulse Test: Pulse Width < $300\ \mu\text{s}$, Duty Cycle < 2.0%

ELECTRICAL CHARACTERISTICS ($T_A = 25^\circ\text{C}$ unless otherwise noted)

Characteristic	Symbol	Min	Typ	Max	Unit
----------------	--------	-----	-----	-----	------

ON CHARACTERISTICS (Note 4)

DC Current Gain ($V_{CE} = 10\text{ V}, I_C = 5.0\text{ mA}$)	h_{FE}				-
DTA114EET1		35	60	-	
DTA124EET1		60	100	-	
DTA144EET1		80	140	-	
DTA114YET1, SDTA114YET1		80	140	-	
DTA114TET1		160	250	-	
DTA143TET1		160	250	-	
DTA123EET1		8.0	15	-	
DTA143EET1		15	27	-	
DTA143ZET1		80	140	-	
DTA124XET1		80	130	-	
DTA123JET1		80	140	-	
DTA115EET1		80	150	-	
DTA144WET1		80	140	-	

DTA114EET1 Series, SDTA114EET1 Series

ORDERING INFORMATION AND RESISTOR VALUES

Device	Marking	R1 (K)	R2 (K)	Package	Shipping†
DTA114EET1	6A	10	10	SC-75	3,000 Tape & Reel
DTA114EET1G				SC-75 (Pb-Free)	3,000 Tape & Reel
DTA124EET1	6B	22	22	SC-75	3,000 Tape & Reel
DTA124EET1G				SC-75 (Pb-Free)	3,000 Tape & Reel
DTA144EET1	6C	47	47	SC-75	3,000 Tape & Reel
DTA144EET1G				SC-75 (Pb-Free)	3,000 Tape & Reel
DTA114YET1	6D	10	47	SC-75	3,000 Tape & Reel
DTA114YET1G				SC-75 (Pb-Free)	3,000 Tape & Reel
SDTA114YET1G				SC-75 (Pb-Free)	3,000 Tape & Reel
DTA114TET1	6E	10	∞	SC-75	3,000 Tape & Reel
DTA114TET1G				SC-75 (Pb-Free)	3,000 Tape & Reel
DTA143TET1	6F	4.7	∞	SC-75	3,000 Tape & Reel
DTA143TET1G				SC-75 (Pb-Free)	3,000 Tape & Reel
DTA123EET1	6H	2.2	2.2	SC-75	3,000 Tape & Reel
DTA123EET1G				SC-75 (Pb-Free)	3,000 Tape & Reel
DTA143EET1	43	4.7	4.7	SC-75	3,000 Tape & Reel
DTA143EET1G				SC-75 (Pb-Free)	3,000 Tape & Reel
DTA143ZET1	6K	4.7	47	SC-75	3,000 Tape & Reel
DTA143ZET1G				SC-75 (Pb-Free)	3,000 Tape & Reel
DTA124XET1	6L	22	47	SC-75	3,000 Tape & Reel
DTA124XET1G				SC-75 (Pb-Free)	3,000 Tape & Reel
DTA123JET1	6M	2.2	47	SC-75	3,000 Tape & Reel
DTA123JET1G				SC-75 (Pb-Free)	3,000 Tape & Reel
DTA115EET1	6N	100	100	SC-75	3,000 Tape & Reel
DTA115EET1G				SC-75 (Pb-Free)	3,000 Tape & Reel
DTA144WET1	6P	47	22	SC-75	3,000 Tape & Reel
DTA144WET1G				SC-75 (Pb-Free)	3,000 Tape & Reel

†For information on tape and reel specifications, including part orientation and tape sizes, please refer to our Tape and Reel Packaging Specifications Brochure, BRD8011/D.

DTA114EET1 Series, SDTA114EET1 Series

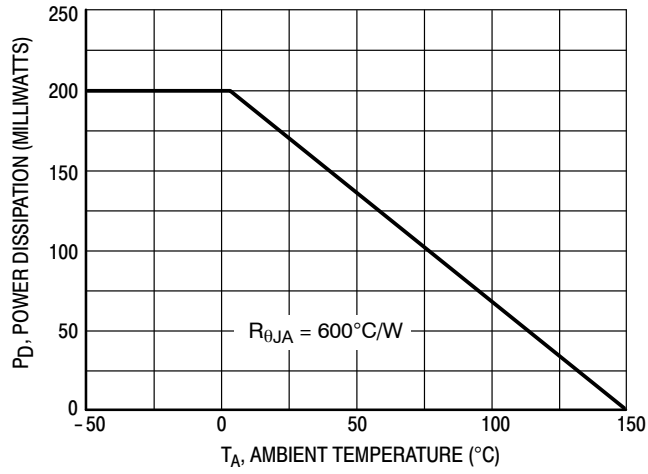

Figure 1. Derating Curve

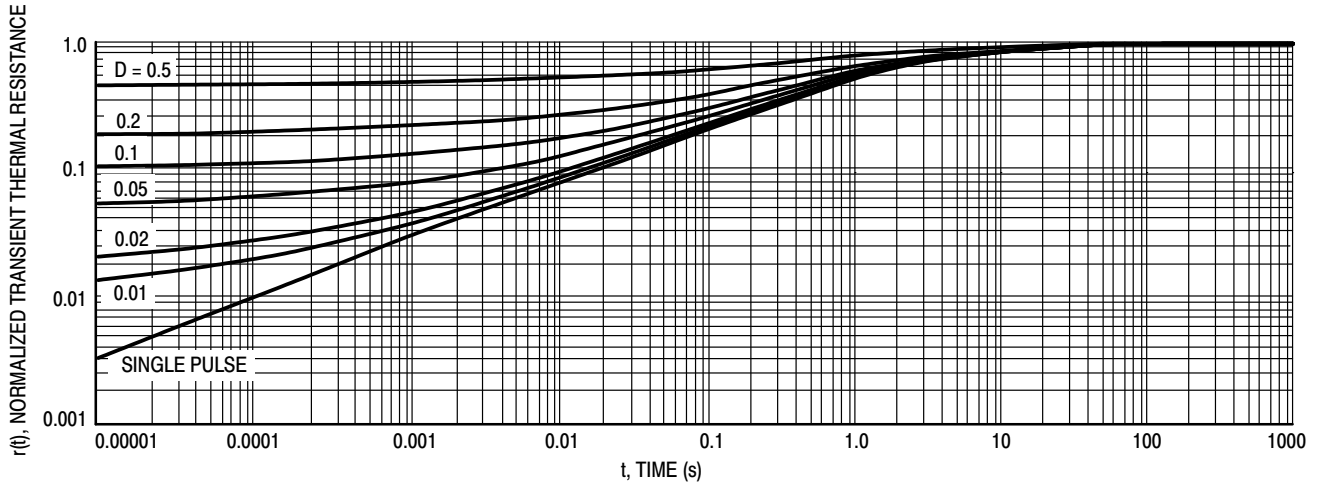

Figure 2. Normalized Thermal Response

DTA114EET1 Series, SDTA114EET1 Series

TYPICAL ELECTRICAL CHARACTERISTICS - DTA114EET1

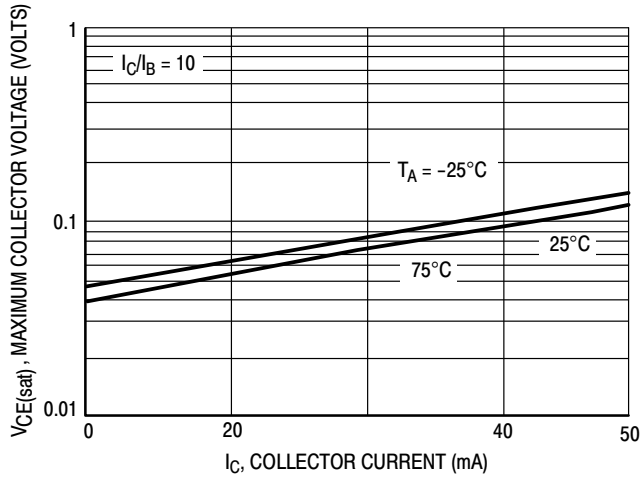

Figure 3. $V_{CE(sat)}$ versus I_C

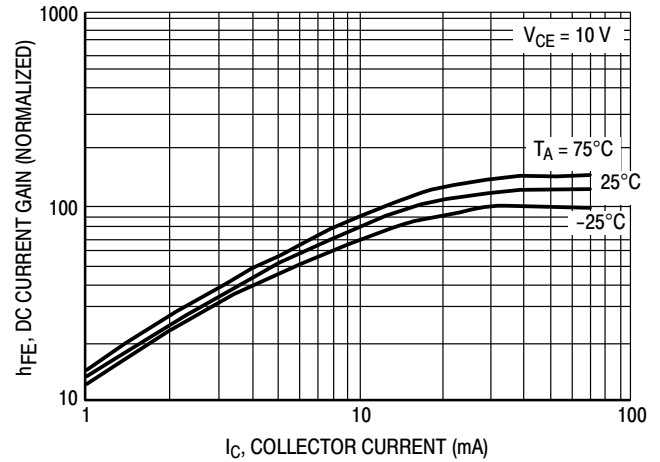

Figure 4. DC Current Gain

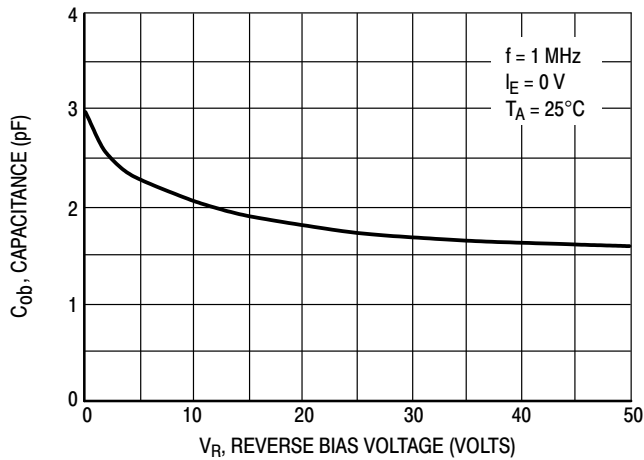

Figure 5. Output Capacitance

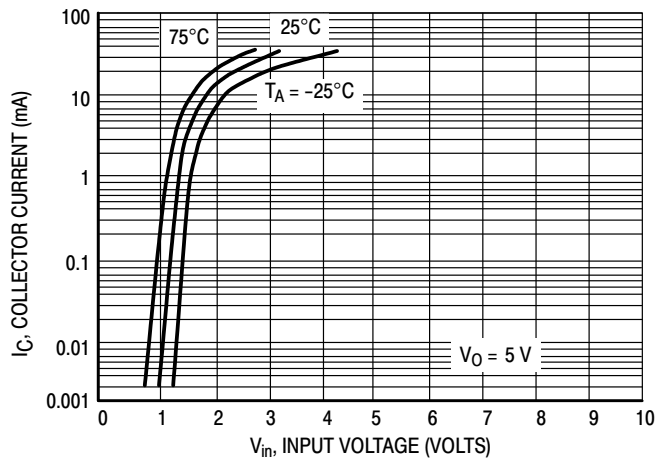

Figure 6. Output Current versus Input Voltage

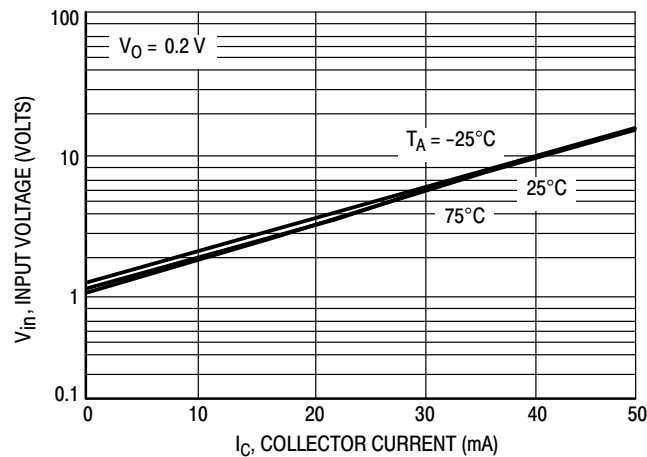

Figure 7. Input Voltage versus Output Current

TYPICAL ELECTRICAL CHARACTERISTICS - DTA123EET1

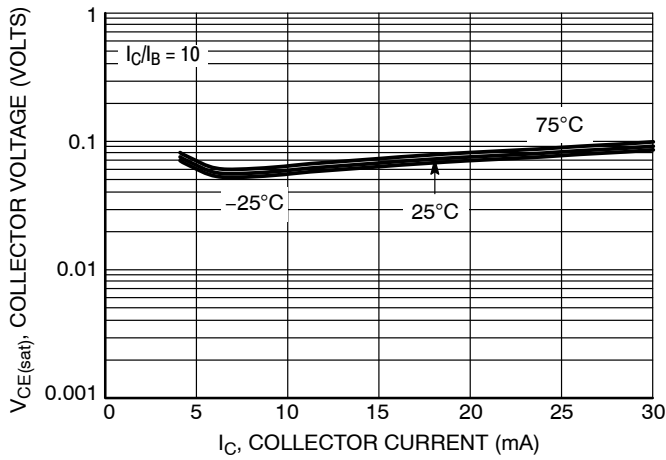

Figure 8. $V_{CE(sat)}$ versus I_C

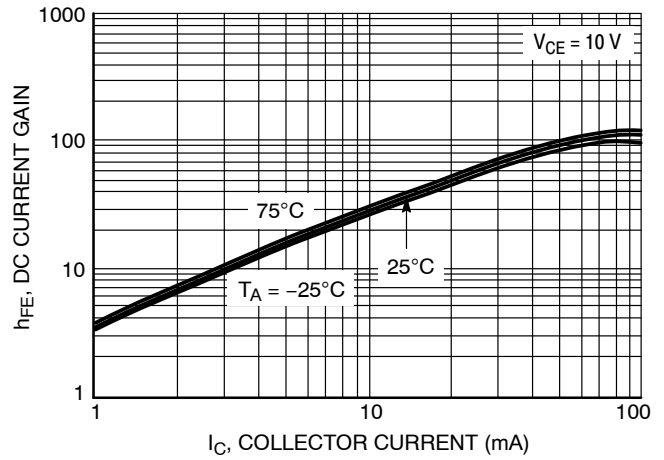

Figure 9. DC Current Gain

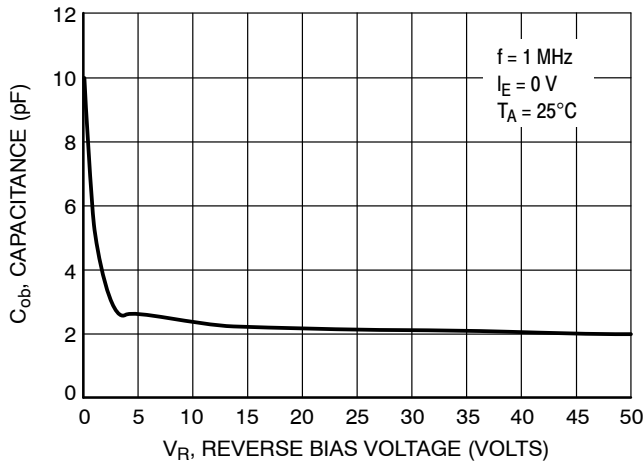

Figure 10. Output Capacitance

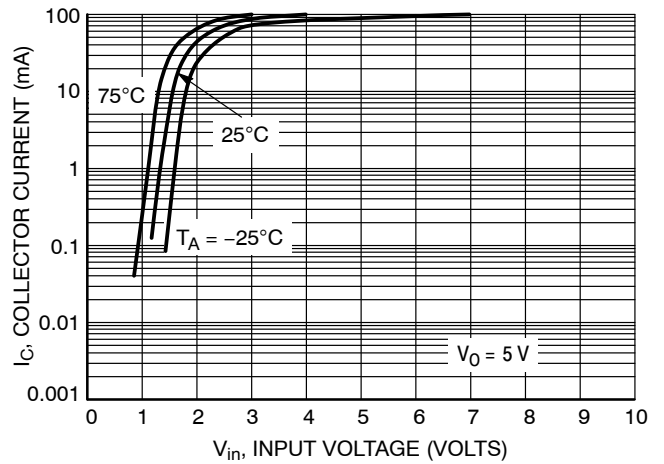

Figure 11. Output Current versus Input Voltage

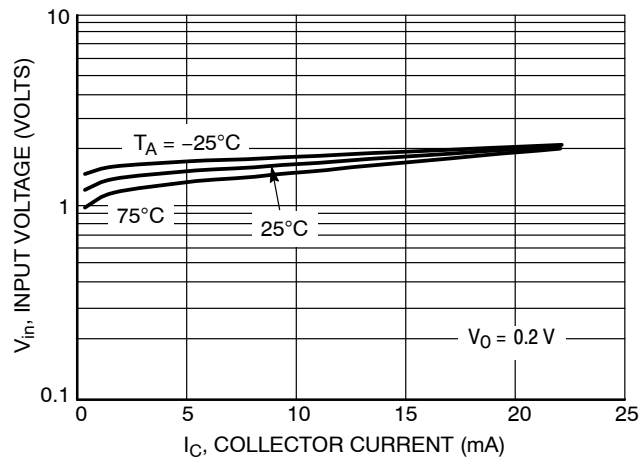

Figure 12. Input Voltage versus Output Current

DTA114EET1 Series, SDTA114EET1 Series

TYPICAL ELECTRICAL CHARACTERISTICS - DTA124EET1

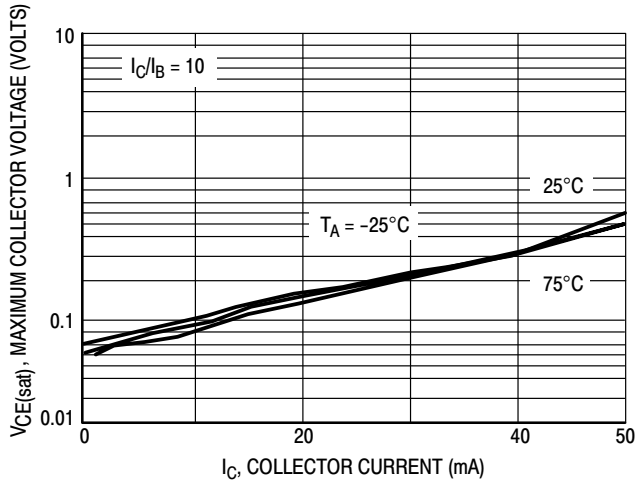

Figure 13. $V_{CE(sat)}$ versus I_C

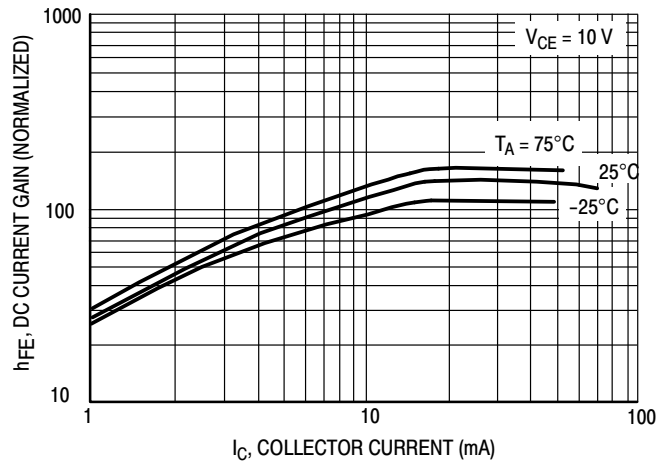

Figure 14. DC Current Gain

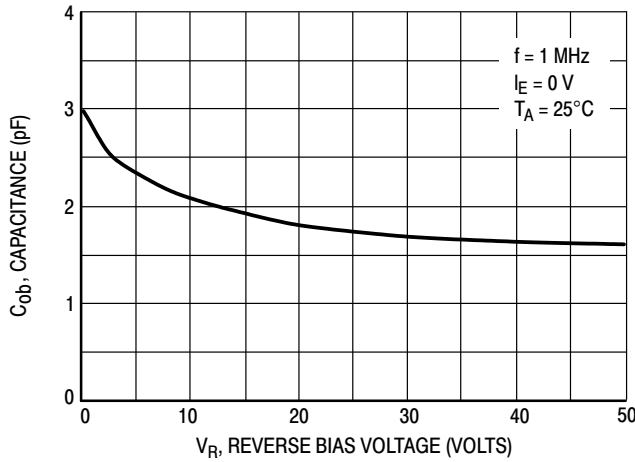

Figure 15. Output Capacitance

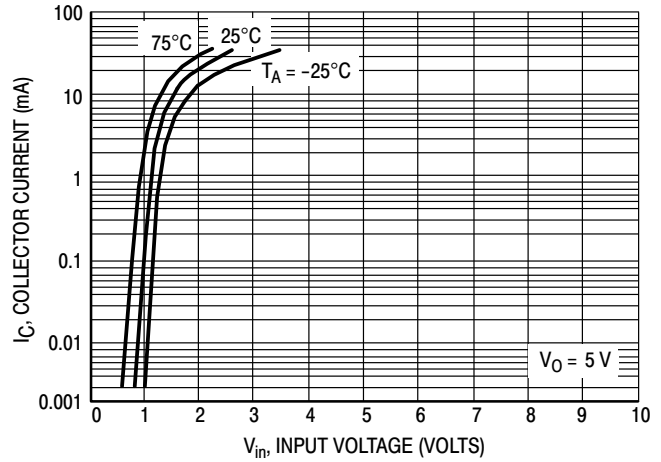

Figure 16. Output Current versus Input Voltage

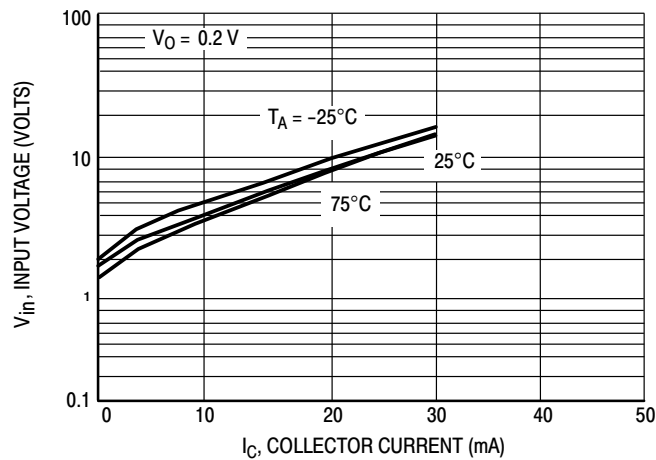

Figure 17. Input Voltage versus Output Current

DTA114EET1 Series, SDTA114EET1 Series

TYPICAL ELECTRICAL CHARACTERISTICS - DTA144EET1

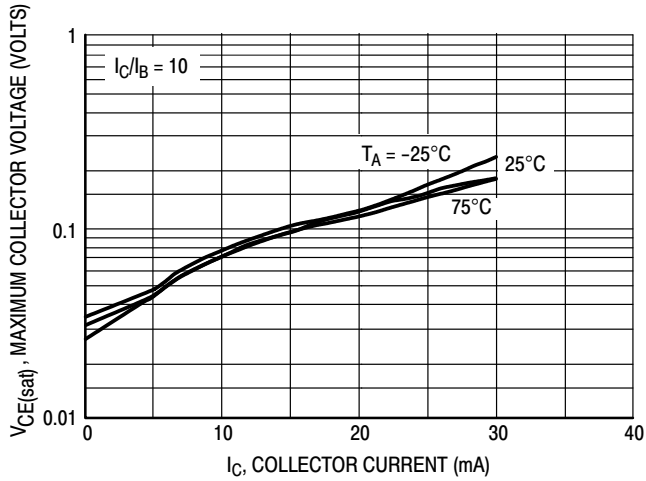

Figure 18. $V_{CE(sat)}$ versus I_C

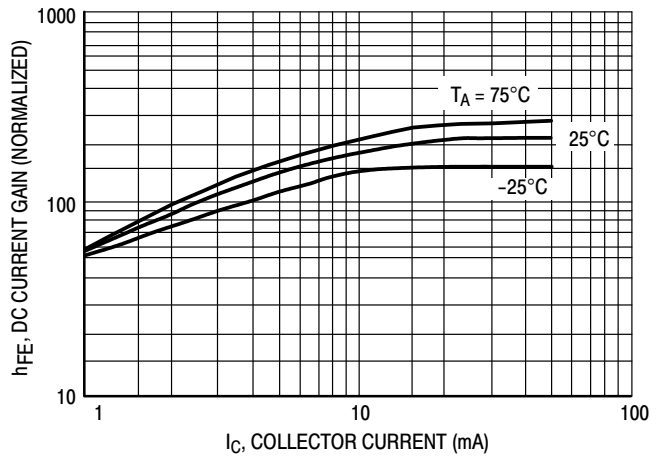

Figure 19. DC Current Gain

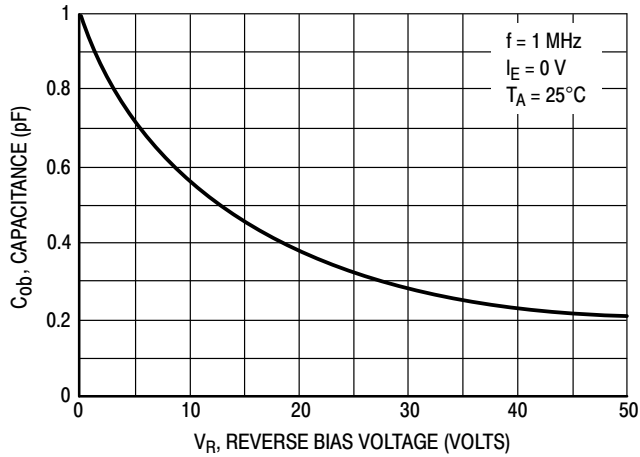

Figure 20. Output Capacitance

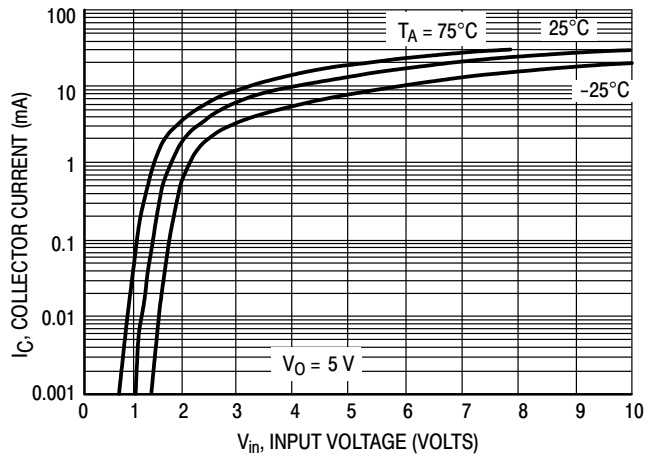

Figure 21. Output Current versus Input Voltage

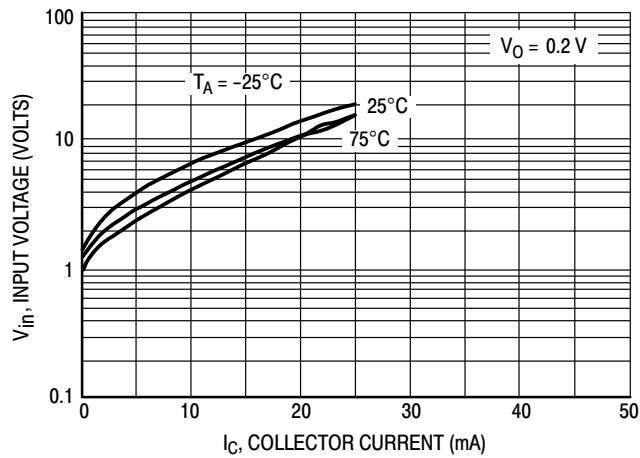

Figure 22. Input Voltage versus Output Current

TYPICAL ELECTRICAL CHARACTERISTICS – DTA114YET1, SDTA114YET1

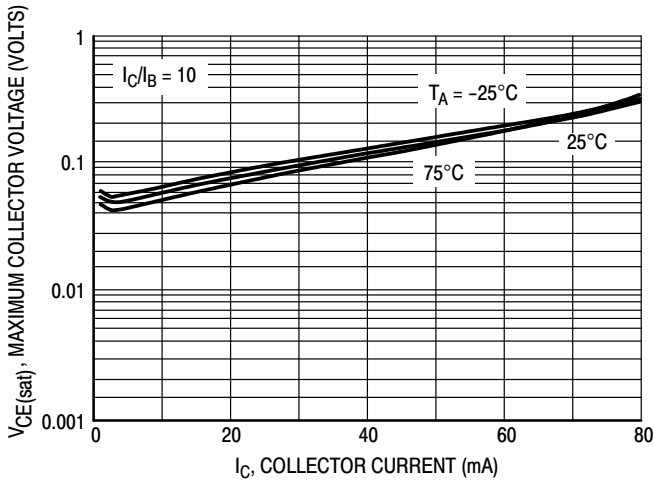

Figure 23. $V_{CE(sat)}$ versus I_C

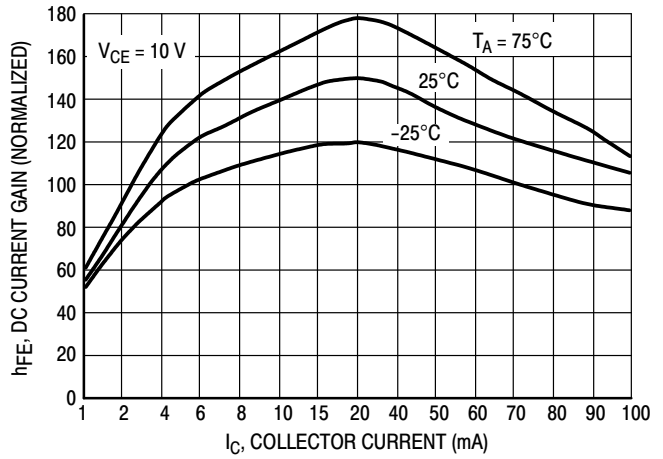

Figure 24. DC Current Gain

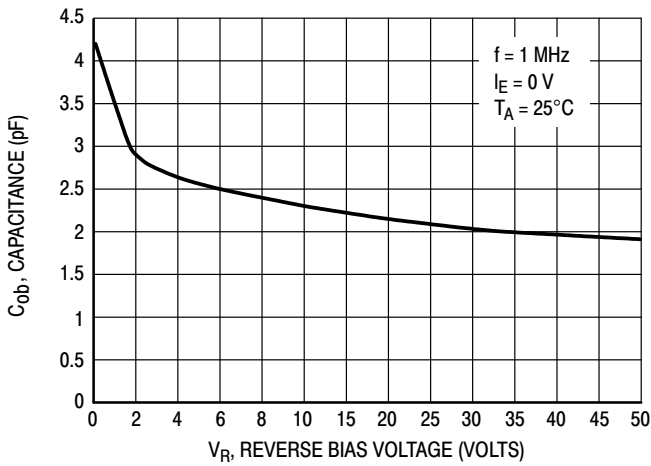

Figure 25. Output Capacitance

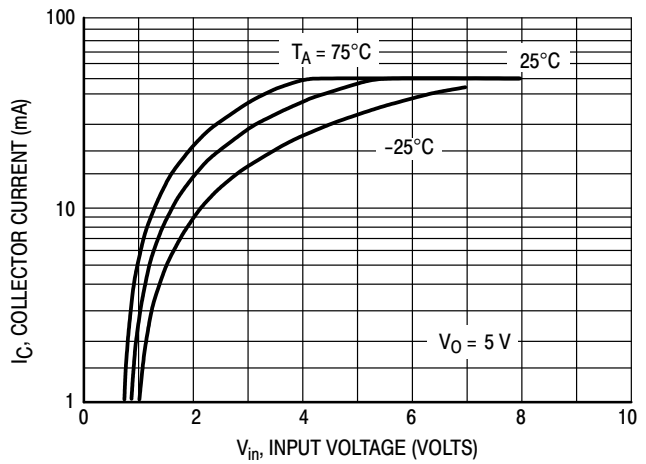

Figure 26. Output Current versus Input Voltage

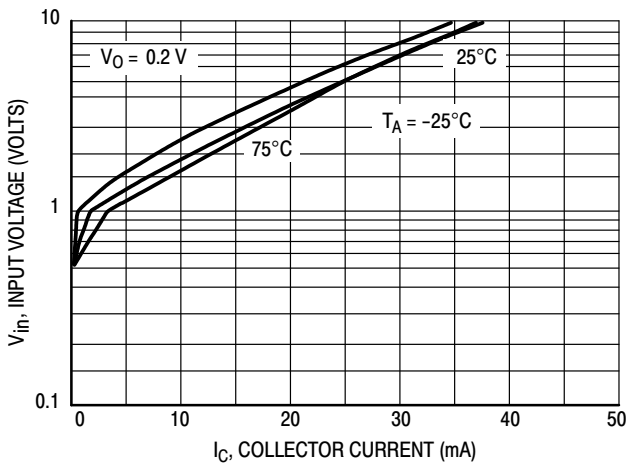

Figure 27. Input Voltage versus Output Current

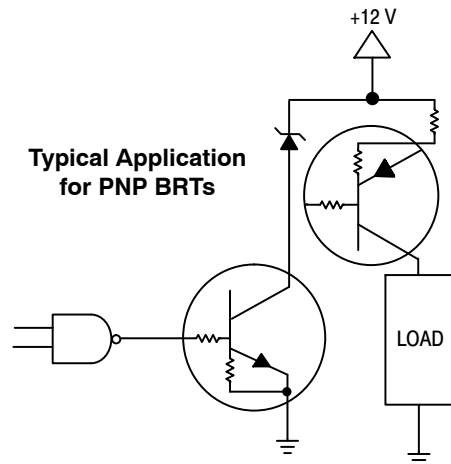

Figure 28. Inexpensive, Unregulated Current Source

TYPICAL ELECTRICAL CHARACTERISTICS — DTA115EET1

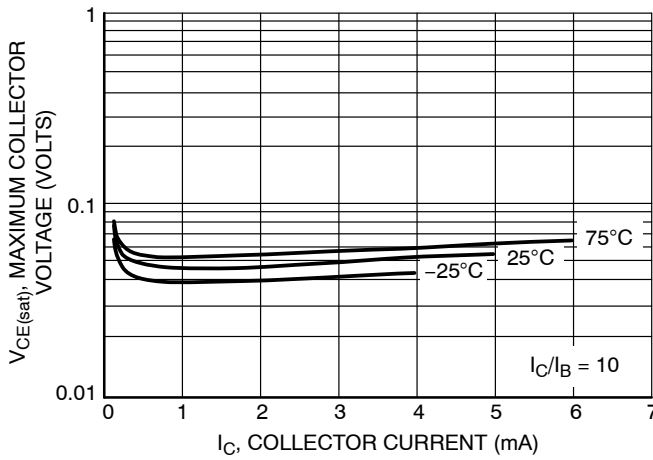

Figure 29. Maximum Collector Voltage versus Collector Current

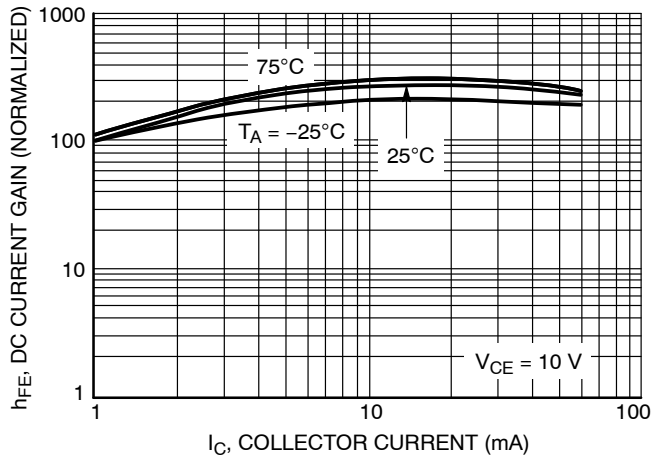

Figure 30. DC Current Gain

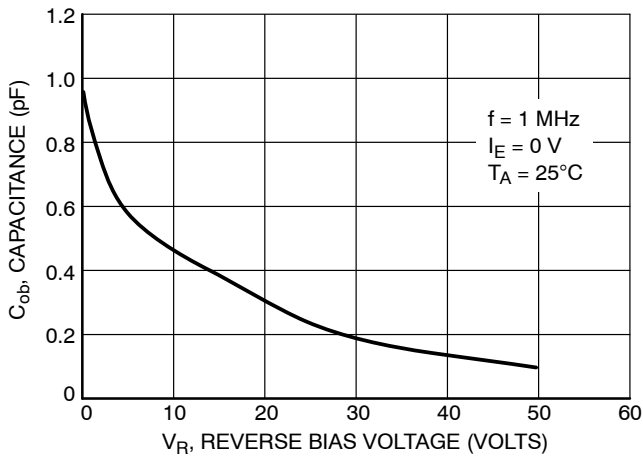

Figure 31. Output Capacitance

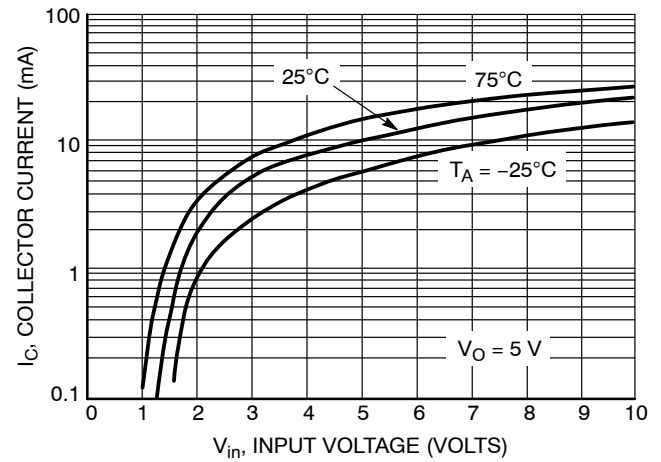

Figure 32. Output Current versus Input Voltage

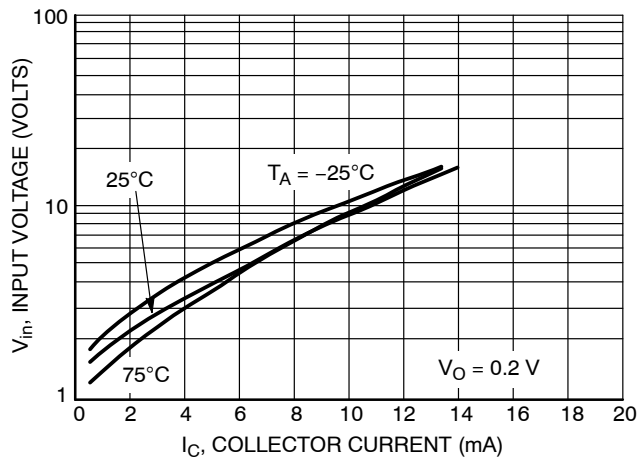

Figure 33. Input Voltage versus Output Current

TYPICAL ELECTRICAL CHARACTERISTICS — DTA144WET1

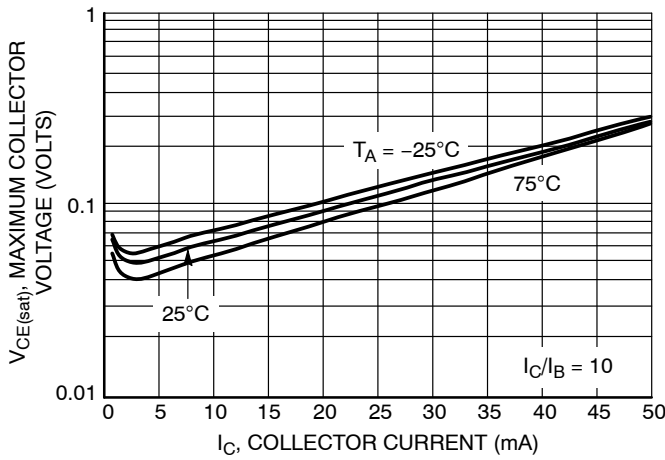

Figure 34. Maximum Collector Voltage versus Collector Current

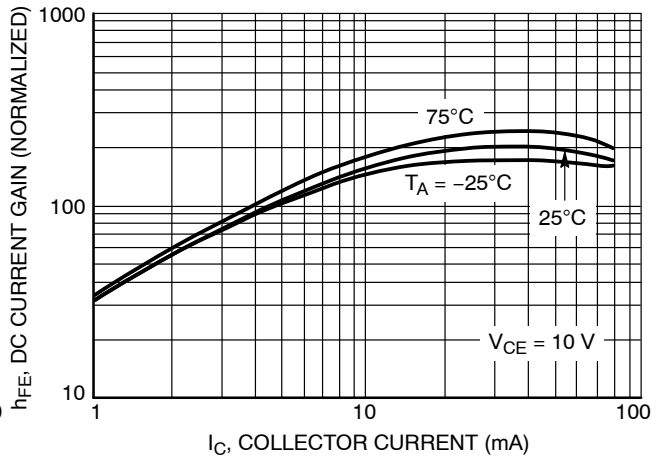

Figure 35. DC Current Gain

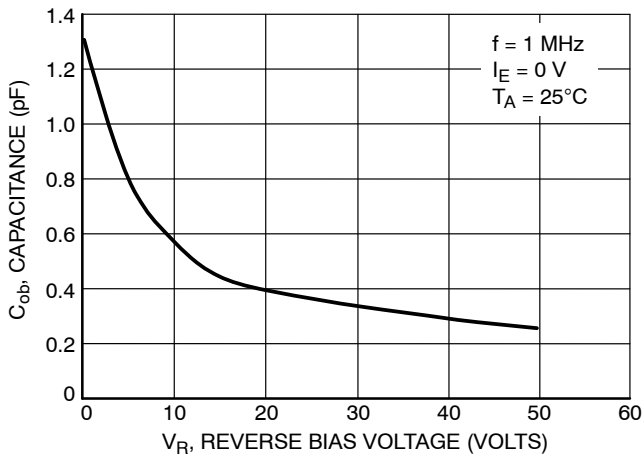

Figure 36. Output Capacitance

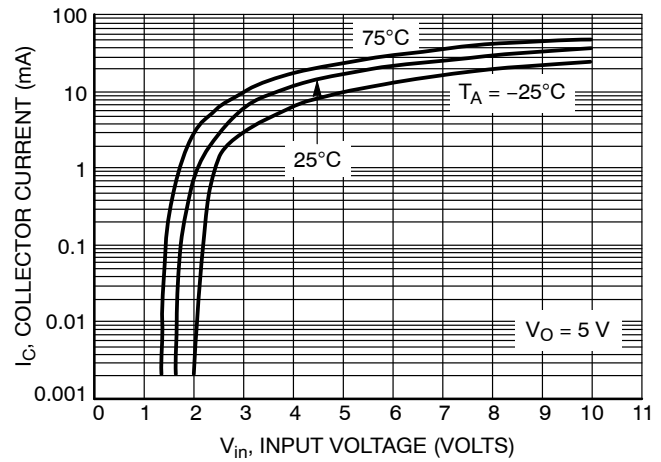

Figure 37. Output Current versus Input Voltage

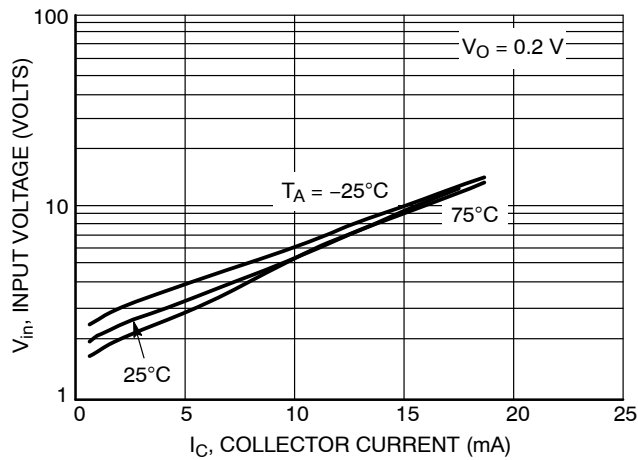
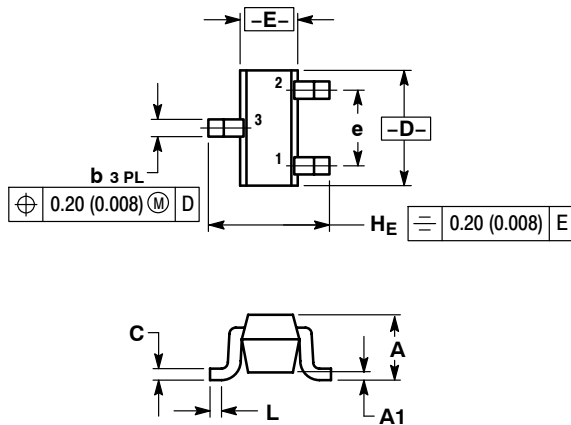

Figure 38. Input Voltage versus Output Current

DTA114EET1 Series, SDTA114EET1 Series

PACKAGE DIMENSIONS

SC-75/SOT-416
CASE 463-01
ISSUE F



- NOTES:
1. DIMENSIONING AND TOLERANCING PER ANSI Y14.5M, 1982.
2. CONTROLLING DIMENSION: MILLIMETER.

DIM	MILLIMETERS			INCHES		
	MIN	NOM	MAX	MIN	NOM	MAX
A	0.70	0.80	0.90	0.027	0.031	0.035
A1	0.00	0.05	0.10	0.000	0.002	0.004
b	0.15	0.20	0.30	0.006	0.008	0.012
C	0.10	0.15	0.25	0.004	0.006	0.010
D	1.55	1.60	1.65	0.059	0.063	0.067
E	0.70	0.80	0.90	0.027	0.031	0.035
e	1.00 BSC			0.04 BSC		
L	0.10	0.15	0.20	0.004	0.006	0.008
H _E	1.50	1.60	1.70	0.061	0.063	0.065

- STYLE 1:
PIN 1. BASE
2. EMITTER
3. COLLECTOR

SOLDERING FOOTPRINT*

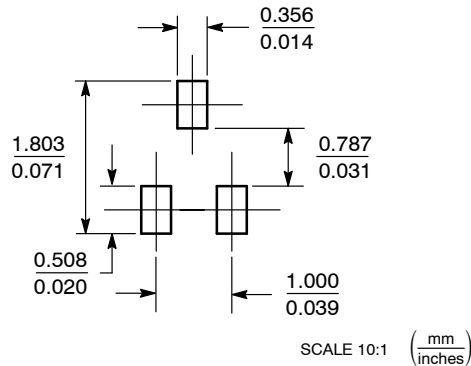

*For additional information on our Pb-Free strategy and soldering details, please download the ON Semiconductor Soldering and Mounting Techniques Reference Manual, SOLDERRM/D.

ON Semiconductor and are registered trademarks of Semiconductor Components Industries, LLC (SCILLC). SCILLC reserves the right to make changes without further notice to any products herein. SCILLC makes no warranty, representation or guarantee regarding the suitability of its products for any particular purpose, nor does SCILLC assume any liability arising out of the application or use of any product or circuit, and specifically disclaims any and all liability, including without limitation special, consequential or incidental damages. "Typical" parameters which may be provided in SCILLC data sheets and/or specifications can and do vary in different applications and actual performance may vary over time. All operating parameters, including "Typicals" must be validated for each customer application by customer's technical experts. SCILLC does not convey any license under its patent rights nor the rights of others. SCILLC products are not designed, intended, or authorized for use as components in systems intended for surgical implant into the body, or other applications intended to support or sustain life, or for any other application in which the failure of the SCILLC product could create a situation where personal injury or death may occur. Should Buyer purchase or use SCILLC products for any such unintended or unauthorized application, Buyer shall indemnify and hold SCILLC and its officers, employees, subsidiaries, affiliates, and distributors harmless against all claims, costs, damages, and expenses, and reasonable attorney fees arising out of, directly or indirectly, any claim of personal injury or death associated with such unintended or unauthorized use, even if such claim alleges that SCILLC was negligent regarding the design or manufacture of the part. SCILLC is an Equal Opportunity/Affirmative Action Employer. This literature is subject to all applicable copyright laws and is not for resale in any manner.

PUBLICATION ORDERING INFORMATION

LITERATURE FULFILLMENT:
Literature Distribution Center for ON Semiconductor
P.O. Box 5163, Denver, Colorado 80217 USA
Phone: 303-675-2175 or 800-344-3860 Toll Free USA/Canada
Fax: 303-675-2176 or 800-344-3867 Toll Free USA/Canada
Email: orderlit@onsemi.com

N. American Technical Support: 800-282-9855 Toll Free
USA/Canada
Europe, Middle East and Africa Technical Support:
Phone: 421 33 790 2910
Japan Customer Focus Center
Phone: 81-3-5817-1050

ON Semiconductor Website: www.onsemi.com
Order Literature: <http://www.onsemi.com/orderlit>
For additional information, please contact your local Sales Representative

Mouser Electronics

Authorized Distributor

Click to View Pricing, Inventory, Delivery & Lifecycle Information:

[ON Semiconductor:](#)

[SDTA114YET1G](#)