

RoHS HF 437 Series – 1206 Fast-Acting Fuse

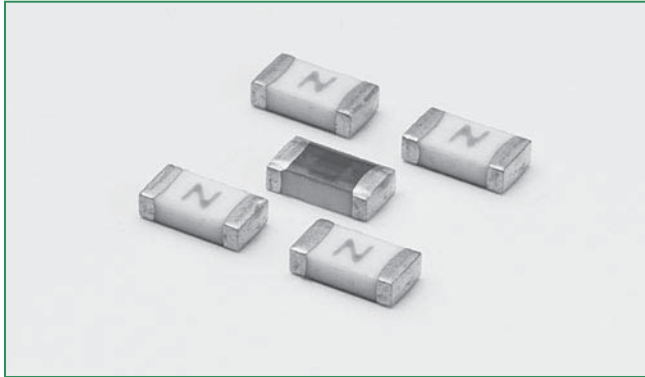



Description

This 100% Lead-free, RoHS compliant and Halogen-free fuse series has been designed specifically to provide over current protection to circuits that see high working ambient temperatures (up to 150°C).

The general design ensures excellent temperature stability and performance reliability.

In addition to this, the high I²t values typical of the Littelfuse Ceramic Fuse family ensure high inrush current withstand capability.

Agency Approvals

| AGENCY | AGENCY FILE NUMBER | AMPERE RANGE |
|---|--------------------|--------------|
|  | E10480 | 0.250A ~ 8A |
|  | LR29862 | 0.250A ~ 8A |

Features

- Operating Temperature from -55°C to +150°C
- Suitable for both leaded and lead-free reflow / wave soldering
- 100% Lead-free and RoHS compliant



Electrical Characteristics for Series

| % of Ampere Rating | Ampere Rating | Opening Time at 25°C |
|--------------------|---------------|----------------------|
| 100% | 250mA - 8A | 4 hours, Minimum |
| 250% | 750mA - 8A | 5 seconds, Maximum |
| 350% | 250mA - 500mA | 5 seconds, Maximum |
| 350% | 750mA - 8A | 1 second, Maximum |

Applications

- Automotive Electronics
- LCD Displays
- Servers
- Printers
- Scanners
- Data Modems

Electrical Specifications by Item

| Ampere Rating (A) | Amp Code | Max. Voltage Rating (V) | Interrupting Rating | Nominal Resistance (Ohms) ² | Nominal Melting I ² t (A ² Sec.) ³ | Nominal Voltage Drop At Rated Current (V) ⁴ | Nominal Power Dissipation At Rated Current (W) | Agency Approvals | |
|-------------------|----------|-------------------------|------------------------|--|---|--|--|---|---|
| | | | | | | | |  |  |
| 250mA | .250 | 125 | 50 A @ 125 V AC/DC | 2.290 | 0.003 | 0.78 | 0.195 | x | x |
| 375mA | .375 | 125 | | 1.330 | 0.010 | 0.60 | 0.225 | x | x |
| 500mA | .500 | 63 | | 0.908 | 0.018 | 0.52 | 0.260 | x | x |
| 750mA | .750 | 63 | 50 A @ 63 V AC/DC | 0.665 | 0.064 | 0.45 | 0.335 | x | x |
| 1A | 001. | 63 | | 0.360 | 0.100 | 0.41 | 0.415 | x | x |
| 1.25A | 1.25 | 63 | | 0.318 | 0.256 | 0.40 | 0.496 | x | x |
| 1.5A | 01.5 | 63 | | 0.209 | 0.324 | 0.39 | 0.579 | x | x |
| 1.75A | 1.75 | 63 | | 0.0703 | 0.075 | 0.27 | 0.474 | x | x |
| 2A | 002. | 63 | | 0.058 | 0.144 | 0.17 | 0.345 | x | x |
| 2.5A | 02.5 | 32 | 50 A @ 32 V AC/35 V DC | 0.043 | 0.225 | 0.14 | 0.363 | x | x |
| 3A | 003. | 32 | | 0.033 | 0.400 | 0.15 | 0.462 | x | x |
| 3.5A | 03.5 | 32 | | 0.027 | 0.576 | 0.16 | 0.560 | x | x |
| 4A | 004. | 32 | | 0.022 | 1.024 | 0.16 | 0.618 | x | x |
| 5A | 005. | 32 | | 0.016 | 1.936 | 0.09 | 0.484 | x | x |
| 7A | 007. | 32 | | 0.010 | 4.900 | 0.11 | 0.760 | x | x |
| 8A | 008. | 32 | | 0.0084 | 6.400 | 0.067 | 0.539 | x | x |

Notes:

1. AC Interrupting Rating tested at rated voltage with unity power factor. DC Interrupting Rating tested at rated voltage with time constant < 0.8 msec.
2. Nominal Resistance measured with < 10% rated current.
3. Nominal Melting I²t measured at 1 msec. opening time.
4. Nominal Voltage Drop measured at rated current after temperature has stabilized.

Devices designed to carry rated current for 4 hours minimum. It is recommended that devices be operated continuously at no more than 80% rated current. See "Temperature Derating Curve" for additional derating information.

Devices designed to be mounted with marking code facing up.

Temperature Derating Curve

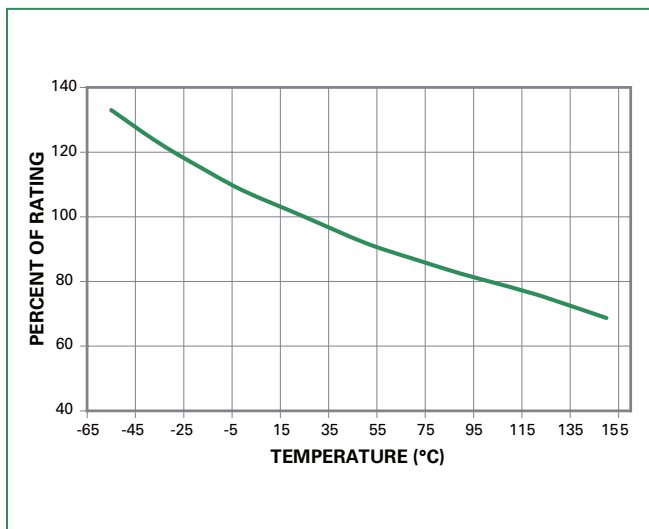

Note:

1. Derating depicted in this curve is in addition to the standard derating of 20% for continuous operation.

Example:

For continuous operation at 75 degrees celsius, the fuse should be derated as follows:

$$I = (0.80)(0.85)_{RAT} = (0.68)_{RAT}$$

Average Time Current Curves

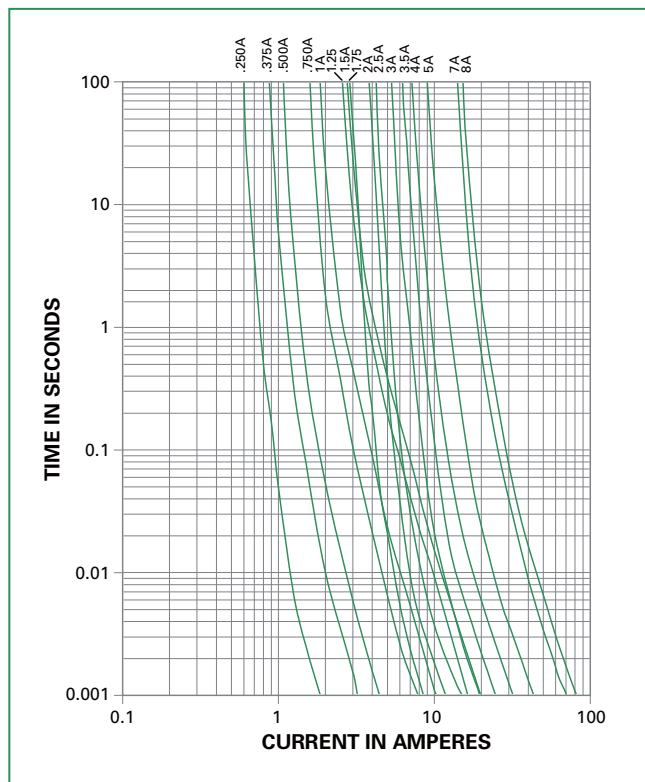

Soldering Parameters

| | | |
|--|------------------------------------|------------------|
| Reflow Condition | Pb – free assembly | |
| Pre Heat | - Temperature Min ($T_{s(min)}$) | 150°C |
| | - Temperature Max ($T_{s(max)}$) | 200°C |
| | - Time (Min to Max) (t_s) | 60 – 180 seconds |
| Average Ramp-up Rate (Liquidus Temp (T_L) to peak) | 3°C/second max. | |
| $T_{s(max)}$ to T_L - Ramp-up Rate | 5°C/second max. | |
| Reflow | - Temperature (T_L) (Liquidus) | 217°C |
| | - Temperature (t_L) | 60 – 150 seconds |
| Peak Temperature (T_p) | 260 ^{+0/-5} °C | |
| Time within 5°C of actual peak Temperature (t_p) | 10 – 30 seconds | |
| Ramp-down Rate | 6°C/second max. | |
| Time 25°C to peak Temperature (T_p) | 8 minutes max. | |
| Do not exceed | 260°C | |

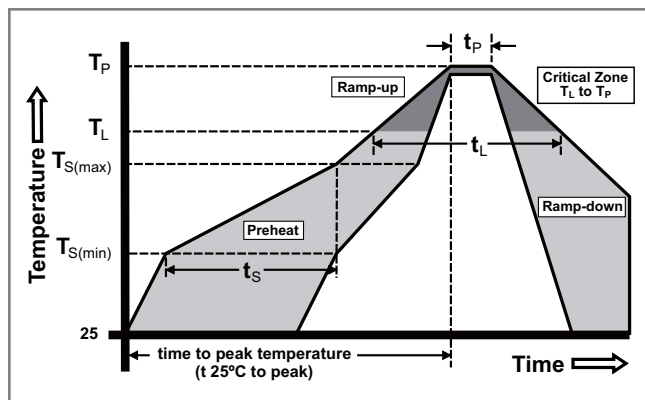

| | |
|----------------|------------------------|
| Wave Soldering | 260°C, 10 seconds max. |
|----------------|------------------------|

Product Characteristics

| | |
|-----------------------------------|--|
| Materials | Body: Advanced Ceramic Terminations: Ag / Ni / Sn (100% Lead-free) Element Cover Coating: Lead-free Glass |
| Moisture Sensitivity Level | IPC/JEDEC J-STD-020C, Level 1 |
| Solderability | IPC/EIC/JEDEC J-STD-002B, Condition B |
| Humidity Test | MIL-STD-202, Method 103B, Conditions D |
| ESD Immunity | IEC 61000-4-2, 8kV Direct |
| Resistance to Solder Heat | MIL-STD-202, Method 210F, Condition B |

| | |
|-------------------------------------|---------------------------------------|
| Moisture Resistance | MIL-STD-202, Method 106G |
| Thermal Shock | MIL-STD-202, Method 107G, Condition B |
| Mechanical Shock | MIL-STD-202, Method 213B, Condition A |
| Vibration | MIL-STD-202, Method 201A |
| Vibration, High Frequency | MIL-STD-202, Method 204D, Condition D |
| Dissolution of Metallization | IPC/EIC/JEDEC J-STD-002B, Condition D |
| Terminal Strength | IEC 60127-4 |

Dimensions

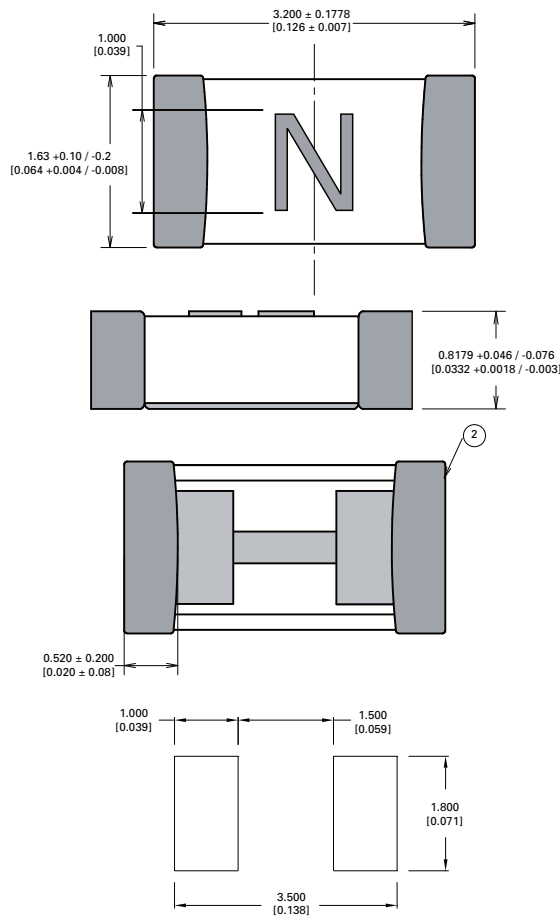

Part Marking System

| Amp Code | Marking Code |
|----------|--------------|
| .250 | D |
| .375 | E |
| .500 | F |
| .750 | G |
| 001. | H |
| 1.25 | J |
| 01.5 | K |
| 1.75 | L |
| 002. | N |
| 02.5 | O |
| 003. | P |
| 03.5 | R |
| 004. | S |
| 005. | T |
| 007. | W |
| 008. | X |

Part Numbering System

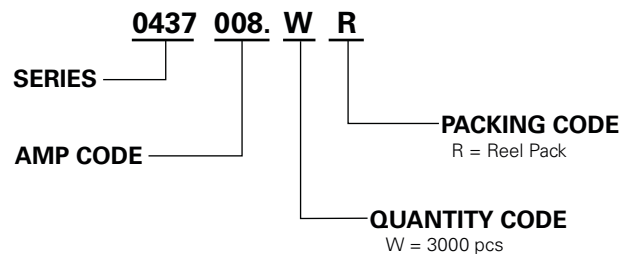

Packaging

| Packaging Option | Packaging Specification | Quantity | Quantity & Packaging Code |
|-------------------|-----------------------------|----------|---------------------------|
| 8mm Tape and Reel | EIA-481-1 (IEC 286, part 3) | 3000 | WR |

Mouser Electronics

Authorized Distributor

Click to View Pricing, Inventory, Delivery & Lifecycle Information:

Littelfuse:

[0437004.WR](#) [0437002.WR](#) [043701.5WR](#) [04371.75WR](#) [043702.5WR](#) [0437.250WR](#) [043703.5WR](#) [0437003.WR](#)
[0437007.WR](#) [0437.375WR](#) [0437008.WR](#) [04371.25WR](#) [0437005.WR](#) [0437.500WR](#) [0437001.WR](#) [0437.750WR](#)