



# ESDAVLC8-1BM2, ESDAVLC8-1BT2

Single-line low capacitance Transil™, transient surge voltage suppressor (TVS) for ESD protection

Datasheet – production data

## Features

- Single-line bidirectional protection
- Breakdown voltage = 8.5 V min.
- Very low capacitance = 4.5 pF @ 0 V
- Lead-free packages
- ECOPACK®2 compliant packages

## Benefits

- Very low capacitance for optimized data integrity
- Very low reverse current < 50 nA
- Low PCB space consumption: 0.6 mm<sup>2</sup> max
- High reliability offered by monolithic integration

## Complies with the following standards:

- IEC 61000-4-2 level 4
  - 15 kV (air discharge)
  - 8 kV (contact discharge)
- MIL STD 883G - Method 3015-7: class 3
  - HBM (human body model)

## Applications

Where transient overvoltage protection in ESD sensitive equipment is required, such as:

- Computers
- Printers
- Communication systems
- Cellular phone handsets and accessories
- Video equipment

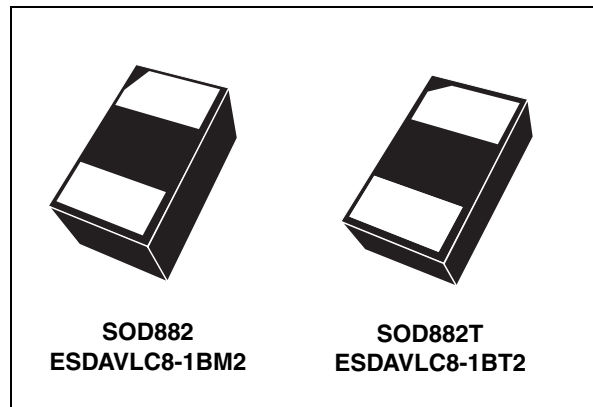
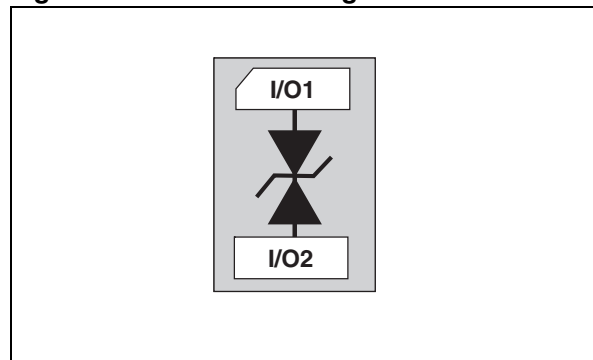

Figure 1. Functional diagram



## Description

The ESDAVLC8-1BM2 and ESDAVLC8-1BT2 are bidirectional single-line TVS diodes designed to protect data lines or other I/O ports against ESD transients.

The devices are ideal for applications where both printed circuit board space and power absorption capability are required.

TM: Transil is a trademark of STMicroelectronics

# 1 Characteristics

**Table 1. Absolute maximum ratings ( $T_{amb} = 25\text{ }^{\circ}\text{C}$ )**

Symbol	Parameter		Value	Unit
$V_{PP}^{(1)}$	Peak pulse voltage	IEC 61000-4-2 contact discharge	17	kV
		IEC 61000-4-2 air discharge	17	
		MIL STD 883G - Method 3015-7: class 3	25	
$P_{PP}^{(1)}$	Peak pulse power dissipation (8/20 $\mu\text{s}$ )	$T_j \text{ initial} = T_{amb}$	30	W
$I_{PP}$	Peak pulse current (8/20 $\mu\text{s}$ )		1.3	A
$T_{OP}$	Operating junction temperature range		- 55 to + 150	$^{\circ}\text{C}$
$T_{stg}$	Storage temperature range		- 65 to + 150	$^{\circ}\text{C}$
$T_L$	Maximum lead temperature for soldering during 10 s		260	$^{\circ}\text{C}$

1. For a surge greater than the maximum values, the diode will fail in short-circuit.

**Figure 2. Electrical characteristics (definitions)**

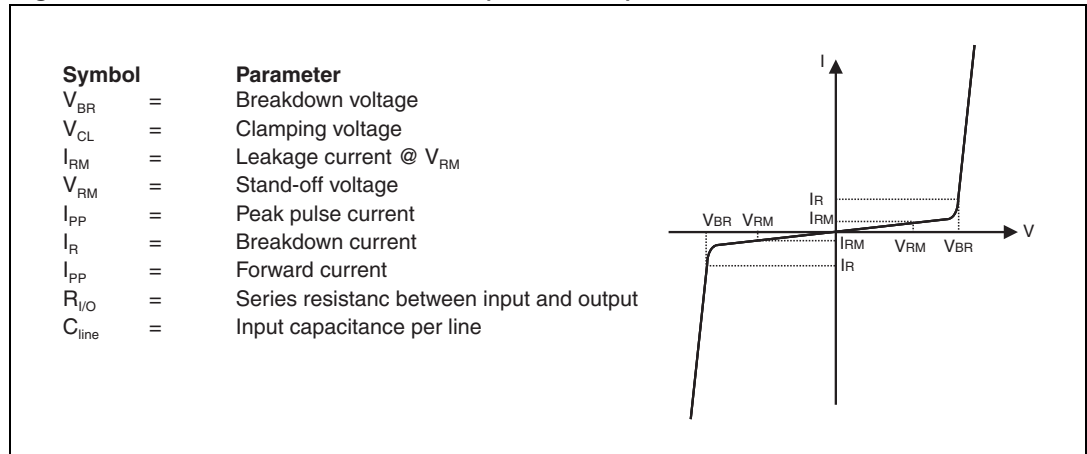

**Table 2. Electrical characteristics (values,  $T_{amb} = 25\text{ }^{\circ}\text{C}$ )**

Symbol	Test condition	Min.	Typ.	Max.	Unit
$V_{BR}$	From pin1 to pin2, $I_R = 1\text{ mA}$ direct	14.5	17		V
	From pin2 to pin1, $I_R = 1\text{ mA}$ reverse	8.5	11		
$I_{RM}$	$V_{RM} = 3\text{ V}$			50	nA
$R_d$	Square pulse, $I_{PP} = 1\text{ A}$ $t_p = 2.5\text{ }\mu\text{s}$		2		$\Omega$
$C_{line}$	$F = 1\text{ MHz}$ , $V_R = 0\text{ V}$		4.5	5.5	pF

**Figure 3. Relative variation of peak pulse power versus initial junction temperature**

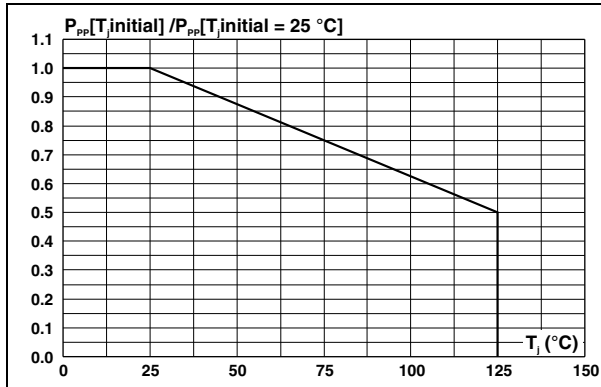

**Figure 4. Junction capacitance versus reverse voltage applied (typical values, direct and reverse)**

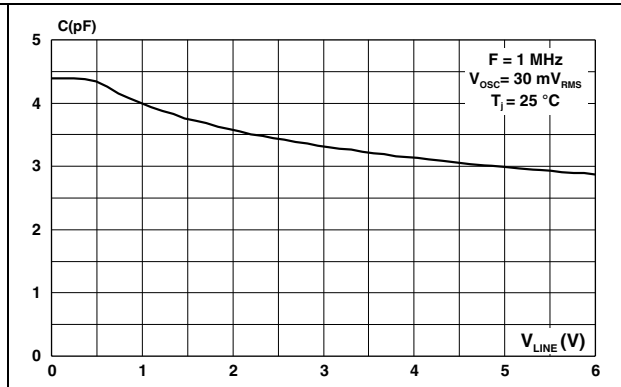

**Figure 5. Peak pulse power versus exponential pulse duration (direct)**

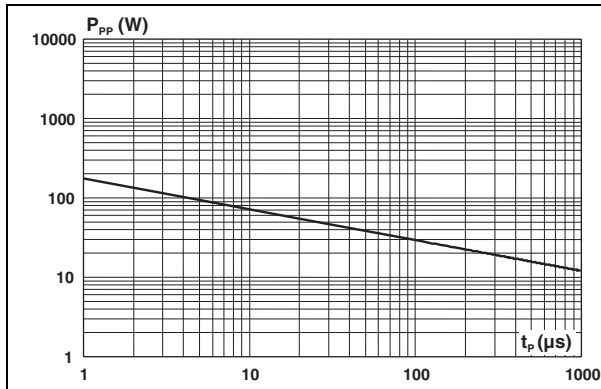

**Figure 6. Peak pulse power versus exponential pulse duration (reverse)**

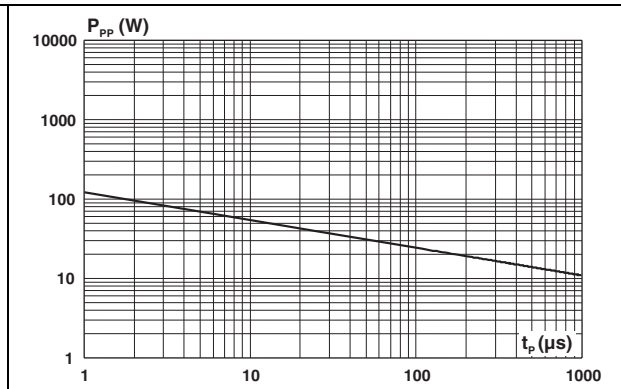

**Figure 7. Clamping voltage versus peak pulse current (typical values, exponential waveform, direct)**

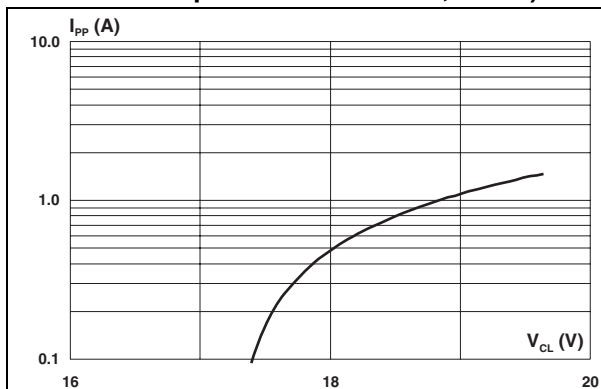

**Figure 8. Clamping voltage versus peak pulse current (typical values, exponential waveform, reverse)**

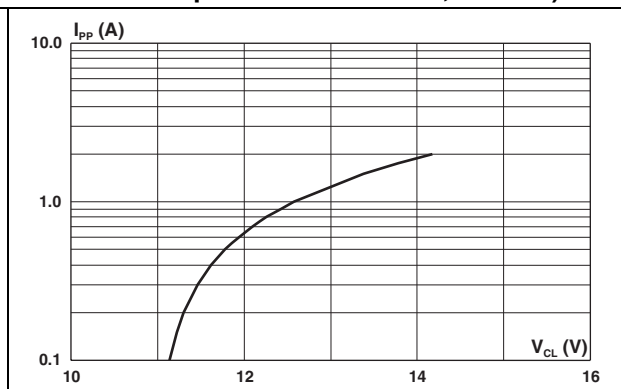

Figure 9. Relative variation of leakage current versus junction temperature (direct)

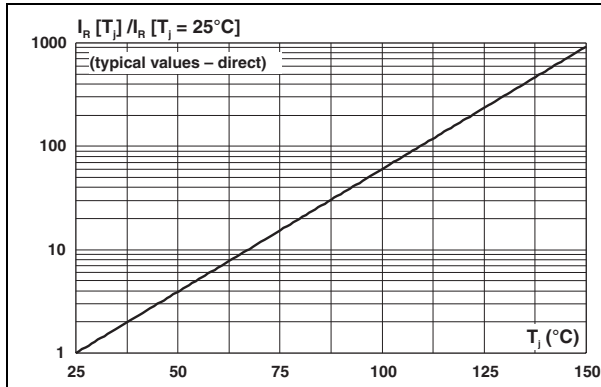

Figure 10. Relative variation of leakage current versus junction temperature (reverse)

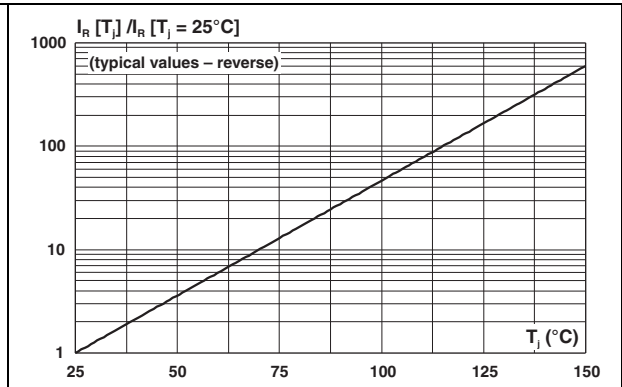

Figure 11. ESD response to IEC 61000-4-2 (+15kV air discharge)

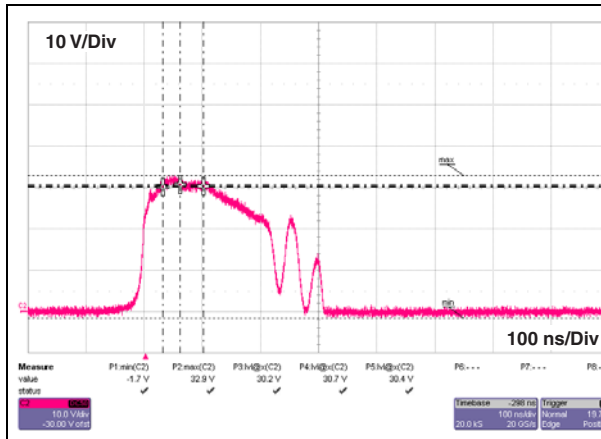

Figure 12. ESD response to IEC 61000-4-2 (-15kV air discharge)

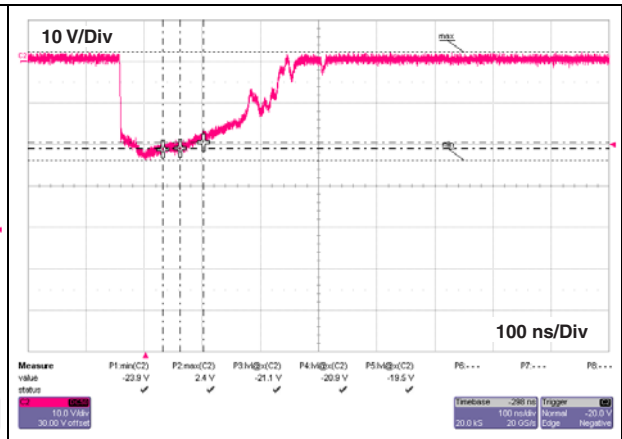

Figure 13. S21 attenuation measurement result

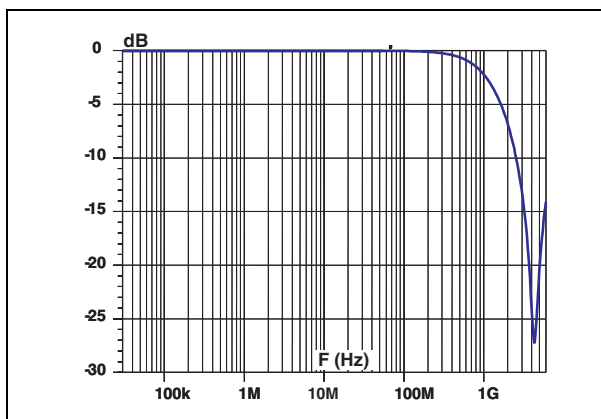
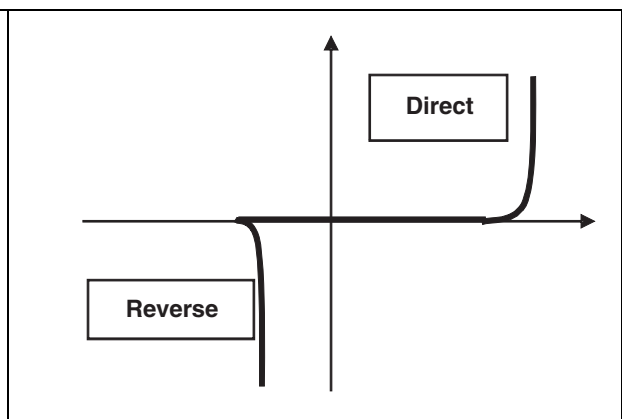
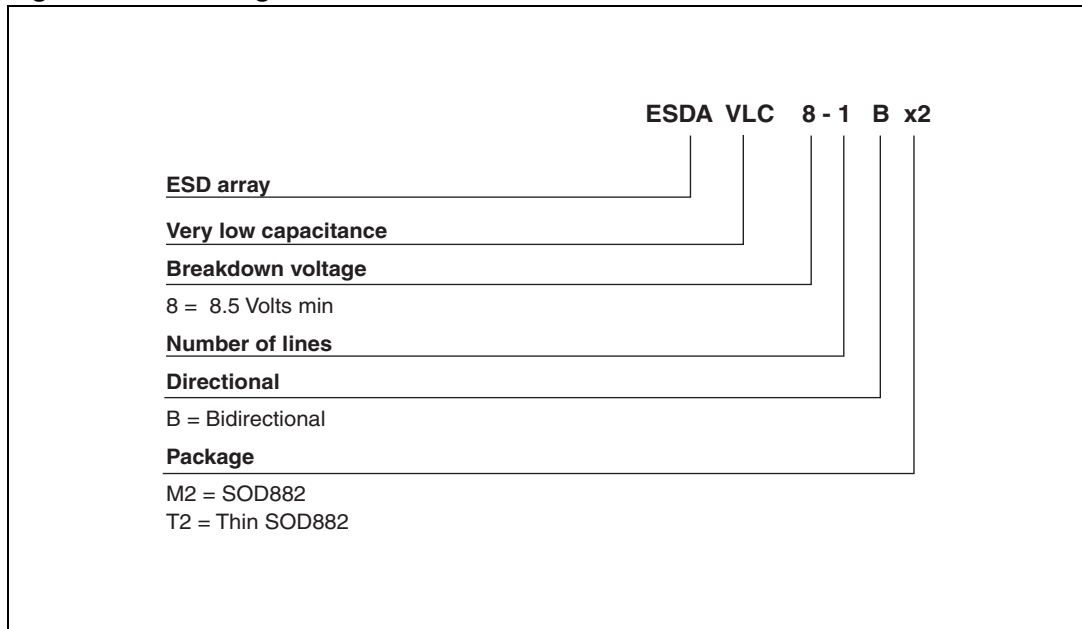

Figure 14. Static characteristic



## 2 Ordering information scheme

Figure 15. Ordering information scheme



### 3 Package information

- Epoxy meets UL94, V0
- Lead-free packages

In order to meet environmental requirements, ST offers these devices in different grades of ECOPACK® packages, depending on their level of environmental compliance. ECOPACK® specifications, grade definitions and product status are available at: [www.st.com](http://www.st.com). ECOPACK® is an ST trademark.

Figure 16. SOD882 dimension definitions

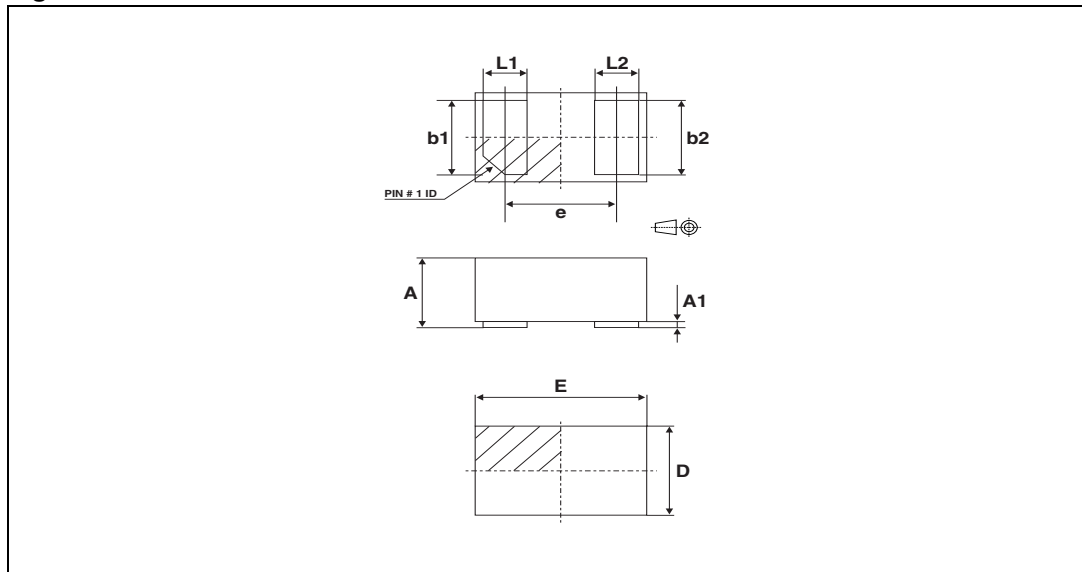
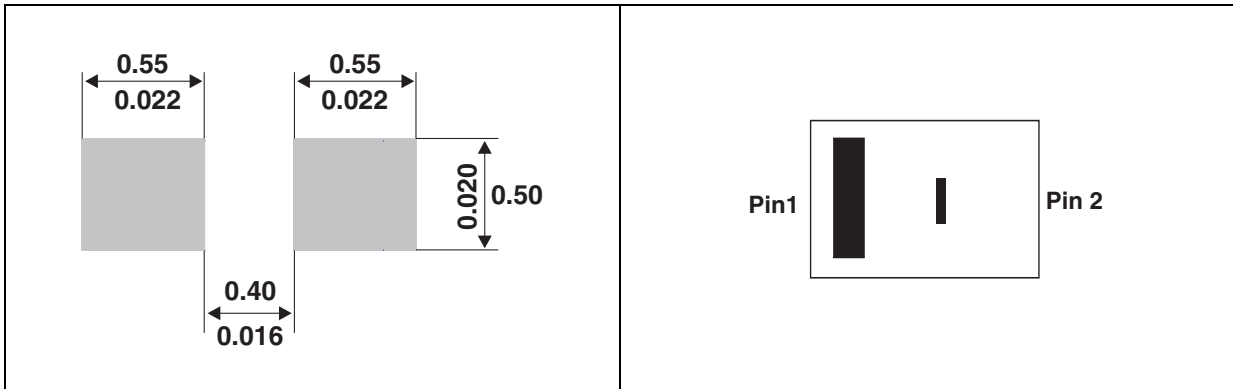

Table 3. SOD882 dimension values

Ref.	Dimensions					
	Millimeters			Inches		
	Min.	Typ.	Max.	Min.	Typ.	Max.
A	0.40	0.47	0.50	0.016	0.019	0.020
A1	0.00		0.05	0.000		0.002
b1	0.45	0.50	0.55	0.018	0.020	0.022
b2	0.45	0.50	0.55	0.018	0.020	0.022
D	0.55	0.60	0.65	0.022	0.024	0.026
E	0.95	1.00	1.05	0.037	0.039	0.041
e	0.60	0.65	0.70	0.024	0.026	0.028
L1	0.20	0.25	0.30	0.008	0.010	0.012
L2	0.20	0.25	0.30	0.008	0.010	0.012

Figure 17. SOD882 footprint in mm (inches)

Figure 18. SOD882 marking



Note: Product marking may be rotated by multiples of 90° for assembly plant differentiation. In no case should this product marking be used to orient the component for its placement on a PCB. Only pin 1 mark is to be used for this purpose.

Figure 19. SOD882 tape and reel specifications

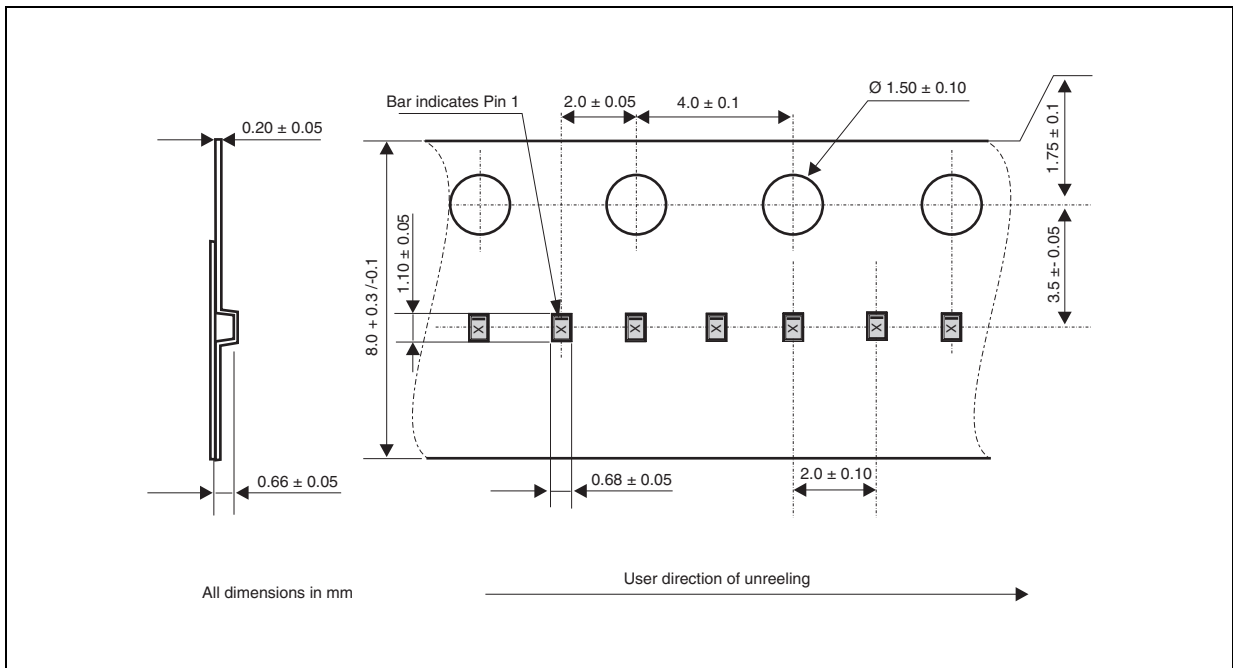

Figure 20. SOD882T dimension definitions

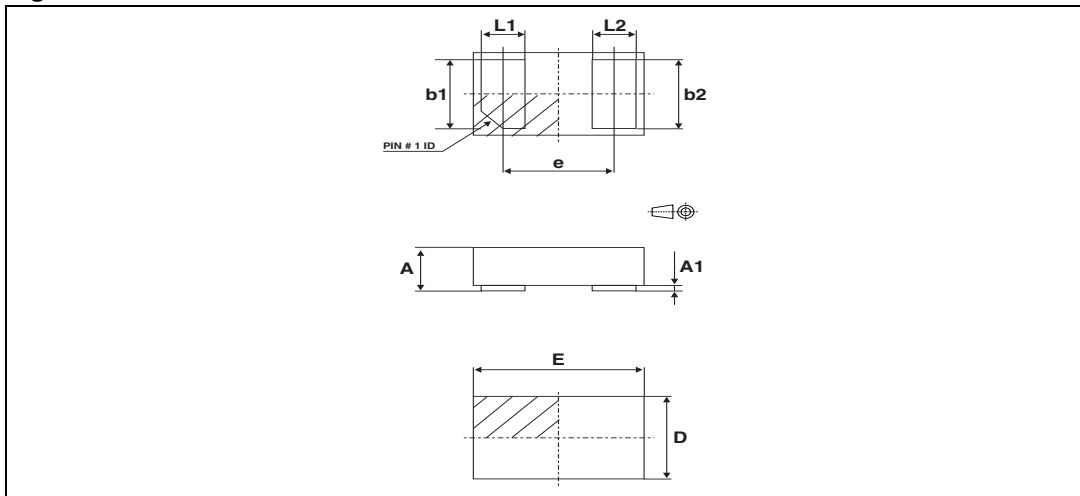
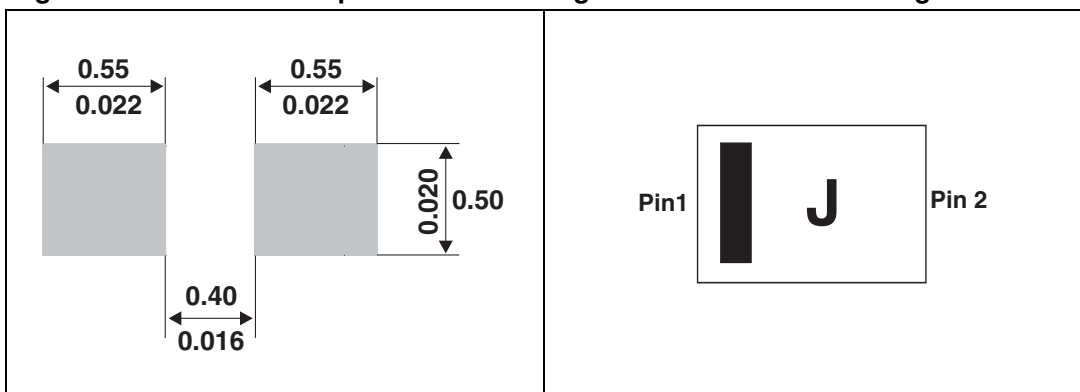

Table 4. SOD882T dimension values

Ref.	Dimensions					
	Millimeters			Inches		
	Min.	Typ.	Max.	Min.	Typ.	Max.
A	0.30		0.40	0.012		0.016
A1	0.00		0.05	0.000		0.002
b1	0.45	0.50	0.55	0.018	0.020	0.022
b2	0.45	0.50	0.55	0.018	0.020	0.022
D	0.55	0.60	0.65	0.022	0.024	0.026
E	0.95	1.00	1.05	0.037	0.039	0.041
e	0.60	0.65	0.70	0.024	0.026	0.028
L1	0.20	0.25	0.30	0.008	0.010	0.012
L2	0.20	0.25	0.30	0.008	0.010	0.012

Figure 21. SOD882T footprint

Figure 22. SOD882T marking



Note: Product marking may be rotated by multiples of 90° for assembly plant differentiation. In no case should this product marking be used to orient the component for its placement on a PCB. Only pin 1 mark is to be used for this purpose.



Figure 23. SOD882T tape and reel specifications

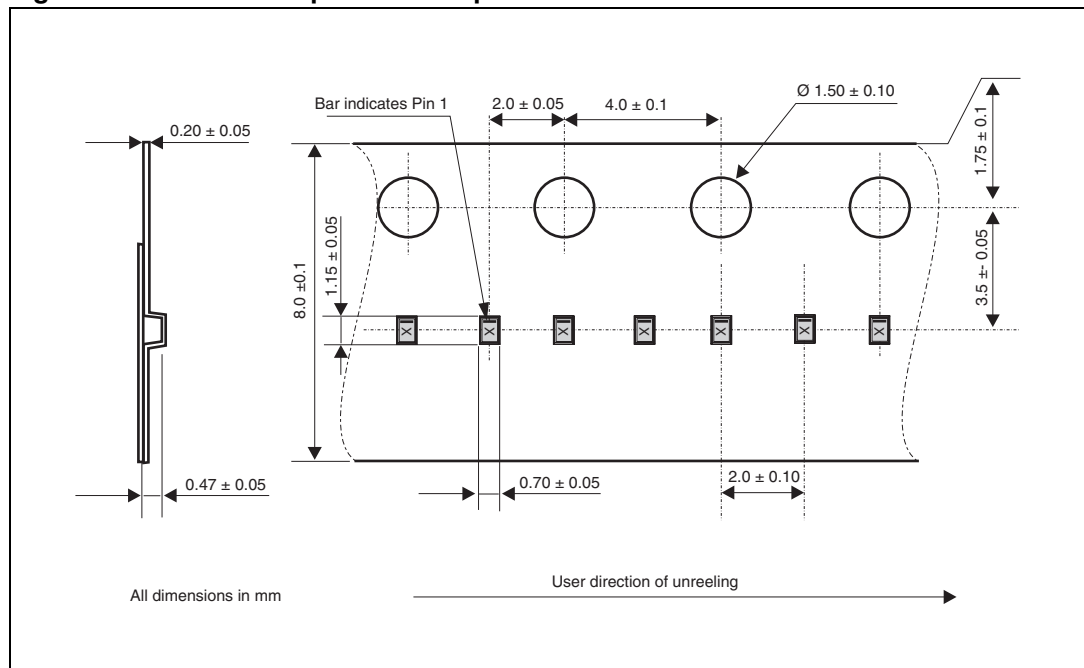

## 4 Recommendation on PCB assembly

### 4.1 Stencil opening design

1. General recommendation on stencil opening design
  - a) Stencil opening dimensions: L (Length), W (Width), T (Thickness).

**Figure 24. Stencil opening dimensions**

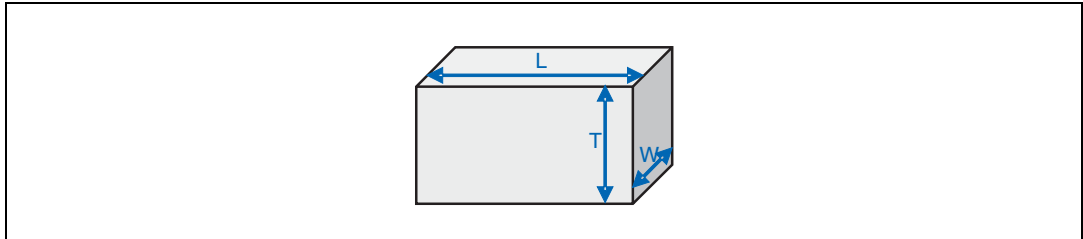

- b) General design rule
  - Stencil thickness (T) = 75 ~ 125 μm
  - Aspect Ratio =  $\frac{W}{T} \geq 1.5$
  - Aspect Area =  $\frac{L \times W}{2T(L + W)} \geq 0.66$

2. Reference design
  - a) Stencil opening thickness: 100 μm
  - b) Stencil opening for central exposed pad: Opening to footprint ratio is 50%.
  - c) Stencil opening for leads: Opening to footprint ratio is 90%.

**Figure 25. Recommended stencil window position**

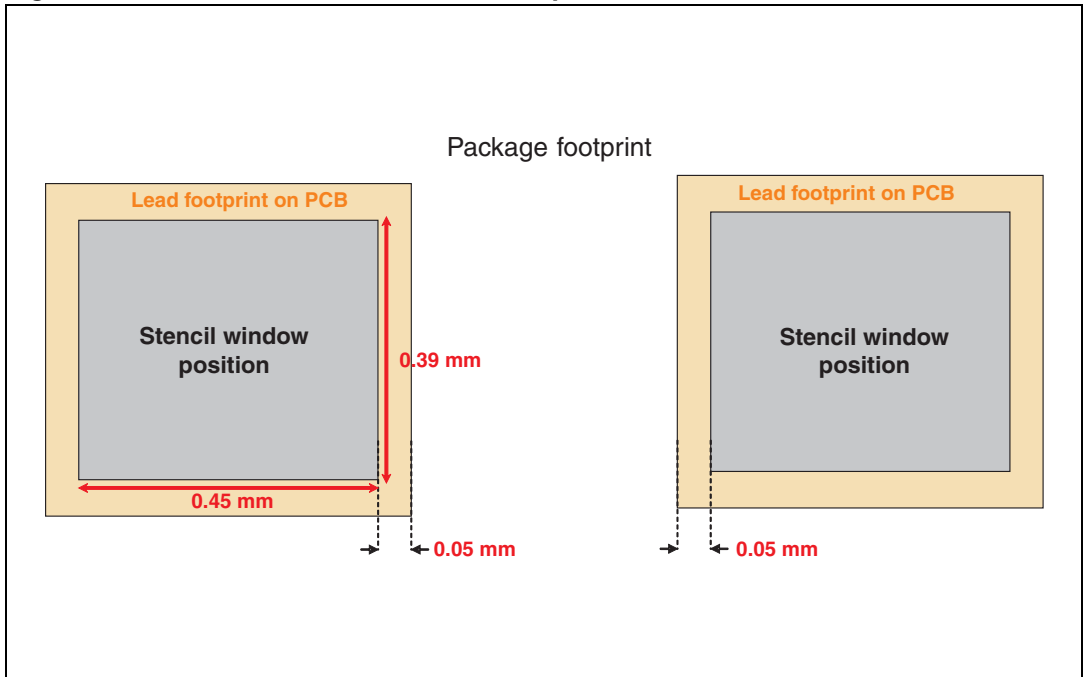

## 4.2 Solder paste

1. Halide-free flux qualification ROL0 according to ANSI/J-STD-004.
2. “No clean” solder paste is recommended.
3. Offers a high tack force to resist component movement during high speed.
4. Solder paste with fine particles: powder particle size is 20-45  $\mu\text{m}$ .

## 4.3 Placement

1. Manual positioning is not recommended.
2. It is recommended to use the lead recognition capabilities of the placement system, not the outline centering.
3. Standard tolerance of  $\pm 0.05$  mm is recommended.
4. 3.5 N placement force is recommended. Too much placement force can lead to squeezed out solder paste and cause solder joints to short. Too low placement force can lead to insufficient contact between package and solder paste that could cause open solder joints or badly centered packages.
5. To improve the package placement accuracy, a bottom side optical control should be performed with a high resolution tool.
6. For assembly, a perfect supporting of the PCB (all the more on flexible PCB) is recommended during solder paste printing, pick and place and reflow soldering by using optimized tools.

## 4.4 PCB design preference

1. To control the solder paste amount, the closed via is recommended instead of open vias.
2. The position of tracks and open vias in the solder area should be well balanced. The symmetrical layout is recommended, in case any tilt phenomena caused by asymmetrical solder paste amount due to the solder flow away.

### 4.5 Reflow profile

Figure 26. ST ECOPACK<sup>®</sup> recommended soldering reflow profile for PCB mounting

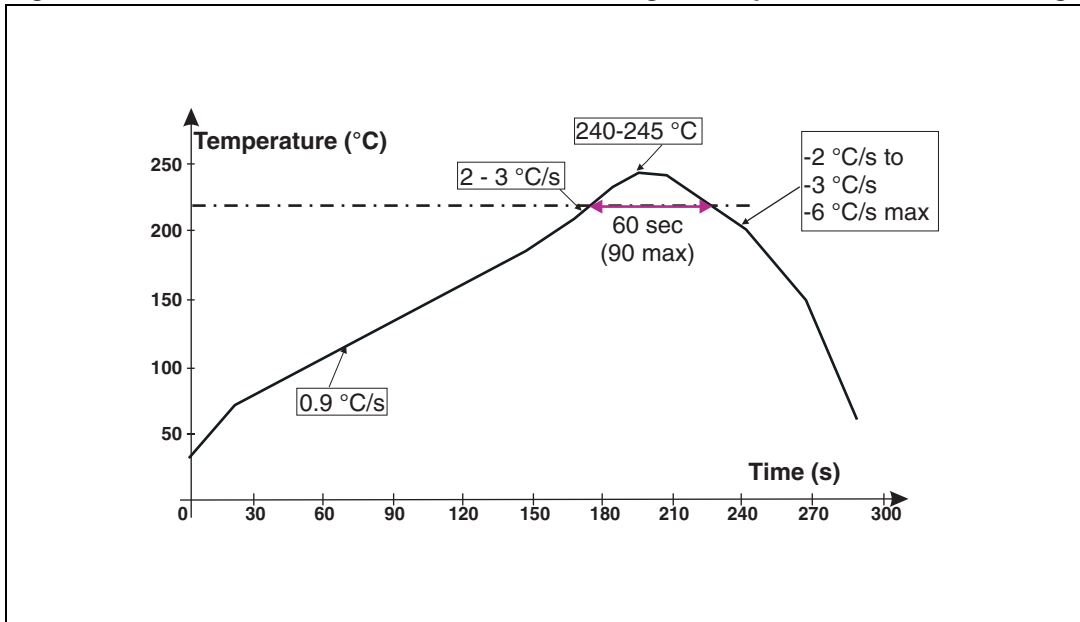

Note: Minimize air convection currents in the reflow oven to avoid component movement.

## 5 Ordering information

**Table 5. Ordering information**

Order code	Marking <sup>(1)</sup>	Package	Weight	Base qty	Delivery mode
ESDAVLC8-1BM2	I	SOD882	0.92 mg	12000	Tape and reel
ESDAVLC8-1BT2	J	SOD882T	0.76 mg	12000	Tape and reel

1. The marking can be rotated by multiples of 90° to differentiate assembly location

## 6 Revision history

**Table 6. Document revision history**

Date	Revision	Changes
22-Jan-2010	1	Initial release.
08-Jun-2012	2	Updated <a href="#">Figure 11</a> , <a href="#">Figure 12</a> , <a href="#">Figure 16</a> , <a href="#">Figure 19</a> , <a href="#">Figure 20</a> and added <a href="#">Figure 23</a> . Updated <a href="#">Table 3</a> , and <a href="#">Table 4</a> . Updated note on page 7, 8 and 13.

**Please Read Carefully:**

Information in this document is provided solely in connection with ST products. STMicroelectronics NV and its subsidiaries ("ST") reserve the right to make changes, corrections, modifications or improvements, to this document, and the products and services described herein at any time, without notice.

All ST products are sold pursuant to ST's terms and conditions of sale.

Purchasers are solely responsible for the choice, selection and use of the ST products and services described herein, and ST assumes no liability whatsoever relating to the choice, selection or use of the ST products and services described herein.

No license, express or implied, by estoppel or otherwise, to any intellectual property rights is granted under this document. If any part of this document refers to any third party products or services it shall not be deemed a license grant by ST for the use of such third party products or services, or any intellectual property contained therein or considered as a warranty covering the use in any manner whatsoever of such third party products or services or any intellectual property contained therein.

**UNLESS OTHERWISE SET FORTH IN ST'S TERMS AND CONDITIONS OF SALE ST DISCLAIMS ANY EXPRESS OR IMPLIED WARRANTY WITH RESPECT TO THE USE AND/OR SALE OF ST PRODUCTS INCLUDING WITHOUT LIMITATION IMPLIED WARRANTIES OF MERCHANTABILITY, FITNESS FOR A PARTICULAR PURPOSE (AND THEIR EQUIVALENTS UNDER THE LAWS OF ANY JURISDICTION), OR INFRINGEMENT OF ANY PATENT, COPYRIGHT OR OTHER INTELLECTUAL PROPERTY RIGHT.**

**UNLESS EXPRESSLY APPROVED IN WRITING BY TWO AUTHORIZED ST REPRESENTATIVES, ST PRODUCTS ARE NOT RECOMMENDED, AUTHORIZED OR WARRANTED FOR USE IN MILITARY, AIR CRAFT, SPACE, LIFE SAVING, OR LIFE SUSTAINING APPLICATIONS, NOR IN PRODUCTS OR SYSTEMS WHERE FAILURE OR MALFUNCTION MAY RESULT IN PERSONAL INJURY, DEATH, OR SEVERE PROPERTY OR ENVIRONMENTAL DAMAGE. ST PRODUCTS WHICH ARE NOT SPECIFIED AS "AUTOMOTIVE GRADE" MAY ONLY BE USED IN AUTOMOTIVE APPLICATIONS AT USER'S OWN RISK.**

Resale of ST products with provisions different from the statements and/or technical features set forth in this document shall immediately void any warranty granted by ST for the ST product or service described herein and shall not create or extend in any manner whatsoever, any liability of ST.

ST and the ST logo are trademarks or registered trademarks of ST in various countries.

Information in this document supersedes and replaces all information previously supplied.

The ST logo is a registered trademark of STMicroelectronics. All other names are the property of their respective owners.

© 2012 STMicroelectronics - All rights reserved

STMicroelectronics group of companies

Australia - Belgium - Brazil - Canada - China - Czech Republic - Finland - France - Germany - Hong Kong - India - Israel - Italy - Japan - Malaysia - Malta - Morocco - Philippines - Singapore - Spain - Sweden - Switzerland - United Kingdom - United States of America

[www.st.com](http://www.st.com)

# Mouser Electronics

Authorized Distributor

Click to View Pricing, Inventory, Delivery & Lifecycle Information:

[STMicroelectronics:](#)

[ESDAVLC8-1BT2](#)