

1V5KE6V8(C)A - 1V5KE440(C)A 1500 W Transient Voltage Suppressors

Features

- Glass-Passivated Junction
- 1500 W Peak Pulse Power Capability at 1.0 ms
- Excellent Clamping Capability
- Low Incremental Surge Resistance
- Fast Response Time; Typically
 < 1.0 ps from 0 V to BV for Uni-directional,
 5.0 ns for Bidirectional
- Typical I_R : $1.0 \mu\text{A}$ Above 10 V
- UL Certified: UL #E210467

Applications

- Bi-directional Types Use CA Suffix
- Electrical Characteristics apply in both directions



DO-201AE
COLOR BAND DENOTES CATHODE
ON UNIDIRECTIONAL DEVICES ONLY. NO

Absolute Maximum Ratings

Stresses exceeding the absolute maximum ratings may damage the device. The device may not function or be operable above the recommended operating conditions and stressing the parts to these levels is not recommended. In addition, extended exposure to stresses above the recommended operating conditions may affect device reliability. The absolute maximum ratings are stress ratings only. Values are at $T_A = 25^\circ\text{C}$ unless otherwise noted.

Symbol	Parameter	Value	Units
P_{PPM}	Peak Pulse Power Dissipation $t_p = 1$ ms	1500	W
I_{PPM}	Peak Pulse Current	see table	A
I_{FSM}	Non-Repetitive Peak Forward Surge Current Superimposed on Rated Load (JEDEC Method) ⁽¹⁾	200	A
T_{stg}	Storage Temperature Range	-55 to +175	$^\circ\text{C}$
T_J	Operating Junction Temperature	-55 to +175	$^\circ\text{C}$

Note:

1. Measured on 8.3 ms single half-sine wave; duty cycle = 4 pulses per minute maximum.

Thermal Characteristics

Symbol	Parameter	Value	Units
P_D	Power Dissipation .375 inch lead length at $T_A = 75^\circ\text{C}$	5.0	W

Electrical CharacteristicsT_A = 25°C unless otherwise noted.

Uni-directional Bi-directional (C) Device	Reverse Stand-Off Voltage V _{RWM} (V)	Breakdown Voltage V _{BR} (V)		Test Current I _T (mA)	Clamping Voltage at I _{PPM} V _C (C)	Peak Pulse Current I _{PPM} (A)	Reverse Leakage V _{RWM} I _R (μA) ⁽²⁾
		Min.	Max.				
1V5KE6V8(C)A	5.80	6.45	7.14	10	10.5	143	1000
1V5KE7V5(C)A	6.40	7.13	7.88	10	11.3	133	500
1V5KE8V2(C)A	7.02	7.79	8.61	10	12.1	124	200
1V5KE9V1(C)A	7.78	8.65	9.55	1	13.4	112	50
1V5KE10(C)A	8.55	9.50	10.5	1	14.5	103	10
1V5KE11(C)A	9.40	10.5	11.6	1	15.6	96.2	5
1V5KE12(C)A	10.2	11.4	12.6	1	16.7	90.0	5
1V5KE13(C)A	11.1	12.4	13.7	1	18.2	82.0	5
1V5KE15(C)A	12.8	14.3	15.8	1	21.2	71.0	5
1V5KE16(C)A	13.6	15.2	16.8	1	22.5	67.0	5
1V5KE18(C)A	15.3	17.1	18.9	1	26.2	59.5	5
1V5KE20(C)A	17.1	19.0	21.0	1	27.7	54.2	5
1V5KE22(C)A	18.8	20.9	23.1	1	30.6	49.0	5
1V5KE24(C)A	20.5	22.8	25.2	1	33.2	45.2	5
1V5KE27(C)A	23.1	25.7	28.4	1	37.5	40.0	5
1V5KE30(C)A	25.6	28.5	31.5	1	41.4	36.2	5
1V5KE33(C)A	28.2	31.4	34.7	1	45.7	33.0	5
1V5KE36(C)A	30.8	34.2	37.8	1	49.9	30.1	5
1V5KE39(C)A	33.3	37.1	41.0	1	53.9	28.0	5
1V5KE43(C)A	36.8	40.9	45.2	1	59.3	25.3	5
1V5KE47(C)A	40.2	44.7	49.4	1	64.8	23.2	5
1V5KE51(C)A	43.6	48.5	53.6	1	70.1	21.4	5
1V5KE56(C)A	47.8	53.2	58.8	1	77.0	19.5	5
1VKE62(C)A	53.0	58.9	65.1	1	85.0	17.7	5
1V5KE68(C)A	58.1	64.6	71.4	1	92.0	16.3	5
1V5KE75(C)A	64.1	71.3	78.8	1	104.0	14.6	5
1V5KE82(C)A	70.1	77.9	86.1	1	113.0	13.3	5
1V5KE91(C)A	77.8	86.5	95.5	1	125.0	12.0	5
1V5KE100(C)A	85.5	95.0	105.0	1	137.0	11.0	5
1V5KE110(C)A	94.0	106.0	116.0	1	152.0	9.9	5
1V5KE120(C)A	102.0	114.0	126.0	1	165.0	9.1	5
1V5KE130(C)A	111.0	124.0	137.0	1	179.0	8.4	5
1V5KE150(C)A	128.0	143.0	158.0	1	207.0	7.2	5
1V5KE160(C)A	136.0	152.0	168.0	1	219.0	6.8	5

Electrical Characteristics (continuous) $T_A = 25^\circ\text{C}$ unless otherwise noted.

Uni-directional Bi-directional (C) Device	Reverse Stand-Off Voltage $V_{RWM}(V)$	Breakdown Voltage $V_{BR}(V)$		Test Current $I_T(mA)$	Clamping Voltage at $I_{PPM} V_C(C)$	Peak Pulse Current $I_{PPM} (A)$	Reverse Leakage V_{RWM} $I_R(\mu A)^{(2)}$
		Min.	Max.				
1V5KE170(C)A	145.0	162.0	179.0	1	234.0	6.4	5
1V5KE180(C)A	154.0	171.0	189.0	1	246.0	6.1	5
1V5KE200(C)A	171.0	190.0	210.0	1	274.0	5.5	5
1V5KE220(C)A	185.0	209.0	231.0	1	328.0	4.6	5
1V5KE250(C)A	214.0	237.0	263.0	1	344.0	4.5	5
1V5KE300(C)A	256.0	285.0	315.0	1	414.0	3.8	5
1V5KE350(C)A	300.0	333.0	368.0	1	482.0	3.2	5
1V5KE400(C)A	342.0	380.0	420.0	1	548.0	2.8	5
1V5KE440(C)A	376.0	418.0	462.0	1	602.0	2.6	5

Note:2. For bi-directional parts with $V_{RWM} < 10 V$, the I_R maximum limit is doubled.

Typical Performance Characteristics

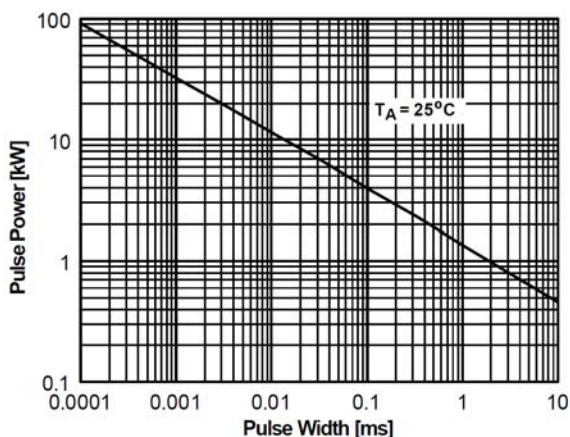

Figure 1. Peak Pulse Power Rating Curve

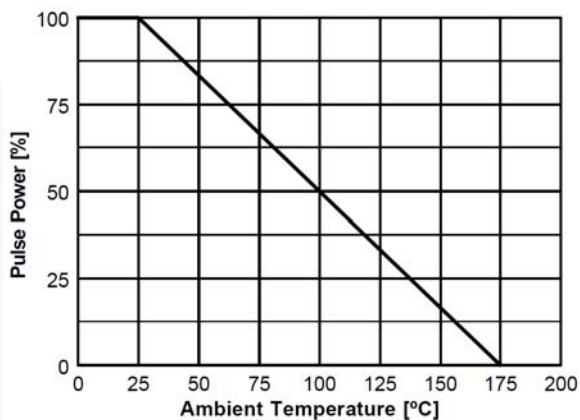

Figure 2. Pulse Derating Curve

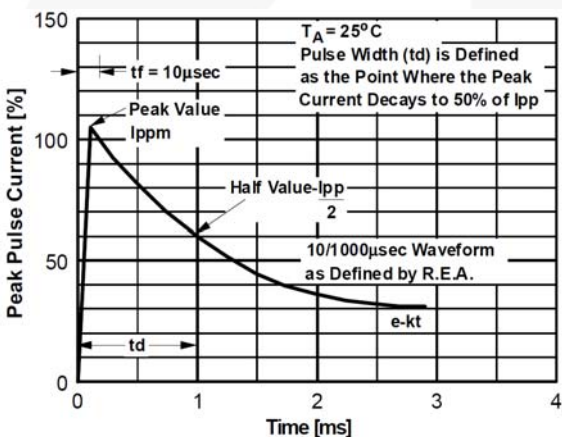

Figure 3. Pulse Waveform

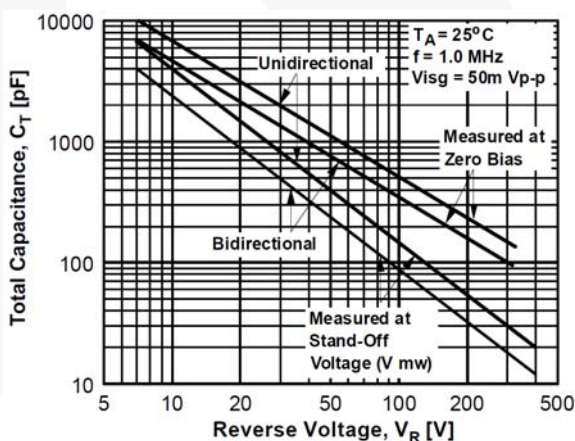

Figure 4. Total Capacitance

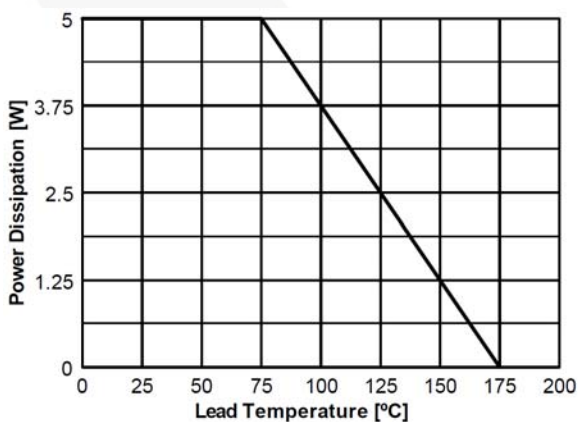

Figure 5. Steady State Power Derating Curve

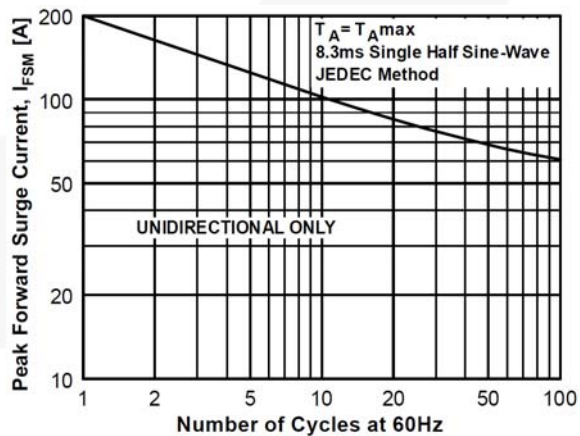
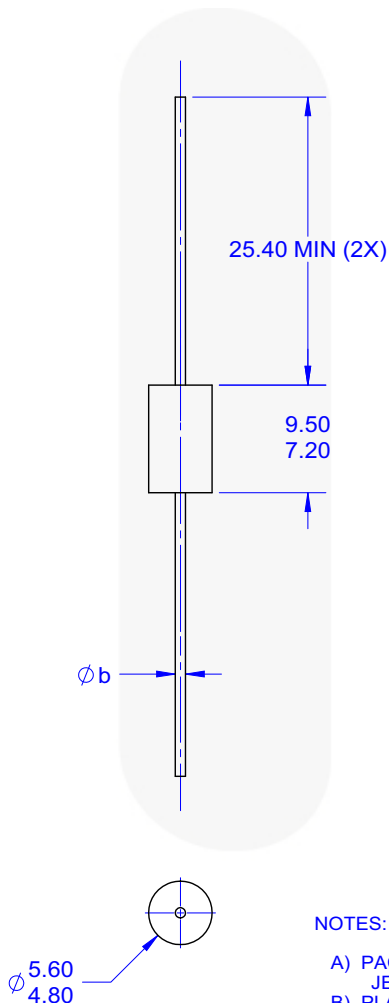

Figure 6. Non-Repetitive Surge Current

Physical Dimension

DO-201AE



NOTES: UNLESS OTHERWISE SPECIFIED

- A) PACKAGE STANDARD REFERENCE: JEDEC DO-201 VARIATION AD.
- B) PLASTIC PACKAGE BODY.
- D) ALL DIMENSIONS ARE IN MILLIMETERS.
- E) ϕb DIMENSION REPRESENT LIKE BELOW:
 OPTION AD = 1.20MIN TO 1.30MAX
 OPTION AE = 0.94MIN TO 1.07MAX
- E) DRAWING FILE NAME: DO201AREV1

Figure 7. AXIAL LEADED; JEDEC DO201; OPTION AD (ACTIVE)

Package drawings are provided as a service to customers considering Fairchild components. Drawings may change in any manner without notice. Please note the revision and/or date on the drawing and contact a Fairchild Semiconductor representative to verify or obtain the most recent revision. Package specifications do not expand the terms of Fairchild's worldwide terms and conditions, specifically the warranty therein, which covers Fairchild products.





Always visit Fairchild Semiconductor's online packaging area for the most recent package drawings:

<http://www.fairchildsemi.com/dwg/DO/DO201A.pdf>



TRADEMARKS

The following includes registered and unregistered trademarks and service marks, owned by Fairchild Semiconductor and/or its global subsidiaries, and is not intended to be an exhaustive list of all such trademarks.

AccuPower™	F-PFS™		Sync-Lock™
AX-CAP®*	FRFET®	PowerXS™	
BitSiC™	Global Power Resource SM	Programmable Active Droop™	TinyBoost®
Build it Now™	GreenBridge™	QFET®	TinyBuck®
CorePLUS™	Green FPS™	QS™	TinyCalc™
CorePOWER™	Green FPS™ e-Series™	Quiet Series™	TinyLogic®
CROSSVOLT™	Gmax™	RapidConfigure™	TINYOPTO™
CTL™	GTO™		TinyPower™
Current Transfer Logic™	IntelliMAX™	Saving our world, 1mW/W/kW at a time™	TinyPWM™
DEUXPEED®	ISOPLANAR™	SignalWise™	TinyWire™
Dual Cool™	Making Small Speakers Sound Louder and Better™	SmartMax™	TranSiC™
EcoSPARK®	MegaBuck™	SMART START™	TriFault Detect™
EfficientMax™	MICROCOUPLER™	Solutions for Your Success™	TRUECURRENT®*
ESBC™	MicroFET™	SPM®	μSerDes™
	MicroPak™	STEALTH™	
Fairchild®	MicroPak2™	SuperFET®	UHC®
Fairchild Semiconductor®	MillerDrive™	SuperSOT™-3	Ultra FRFET™
FACT Quiet Series™	MotionMax™	SuperSOT™-6	UniFET™
FACT®	mWSaver®	SuperSOT™-8	VcX™
FAST®	OptoHiT™	SupreMOS®	VisualMax™
FastvCore™	OPTOLOGIC®	SyncFET™	VoltagePlus™
FETBench™	OPTOPLANAR®		XS™
FPS™			

* Trademarks of System General Corporation, used under license by Fairchild Semiconductor.

DISCLAIMER

FAIRCHILD SEMICONDUCTOR RESERVES THE RIGHT TO MAKE CHANGES WITHOUT FURTHER NOTICE TO ANY PRODUCTS HEREIN TO IMPROVE RELIABILITY, FUNCTION, OR DESIGN. FAIRCHILD DOES NOT ASSUME ANY LIABILITY ARISING OUT OF THE APPLICATION OR USE OF ANY PRODUCT OR CIRCUIT DESCRIBED HEREIN; NEITHER DOES IT CONVEY ANY LICENSE UNDER ITS PATENT RIGHTS, NOR THE RIGHTS OF OTHERS. THESE SPECIFICATIONS DO NOT EXPAND THE TERMS OF FAIRCHILD'S WORLDWIDE TERMS AND CONDITIONS, SPECIFICALLY THE WARRANTY THEREIN, WHICH COVERS THESE PRODUCTS.

LIFE SUPPORT POLICY

FAIRCHILD'S PRODUCTS ARE NOT AUTHORIZED FOR USE AS CRITICAL COMPONENTS IN LIFE SUPPORT DEVICES OR SYSTEMS WITHOUT THE EXPRESS WRITTEN APPROVAL OF FAIRCHILD SEMICONDUCTOR CORPORATION.

As used herein:

1. Life support devices or systems are devices or systems which, (a) are intended for surgical implant into the body or (b) support or sustain life, and (c) whose failure to perform when properly used in accordance with instructions for use provided in the labeling, can be reasonably expected to result in a significant injury of the user.
2. A critical component in any component of a life support, device, or system whose failure to perform can be reasonably expected to cause the failure of the life support device or system, or to affect its safety or effectiveness.

ANTI-COUNTERFEITING POLICY

Fairchild Semiconductor Corporation's Anti-Counterfeiting Policy. Fairchild's Anti-Counterfeiting Policy is also stated on our external website, www.fairchildsemi.com, under Sales Support.

Counterfeiting of semiconductor parts is a growing problem in the industry. All manufacturers of semiconductor products are experiencing counterfeiting of their parts. Customers who inadvertently purchase counterfeit parts experience many problems such as loss of brand reputation, substandard performance, failed applications, and increased cost of production and manufacturing delays. Fairchild is taking strong measures to protect ourselves and our customers from the proliferation of counterfeit parts. Fairchild strongly encourages customers to purchase Fairchild parts either directly from Fairchild or from Authorized Fairchild Distributors who are listed by country on our web page cited above. Products customers buy either from Fairchild directly or from Authorized Fairchild Distributors are genuine parts, have full traceability, meet Fairchild's quality standards for handling and storage and provide access to Fairchild's full range of up-to-date technical and product information. Fairchild and our Authorized Distributors will stand behind all warranties and will appropriately address any warranty issues that may arise. Fairchild will not provide any warranty coverage or other assistance for parts bought from Unauthorized Sources. Fairchild is committed to combat this global problem and encourage our customers to do their part in stopping this practice by buying direct or from authorized distributors.

PRODUCT STATUS DEFINITIONS

Definition of Terms

Datasheet Identification	Product Status	Definition
Advance Information	Formative / In Design	Datasheet contains the design specifications for product development. Specifications may change in any manner without notice.
Preliminary	First Production	Datasheet contains preliminary data; supplementary data will be published at a later date. Fairchild Semiconductor reserves the right to make changes at any time without notice to improve design.
No Identification Needed	Full Production	Datasheet contains final specifications. Fairchild Semiconductor reserves the right to make changes at any time without notice to improve the design.
Obsolete	Not In Production	Datasheet contains specifications on a product that is discontinued by Fairchild Semiconductor. The datasheet is for reference information only.

Rev. I66

Mouser Electronics

Authorized Distributor

Click to View Pricing, Inventory, Delivery & Lifecycle Information:

[Fairchild Semiconductor:](#)

[1V5KE91A](#)