

DATA SHEET

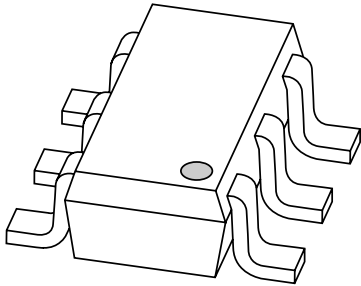

BZA418A

Quadruple ESD transient voltage
suppressor

Quadruple ESD transient voltage suppressor

BZA418A

FEATURES

- ESD rating >8 kV, according to IEC1000-4-2
- SOT457 surface mount package
- Common anode configuration
- Non-clamping range -0.5 to 18 V
- Maximum reverse peak power dissipation: 19.6 W at $t_p = 1$ ms
- Maximum clamping voltage at peak pulse current: 27 V at $I_{ZSM} = 0.7$ A.

APPLICATIONS

- Computers and peripherals
- Audio and video equipment
- Communication systems
- Medical equipment.

DESCRIPTION

Monolithic transient voltage suppressor diode in a six lead SOT457 (SC-74) package for 4-bit wide ESD transient suppression at 18 V level.

PINNING

PIN	DESCRIPTION
1	cathode 1
2	common
3	cathode 2
4	cathode 3
5	common
6	cathode 4

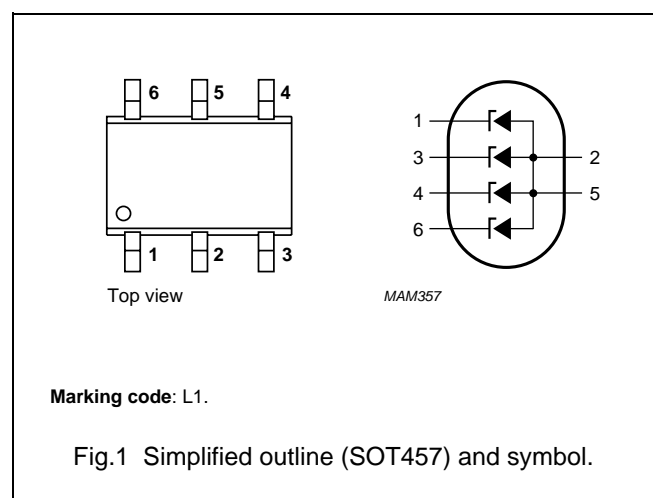

LIMITING VALUES

In accordance with the Absolute Maximum Rating System (IEC 60134).

SYMBOL	PARAMETER	CONDITIONS	MIN.	MAX.	UNIT
Per diode					
I_Z	working current	$T_s = 60$ °C; note 1	-	note 2	mA
I_F	continuous forward current	$T_s = 60$ °C	-	100	mA
I_{FSM}	non-repetitive peak forward current	$t_p = 1$ ms; square pulse	-	3.75	A
I_{ZSM}	non-repetitive peak reverse current	$t_p = 1$ ms; square pulse; see Fig.2	-	0.7	A
P_{tot}	total power dissipation	$T_s = 60$ °C; see Fig.3	-	720	mW
P_{ZSM}	non repetitive peak reverse power dissipation	square pulse; $t_p = 1$ ms; see Fig.4	-	19.6	W
T_{stg}	storage temperature		-65	+150	°C
T_j	junction temperature		-65	+150	°C

Notes

1. T_s is the temperature at the soldering point of the anode pin.
2. DC working current limited by $P_{tot\ max}$.

Quadruple ESD transient voltage suppressor

BZA418A

THERMAL CHARACTERISTICS

SYMBOL	PARAMETER	CONDITIONS	VALUE	UNIT
$R_{th\ j-s}$	thermal resistance from junction to soldering point	one or more diodes loaded	125	K/W

ELECTRICAL CHARACTERISTICS

$T_j = 25\text{ °C}$ unless otherwise specified.

SYMBOL	PARAMETER	CONDITIONS	MIN.	TYP.	MAX.	UNIT
Per diode						
V_Z	working voltage	$I_Z = 1\text{ mA}$	17.1	18	18.9	V
V_F	forward voltage	$I_F = 200\text{ mA}$	–	–	1.3	V
V_{ZSM}	non-repetitive peak reverse voltage	$I_{ZSM} = 0.7\text{ A}; t_p = 1\text{ ms}$	–	–	27	V
I_R	reverse current	$V_R = 14\text{ V}$	–	–	75	nA
r_{dif}	differential resistance	$I_Z = 1\text{ mA}$	–	–	125	Ω
S_Z	temperature coefficient of working voltage	$I_Z = 5\text{ mA}$	–	14.4	–	mV/K
C_d	diode capacitance	see Fig.5 $V_R = 0; f = 1\text{ MHz}$ $V_R = 13\text{ V}; f = 1\text{ MHz}$	– –	– –	48 14	pF pF

Quadruple ESD transient voltage suppressor

BZA418A

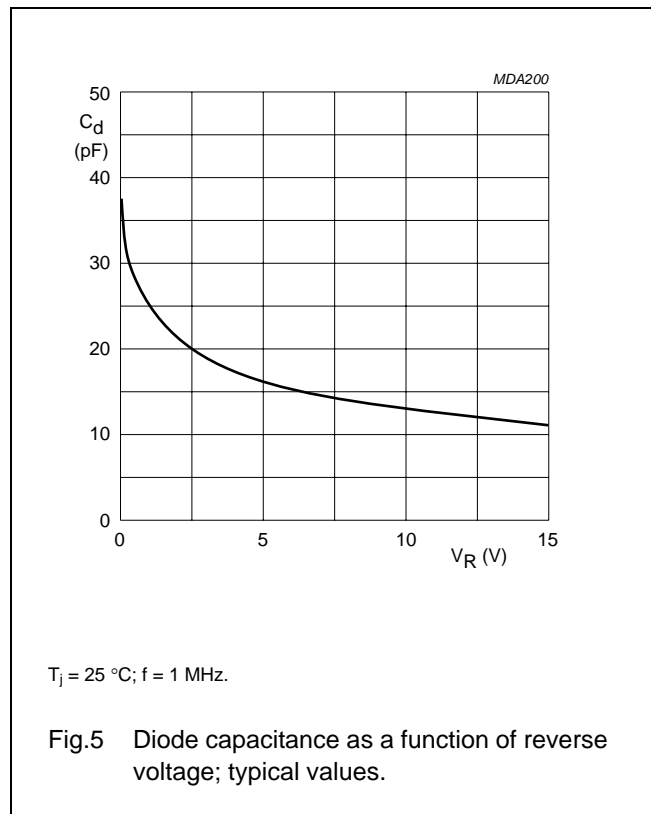
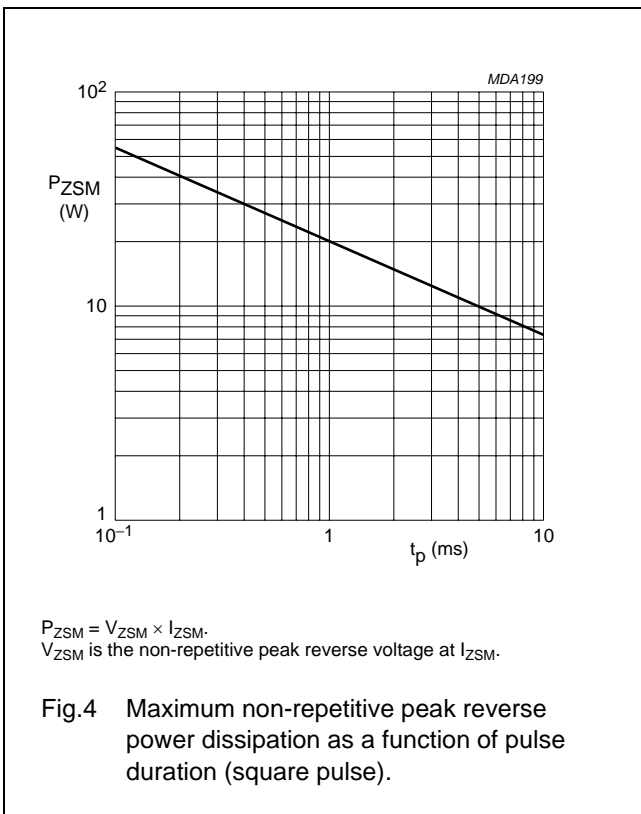
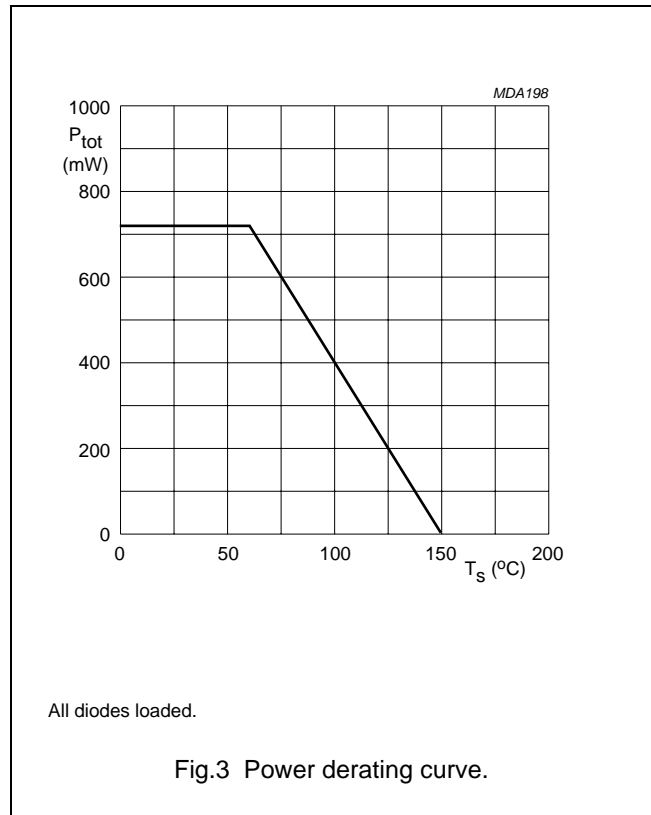
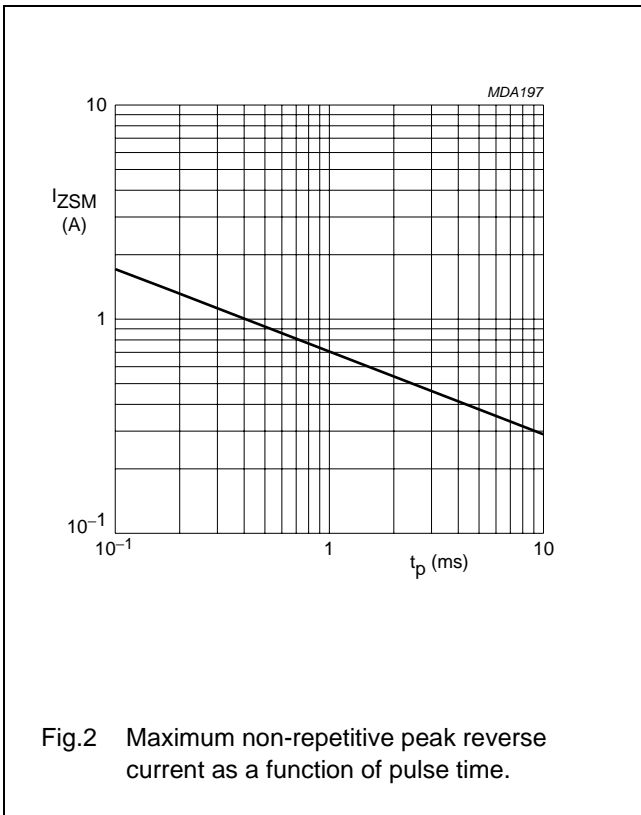

Quadruple ESD transient voltage suppressor

BZA418A

APPLICATION INFORMATION

Typical common anode application

A quadruple transient suppressor in a SOT457 package makes it possible to protect four separate lines using only one package. Two simplified examples are shown in Figs 6 and 7.

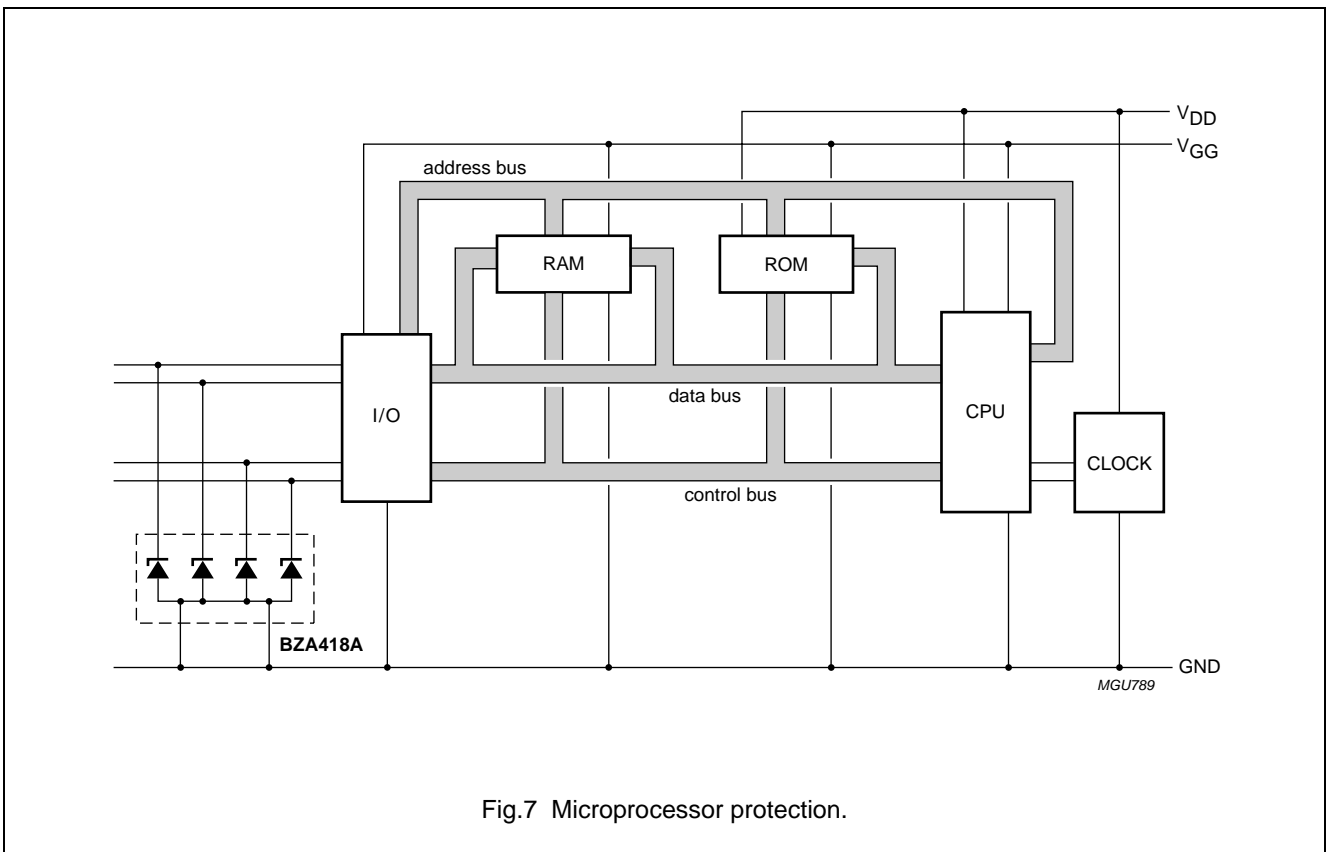
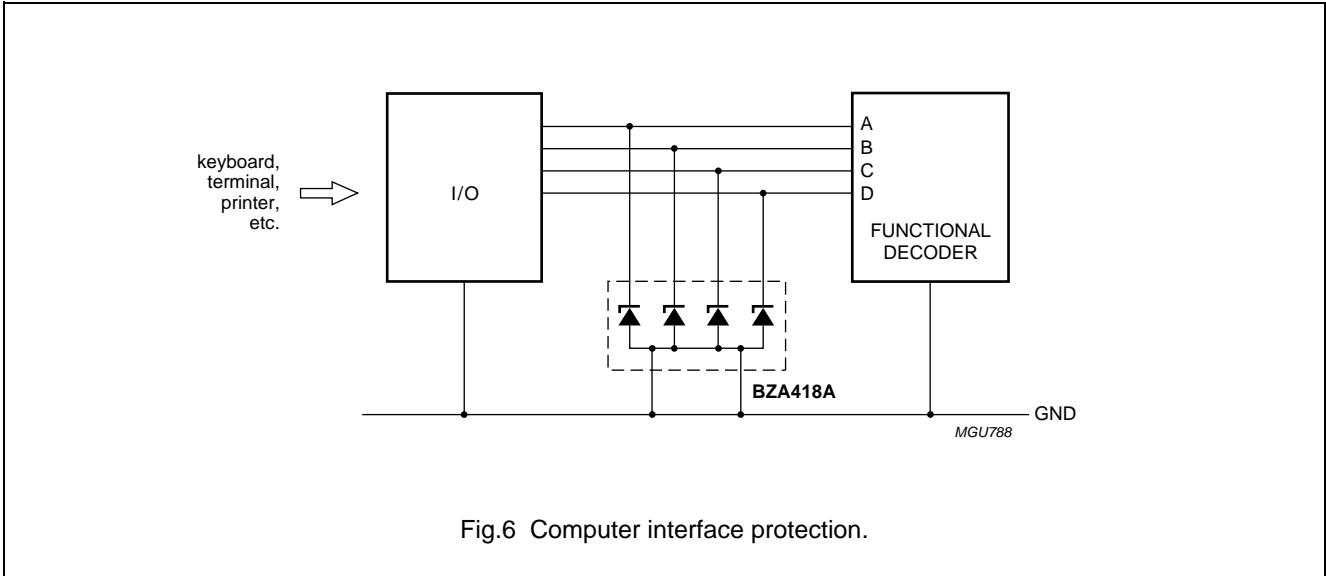

Quadruple ESD transient voltage suppressor

BZA418A

Device placement and printed-circuit board layout

Circuit board layout is of extreme importance in the suppression of transients. The clamping voltage of the BZA418A is determined by the peak transient current and the rate of rise of that current (di/dt). Since parasitic inductances can further add to the clamping voltage ($V = L di/dt$) the series conductor lengths on the printed-circuit board should be kept to a minimum. This includes the lead length of the suppression element.

In addition to minimizing conductor length the following printed-circuit board layout guidelines are recommended:

1. Place the suppression element close to the input terminals or connectors
2. Keep parallel signal paths to a minimum
3. Avoid running protection conductors in parallel with unprotected conductors
4. Minimize all printed-circuit board loop areas including power and ground loops
5. Minimize the length of the transient return path to ground
6. Avoid using shared transient return paths to a common ground point.

Quadruple ESD transient voltage suppressor

BZA418A

PACKAGE OUTLINE

Plastic surface mounted package; 6 leads

SOT457

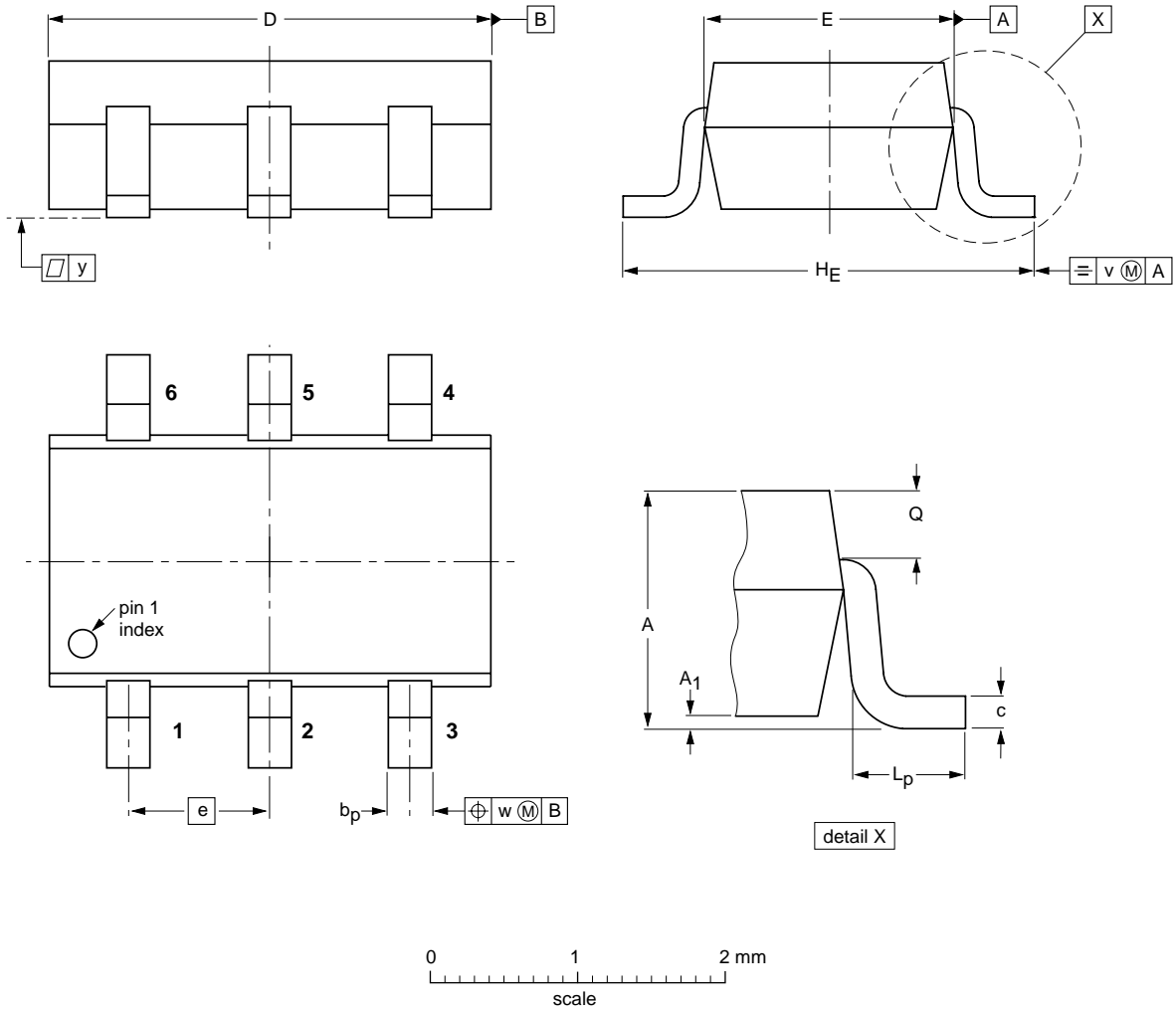

DIMENSIONS (mm are the original dimensions)

UNIT	A	A ₁	b _p	c	D	E	e	H _E	L _p	Q	v	w	y
mm	1.1 0.9	0.1 0.013	0.40 0.25	0.26 0.10	3.1 2.7	1.7 1.3	0.95	3.0 2.5	0.6 0.2	0.33 0.23	0.2	0.2	0.1

OUTLINE VERSION	REFERENCES				EUROPEAN PROJECTION	ISSUE DATE
	IEC	JEDEC	EIAJ			
SOT457			SC-74			-97-02-28- 01-05-04

Quadruple ESD transient voltage suppressor

BZA418A

DATA SHEET STATUS

DOCUMENT STATUS ⁽¹⁾	PRODUCT STATUS ⁽²⁾	DEFINITION
Objective data sheet	Development	This document contains data from the objective specification for product development.
Preliminary data sheet	Qualification	This document contains data from the preliminary specification.
Product data sheet	Production	This document contains the product specification.

Notes

1. Please consult the most recently issued document before initiating or completing a design.
2. The product status of device(s) described in this document may have changed since this document was published and may differ in case of multiple devices. The latest product status information is available on the Internet at URL <http://www.nxp.com>.

DISCLAIMERS

General — Information in this document is believed to be accurate and reliable. However, NXP Semiconductors does not give any representations or warranties, expressed or implied, as to the accuracy or completeness of such information and shall have no liability for the consequences of use of such information.

Right to make changes — NXP Semiconductors reserves the right to make changes to information published in this document, including without limitation specifications and product descriptions, at any time and without notice. This document supersedes and replaces all information supplied prior to the publication hereof.

Suitability for use — NXP Semiconductors products are not designed, authorized or warranted to be suitable for use in medical, military, aircraft, space or life support equipment, nor in applications where failure or malfunction of an NXP Semiconductors product can reasonably be expected to result in personal injury, death or severe property or environmental damage. NXP Semiconductors accepts no liability for inclusion and/or use of NXP Semiconductors products in such equipment or applications and therefore such inclusion and/or use is at the customer's own risk.

Applications — Applications that are described herein for any of these products are for illustrative purposes only. NXP Semiconductors makes no representation or warranty that such applications will be suitable for the specified use without further testing or modification.

Limiting values — Stress above one or more limiting values (as defined in the Absolute Maximum Ratings System of IEC 60134) may cause permanent damage to the device. Limiting values are stress ratings only and operation of the device at these or any other conditions

above those given in the Characteristics sections of this document is not implied. Exposure to limiting values for extended periods may affect device reliability.

Terms and conditions of sale — NXP Semiconductors products are sold subject to the general terms and conditions of commercial sale, as published at <http://www.nxp.com/profile/terms>, including those pertaining to warranty, intellectual property rights infringement and limitation of liability, unless explicitly otherwise agreed to in writing by NXP Semiconductors. In case of any inconsistency or conflict between information in this document and such terms and conditions, the latter will prevail.

No offer to sell or license — Nothing in this document may be interpreted or construed as an offer to sell products that is open for acceptance or the grant, conveyance or implication of any license under any copyrights, patents or other industrial or intellectual property rights.

Export control — This document as well as the item(s) described herein may be subject to export control regulations. Export might require a prior authorization from national authorities.

Quick reference data — The Quick reference data is an extract of the product data given in the Limiting values and Characteristics sections of this document, and as such is not complete, exhaustive or legally binding.

NXP Semiconductors

Customer notification

This data sheet was changed to reflect the new company name NXP Semiconductors, including new legal definitions and disclaimers. No changes were made to the technical content, except for package outline drawings which were updated to the latest version.

Contact information

For additional information please visit: <http://www.nxp.com>

For sales offices addresses send e-mail to: salesaddresses@nxp.com

© NXP B.V. 2009

All rights are reserved. Reproduction in whole or in part is prohibited without the prior written consent of the copyright owner.

The information presented in this document does not form part of any quotation or contract, is believed to be accurate and reliable and may be changed without notice. No liability will be accepted by the publisher for any consequence of its use. Publication thereof does not convey nor imply any license under patent- or other industrial or intellectual property rights.

Printed in The Netherlands

613514/01/pp9

Date of release: 2002 Sep 02

Document order number: 9397 750 10098

founded by

PHILIPS

Mouser Electronics

Authorized Distributor

Click to View Pricing, Inventory, Delivery & Lifecycle Information:

[NXP:](#)

[BZA418A,165](#)