

Complete Lineup for Use in High-temperature, High-pressure Environments or Where Exposed to Chemicals

- The BF-1 is ideal for liquids with low specific resistance, such as wastewater.
- The BF-□(R) is used when a strong mounting is required.
- The BS-1 is used when high-temperature, high-pressure resistant is required.
- The BS-1T is used when corrosion resistance is required.

 Refer to *Safety Precautions for Electrodes and Electrode Holders.*



Ordering Information

■ Electrode Holders

Application	Model
<ul style="list-style-type: none"> • Liquid with low specific resistance For 1-pole electrode 	BF-1
<ul style="list-style-type: none"> • When sturdy mounting is required For 3-pole electrode For 3-pole electrode (2-wire) For 5-pole electrode For 5-pole electrode (2-wire) 	BF-3 BF-3R BF-5 BF-5R
<ul style="list-style-type: none"> • Applications where resistance to high-temperature, high-pressure is required For 1-pole electrodes, 250°C, 1.96 MPa 	BS-1 BS-1S BS-1S1 BS-1S2
<ul style="list-style-type: none"> • High-pressure application where resistance to corrosion is required For 1-pole electrode, SUS304 981 kPa For 1-pole electrode, SUS316 981 kPa For 1-pole electrode, Titanium 981 kPa For 1-pole electrode, Hastelloy B 981 kPa For 1-pole electrode, Hastelloy C 981 kPa 	BS-1T SUS304 BS-1T SUS316 BS-1T TITANIUM BS-1T HAS B BS-1T HAS C

■ Accessories (Order Separately)

Application	Model
Protective Cover (For PS-□S and BF-3/-4/-5)	F03-11
Protective Cover (For B□-1 and B□-1S)	F03-19
M18 Nut (For BS-1)	F03-17
M18 Nut (For BS-1T)	F03-18

Note: Refer to *Installing an Electrode Holder on a Tank* under Level Controller Installation in the Technical Guide for Level Controllers for information on Level Controller installation. Refer to *PS-□S(R) Electrode Holder Accessories (Order Separately)* for dimensions.

Specifications

Item	Model	BF-1	BF-3 (R) (See note 1.)	BF-5 (R) (See note 1.)	BS-1	BS-1T
No. of Electrodes		1	3	5	---	---
Insulator material		PPS resin (Metallic section is SUS.)			Fluorocarbon polymer (PFA)	
Insulation resistance		100 MΩ				
Operating temperature		Electrode section: -10 to 150°C (with no icing) Terminal section: -10 to 70°C (with no icing or condensation)			250°C max.	180°C max.
Operating pressure		Atmospheric pressure			1.96 MPa (See note 2.)	981 kPa (See note 2.)
Applications		Liquids with low specific resistance, such as wastewater and cloudy water	General applications for purified water and wastewater		Boiler water level detection or high-temperature tanks	Acid or alkaline solution level detection

- Note:**
1. Two-wire Electrode Holders (R models) have a built-in resistance of 6.8 kΩ. They should be used with the Two-wire 61F Controllers.
 2. There must be a sufficient ambient temperature in a high-pressure environment to prevent vapor leakage. Use the Electrode Holder according to the following pressure-temperature curve.

Pressure-Temperature Curve

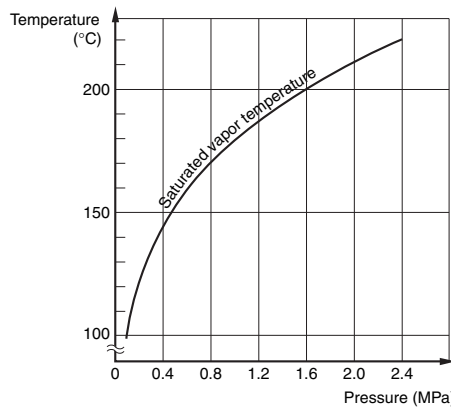

Example
For a pressure of 1.6 MPa, the temperature inside the water tank must be at least 200°C.

■ Appearance

<p>BF-1</p>	<p>BF-3(R) BF-5(R)</p> <p>(See note 1.)</p>	<p>BS-1</p> <p>Material at clamping section: iron (standard) SUS304 and SUS316 are also available. (See note 2.)</p>	<p>BS-1T</p>
--------------------	--	---	---------------------

Note: 1. The F03-11 Protective Cover (sold separately) is available.

2.

Model	Material at tightening section	Screws
BS-1	Iron	M18 P = 1.5
BS-1S	SUS304	M18 P = 1.5
BS-1S1	SUS304	PT1/2
BS-1S2	SUS316	M18 P = 1.5

3. Clamp screws are not provided for hastelloy B, hastelloy C, or titanium Electrode Holders. When placing an order, specify the type of material from the following five: SUS304, SUS316, Hastelloy B, Hastelloy C, or Titanium.

■ Accessories Required for Connecting Electrodes to the BF-□(R) (Order Separately)

Electrode Shorter than 1 m

The following items are required for each pole.

- 1 F03-01 Electrode
- 1 F03-03 Lock Nut

The Electrode can be cut anywhere to a desired control level.

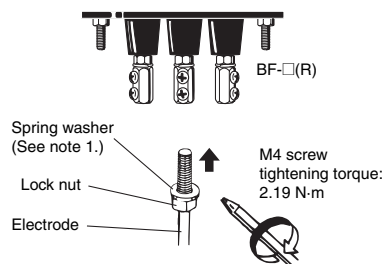

Note: 1. The spring washer comes with the lock nut. Contact your OMRON representative to purchase a replacement if the spring washer wears out or is lost.

2. Refer to F03-□ for details on Electrodes, Connecting Nuts, Lock Nuts, and Separators.

Electrode Longer than 1 m

The following items are required for every additional meter of electrode for each pole.

- 1 F03-01 Electrode
- 1 F03-02 Connecting Nut
- 2 F03-03 Lock Nuts

Use F03-14 1P Separators to prevent the electrodes from touching each other.

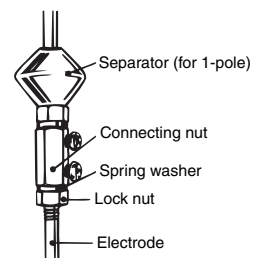

Dimensions

Note: All units are in millimeters unless otherwise indicated.

BF-1

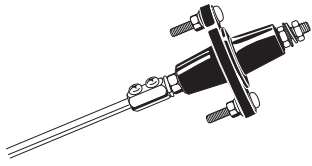

Weight: approx. 75 g

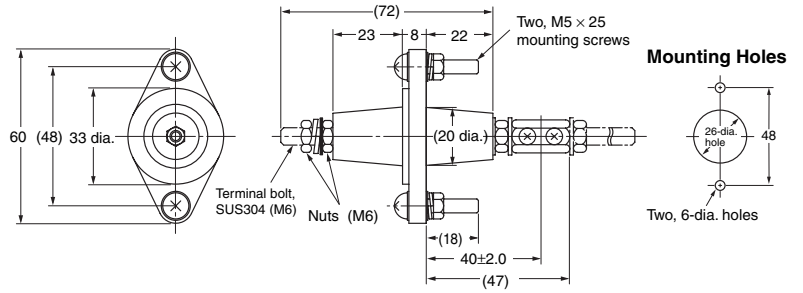

BF-3(R) BF-5(R)

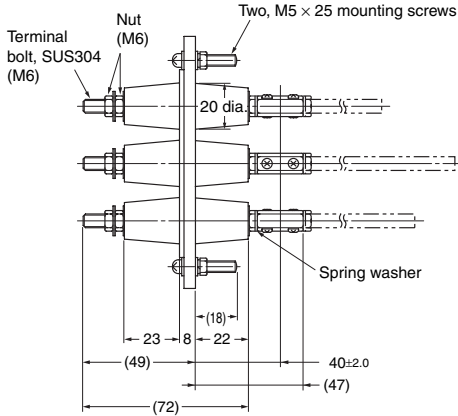
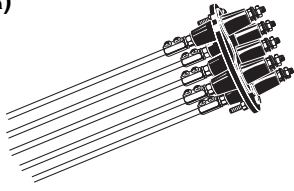

BF-3(R)

Weight
BF-3: approx. 210 g
BF-3R: approx. 215 g

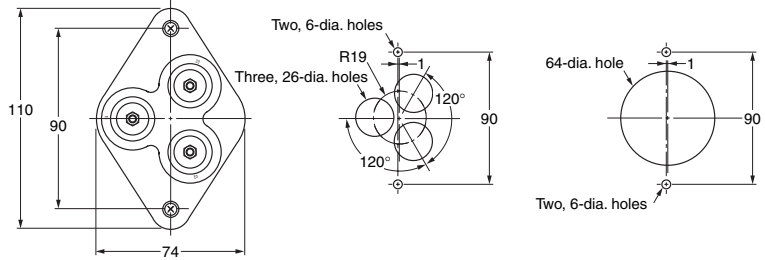

BF-5(R)

Weight
BF-5: approx. 360 g
BF-5R: approx. 365 g

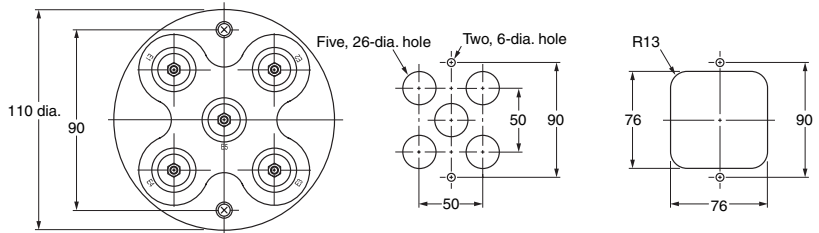

BS-1(S)

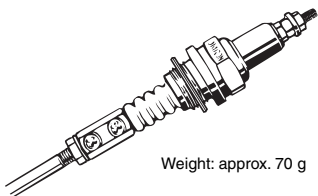

Weight: approx. 70 g

BS-1

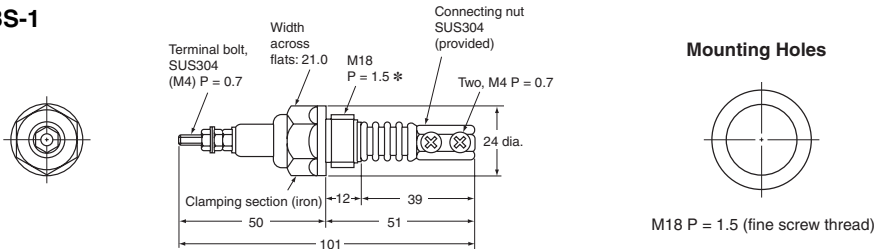

*. If it is not necessary to seal the tank inside and outside.
The Electrode can be secured with F03-17 Nuts.
(Refer to page 1.)

BS-1S BS-1S1 BS-1S2

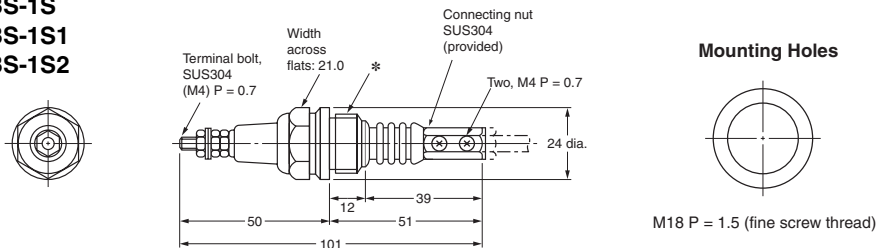

*

BS-1S	BS-1S1	BS-1S2
M18 P=1.5	Taper pipe thread PT1/2 JIS B 0203	M18 P=1.5

BS-1T

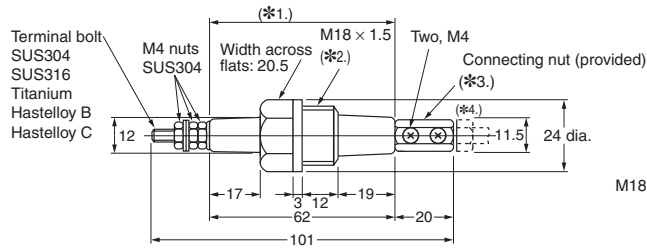
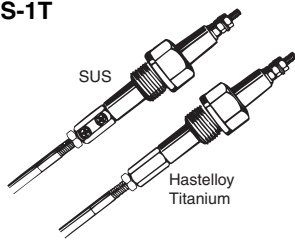

Mounting Holes

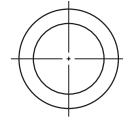

M18 P = 1.5 (fine screw thread)

Material	SUS304	SUS316	Titanium	Hastelloy B	Hastelloy C
Weight	Approx. 55 g	Approx. 55 g	Approx. 45 g	Approx. 65 g	Approx. 60 g

- *1. All of the clamping section is made of fluoro-resin.
- *2. If it is not necessary to seal the tank inside and outside. The Electrode can be secured with F03-18 Nuts. (Refer to page 1.)
- *3. The material of the Connecting Nuts is the same as the material of the BS-1T. Connecting Nuts made of hastelloy B, hastello C, or titanium, however, do not have the screw or screw hole labeled 2-M4 in the figure.
- *4. The section shown with dotted lines is sold separately.

■ Safety Precautions

Refer to *Safety Precautions for All Level Controllers*.

ALL DIMENSIONS SHOWN ARE IN MILLIMETERS.

To convert millimeters into inches, multiply by 0.03937. To convert grams into ounces, multiply by 0.03527.

In the interest of product improvement, specifications are subject to change without notice.

Read and Understand This Catalog

Please read and understand this catalog before purchasing the products. Please consult your OMRON representative if you have any questions or comments.

Warranty and Limitations of Liability

WARRANTY

OMRON's exclusive warranty is that the products are free from defects in materials and workmanship for a period of one year (or other period if specified) from date of sale by OMRON.

OMRON MAKES NO WARRANTY OR REPRESENTATION, EXPRESS OR IMPLIED, REGARDING NON-INFRINGEMENT, MERCHANTABILITY, OR FITNESS FOR PARTICULAR PURPOSE OF THE PRODUCTS. ANY BUYER OR USER ACKNOWLEDGES THAT THE BUYER OR USER ALONE HAS DETERMINED THAT THE PRODUCTS WILL SUITABLY MEET THE REQUIREMENTS OF THEIR INTENDED USE. OMRON DISCLAIMS ALL OTHER WARRANTIES, EXPRESS OR IMPLIED.

LIMITATIONS OF LIABILITY

OMRON SHALL NOT BE RESPONSIBLE FOR SPECIAL, INDIRECT, OR CONSEQUENTIAL DAMAGES, LOSS OF PROFITS OR COMMERCIAL LOSS IN ANY WAY CONNECTED WITH THE PRODUCTS, WHETHER SUCH CLAIM IS BASED ON CONTRACT, WARRANTY, NEGLIGENCE, OR STRICT LIABILITY.

In no event shall the responsibility of OMRON for any act exceed the individual price of the product on which liability is asserted.

IN NO EVENT SHALL OMRON BE RESPONSIBLE FOR WARRANTY, REPAIR, OR OTHER CLAIMS REGARDING THE PRODUCTS UNLESS OMRON'S ANALYSIS CONFIRMS THAT THE PRODUCTS WERE PROPERLY HANDLED, STORED, INSTALLED, AND MAINTAINED AND NOT SUBJECT TO CONTAMINATION, ABUSE, MISUSE, OR INAPPROPRIATE MODIFICATION OR REPAIR.

Application Considerations

SUITABILITY FOR USE

OMRON shall not be responsible for conformity with any standards, codes, or regulations that apply to the combination of products in the customer's application or use of the products.

At the customer's request, OMRON will provide applicable third party certification documents identifying ratings and limitations of use that apply to the products. This information by itself is not sufficient for a complete determination of the suitability of the products in combination with the end product, machine, system, or other application or use.

The following are some examples of applications for which particular attention must be given. This is not intended to be an exhaustive list of all possible uses of the products, nor is it intended to imply that the uses listed may be suitable for the products:

- Outdoor use, uses involving potential chemical contamination or electrical interference, or conditions or uses not described in this catalog.
- Nuclear energy control systems, combustion systems, railroad systems, aviation systems, medical equipment, amusement machines, vehicles, safety equipment, and installations subject to separate industry or government regulations.
- Systems, machines, and equipment that could present a risk to life or property.

Please know and observe all prohibitions of use applicable to the products.

NEVER USE THE PRODUCTS FOR AN APPLICATION INVOLVING SERIOUS RISK TO LIFE OR PROPERTY WITHOUT ENSURING THAT THE SYSTEM AS A WHOLE HAS BEEN DESIGNED TO ADDRESS THE RISKS, AND THAT THE OMRON PRODUCTS ARE PROPERLY RATED AND INSTALLED FOR THE INTENDED USE WITHIN THE OVERALL EQUIPMENT OR SYSTEM.

PROGRAMMABLE PRODUCTS

OMRON shall not be responsible for the user's programming of a programmable product, or any consequence thereof.

Disclaimers

CHANGE IN SPECIFICATIONS

Product specifications and accessories may be changed at any time based on improvements and other reasons.

It is our practice to change model numbers when published ratings or features are changed, or when significant construction changes are made. However, some specifications of the products may be changed without any notice. When in doubt, special model numbers may be assigned to fix or establish key specifications for your application on your request. Please consult with your OMRON representative at any time to confirm actual specifications of purchased products.

DIMENSIONS AND WEIGHTS

Dimensions and weights are nominal and are not to be used for manufacturing purposes, even when tolerances are shown.

PERFORMANCE DATA

Performance data given in this catalog is provided as a guide for the user in determining suitability and does not constitute a warranty. It may represent the result of OMRON's test conditions, and the users must correlate it to actual application requirements. Actual performance is subject to the OMRON Warranty and Limitations of Liability.

ERRORS AND OMISSIONS

The information in this document has been carefully checked and is believed to be accurate; however, no responsibility is assumed for clerical, typographical, or proofreading errors, or omissions.

2012.8

In the interest of product improvement, specifications are subject to change without notice.

OMRON Corporation
Industrial Automation Company

<http://www.ia.omron.com/>

(c)Copyright OMRON Corporation 2012 All Right Reserved.

Mouser Electronics

Authorized Distributor

Click to View Pricing, Inventory, Delivery & Lifecycle Information:

[Omron:](#)

[BF-3](#) [BS-1](#)