

## ULTRALOW NOISE, HIGH PSRR, FAST RF 100-mA LOW-DROPOUT LINEAR REGULATORS

### FEATURES

- 100-mA Low-Dropout Regulator With  $\overline{\text{EN}}$
- Available in 1.8-V, 3.3-V, 4.7-V, and Adj.
- High PSRR (70 dB at 10 kHz)
- Ultralow Noise ( $15 \mu\text{V}_{\text{RMS}}$ )
- Fast Start-Up Time (63  $\mu\text{s}$ )
- Stable With Any 1- $\mu\text{F}$  Ceramic Capacitor
- Excellent Load/Line Transient
- Very Low Dropout Voltage (38 mV at Full Load, TPS79147)
- 5-Pin SOT23 (DBV) Package
- TPS792xx Provides EN Options

### APPLICATIONS

- Cellular and Cordless Telephones
- VCOs
- RF
- Bluetooth™, Wireless LAN
- Handheld Organizers, PDA

### DESCRIPTION

The TPS791xx family of low-dropout (LDO) low-power linear voltage regulators features high power supply rejection ratio (PSRR), ultralow noise, fast start-up, and excellent line and load transient responses in a small outline, SOT23, package. Each device in the family is stable, with a small 1- $\mu\text{F}$  ceramic capacitor on the output. The family uses an advanced, proprietary BiCMOS fabrication process to yield extremely low dropout voltages (e.g., 38 mV at 100 mA, TPS79147). Each device achieves fast start-up times (approximately 63  $\mu\text{s}$  with a 0.001  $\mu\text{F}$  bypass capacitor) while consuming very low quiescent current (170  $\mu\text{A}$  typical). Moreover, when the device is placed in standby mode, the supply current is reduced to less than 1  $\mu\text{A}$ . The TPS79118 exhibits approximately  $15 \mu\text{V}_{\text{RMS}}$  of output voltage noise with a 0.1  $\mu\text{F}$  bypass capacitor. Applications with analog components that are noise sensitive, such as portable RF electronics, benefit from the high PSRR and low noise features as well as the fast response time.

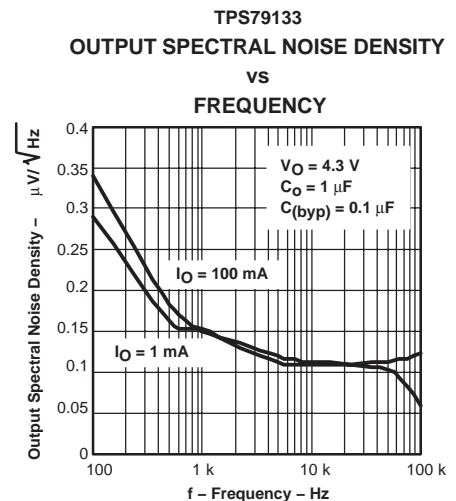
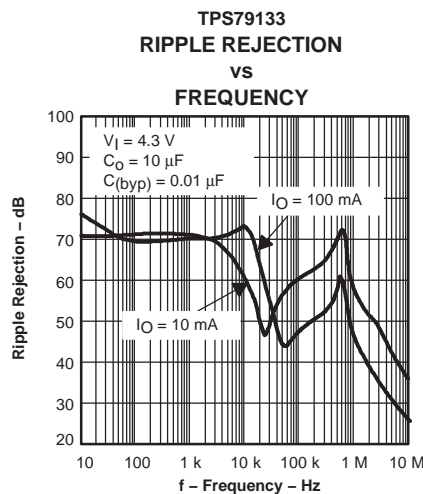
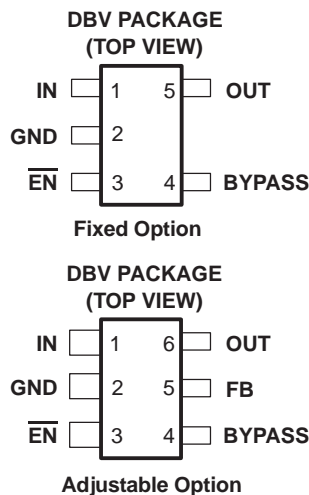

Please be aware that an important notice concerning availability, standard warranty, and use in critical applications of Texas Instruments semiconductor products and disclaimers thereto appears at the end of this data sheet.

Bluetooth is a trademark owned by the Bluetooth SIG, Inc.



These devices have limited built-in ESD protection. The leads should be shorted together or the device placed in conductive foam during storage or handling to prevent electrostatic damage to the MOS gates.

## ORDERING INFORMATION

T <sub>J</sub>	VOLTAGE	PACKAGE	PART NUMBER		SYMBOL
-40°C to 125°C	1.2 to 5.5 V	SOT23 (DBV)	TPS79101DBVT <sup>(1)</sup>	TPS79101DBVR <sup>(2)</sup>	PEUI
	1.8 V		TPS79118DBVT <sup>(1)</sup>	TPS79118DBVR <sup>(2)</sup>	PERI
	3.3 V		TPS79133DBVT <sup>(1)</sup>	TPS79133DBVR <sup>(2)</sup>	PESI
	4.7 V		TPS79147DBVT <sup>(1)</sup>	TPS79147DBVR <sup>(2)</sup>	PETI

(1) The DBVT indicates tape and reel of 250 parts.

(2) The DBVR indicates tape and reel of 3000 parts.

## ABSOLUTE MAXIMUM RATINGS

over operating free-air temperature range unless otherwise noted<sup>(1)</sup>

	TPS79101, TPS79118 TPS79133, TPS79147
Input voltage range <sup>(2)</sup>	-0.3 V to 6 V
Voltage range at $\overline{EN}$	-0.3 V to V <sub>I</sub> + 0.3 V
Voltage on OUT	-0.3 V to 6 V
Peak output current	Internally limited
ESD rating, HBM	2 kV
ESD rating, CDM	500 V
Continuous total power dissipation	See Dissipation Rating Table
Operating virtual junction temperature range, T <sub>J</sub>	-40°C to 150°C
Operating ambient temperature range, T <sub>A</sub>	-40°C to 85°C
Storage temperature range, T <sub>stg</sub>	-65°C to 150°C

(1) Stresses beyond those listed under “absolute maximum ratings” may cause permanent damage to the device. These are stress ratings only, and functional operation of the device at these or any other conditions beyond those indicated under “recommended operating conditions” is not implied. Exposure to absolute-maximum-rated conditions for extended periods may affect device reliability.

(2) All voltage values are with respect to network ground terminal.

## PACKAGE DISSIPATION RATING

BOARD	PACKAGE	R <sub>θJC</sub>	R <sub>θJA</sub>	DERATING FACTOR ABOVE T <sub>A</sub> = 25°C	T <sub>A</sub> ≤ 25°C POWER RATING	T <sub>A</sub> = 70°C POWER RATING	T <sub>A</sub> = 85°C POWER RATING
Low K <sup>(1)</sup>	DBV	63.75°C/W	256°C/W	3.906 mW/°C	391 mW	215 mW	156 mW
High K <sup>(2)</sup>	DBV	63.75°C/W	178.3°C/W	5.609 mW/°C	561 mW	308 mW	224 mW

(1) The JEDEC low-K (1s) board design used to derive this data was a 3-inch × 3-inch, two-layer board with 2-ounce copper traces on top of the board.

(2) The JEDEC high-K (2s2p) board design used to derive this data was a 3-inch × 3-inch, multilayer board with 1-ounce internal power and ground planes and 2-ounce copper traces on top and bottom of the board.

## RECOMMENDED OPERATING CONDITIONS

	MIN	NOM	MAX	UNIT
Input voltage, V <sub>I</sub> <sup>(1)</sup>	2.7		5.5	V
Continuous output current, I <sub>O</sub> <sup>(2)</sup>	0		100	mA
Operating junction temperature, T <sub>J</sub>	-40		125	°C

(1) To calculate the minimum input voltage for your maximum output current, use the following formula:

$$V_I(\text{min}) = V_O(\text{max}) + V_{DO}(\text{max load})$$

(2) Continuous output current and operating junction temperature are limited by internal protection circuitry, but it is not recommended that the device operate under conditions beyond those specified in this table for extended periods of time.

## ELECTRICAL CHARACTERISTICS

over recommended operating free-air temperature range, ( $T_J = -40$  to  $125^\circ\text{C}$ ),  $V_I = V_{O(\text{typ})} + 1\text{ V}$ ,  $I_O = 1\text{ mA}$ ,  $\overline{\text{EN}} = 0\text{ V}$ ,  $C_O = 10\text{ }\mu\text{F}$ ,  $C_{O(\text{byp})} = 0.01\text{ }\mu\text{F}$  (unless otherwise noted)

PARAMETER		TEST CONDITIONS	MIN	TYP	MAX	UNIT
Output voltage	TPS79101	$T_J = 25^\circ\text{C}$ , $1.22\text{ V} \leq V_O \leq 5.2\text{ V}$	$V_O$			V
		$0\text{ }\mu\text{A} < I_O < 100\text{ mA}^{(1)}$ , $1.22\text{ V} \leq V_O \leq 5.2\text{ V}$	$0.98 V_O$	$1.02 V_O$		
	TPS79118	$T_J = 25^\circ\text{C}$	1.8			
		$0\text{ }\mu\text{A} < I_O < 100\text{ mA}$ , $2.8\text{ V} < V_I < 5.5\text{ V}$	1.764	1.836		
	TPS79133	$T_J = 25^\circ\text{C}$	3.3			
		$0\text{ }\mu\text{A} < I_O < 100\text{ mA}$ , $4.3\text{ V} < V_I < 5.5\text{ V}$	3.234	3.366		
TPS79147	$T_J = 25^\circ\text{C}$	4.7				
	$0\text{ }\mu\text{A} < I_O < 100\text{ mA}$ , $5.2\text{ V} < V_I < 5.5\text{ V}$	4.606	4.794			
Quiescent current (GND current)		$0\text{ }\mu\text{A} < I_O < 100\text{ mA}$ , $T_J = 25^\circ\text{C}$	170			$\mu\text{A}$
		$0\text{ }\mu\text{A} < I_O < 100\text{ mA}$	250			
Load regulation		$0\text{ }\mu\text{A} < I_O < 100\text{ mA}$ , $T_J = 25^\circ\text{C}$	5			mV
Output voltage line regulation ( $\Delta V_O/V_O$ ) <sup>(2)</sup>		$V_O + 1\text{ V} < V_I \leq 5.5\text{ V}$ , $T_J = 25^\circ\text{C}$	0.05			%V
		$V_O + 1\text{ V} < V_I \leq 5.5\text{ V}$	0.12			
Output noise voltage (TPS79118)		BW = 100 Hz to 100 kHz, $I_O = 100\text{ mA}$ , $T_J = 25^\circ\text{C}$	$C_{(\text{byp})} = 0.001\text{ }\mu\text{F}$	32		$\mu\text{V}_{\text{RMS}}$
			$C_{(\text{byp})} = 0.0047\text{ }\mu\text{F}$	17		
			$C_{(\text{byp})} = 0.01\text{ }\mu\text{F}$	16		
			$C_{(\text{byp})} = 0.1\text{ }\mu\text{F}$	15		
Time, start-up (TPS79133)		$R_L = 33\text{ }\Omega$ , $C_O = 1\text{ }\mu\text{F}$ , $T_J = 25^\circ\text{C}$	$C_{(\text{byp})} = 0.001\text{ }\mu\text{F}$	53		$\mu\text{s}$
			$C_{(\text{byp})} = 0.0047\text{ }\mu\text{F}$	67		
			$C_{(\text{byp})} = 0.01\text{ }\mu\text{F}$	98		
Output current limit		$V_O = 0\text{ V}^{(1)}$	285	600		mA
UVLO threshold		$V_{CC}$ rising	2.25	2.65		V
UVLO hysteresis		$T_J = 25^\circ\text{C}$ , $V_{CC}$ rising	100			mV

(1) The minimum IN operating voltage is 2.7 V or  $V_{O(\text{typ})} + 1\text{ V}$ , whichever is greater. The maximum IN voltage is 5.5 V. The maximum output current is 100 mA.

(2) If  $V_O \leq 1.8\text{ V}$  then  $V_{I\text{min}} = 2.7\text{ V}$ ,  $V_{I\text{max}} = 5.5\text{ V}$ :

$$\text{Line regulation (mV)} = (\%/V) \times \frac{V_O(V_{I\text{max}} - 2.7\text{ V})}{100} \times 1000$$

If  $V_O \geq 2.5\text{ V}$  then  $V_{I\text{min}} = V_O + 1\text{ V}$ ,  $V_{I\text{max}} = 5.5\text{ V}$ :

$$\text{Line regulation (mV)} = (\%/V) \times \frac{V_O(V_{I\text{max}} - (V_O + 1\text{ V}))}{100} \times 1000$$

### ELECTRICAL CHARACTERISTICS continued

over recommended operating free-air temperature range, ( $T_J = -40$  to  $125$  °C),  $V_I = V_{O(typ)} + 1$  V,  $I_O = 1$  mA,  $\overline{EN} = 0$  V,  $C_O = 10$   $\mu$ F,  $C_{O(byp)} = 0.01$   $\mu$ F (unless otherwise noted)

PARAMETER		TEST CONDITIONS	MIN	TYP	MAX	UNIT
Standby current		$\overline{EN} = V_I$ , $2.7$ V < $V_I$ < $5.5$ V		0.07	1	$\mu$ A
High level enable input voltage		$2.7$ V < $V_I$ < $5.5$ V	2			V
Low level enable input voltage		$2.7$ V < $V_I$ < $5.5$ V			0.7	V
Input current ( $\overline{EN}$ )		$\overline{EN} = V_I$	-1		1	$\mu$ A
Power supply ripple rejection	TPS79118	$f = 100$ Hz, $T_J = 25$ °C, $I_O = 10$ mA		80		dB
		$f = 100$ Hz, $T_J = 25$ °C, $I_O = 100$ mA		75		
		$f = 10$ kHz, $T_J = 25$ °C, $I_O = 100$ mA		72		
		$f = 100$ kHz, $T_J = 25$ °C, $I_O = 100$ mA		45		
	TPS79133	$f = 100$ Hz, $T_J = 25$ °C, $I_O = 10$ mA		70		
		$f = 100$ Hz, $T_J = 25$ °C, $I_O = 100$ mA		75		
		$f = 10$ kHz, $T_J = 25$ °C, $I_O = 100$ mA		73		
		$f = 100$ kHz, $T_J = 25$ °C, $I_O = 100$ mA		37		
Dropout voltage <sup>(1)</sup>	TPS79133	$I_O = 100$ mA, $T_J = 25$ °C		50		mV
		$I_O = 100$ mA			90	
	TPS79147	$I_O = 100$ mA, $T_J = 25$ °C		38		
		$I_O = 100$ mA			70	

(1) IN voltage equals  $V_{O(typ)} - 100$  mV; The TPS79118 dropout voltage is limited by the input voltage range limitations.

### FUNCTIONAL BLOCK DIAGRAM—ADJUSTABLE VERSION

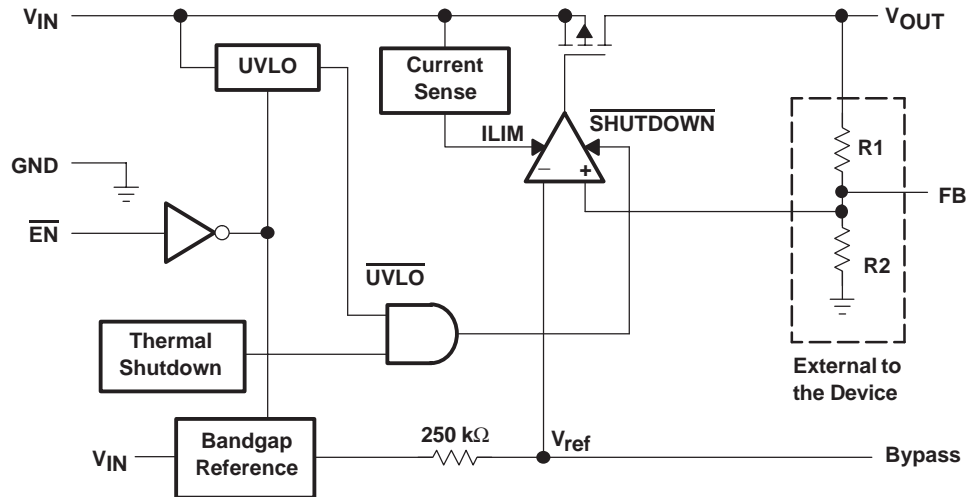

### FUNCTIONAL BLOCK DIAGRAM—FIXED VERSION

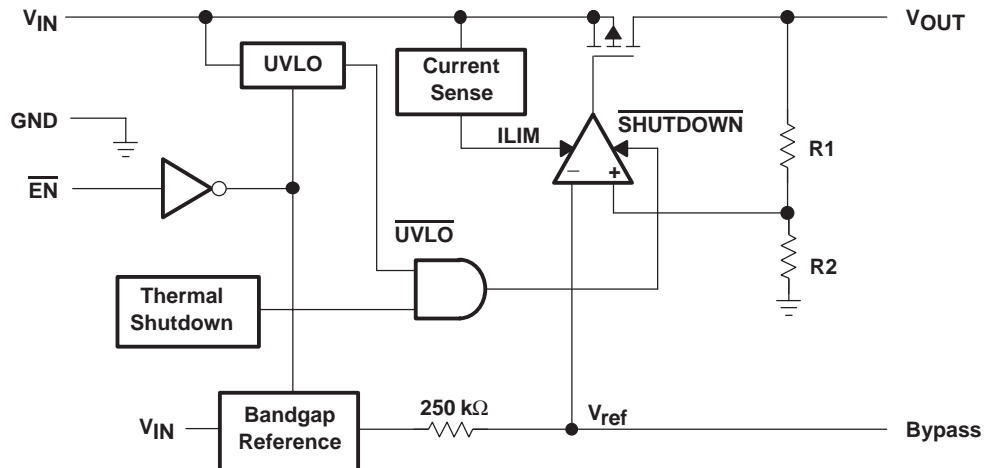

### Terminal Functions

TERMINAL NAME	TERMINAL		I/O	DESCRIPTION
	ADJ	FIXED		
BYPASS	4	4		An external bypass capacitor, connected to this terminal, in conjunction with an internal resistor, creates a low-pass filter to further reduce regulator noise.
$\overline{\text{EN}}$	3	3	I	The $\overline{\text{EN}}$ terminal is an input which enables or shuts down the device. When $\overline{\text{EN}}$ is a logic high, the device will be in shutdown mode. When $\overline{\text{EN}}$ is a logic low, the device will be enabled.
FB	5	N/A	I	This terminal is the feedback input voltage for the adjustable device.
GND	2	2		Regulator ground
IN	1	1	I	The IN terminal is the input to the device.
OUT	6	5	O	The OUT terminal is the regulated output of the device.

TYPICAL CHARACTERISTICS

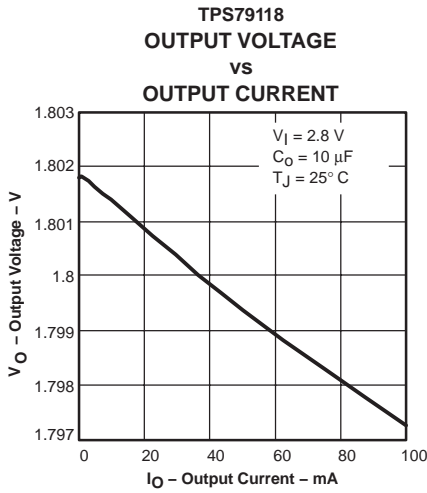

Figure 1

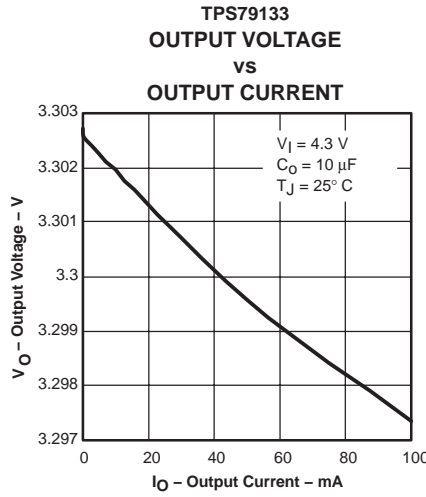

Figure 2

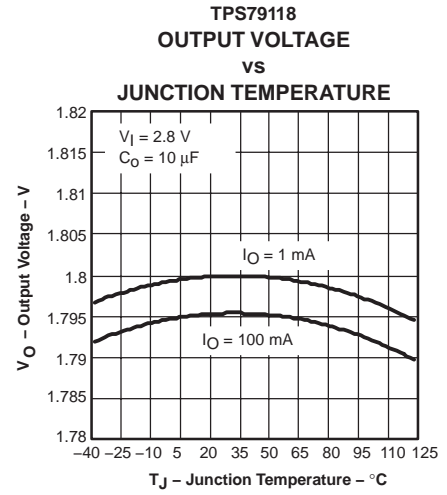

Figure 3

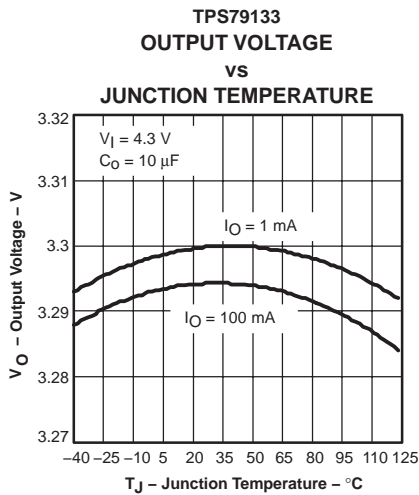

Figure 4

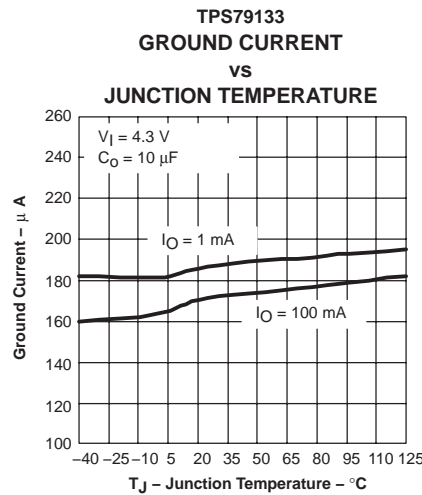

Figure 5

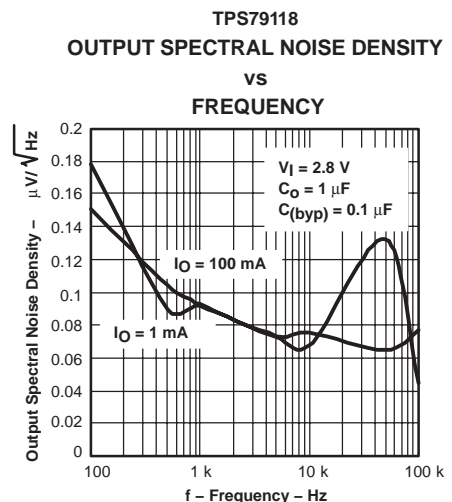

Figure 6

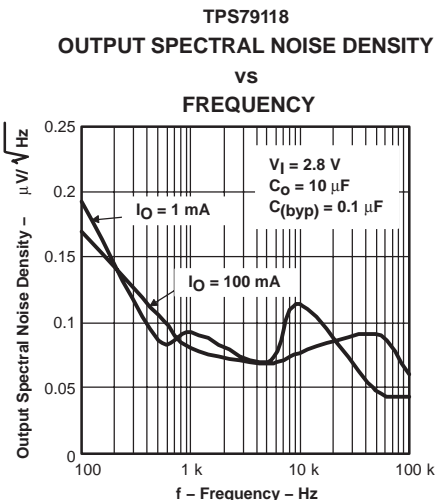

Figure 7

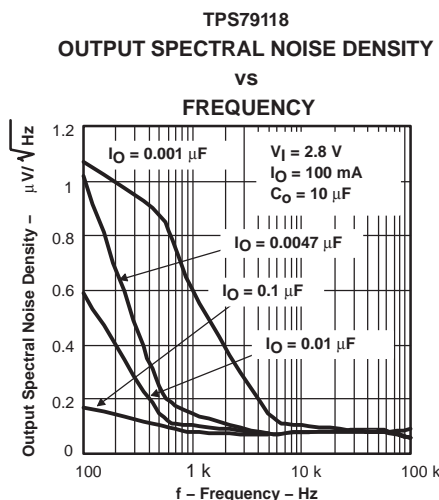

Figure 8

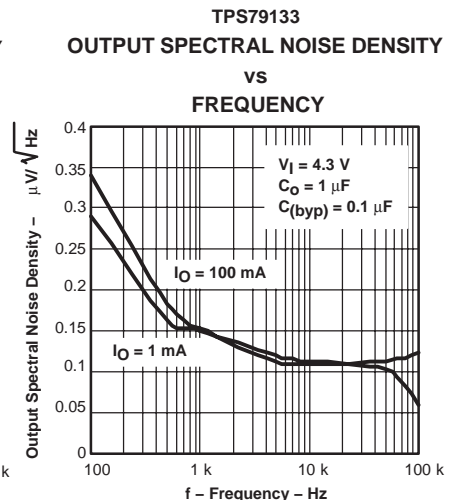
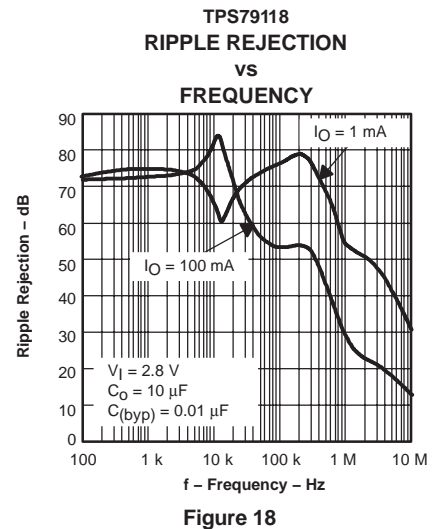
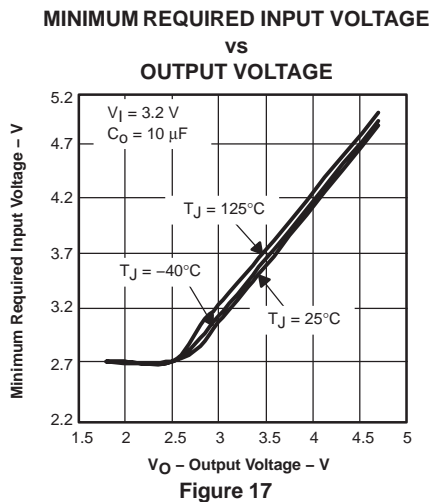
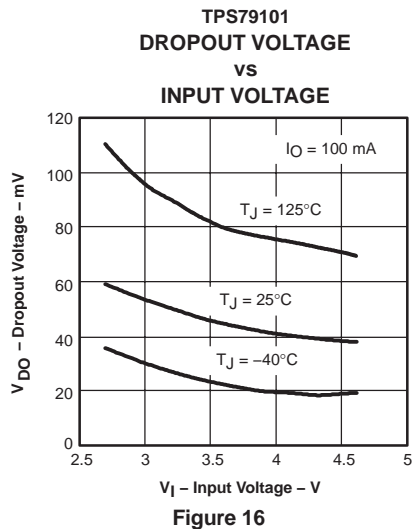
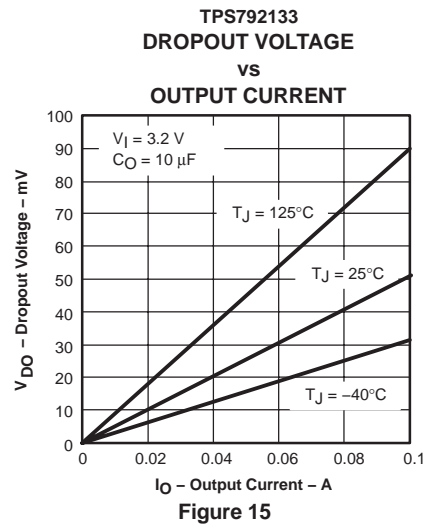
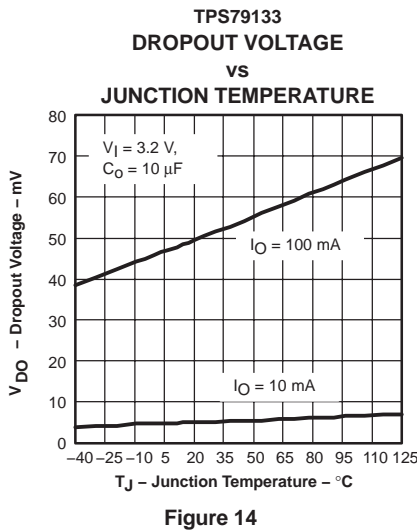
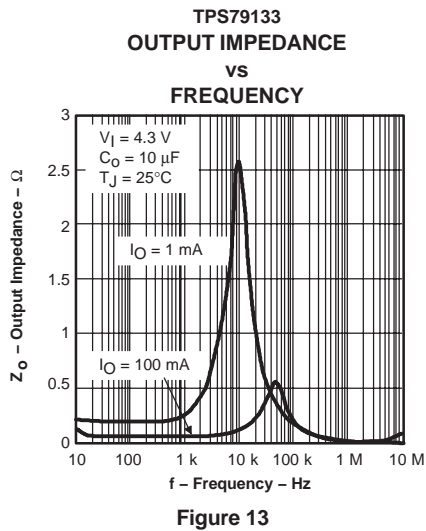
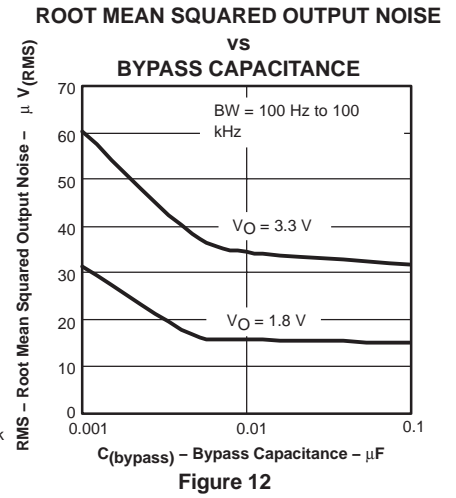
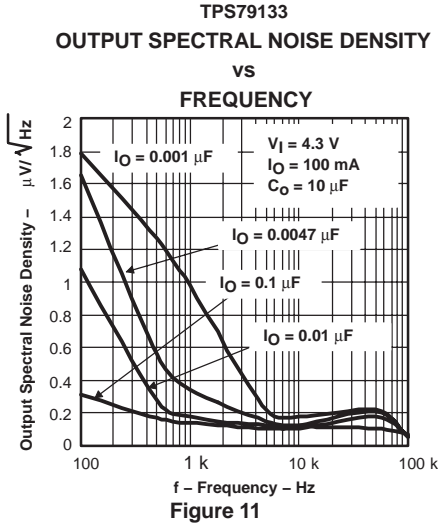
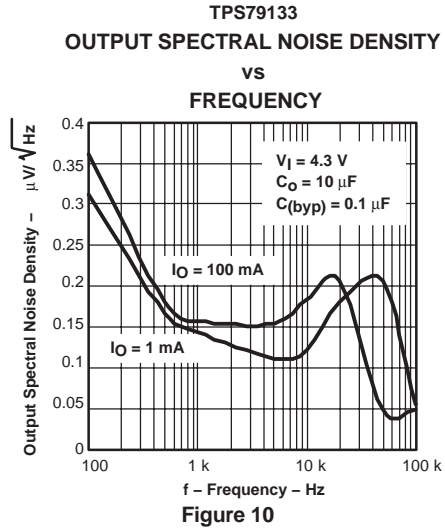

Figure 9

TYPICAL CHARACTERISTICS



TYPICAL CHARACTERISTICS

TPS79118  
RIPPLE REJECTION  
VS  
FREQUENCY

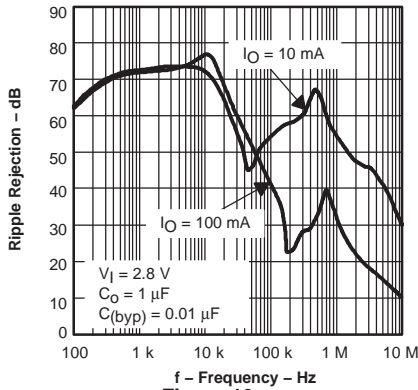

Figure 19

TPS79118  
RIPPLE REJECTION  
VS  
FREQUENCY

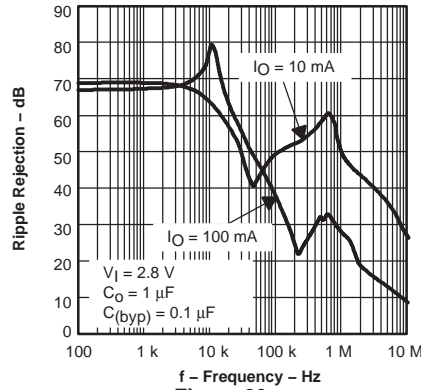

Figure 20

TPS79133  
RIPPLE REJECTION  
VS  
FREQUENCY

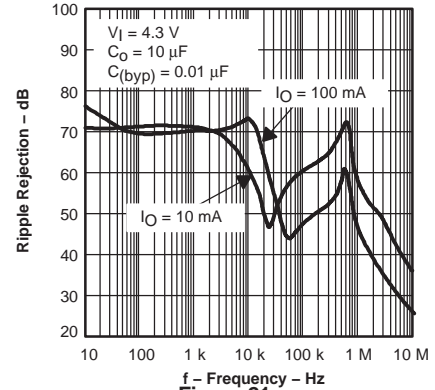

Figure 21

TPS79133  
RIPPLE REJECTION  
VS  
FREQUENCY

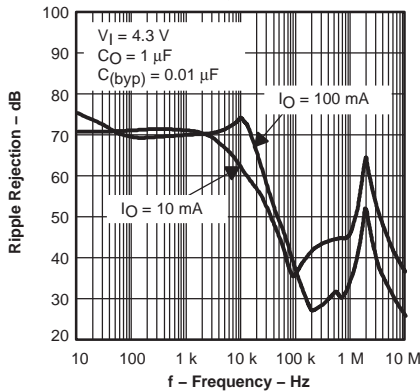

Figure 22

TPS79133  
RIPPLE REJECTION  
VS  
FREQUENCY

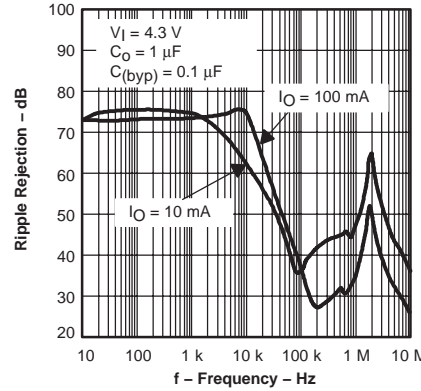

Figure 23

TPS79133  
OUTPUT VOLTAGE, ENABLE VOLTAGE  
VS  
TIME (START-UP)

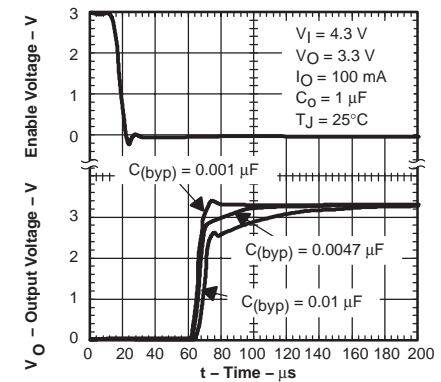

Figure 24

TPS79118  
LINE TRANSIENT RESPONSE

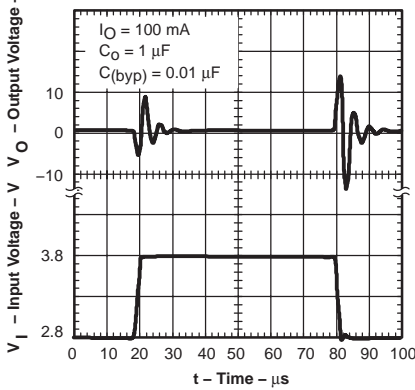

Figure 25

TPS79118  
LOAD TRANSIENT RESPONSE

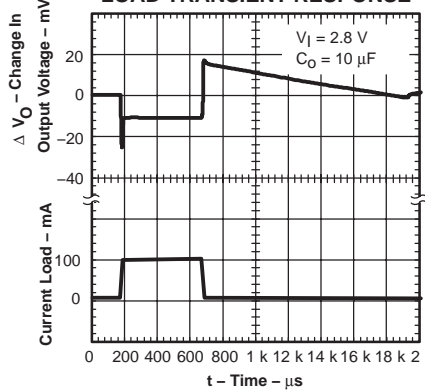

Figure 26

TPS79133  
LINE TRANSIENT RESPONSE

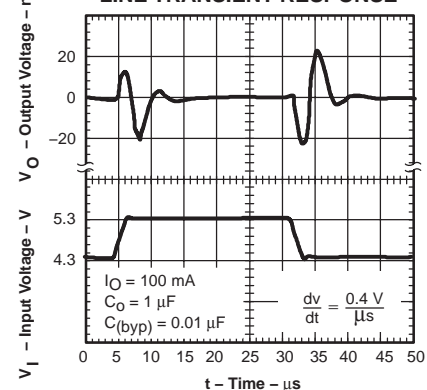
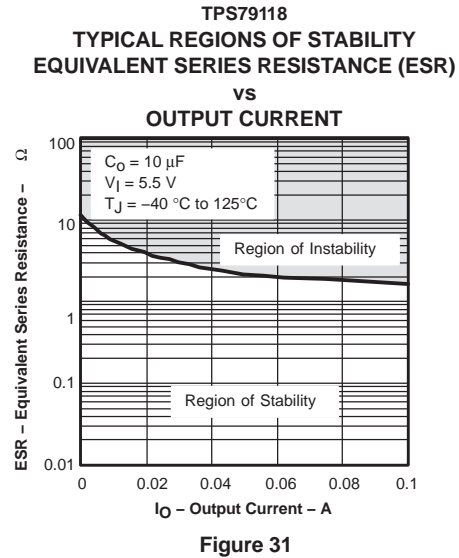
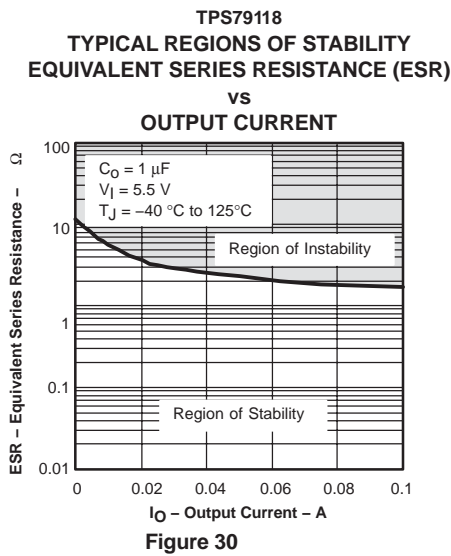
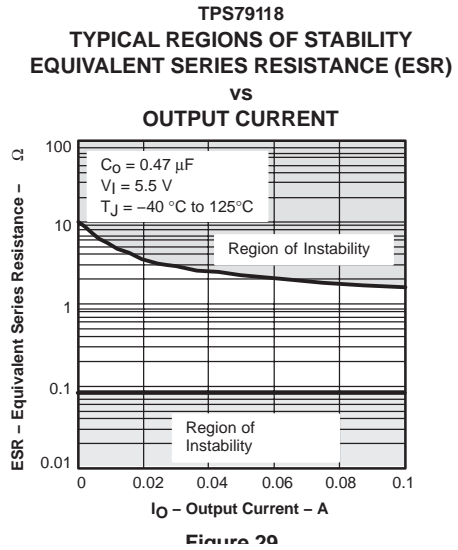
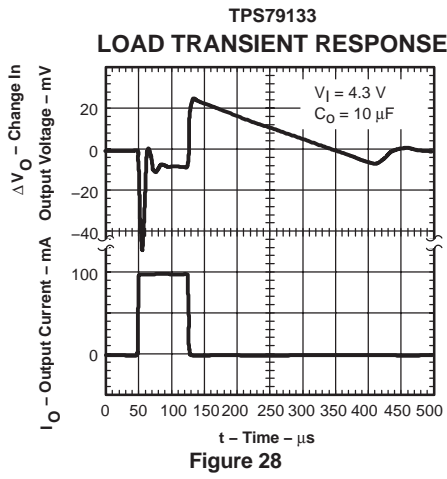

Figure 27



**TYPICAL CHARACTERISTICS**



## APPLICATION INFORMATION

The TPS791xx family of low-dropout (LDO) regulators have been optimized for use in noise-sensitive battery-operated equipment. The device features extremely low dropout voltages, high PSRR, ultralow output noise, low quiescent current (170  $\mu\text{A}$  typically), and enable-input to reduce supply currents to less than 1  $\mu\text{A}$  when the regulator is turned off.

A typical application circuit is shown in Figure 32.

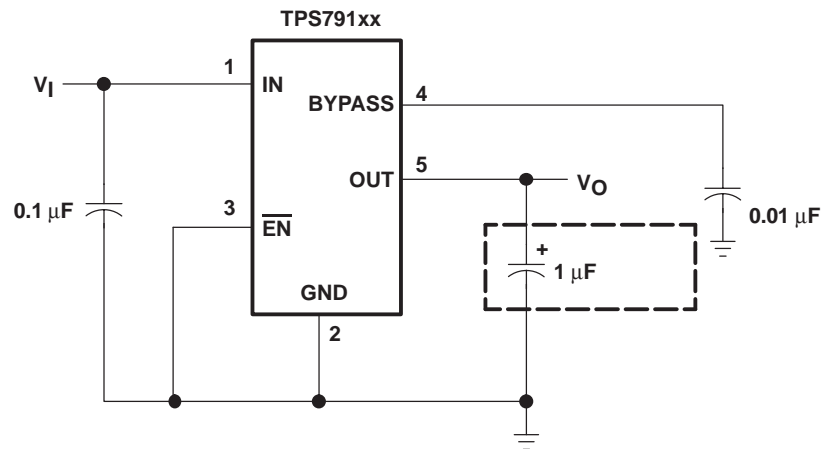

Figure 32. Typical Application Circuit

### EXTERNAL CAPACITOR REQUIREMENTS

A 0.1- $\mu\text{F}$  or larger ceramic input bypass capacitor, connected between IN and GND and located close to the TPS791xx, is required for stability and to improve transient response, noise rejection, and ripple rejection. A higher-value electrolytic input capacitor may be necessary if large, fast-rise-time load transients are anticipated and the device is located several inches from the power source.

Like all low dropout regulators, the TPS791xx requires an output capacitor connected between OUT and GND to stabilize the internal control loop. The minimum recommended capacitance is 1  $\mu\text{F}$ . Any 1  $\mu\text{F}$  or larger ceramic capacitor is suitable. The device is also stable with a 0.47  $\mu\text{F}$  ceramic capacitor with at least 75 m $\Omega$  of ESR.

The internal voltage reference is a key source of noise in an LDO regulator. The TPS791xx has a BYPASS pin which is connected to the voltage reference through a 250-k $\Omega$  internal resistor. The 250-k $\Omega$  internal resistor, in conjunction with an external bypass capacitor connected to the BYPASS pin, creates a low pass filter to reduce the voltage reference noise and, therefore, the noise at the regulator output. In order for the regulator to operate properly, the current flow out of the BYPASS pin must be at a minimum because any leakage current creates an IR drop across the internal resistor thus creating an output error. Therefore, the bypass capacitor must have minimal leakage current.

For example, the TPS79118 exhibits approximately 15  $\mu\text{V}_{\text{RMS}}$  of output voltage noise using a 0.1  $\mu\text{F}$  ceramic bypass capacitor and a 1  $\mu\text{F}$  ceramic output capacitor. Note that the output starts up slower as the bypass capacitance increases due to the RC time constant at the bypass pin that is created by the internal 250 k $\Omega$  resistor and external capacitor.

### BOARD LAYOUT RECOMMENDATION TO IMPROVE PSRR AND NOISE PERFORMANCE

To improve ac measurements like PSRR, output noise, and transient response, it is recommended that the board be designed with separate ground planes for  $V_{\text{IN}}$  and  $V_{\text{OUT}}$ , with each ground plane connected only at the ground pin of the device. In addition, the ground connection for the bypass capacitor should connect directly to the ground pin of the device.

## POWER DISSIPATION AND JUNCTION TEMPERATURE

Specified regulator operation is assured to a junction temperature of 125°C; the maximum junction temperature should be restricted to 125°C under normal operating conditions. This restriction limits the power dissipation the regulator can handle in any given application. To ensure the junction temperature is within acceptable limits, calculate the maximum allowable dissipation,  $P_{D(max)}$ , and the actual dissipation,  $P_D$ , which must be less than or equal to  $P_{D(max)}$ .

The maximum-power-dissipation limit is determined using the following equation:

$$P_{D(max)} = \frac{T_{Jmax} - T_A}{R_{\theta JA}} \quad (1)$$

Where:

$T_{Jmax}$  is the maximum allowable junction temperature.

$R_{\theta JA}$  is the thermal resistance junction-to-ambient for the package, see the dissipation rating table.

$T_A$  is the ambient temperature.

The regulator dissipation is calculated using:

$$P_D = (V_I - V_O) \times I_O \quad (2)$$

Power dissipation resulting from quiescent current is negligible. Excessive power dissipation triggers the thermal protection circuit.

## PROGRAMMING THE TPS79101 ADJUSTABLE LDO REGULATOR

The output voltage of the TPS79101 adjustable regulator is programmed using an external resistor divider as shown in Figure 33. The output voltage is calculated using:

$$V_O = V_{ref} \times \left(1 + \frac{R1}{R2}\right) \quad (3)$$

Where:

$V_{ref} = 1.2246$  V typ (the internal reference voltage)

Resistors R1 and R2 should be chosen for approximately 50- $\mu$ A divider current. Lower value resistors can be used for improved noise performance, but the solution consumes more power. Higher resistor values should be avoided as leakage current into/out of FB across R1/R2 creates an offset voltage that artificially increases/decreases the feedback voltage and thus erroneously decreases/increases  $V_O$ . The recommended design procedure is to choose  $R2 = 30.1$  k $\Omega$  to set the divider current at 50  $\mu$ A,  $C1 = 15$  pF for stability, and then calculate R1 using:

$$R1 = \left(\frac{V_O}{V_{ref}} - 1\right) \times R2 \quad (4)$$

In order to improve the stability of the adjustable version, it is suggested that a small compensation capacitor be placed between OUT and FB. For voltages <1.8 V, the value of this capacitor should be 100 pF. For voltages >1.8 V, the approximate value of this capacitor can be calculated as:

$$C1 = \frac{(3 \times 10^{-7}) \times (R1 + R2)}{(R1 \times R2)} \quad (5)$$

The suggested value of this capacitor for several resistor ratios is shown in the table below. If this capacitor is not used (such as in a unity-gain configuration) or if an output voltage < 1.8 V is chosen, then the minimum recommended output capacitor is 2.2  $\mu$ F instead of 1  $\mu$ F.

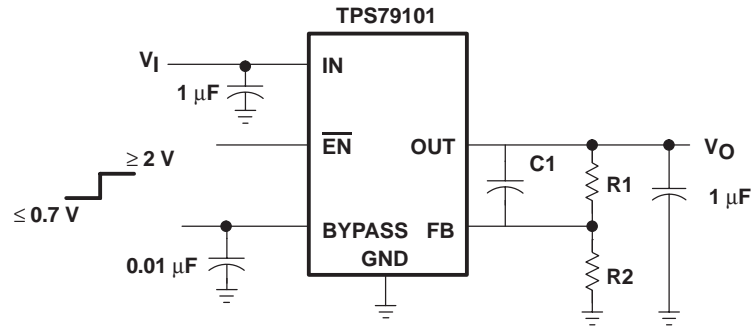

OUTPUT VOLTAGE  
PROGRAMMING GUIDE

OUTPUT VOLTAGE	R1	R2	C1
2.5 V	31.6 kΩ	30.1 kΩ	22 pF
3.3 V	51 kΩ	30.1 kΩ	15 pF
3.6 V	59 kΩ	30.1 kΩ	15 pF

Figure 33. TPS79101 Adjustable LDO Regulator Programming

## REGULATOR PROTECTION

The TPS791xx PMOS-pass transistor has a built-in back diode that conducts reverse current when the input voltage drops below the output voltage (e.g., during power down). Current is conducted from the output to the input and is not internally limited. If extended reverse voltage operation is anticipated, external limiting might be appropriate.

The TPS791xx features internal current limiting and thermal protection. During normal operation, the TPS791xx limits output current to approximately 400 mA. When current limiting engages, the output voltage scales back linearly until the overcurrent condition ends. While current limiting is designed to prevent gross device failure, care should be taken not to exceed the power dissipation ratings of the package or the absolute maximum voltage ratings of the device. If the temperature of the device exceeds approximately 165°C, thermal-protection circuitry shuts it down. Once the device has cooled down to below approximately 140°C, regulator operation resumes.

**PACKAGING INFORMATION**

Orderable Device	Status (1)	Package Type	Package Drawing	Pins	Package Qty	Eco Plan (2)	Lead/Ball Finish (6)	MSL Peak Temp (3)	Op Temp (°C)	Device Marking (4/5)	Samples
TPS79101DBVR	ACTIVE	SOT-23	DBV	6	3000	Green (RoHS & no Sb/Br)	CU NIPDAU	Level-1-260C-UNLIM	-40 to 125	PEUI	<a href="#">Samples</a>
TPS79101DBVRG4	ACTIVE	SOT-23	DBV	6	3000	Green (RoHS & no Sb/Br)	CU NIPDAU	Level-1-260C-UNLIM	-40 to 125	PEUI	<a href="#">Samples</a>
TPS79101DBVT	ACTIVE	SOT-23	DBV	6	250	Green (RoHS & no Sb/Br)	CU NIPDAU	Level-1-260C-UNLIM	-40 to 125	PEUI	<a href="#">Samples</a>
TPS79101DBVTG4	ACTIVE	SOT-23	DBV	6	250	Green (RoHS & no Sb/Br)	CU NIPDAU	Level-1-260C-UNLIM	-40 to 125	PEUI	<a href="#">Samples</a>
TPS79118DBVR	ACTIVE	SOT-23	DBV	5	3000	Green (RoHS & no Sb/Br)	CU NIPDAU	Level-1-260C-UNLIM	-40 to 125	PERI	<a href="#">Samples</a>
TPS79118DBVRG4	ACTIVE	SOT-23	DBV	5	3000	Green (RoHS & no Sb/Br)	CU NIPDAU	Level-1-260C-UNLIM	-40 to 125	PERI	<a href="#">Samples</a>
TPS79118DBVT	ACTIVE	SOT-23	DBV	5	250	Green (RoHS & no Sb/Br)	CU NIPDAU	Level-1-260C-UNLIM	-40 to 125	PERI	<a href="#">Samples</a>
TPS79118DBVTG4	ACTIVE	SOT-23	DBV	5	250	Green (RoHS & no Sb/Br)	CU NIPDAU	Level-1-260C-UNLIM	-40 to 125	PERI	<a href="#">Samples</a>
TPS79133DBVR	ACTIVE	SOT-23	DBV	5	3000	Green (RoHS & no Sb/Br)	CU NIPDAU	Level-1-260C-UNLIM	-40 to 125	PESI	<a href="#">Samples</a>
TPS79133DBVRG4	ACTIVE	SOT-23	DBV	5	3000	Green (RoHS & no Sb/Br)	CU NIPDAU	Level-1-260C-UNLIM	-40 to 125	PESI	<a href="#">Samples</a>
TPS79133DBVT	ACTIVE	SOT-23	DBV	5	250	Green (RoHS & no Sb/Br)	CU NIPDAU	Level-1-260C-UNLIM	-40 to 125	PESI	<a href="#">Samples</a>
TPS79133DBVTG4	ACTIVE	SOT-23	DBV	5	250	Green (RoHS & no Sb/Br)	CU NIPDAU	Level-1-260C-UNLIM	-40 to 125	PESI	<a href="#">Samples</a>
TPS79147DBVR	ACTIVE	SOT-23	DBV	5	3000	Green (RoHS & no Sb/Br)	CU NIPDAU	Level-1-260C-UNLIM	-40 to 125	PETI	<a href="#">Samples</a>
TPS79147DBVT	ACTIVE	SOT-23	DBV	5	250	Green (RoHS & no Sb/Br)	CU NIPDAU	Level-1-260C-UNLIM	-40 to 125	PETI	<a href="#">Samples</a>
TPS79147DBVTG4	ACTIVE	SOT-23	DBV	5	250	Green (RoHS & no Sb/Br)	CU NIPDAU	Level-1-260C-UNLIM	-40 to 125	PETI	<a href="#">Samples</a>

(1) The marketing status values are defined as follows:

**ACTIVE:** Product device recommended for new designs.

**LIFEBUY:** TI has announced that the device will be discontinued, and a lifetime-buy period is in effect.

**NRND:** Not recommended for new designs. Device is in production to support existing customers, but TI does not recommend using this part in a new design.

**PREVIEW:** Device has been announced but is not in production. Samples may or may not be available.

**OBSOLETE:** TI has discontinued the production of the device.

<sup>(2)</sup> Eco Plan - The planned eco-friendly classification: Pb-Free (RoHS), Pb-Free (RoHS Exempt), or Green (RoHS & no Sb/Br) - please check <http://www.ti.com/productcontent> for the latest availability information and additional product content details.

**TBD:** The Pb-Free/Green conversion plan has not been defined.

**Pb-Free (RoHS):** TI's terms "Lead-Free" or "Pb-Free" mean semiconductor products that are compatible with the current RoHS requirements for all 6 substances, including the requirement that lead not exceed 0.1% by weight in homogeneous materials. Where designed to be soldered at high temperatures, TI Pb-Free products are suitable for use in specified lead-free processes.

**Pb-Free (RoHS Exempt):** This component has a RoHS exemption for either 1) lead-based flip-chip solder bumps used between the die and package, or 2) lead-based die adhesive used between the die and leadframe. The component is otherwise considered Pb-Free (RoHS compatible) as defined above.

**Green (RoHS & no Sb/Br):** TI defines "Green" to mean Pb-Free (RoHS compatible), and free of Bromine (Br) and Antimony (Sb) based flame retardants (Br or Sb do not exceed 0.1% by weight in homogeneous material)

<sup>(3)</sup> MSL, Peak Temp. - The Moisture Sensitivity Level rating according to the JEDEC industry standard classifications, and peak solder temperature.

<sup>(4)</sup> There may be additional marking, which relates to the logo, the lot trace code information, or the environmental category on the device.

<sup>(5)</sup> Multiple Device Markings will be inside parentheses. Only one Device Marking contained in parentheses and separated by a "~" will appear on a device. If a line is indented then it is a continuation of the previous line and the two combined represent the entire Device Marking for that device.

<sup>(6)</sup> Lead/Ball Finish - Orderable Devices may have multiple material finish options. Finish options are separated by a vertical ruled line. Lead/Ball Finish values may wrap to two lines if the finish value exceeds the maximum column width.

**Important Information and Disclaimer:** The information provided on this page represents TI's knowledge and belief as of the date that it is provided. TI bases its knowledge and belief on information provided by third parties, and makes no representation or warranty as to the accuracy of such information. Efforts are underway to better integrate information from third parties. TI has taken and continues to take reasonable steps to provide representative and accurate information but may not have conducted destructive testing or chemical analysis on incoming materials and chemicals. TI and TI suppliers consider certain information to be proprietary, and thus CAS numbers and other limited information may not be available for release.

In no event shall TI's liability arising out of such information exceed the total purchase price of the TI part(s) at issue in this document sold by TI to Customer on an annual basis.

**OTHER QUALIFIED VERSIONS OF TPS79101, TPS79118, TPS79133, TPS79147 :**

● Automotive: [TPS79101-Q1](#), [TPS79118-Q1](#), [TPS79133-Q1](#), [TPS79147-Q1](#)

● Enhanced Product: [TPS79101-EP](#), [TPS79118-EP](#), [TPS79133-EP](#), [TPS79147-EP](#)

NOTE: Qualified Version Definitions:

● Automotive - Q100 devices qualified for high-reliability automotive applications targeting zero defects

- Enhanced Product - Supports Defense, Aerospace and Medical Applications

**TAPE AND REEL INFORMATION**

**QUADRANT ASSIGNMENTS FOR PIN 1 ORIENTATION IN TAPE**

\*All dimensions are nominal

Device	Package Type	Package Drawing	Pins	SPQ	Reel Diameter (mm)	Reel Width W1 (mm)	A0 (mm)	B0 (mm)	K0 (mm)	P1 (mm)	W (mm)	Pin1 Quadrant
TPS79101DBVR	SOT-23	DBV	6	3000	178.0	9.0	3.23	3.17	1.37	4.0	8.0	Q3
TPS79101DBVT	SOT-23	DBV	6	250	178.0	9.0	3.23	3.17	1.37	4.0	8.0	Q3
TPS79118DBVR	SOT-23	DBV	5	3000	178.0	9.0	3.23	3.17	1.37	4.0	8.0	Q3
TPS79118DBVT	SOT-23	DBV	5	250	178.0	9.0	3.23	3.17	1.37	4.0	8.0	Q3
TPS79133DBVR	SOT-23	DBV	5	3000	178.0	9.0	3.23	3.17	1.37	4.0	8.0	Q3
TPS79133DBVT	SOT-23	DBV	5	250	178.0	9.0	3.23	3.17	1.37	4.0	8.0	Q3
TPS79147DBVR	SOT-23	DBV	5	3000	178.0	9.0	3.3	3.2	1.4	4.0	8.0	Q3
TPS79147DBVT	SOT-23	DBV	5	250	178.0	9.0	3.23	3.17	1.37	4.0	8.0	Q3



**TAPE AND REEL BOX DIMENSIONS**

\*All dimensions are nominal

Device	Package Type	Package Drawing	Pins	SPQ	Length (mm)	Width (mm)	Height (mm)
TPS79101DBVR	SOT-23	DBV	6	3000	180.0	180.0	18.0
TPS79101DBVT	SOT-23	DBV	6	250	180.0	180.0	18.0
TPS79118DBVR	SOT-23	DBV	5	3000	180.0	180.0	18.0
TPS79118DBVT	SOT-23	DBV	5	250	180.0	180.0	18.0
TPS79133DBVR	SOT-23	DBV	5	3000	180.0	180.0	18.0
TPS79133DBVT	SOT-23	DBV	5	250	180.0	180.0	18.0
TPS79147DBVR	SOT-23	DBV	5	3000	180.0	180.0	18.0
TPS79147DBVT	SOT-23	DBV	5	250	180.0	180.0	18.0

DBV (R-PDSO-G5)

PLASTIC SMALL-OUTLINE PACKAGE



- NOTES:
- A. All linear dimensions are in millimeters.
  - B. This drawing is subject to change without notice.
  - C. Body dimensions do not include mold flash or protrusion. Mold flash and protrusion shall not exceed 0.15 per side.
  - D. Falls within JEDEC MO-178 Variation AA.

DBV (R-PDSO-G5)

PLASTIC SMALL OUTLINE



- NOTES:
- A. All linear dimensions are in millimeters.
  - B. This drawing is subject to change without notice.
  - C. Customers should place a note on the circuit board fabrication drawing not to alter the center solder mask defined pad.
  - D. Publication IPC-7351 is recommended for alternate designs.
  - E. Laser cutting apertures with trapezoidal walls and also rounding corners will offer better paste release. Customers should contact their board assembly site for stencil design recommendations. Example stencil design based on a 50% volumetric metal load solder paste. Refer to IPC-7525 for other stencil recommendations.

# MECHANICAL DATA

DBV (R-PDSO-G6)

PLASTIC SMALL-OUTLINE PACKAGE



- NOTES:
- A. All linear dimensions are in millimeters.
  - B. This drawing is subject to change without notice.
  - C. Body dimensions do not include mold flash or protrusion. Mold flash and protrusion shall not exceed 0.15 per side.
  - D. Leads 1,2,3 may be wider than leads 4,5,6 for package orientation.
- ⚠ Falls within JEDEC MO-178 Variation AB, except minimum lead width.

DBV (R-PDSO-G6)

PLASTIC SMALL OUTLINE



- NOTES:
- A. All linear dimensions are in millimeters.
  - B. This drawing is subject to change without notice.
  - C. Customers should place a note on the circuit board fabrication drawing not to alter the center solder mask defined pad.
  - D. Publication IPC-7351 is recommended for alternate designs.
  - E. Laser cutting apertures with trapezoidal walls and also rounding corners will offer better paste release. Customers should contact their board assembly site for stencil design recommendations. Example stencil design based on a 50% volumetric metal load solder paste. Refer to IPC-7525 for other stencil recommendations.

## IMPORTANT NOTICE

Texas Instruments Incorporated and its subsidiaries (TI) reserve the right to make corrections, enhancements, improvements and other changes to its semiconductor products and services per JESD46, latest issue, and to discontinue any product or service per JESD48, latest issue. Buyers should obtain the latest relevant information before placing orders and should verify that such information is current and complete. All semiconductor products (also referred to herein as "components") are sold subject to TI's terms and conditions of sale supplied at the time of order acknowledgment.

TI warrants performance of its components to the specifications applicable at the time of sale, in accordance with the warranty in TI's terms and conditions of sale of semiconductor products. Testing and other quality control techniques are used to the extent TI deems necessary to support this warranty. Except where mandated by applicable law, testing of all parameters of each component is not necessarily performed.

TI assumes no liability for applications assistance or the design of Buyers' products. Buyers are responsible for their products and applications using TI components. To minimize the risks associated with Buyers' products and applications, Buyers should provide adequate design and operating safeguards.

TI does not warrant or represent that any license, either express or implied, is granted under any patent right, copyright, mask work right, or other intellectual property right relating to any combination, machine, or process in which TI components or services are used. Information published by TI regarding third-party products or services does not constitute a license to use such products or services or a warranty or endorsement thereof. Use of such information may require a license from a third party under the patents or other intellectual property of the third party, or a license from TI under the patents or other intellectual property of TI.

Reproduction of significant portions of TI information in TI data books or data sheets is permissible only if reproduction is without alteration and is accompanied by all associated warranties, conditions, limitations, and notices. TI is not responsible or liable for such altered documentation. Information of third parties may be subject to additional restrictions.

Resale of TI components or services with statements different from or beyond the parameters stated by TI for that component or service voids all express and any implied warranties for the associated TI component or service and is an unfair and deceptive business practice. TI is not responsible or liable for any such statements.

Buyer acknowledges and agrees that it is solely responsible for compliance with all legal, regulatory and safety-related requirements concerning its products, and any use of TI components in its applications, notwithstanding any applications-related information or support that may be provided by TI. Buyer represents and agrees that it has all the necessary expertise to create and implement safeguards which anticipate dangerous consequences of failures, monitor failures and their consequences, lessen the likelihood of failures that might cause harm and take appropriate remedial actions. Buyer will fully indemnify TI and its representatives against any damages arising out of the use of any TI components in safety-critical applications.

In some cases, TI components may be promoted specifically to facilitate safety-related applications. With such components, TI's goal is to help enable customers to design and create their own end-product solutions that meet applicable functional safety standards and requirements. Nonetheless, such components are subject to these terms.

No TI components are authorized for use in FDA Class III (or similar life-critical medical equipment) unless authorized officers of the parties have executed a special agreement specifically governing such use.

Only those TI components which TI has specifically designated as military grade or "enhanced plastic" are designed and intended for use in military/aerospace applications or environments. Buyer acknowledges and agrees that any military or aerospace use of TI components which have **not** been so designated is solely at the Buyer's risk, and that Buyer is solely responsible for compliance with all legal and regulatory requirements in connection with such use.

TI has specifically designated certain components as meeting ISO/TS16949 requirements, mainly for automotive use. In any case of use of non-designated products, TI will not be responsible for any failure to meet ISO/TS16949.

### Products

Audio	<a href="http://www.ti.com/audio">www.ti.com/audio</a>
Amplifiers	<a href="http://amplifier.ti.com">amplifier.ti.com</a>
Data Converters	<a href="http://dataconverter.ti.com">dataconverter.ti.com</a>
DLP® Products	<a href="http://www.dlp.com">www.dlp.com</a>
DSP	<a href="http://dsp.ti.com">dsp.ti.com</a>
Clocks and Timers	<a href="http://www.ti.com/clocks">www.ti.com/clocks</a>
Interface	<a href="http://interface.ti.com">interface.ti.com</a>
Logic	<a href="http://logic.ti.com">logic.ti.com</a>
Power Mgmt	<a href="http://power.ti.com">power.ti.com</a>
Microcontrollers	<a href="http://microcontroller.ti.com">microcontroller.ti.com</a>
RFID	<a href="http://www.ti-rfid.com">www.ti-rfid.com</a>
OMAP Applications Processors	<a href="http://www.ti.com/omap">www.ti.com/omap</a>
Wireless Connectivity	<a href="http://www.ti.com/wirelessconnectivity">www.ti.com/wirelessconnectivity</a>

### Applications

Automotive and Transportation	<a href="http://www.ti.com/automotive">www.ti.com/automotive</a>
Communications and Telecom	<a href="http://www.ti.com/communications">www.ti.com/communications</a>
Computers and Peripherals	<a href="http://www.ti.com/computers">www.ti.com/computers</a>
Consumer Electronics	<a href="http://www.ti.com/consumer-apps">www.ti.com/consumer-apps</a>
Energy and Lighting	<a href="http://www.ti.com/energy">www.ti.com/energy</a>
Industrial	<a href="http://www.ti.com/industrial">www.ti.com/industrial</a>
Medical	<a href="http://www.ti.com/medical">www.ti.com/medical</a>
Security	<a href="http://www.ti.com/security">www.ti.com/security</a>
Space, Avionics and Defense	<a href="http://www.ti.com/space-avionics-defense">www.ti.com/space-avionics-defense</a>
Video and Imaging	<a href="http://www.ti.com/video">www.ti.com/video</a>

### TI E2E Community

[e2e.ti.com](http://e2e.ti.com)