

# 74AHC1GU04

## Inverter

Rev. 05 — 10 July 2007

Product data sheet

## 1. General description

The 74AHC1GU04 is a high-speed Si-gate CMOS device. It provides an inverting single stage function.

## 2. Features

- Symmetrical output impedance
- High noise immunity
- Low power dissipation
- Balanced propagation delays
- ESD protection:
  - ◆ HBM JESD22-A114E: exceeds 2000 V
  - ◆ MM JESD22-A115-A: exceeds 200 V
  - ◆ CDM JESD22-C101C: exceeds 1000 V
- Specified from  $-40\text{ }^{\circ}\text{C}$  to  $+125\text{ }^{\circ}\text{C}$

## 3. Ordering information

Table 1. Ordering information

Type number	Package			
	Temperature range	Name	Description	Version
74AHC1GU04GW	$-40\text{ }^{\circ}\text{C}$ to $+125\text{ }^{\circ}\text{C}$	TSSOP5	plastic thin shrink small outline package; 5 leads; body width 1.25 mm	SOT353-1
74AHC1GU04GV	$-40\text{ }^{\circ}\text{C}$ to $+125\text{ }^{\circ}\text{C}$	SC-74A	plastic surface-mounted package; 5 leads	SOT753

## 4. Marking

Table 2. Marking codes

Type number	Marking
74AHC1GU04GW	AD
74AHC1GU04GV	AU4

## 5. Functional diagram

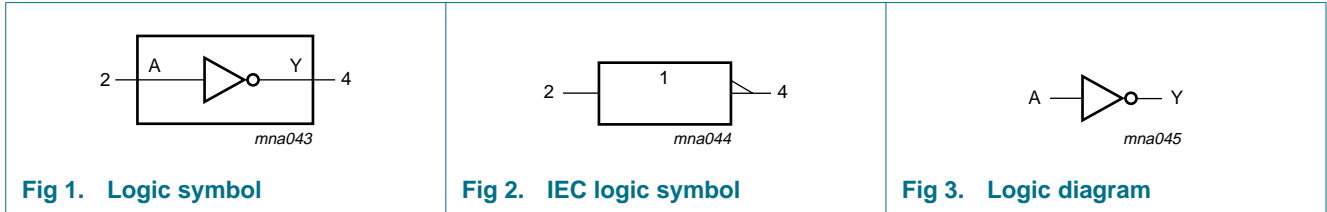

## 6. Pinning information

### 6.1 Pinning

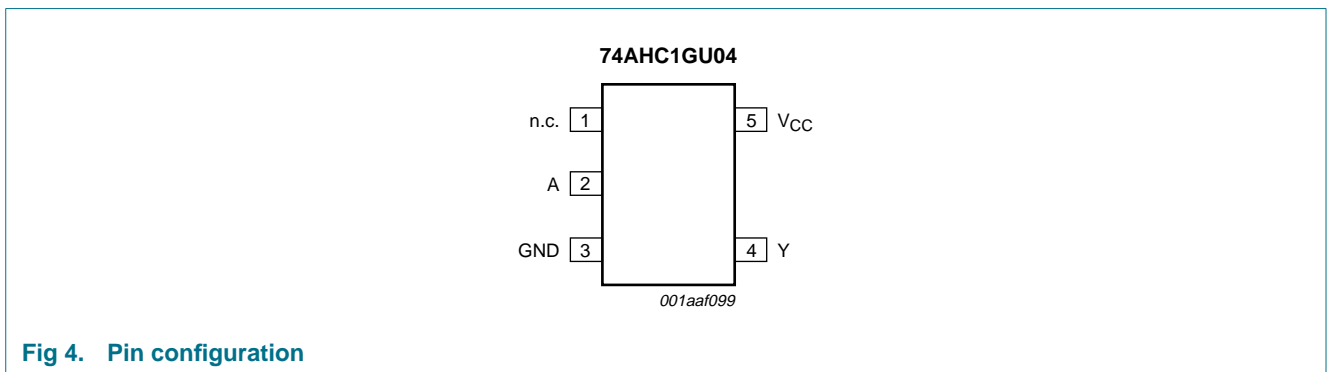

### 6.2 Pin description

Table 3. Pin description

Symbol	Pin	Description
n.c.	1	not connected
A	2	data input
GND	3	ground (0 V)
Y	4	data output
V <sub>CC</sub>	5	supply voltage

## 7. Functional description

Table 4. Function table

H = HIGH voltage level; L = LOW voltage level

Input	Output
A	Y
L	H
H	L

## 8. Limiting values

**Table 5. Limiting values**

In accordance with the Absolute Maximum Rating System (IEC 60134).

Symbol	Parameter	Conditions	Min	Max	Unit
$V_{CC}$	supply voltage		-0.5	+7.0	V
$I_{IK}$	input clamping current	$V_I < -0.5$ V	-20	-	mA
$V_I$	input voltage		[1] -0.5	+7.0	V
$I_{OK}$	output clamping current	$V_O < -0.5$ V or $V_O > V_{CC} + 0.5$ V	-	$\pm 20$	mA
$I_O$	output current	$-0.5$ V $< V_O < V_{CC} + 0.5$ V	-	$\pm 25$	mA
$I_{CC}$	supply current		-	75	mA
$I_{GND}$	ground current		-75	-	mA
$T_{stg}$	storage temperature		-65	+150	°C
$P_{tot}$	total power dissipation	$T_{amb} = -40$ °C to +125 °C	[2] -	250	mW

[1] The input and output voltage ratings may be exceeded if the input and output current ratings are observed.

[2] For both TSSOP5 and SC-74A packages: above 87.5 °C the value of  $P_{tot}$  derates linearly with 4.0 mW/K.

## 9. Recommended operating conditions

**Table 6. Recommended operating conditions**

Voltages are referenced to GND (ground = 0 V).

Symbol	Parameter	Conditions	Min	Typ	Max	Unit
$V_{CC}$	supply voltage		2.0	5.0	5.5	V
$V_I$	input voltage		0	-	5.5	V
$V_O$	output voltage		0	-	$V_{CC}$	V
$T_{amb}$	ambient temperature		-40	+25	+125	°C
$\Delta t/\Delta V$	input transition rise and fall rate	$V_{CC} = 3.3$ V $\pm 0.3$ V	-	-	100	ns/V
		$V_{CC} = 5.0$ V $\pm 0.5$ V	-	-	20	ns/V

## 10. Static characteristics

**Table 7. Static characteristics**

Voltages are referenced to GND (ground = 0 V).

Symbol	Parameter	Conditions	25 °C			-40 °C to +85 °C		-40 °C to +125 °C		Unit
			Min	Typ	Max	Min	Max	Min	Max	
$V_{IH}$	HIGH-level input voltage	$V_{CC} = 2.0$ V	1.7	-	-	1.7	-	1.7	-	V
		$V_{CC} = 3.0$ V	2.4	-	-	2.4	-	2.4	-	V
		$V_{CC} = 5.5$ V	4.4	-	-	4.4	-	4.4	-	V
$V_{IL}$	LOW-level input voltage	$V_{CC} = 2.0$ V	-	-	0.3	-	0.3	-	0.3	V
		$V_{CC} = 3.0$ V	-	-	0.6	-	0.6	-	0.6	V
		$V_{CC} = 5.5$ V	-	-	1.1	-	1.1	-	1.1	V

**Table 7. Static characteristics ...continued**  
 Voltages are referenced to GND (ground = 0 V).

Symbol	Parameter	Conditions	25 °C			-40 °C to +85 °C		-40 °C to +125 °C		Unit
			Min	Typ	Max	Min	Max	Min	Max	
V <sub>OH</sub>	HIGH-level output voltage	V <sub>I</sub> = V <sub>IH</sub> or V <sub>IL</sub>								
		I <sub>O</sub> = -50 μA; V <sub>CC</sub> = 2.0 V	1.9	2.0	-	1.9	-	1.9	-	V
		I <sub>O</sub> = -50 μA; V <sub>CC</sub> = 3.0 V	2.9	3.0	-	2.9	-	2.9	-	V
		I <sub>O</sub> = -50 μA; V <sub>CC</sub> = 4.5 V	4.4	4.5	-	4.4	-	4.4	-	V
		I <sub>O</sub> = -4.0 mA; V <sub>CC</sub> = 3.0 V	2.58	-	-	2.48	-	2.40	-	V
		I <sub>O</sub> = -8.0 mA; V <sub>CC</sub> = 4.5 V	3.94	-	-	3.8	-	3.70	-	V
V <sub>OL</sub>	LOW-level output voltage	V <sub>I</sub> = V <sub>IH</sub> or V <sub>IL</sub>								
		I <sub>O</sub> = 50 μA; V <sub>CC</sub> = 2.0 V	-	0	0.1	-	0.1	-	0.1	V
		I <sub>O</sub> = 50 μA; V <sub>CC</sub> = 3.0 V	-	0	0.1	-	0.1	-	0.1	V
		I <sub>O</sub> = 50 μA; V <sub>CC</sub> = 4.5 V	-	0	0.1	-	0.1	-	0.1	V
		I <sub>O</sub> = 4.0 mA; V <sub>CC</sub> = 3.0 V	-	-	0.36	-	0.44	-	0.55	V
		I <sub>O</sub> = 8.0 mA; V <sub>CC</sub> = 4.5 V	-	-	0.36	-	0.44	-	0.55	V
I <sub>I</sub>	input leakage current	V <sub>I</sub> = 5.5 V or GND; V <sub>CC</sub> = 0 V to 5.5 V	-	-	0.1	-	1.0	-	2.0	μA
I <sub>CC</sub>	supply current	V <sub>I</sub> = V <sub>CC</sub> or GND; I <sub>O</sub> = 0 A; V <sub>CC</sub> = 5.5 V	-	-	1.0	-	10	-	40	μA
C <sub>I</sub>	input capacitance		-	1.5	10	-	10	-	10	pF

## 11. Dynamic characteristics

**Table 8. Dynamic characteristics**  
 GND = 0 V; t<sub>r</sub> = t<sub>f</sub> = ≤ 3.0 ns. For test circuit see [Figure 6](#).

Symbol	Parameter	Conditions	25 °C			-40 °C to +85 °C		-40 °C to +125 °C		Unit
			Min	Typ	Max	Min	Max	Min	Max	
t <sub>pd</sub>	propagation delay	A to Y; see <a href="#">Figure 5</a> <a href="#">[1]</a>								
		V <sub>CC</sub> = 3.0 V to 3.6 V <a href="#">[2]</a>								
		C <sub>L</sub> = 15 pF	-	3.4	7.1	1.0	8.5	1.0	10.0	ns
		C <sub>L</sub> = 50 pF	-	4.9	10.6	1.0	12.0	1.0	13.5	ns
		V <sub>CC</sub> = 4.5 V to 5.5 V <a href="#">[3]</a>								
		C <sub>L</sub> = 15 pF	-	2.6	5.5	1.0	6.0	1.0	7.0	ns
		C <sub>L</sub> = 50 pF	-	3.6	7.0	1.0	8.0	1.0	9.0	ns
C <sub>PD</sub>	power dissipation capacitance	per buffer; V <sub>I</sub> = GND to V <sub>CC</sub> <a href="#">[4]</a>	-	14	-	-	-	-	-	pF

- [1] t<sub>pd</sub> is the same as t<sub>PLH</sub> and t<sub>PHL</sub>.
- [2] Typical values are measured at V<sub>CC</sub> = 3.3 V.
- [3] Typical values are measured at V<sub>CC</sub> = 5.0 V.
- [4] C<sub>PD</sub> is used to determine the dynamic power dissipation P<sub>D</sub> (μW).  
 $P_D = C_{PD} \times V_{CC}^2 \times f_i + \sum (C_L \times V_{CC}^2 \times f_o)$  where:  
 f<sub>i</sub> = input frequency in MHz;

$f_o$  = output frequency in MHz;  
 $C_L$  = output load capacitance in pF;  
 $V_{CC}$  = supply voltage in Volts.

## 12. Waveforms

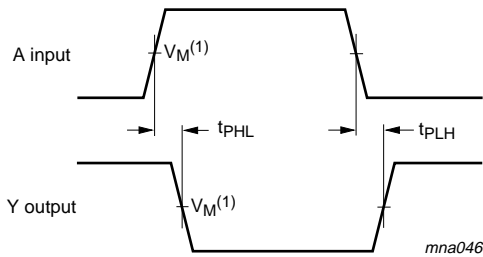

$V_M = 0.5 \times V_{CC}$ ;  $V_I = \text{GND to } V_{CC}$ .

Fig 5. The input (A) to output (Y) propagation delay times

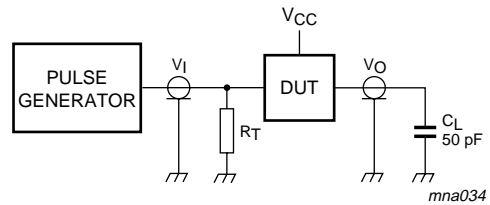

Test data is given in [Table 8](#).

Definitions for test circuit:

$C_L$  = Load capacitance including jig and probe capacitance.

$R_T$  = Termination resistance should be equal to output impedance  $Z_o$  of the pulse generator.

Fig 6. Load circuitry for switching times

## 13. Typical transfer characteristics

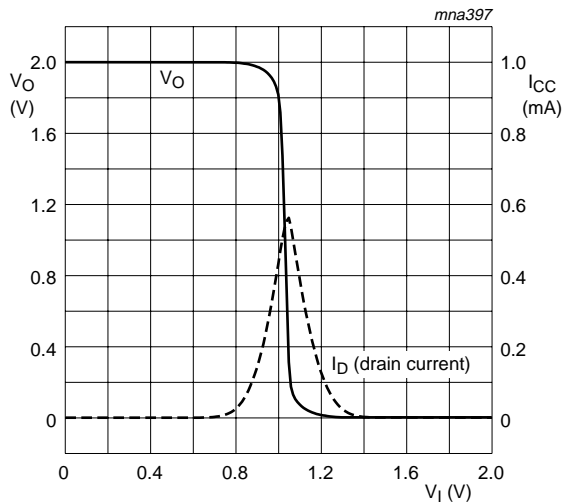

Fig 7.  $V_{CC} = 2.0 \text{ V}$ ;  $I_o = 0 \text{ A}$

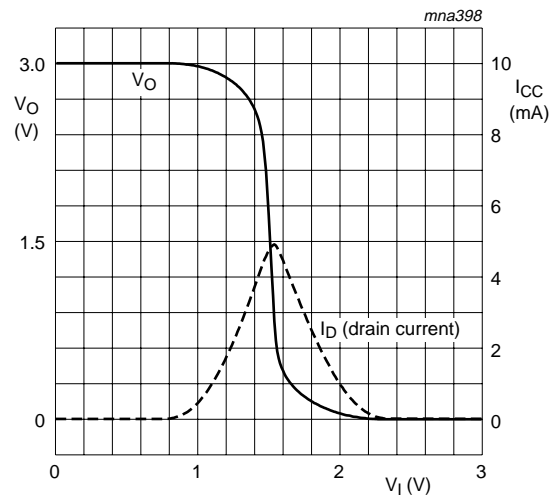

Fig 8.  $V_{CC} = 3.0 \text{ V}$ ;  $I_o = 0 \text{ A}$

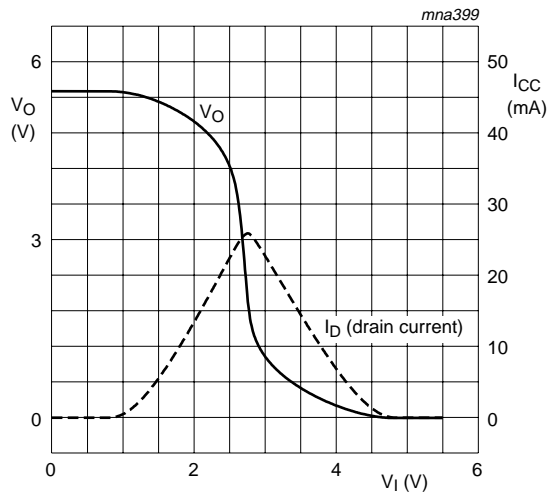

Fig 9.  $V_{CC} = 5.5\text{ V}; I_O = 0\text{ A}$

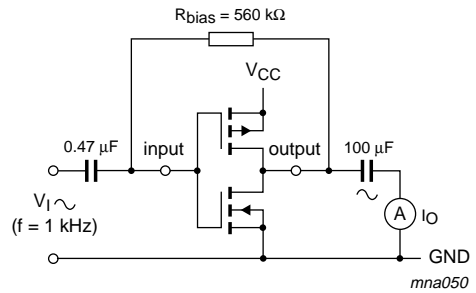

Fig 10. Test set-up for measuring forward transconductance  $g_{fs} = \Delta I_O / \Delta V_I$  at  $V_O$  is constant

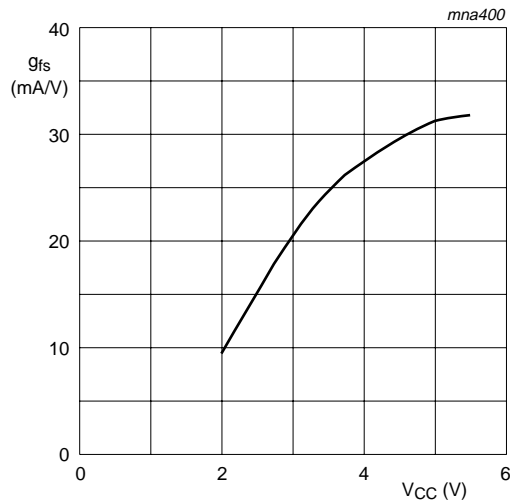

Fig 11. Typical forward transconductance  $g_{fs}$  as a function of the supply voltage at  $T_{amb} = 25\text{ }^\circ\text{C}$

## 14. Application information

Some applications are:

- Linear amplifier (see [Figure 12](#))
- In crystal oscillator design (see [Figure 13](#))

**Remark:** All values given are typical unless otherwise specified.

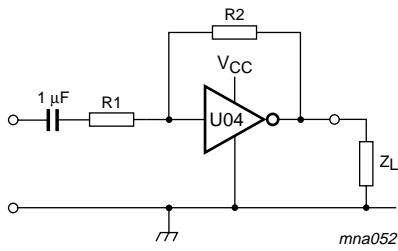

Maximum  $V_{o(p-p)} = V_{CC} - 1.5 \text{ V}$  centered at  $0.5 \times V_{CC}$ .

$$G_v = -\frac{G_{ol}}{1 + \frac{R1}{R2}(1 + G_{ol})}$$

$G_{ol}$  = open loop gain

$G_v$  = voltage gain

$R1 \geq 3 \text{ k}\Omega$ ,  $R2 \leq 1 \text{ M}\Omega$

$Z_L > 10 \text{ k}\Omega$ ;  $G_{ol} = 20$  (typ.)

Typical unity gain bandwidth product is 5 MHz.

Fig 12. Used as a linear amplifier

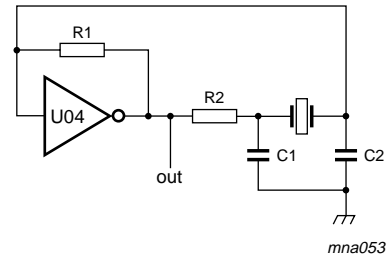

$C1 = 47 \text{ pF}$  (typ.)

$C2 = 22 \text{ pF}$  (typ.)

$R1 = 1 \text{ M}\Omega$  to  $10 \text{ M}\Omega$  (typ.)

$R2$  optimum value depends on the frequency and required stability against changes in  $V_{CC}$  or average minimum  $I_{CC}$  ( $I_{CC}$  is typically 2 mA at  $V_{CC} = 3 \text{ V}$  and  $f = 1 \text{ MHz}$ ).

Fig 13. Crystal oscillator configuration

Table 9. External components for resonator ( $f < 1 \text{ MHz}$ )

All values given are typical and must be used as an initial set-up.

Frequency	R1	R2	C1	C2
10 kHz to 15.9 kHz	22 M $\Omega$	220 k $\Omega$	56 pF	20 pF
16 kHz to 24.9 kHz	22 M $\Omega$	220 k $\Omega$	56 pF	10 pF
25 kHz to 54.9 kHz	22 M $\Omega$	100 k $\Omega$	56 pF	10 pF
55 kHz to 129.9 kHz	22 M $\Omega$	100 k $\Omega$	47 pF	5 pF
130 kHz to 199.9 kHz	22 M $\Omega$	47 k $\Omega$	47 pF	5 pF
200 kHz to 349.9 kHz	22 M $\Omega$	47 k $\Omega$	47 pF	5 pF
350 kHz to 600 kHz	22 M $\Omega$	47 k $\Omega$	47 pF	5 pF

Table 10. Optimum value for R2

Frequency	R2	Optimum for
3 kHz	2.0 k $\Omega$	minimum required $I_{CC}$
	8.0 k $\Omega$	minimum influence due to change in $V_{CC}$
6 kHz	1.0 k $\Omega$	minimum required $I_{CC}$
	4.7 k $\Omega$	minimum influence by $V_{CC}$
10 kHz	0.5 k $\Omega$	minimum required $I_{CC}$
	2.0 k $\Omega$	minimum influence by $V_{CC}$
14 kHz	0.5 k $\Omega$	minimum required $I_{CC}$
	1.0 k $\Omega$	minimum influence by $V_{CC}$
>14 kHz	-	replace R2 by C3 with a typical value of 35 pF

15. Package outline

TSSOP5: plastic thin shrink small outline package; 5 leads; body width 1.25 mm

SOT353-1



Fig 14. Package outline SOT353-1 (TSSOP5)



Plastic surface-mounted package; 5 leads

SOT753



Fig 15. Package outline SOT753 (SC-74A)

## 16. Abbreviations

Table 11. Abbreviations

Acronym	Description
CDM	Charged Device Model
DUT	Device Under Test
ESD	ElectroStatic Discharge
HBM	Human Body Model
MM	Machine Model

## 17. Revision history

Table 12. Revision history

Document ID	Release date	Data sheet status	Change notice	Supersedes
74AHC1GU04_5	20070710	Product data sheet	-	74AHC1GU04_4
Modifications:		<ul style="list-style-type: none"> <li>The format of this data sheet has been redesigned to comply with the new identity guidelines of NXP Semiconductors.</li> <li>Legal texts have been adapted to the new company name where appropriate.</li> <li>Package SOT353 changed to SOT353-1 in <a href="#">Section 3</a> and <a href="#">Section 15</a>.</li> <li>Quick reference data and Soldering sections removed.</li> </ul>		
74AHC1GU04_4	20020528	Product specification	-	74AHC1GU04_3
74AHC1GU04_3	20020215	Product specification	-	74AHC1GU04_2
74AHC1GU04_2	20010427	Product specification	-	74AHC1GU04_1
74AHC1GU04_1	19990519	Product specification	-	-

## 18. Legal information

### 18.1 Data sheet status

Document status <sup>[1][2]</sup>	Product status <sup>[3]</sup>	Definition
Objective [short] data sheet	Development	This document contains data from the objective specification for product development.
Preliminary [short] data sheet	Qualification	This document contains data from the preliminary specification.
Product [short] data sheet	Production	This document contains the product specification.

[1] Please consult the most recently issued document before initiating or completing a design.

[2] The term 'short data sheet' is explained in section "Definitions".

[3] The product status of device(s) described in this document may have changed since this document was published and may differ in case of multiple devices. The latest product status information is available on the Internet at URL <http://www.nxp.com>.

### 18.2 Definitions

**Draft** — The document is a draft version only. The content is still under internal review and subject to formal approval, which may result in modifications or additions. NXP Semiconductors does not give any representations or warranties as to the accuracy or completeness of information included herein and shall have no liability for the consequences of use of such information.

**Short data sheet** — A short data sheet is an extract from a full data sheet with the same product type number(s) and title. A short data sheet is intended for quick reference only and should not be relied upon to contain detailed and full information. For detailed and full information see the relevant full data sheet, which is available on request via the local NXP Semiconductors sales office. In case of any inconsistency or conflict with the short data sheet, the full data sheet shall prevail.

### 18.3 Disclaimers

**General** — Information in this document is believed to be accurate and reliable. However, NXP Semiconductors does not give any representations or warranties, expressed or implied, as to the accuracy or completeness of such information and shall have no liability for the consequences of use of such information.

**Right to make changes** — NXP Semiconductors reserves the right to make changes to information published in this document, including without limitation specifications and product descriptions, at any time and without notice. This document supersedes and replaces all information supplied prior to the publication hereof.

**Suitability for use** — NXP Semiconductors products are not designed, authorized or warranted to be suitable for use in medical, military, aircraft, space or life support equipment, nor in applications where failure or

malfunction of a NXP Semiconductors product can reasonably be expected to result in personal injury, death or severe property or environmental damage. NXP Semiconductors accepts no liability for inclusion and/or use of NXP Semiconductors products in such equipment or applications and therefore such inclusion and/or use is at the customer's own risk.

**Applications** — Applications that are described herein for any of these products are for illustrative purposes only. NXP Semiconductors makes no representation or warranty that such applications will be suitable for the specified use without further testing or modification.

**Limiting values** — Stress above one or more limiting values (as defined in the Absolute Maximum Ratings System of IEC 60134) may cause permanent damage to the device. Limiting values are stress ratings only and operation of the device at these or any other conditions above those given in the Characteristics sections of this document is not implied. Exposure to limiting values for extended periods may affect device reliability.

**Terms and conditions of sale** — NXP Semiconductors products are sold subject to the general terms and conditions of commercial sale, as published at <http://www.nxp.com/profile/terms>, including those pertaining to warranty, intellectual property rights infringement and limitation of liability, unless explicitly otherwise agreed to in writing by NXP Semiconductors. In case of any inconsistency or conflict between information in this document and such terms and conditions, the latter will prevail.

**No offer to sell or license** — Nothing in this document may be interpreted or construed as an offer to sell products that is open for acceptance or the grant, conveyance or implication of any license under any copyrights, patents or other industrial or intellectual property rights.

### 18.4 Trademarks

Notice: All referenced brands, product names, service names and trademarks are the property of their respective owners.

## 19. Contact information

For additional information, please visit: <http://www.nxp.com>

For sales office addresses, send an email to: [salesaddresses@nxp.com](mailto:salesaddresses@nxp.com)

20. Contents

1 General description . . . . . 1

2 Features . . . . . 1

3 Ordering information . . . . . 1

4 Marking . . . . . 1

5 Functional diagram . . . . . 2

6 Pinning information . . . . . 2

6.1 Pinning . . . . . 2

6.2 Pin description . . . . . 2

7 Functional description . . . . . 2

8 Limiting values . . . . . 3

9 Recommended operating conditions . . . . . 3

10 Static characteristics . . . . . 3

11 Dynamic characteristics . . . . . 4

12 Waveforms . . . . . 5

13 Typical transfer characteristics . . . . . 5

14 Application information . . . . . 6

15 Package outline . . . . . 8

16 Abbreviations . . . . . 10

17 Revision history . . . . . 10

18 Legal information . . . . . 11

18.1 Data sheet status . . . . . 11

18.2 Definitions . . . . . 11

18.3 Disclaimers . . . . . 11

18.4 Trademarks . . . . . 11

19 Contact information . . . . . 11

20 Contents . . . . . 12

Please be aware that important notices concerning this document and the product(s) described herein, have been included in section 'Legal information'.



# Mouser Electronics

Authorized Distributor

Click to View Pricing, Inventory, Delivery & Lifecycle Information:

[NXP:](#)

[74AHC1GU04GV](#) [74AHC1GU04GW-G](#) [74AHC1GU04GW-R](#) [74AHC1GU04GV,125](#) [74AHC1GU04GW,125](#)