

LM2937 500 mA Low Dropout Regulator

Check for Samples: [LM2937](#)

FEATURES

- Fully Specified for Operation Over -40°C to $+125^{\circ}\text{C}$
- Output Current in Excess of 500 mA
- Output Trimmed for 5% Tolerance Under all Operating Conditions
- Typical Dropout Voltage of 0.5V at Full Rated Load Current
- Wide Output Capacitor ESR Range, up to 3Ω
- Internal Short Circuit and Thermal Overload Protection
- Reverse Battery Protection
- 60V Input Transient Protection
- Mirror Image Insertion Protection

DESCRIPTION

The LM2937 is a positive voltage regulator capable of supplying up to 500 mA of load current. The use of a PNP power transistor provides a low dropout voltage characteristic. With a load current of 500 mA the minimum input to output voltage differential required for the output to remain in regulation is typically 0.5V (1V ensured maximum over the full operating temperature range). Special circuitry has been incorporated to minimize the quiescent current to typically only 10 mA with a full 500 mA load current when the input to output voltage differential is greater than 3V.

The LM2937 requires an output bypass capacitor for stability. As with most low dropout regulators, the ESR of this capacitor remains a critical design parameter, but the LM2937 includes special compensation circuitry that relaxes ESR requirements. The LM2937 is stable for all ESR below 3Ω . This allows the use of low ESR chip capacitors.

Ideally suited for automotive applications, the LM2937 will protect itself and any load circuitry from reverse battery connections, two-battery jumps and up to +60V/-50V load dump transients. Familiar regulator features such as short circuit and thermal shutdown protection are also built in.

Connection Diagrams

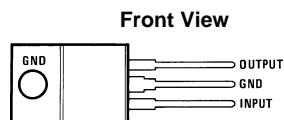

Figure 1. TO-220 Plastic Package
See Package Number NDE0003B

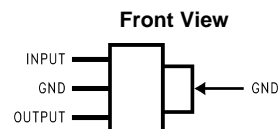

Figure 2. SOT-223 Plastic Package
See Package Number DCY0004A

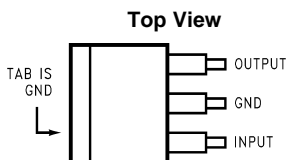

Figure 3. DPAK/TO-263 Surface-Mount Package
See Package Number KTT0003B

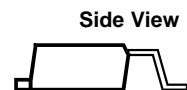

Figure 4. DPAK/TO-263 Surface-Mount Package
See Package Number KTT0003B



Please be aware that an important notice concerning availability, standard warranty, and use in critical applications of Texas Instruments semiconductor products and disclaimers thereto appears at the end of this data sheet.

All trademarks are the property of their respective owners.



These devices have limited built-in ESD protection. The leads should be shorted together or the device placed in conductive foam during storage or handling to prevent electrostatic damage to the MOS gates.

Absolute Maximum Ratings⁽¹⁾⁽²⁾

Input Voltage	Continuous	26V
	Transient (t ≤ 100 ms)	60V
Internal Power Dissipation ⁽³⁾	Internally Limited	
Maximum Junction Temperature	150°C	
Storage Temperature Range	-65°C to +150°C	
TO-220 (10 seconds)	260°C	
DDPAK/TO-263 (10 seconds)	230°C	
SOT-223 (Vapor Phase, 60 seconds)	215°C	
SOT-223 (Infared, 15 seconds)	220°C	
ESD Susceptibility ⁽⁴⁾	2 kV	

- (1) Absolute Maximum Ratings indicate limits beyond which damage to the device may occur. Electrical specifications do not apply when operating the device outside of its rated Operating Conditions.
- (2) If Military/Aerospace specified devices are required, please contact the Texas Instruments Sales Office/Distributors for availability and specifications.
- (3) The maximum allowable power dissipation at any ambient temperature is $P_{MAX} = (125 - T_A)/\theta_{JA}$, where 125 is the maximum junction temperature for operation, T_A is the ambient temperature, and θ_{JA} is the junction-to-ambient thermal resistance. If this dissipation is exceeded, the die temperature will rise above 125°C and the electrical specifications do not apply. If the die temperature rises above 150°C, the LM2937 will go into thermal shutdown. For the LM2937, the junction-to-ambient thermal resistance θ_{JA} is 65°C/W, for the TO-220 package, 73°C/W for the DDPAK/TO-263 package, and 174°C/W for the SOT-223 package. When used with a heatsink, θ_{JA} is the sum of the LM2937 junction-to-case thermal resistance θ_{JC} of 3°C/W and the heatsink case-to-ambient thermal resistance. If the DDPAK/TO-263 or SOT-223 packages are used, the thermal resistance can be reduced by increasing the P.C. board copper area thermally connected to the package (see [Application Hints](#) for more information on heatsinking).
- (4) ESD rating is based on the human body model, 100 pF discharged through 1.5 kΩ.

Operating Conditions⁽¹⁾

Temperature Range ⁽²⁾	LM2937ET, LM2937ES	-40°C ≤ T _J ≤ 125°C
	LM2937IMP	-40°C ≤ T _J ≤ 85°C
Maximum Input Voltage	26V	

- (1) Absolute Maximum Ratings indicate limits beyond which damage to the device may occur. Electrical specifications do not apply when operating the device outside of its rated Operating Conditions.
- (2) The maximum allowable power dissipation at any ambient temperature is $P_{MAX} = (125 - T_A)/\theta_{JA}$, where 125 is the maximum junction temperature for operation, T_A is the ambient temperature, and θ_{JA} is the junction-to-ambient thermal resistance. If this dissipation is exceeded, the die temperature will rise above 125°C and the electrical specifications do not apply. If the die temperature rises above 150°C, the LM2937 will go into thermal shutdown. For the LM2937, the junction-to-ambient thermal resistance θ_{JA} is 65°C/W, for the TO-220 package, 73°C/W for the DDPAK/TO-263 package, and 174°C/W for the SOT-223 package. When used with a heatsink, θ_{JA} is the sum of the LM2937 junction-to-case thermal resistance θ_{JC} of 3°C/W and the heatsink case-to-ambient thermal resistance. If the DDPAK/TO-263 or SOT-223 packages are used, the thermal resistance can be reduced by increasing the P.C. board copper area thermally connected to the package (see [Application Hints](#) for more information on heatsinking).

Electrical Characteristics

$V_{IN} = V_{NOM} + 5V^{(1)}$ $I_{OUTmax} = 500\text{ mA}$ for the TO-220 and DDPAK/TO-263 packages, $I_{OUTmax} = 400\text{ mA}$ for the SOT-223 package, $C_{OUT} = 10\text{ }\mu\text{F}$ unless otherwise indicated. **Boldface limits apply over the entire operating temperature range of the indicated device.**, all other specifications are for $T_A = T_J = 25^\circ\text{C}$.

Output Voltage (V_{OUT})		5V		8V		10V		Units
Parameter	Conditions	Typ	Limit	Typ	Limit	Typ	Limit	
Output Voltage	$5\text{ mA} \leq I_{OUT} \leq I_{OUTmax}$	5.00	4.85	8.00	7.76	10.00	9.70	V(Min)
			4.75		7.60		9.50	V(Min)
			5.15		8.24		10.30	V(Max)
			5.25		8.40		10.50	V(Max)
Line Regulation	$(V_{OUT} + 2V) \leq V_{IN} \leq 26V$, $I_{OUT} = 5\text{ mA}$	15	50	24	80	30	100	mV(Max)
Load Regulation	$5\text{ mA} \leq I_{OUT} \leq I_{OUTmax}$	5	50	8	80	10	100	mV(Max)
Quiescent Current	$(V_{OUT} + 2V) \leq V_{IN} \leq 26V$, $I_{OUT} = 5\text{ mA}$	2	10	2	10	2	10	mA(Max)
	$V_{IN} = (V_{OUT} + 5V)$, $I_{OUT} = I_{OUTmax}$	10	20	10	20	10	20	mA(Max)
Output Noise Voltage	10 Hz–100 kHz, $I_{OUT} = 5\text{ mA}$	150		240		300		μVrms
Long Term Stability	1000 Hrs.	20		32		40		mV
Dropout Voltage	$I_{OUT} = I_{OUTmax}$	0.5	1.0	0.5	1.0	0.5	1.0	V(Max)
	$I_{OUT} = 50\text{ mA}$	110	250	110	250	110	250	mV(Max)
Short-Circuit Current		1.0	0.6	1.0	0.6	1.0	0.6	A(Min)
Peak Line Transient Voltage	$t_f < 100\text{ ms}$, $R_L = 100\Omega$	75	60	75	60	75	60	V(Min)
Maximum Operational Input Voltage			26		26		26	V(Min)
Reverse DC Input Voltage	$V_{OUT} \geq -0.6V$, $R_L = 100\Omega$	-30	-15	-30	-15	-30	-15	V(Min)
Reverse Transient Input Voltage	$t_r < 1\text{ ms}$, $R_L = 100\Omega$	-75	-50	-75	-50	-75	-50	V(Min)

(1) Typicals are at $T_J = 25^\circ\text{C}$ and represent the most likely parametric norm.

Electrical Characteristics

$V_{IN} = V_{NOM} + 5V^{(1)}$ $I_{OUTmax} = 500\text{ mA}$ for the TO-220 and DDPAK/TO-263 packages, $I_{OUTmax} = 400\text{ mA}$ for the SOT-223 package, $C_{OUT} = 10\text{ }\mu\text{F}$ unless otherwise indicated. **Boldface limits apply over the entire operating temperature range of the indicted device.**, all other specifications are for $T_A = T_J = 25^\circ\text{C}$.

Output Voltage (V_{OUT})		12V		15V		Units
Parameter	Conditions	Typ	Limit	Typ	Limit	
Output Voltage	$5\text{ mA} \leq I_{OUT} \leq I_{OUTmax}$	12.00	11.64	15.00	14.55	V (Min)
			11.40		14.25	V(Min)
			12.36		15.45	V(Max)
			12.60		15.75	V(Max)
Line Regulation	$(V_{OUT} + 2V) \leq V_{IN} \leq 26V$, $I_{OUT} = 5\text{ mA}$	36	120	45	150	mV(Max)
Load Regulation	$5\text{ mA} \leq I_{OUT} \leq I_{OUTmax}$	12	120	15	150	mV(Max)
Quiescent Current	$(V_{OUT} + 2V) \leq V_{IN} \leq 26V$, $I_{OUT} = 5\text{ mA}$	2	10	2	10	mA(Max)
	$V_{IN} = (V_{OUT} + 5V)$, $I_{OUT} = I_{OUTmax}$	10	20	10	20	mA(Max)
Output Noise Voltage	10 Hz–100 kHz, $I_{OUT} = 5\text{ mA}$	360		450		μVrms
Long Term Stability	1000 Hrs	44		56		mV
Dropout Voltage	$I_{OUT} = I_{OUTmax}$	0.5	1.0	0.5	1.0	V(Max)
	$I_{OUT} = 50\text{ mA}$	110	250	110	250	mV(Max)
Short-Circuit Current		1.0	0.6	1.0	0.6	A(Min)
Peak Line Transient Voltage	$t_f < 100\text{ ms}$, $R_L = 100\Omega$	75	60	75	60	V(Min)
Maximum Operational Input Voltage			26		26	V(Min)
Reverse DC Input Voltage	$V_{OUT} \geq -0.6V$, $R_L = 100\Omega$	-30	-15	-30	-15	V(Min)
Reverse Transient Input Voltage	$t_f < 1\text{ ms}$, $R_L = 100\Omega$	-75	-50	-75	-50	V(Min)

(1) Typicals are at $T_J = 25^\circ\text{C}$ and represent the most likely parametric norm.

Typical Performance Characteristics

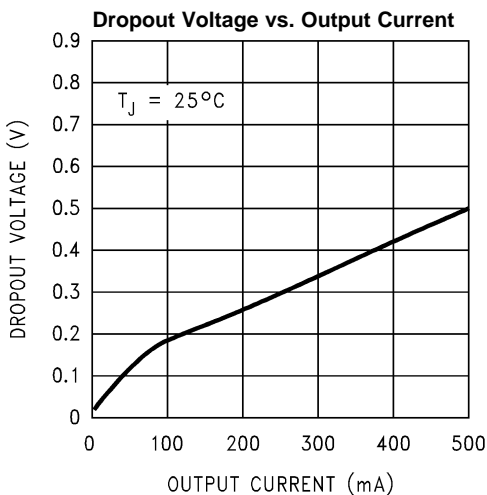

Figure 5.

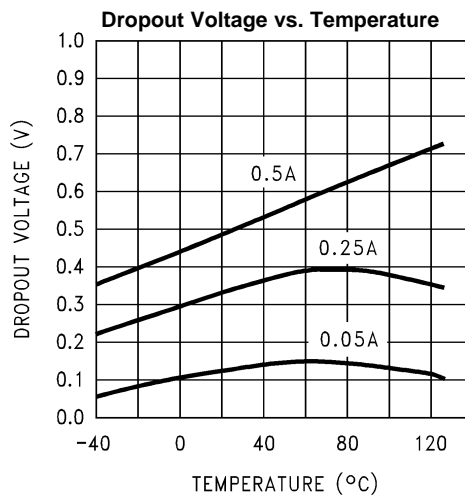

Figure 6.

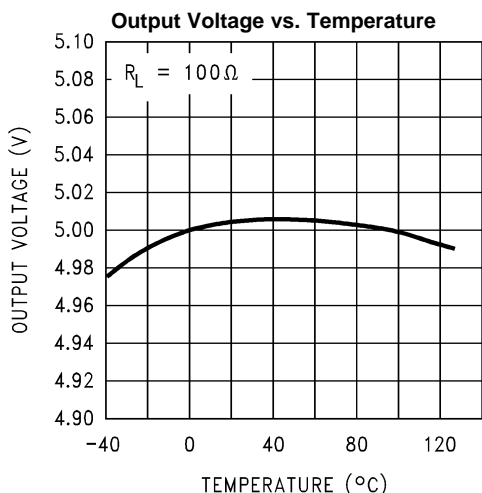

Figure 7.

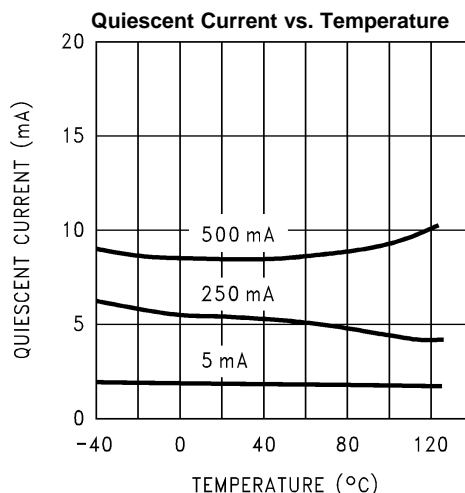

Figure 8.

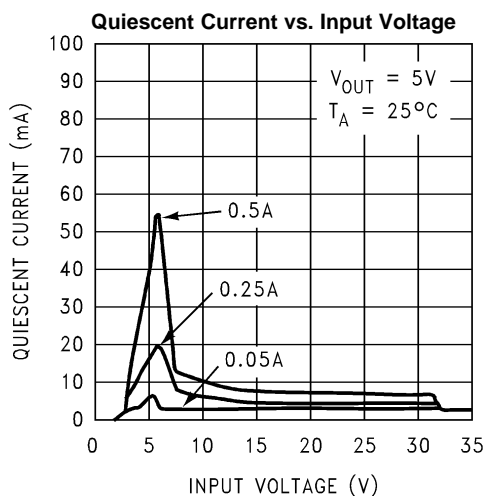

Figure 9.

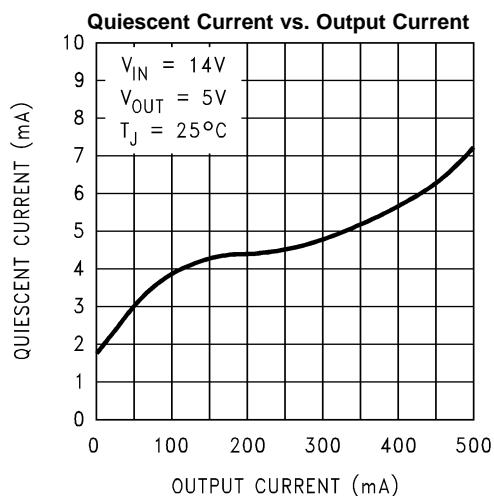

Figure 10.

Typical Performance Characteristics (continued)

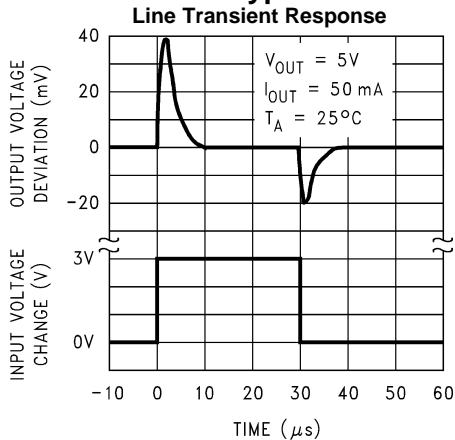

Figure 11.

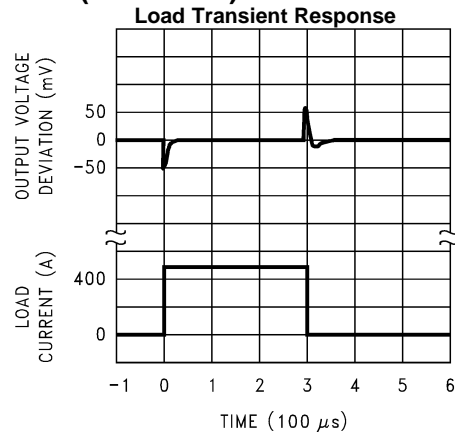

Figure 12.

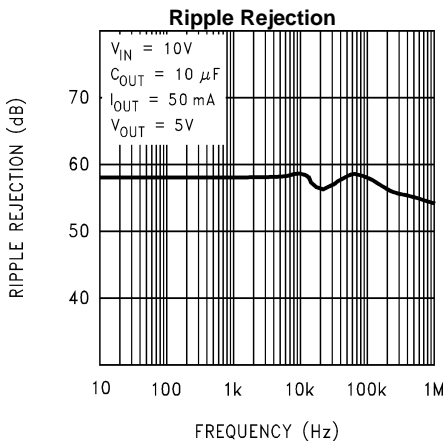

Figure 13.

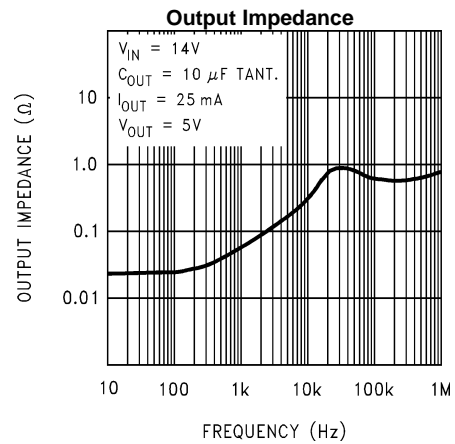

Figure 14.

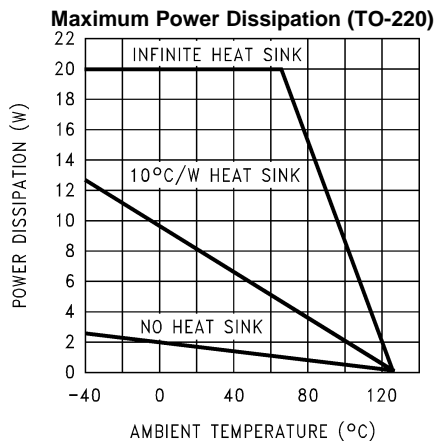

Figure 15.

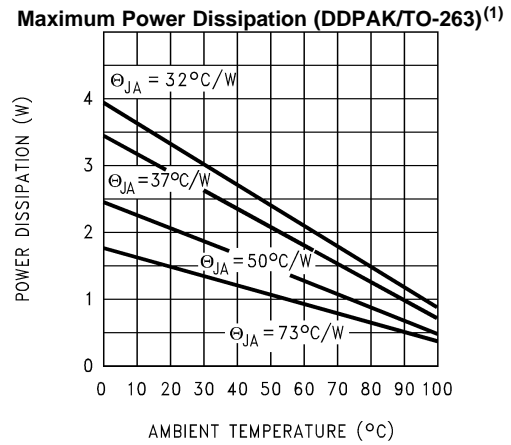

Figure 16.

(1) The maximum allowable power dissipation at any ambient temperature is $P_{MAX} = (125 - T_A)/\theta_{JA}$, where 125 is the maximum junction temperature for operation, T_A is the ambient temperature, and θ_{JA} is the junction-to-ambient thermal resistance. If this dissipation is exceeded, the die temperature will rise above 125 $^\circ C$ and the electrical specifications do not apply. If the die temperature rises above 150 $^\circ C$, the LM2937 will go into thermal shutdown. For the LM2937, the junction-to-ambient thermal resistance θ_{JA} is 65 $^\circ C/W$, for the TO-220 package, 73 $^\circ C/W$ for the DDPAK/TO-263 package, and 174 $^\circ C/W$ for the SOT-223 package. When used with a heatsink, θ_{JA} is the sum of the LM2937 junction-to-case thermal resistance θ_{JC} of 3 $^\circ C/W$ and the heatsink case-to-ambient thermal resistance. If the DDPAK/TO-263 or SOT-223 packages are used, the thermal resistance can be reduced by increasing the P.C. board copper area thermally connected to the package (see [Application Hints](#) for more information on heatsinking).

Typical Performance Characteristics (continued)

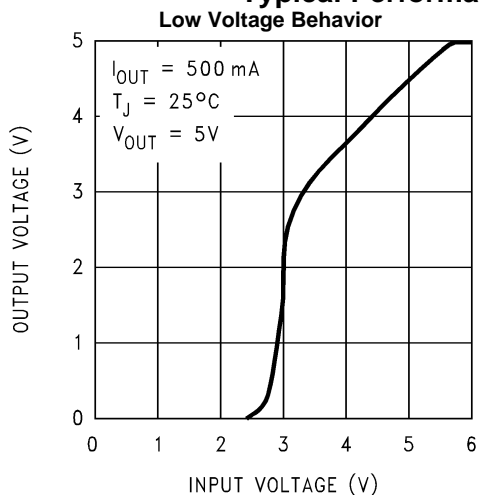

Figure 17.

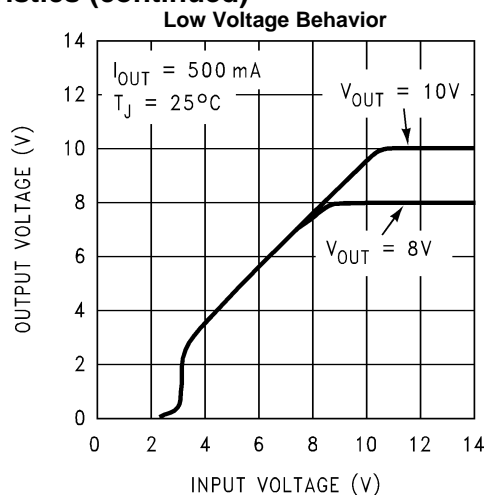

Figure 18.

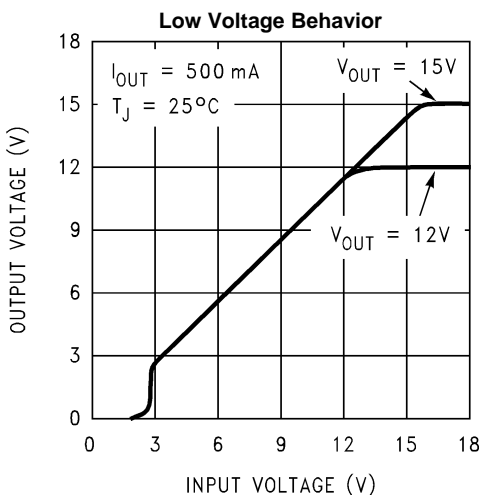

Figure 19.

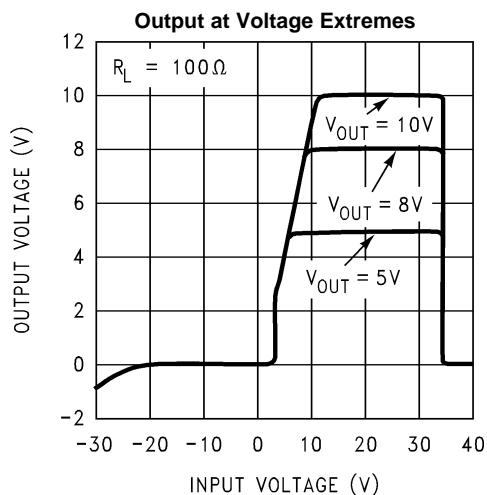

Figure 20.

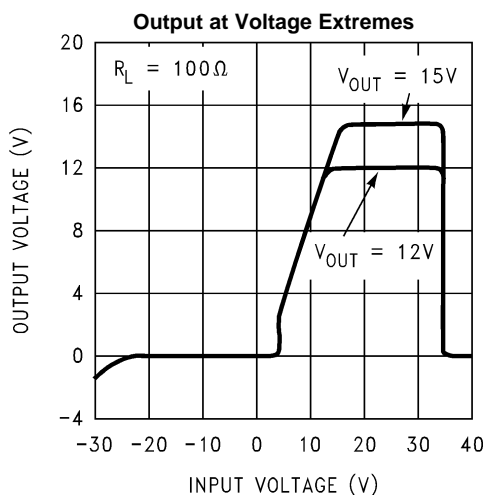

Figure 21.

Typical Performance Characteristics (continued)

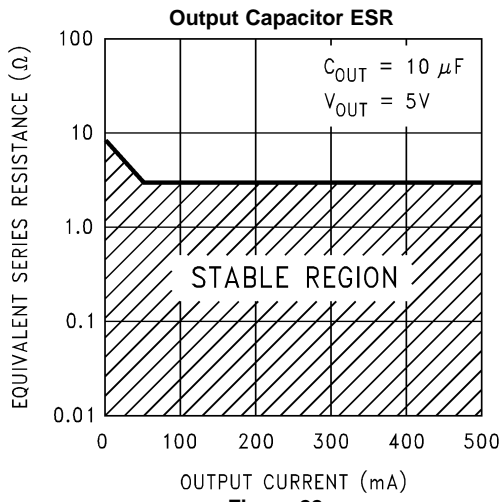

Figure 22.

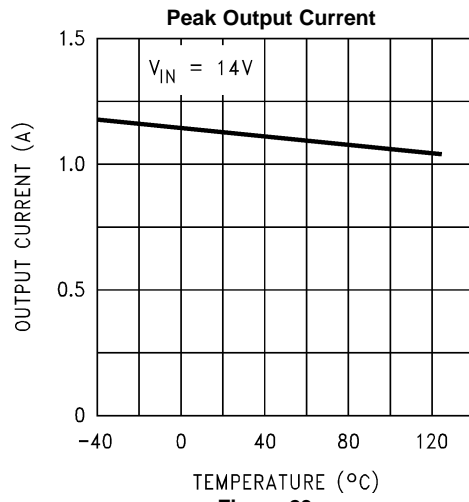
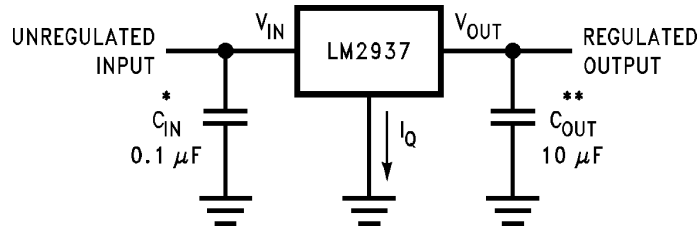

Figure 23.

Typical Application



* Required if the regulator is located more than 3 inches from the power supply filter capacitors.

** Required for stability. C_{out} must be at least 10 μF (over the full expected operating temperature range) and located as close as possible to the regulator. The equivalent series resistance, ESR, of this capacitor may be as high as 3 Ω .

APPLICATION HINTS

EXTERNAL CAPACITORS

The output capacitor is critical to maintaining regulator stability, and must meet the required conditions for both ESR (Equivalent Series Resistance) and minimum amount of capacitance.

MINIMUM CAPACITANCE:

The minimum output capacitance required to maintain stability is 10 μF (this value may be increased without limit). Larger values of output capacitance will give improved transient response.

ESR LIMITS:

The ESR of the output capacitor will cause loop instability if it is too high or too low. The acceptable range of ESR plotted versus load current is shown in the graph below. ***It is essential that the output capacitor meet these requirements, or oscillations can result.***

Output Capacitor ESR

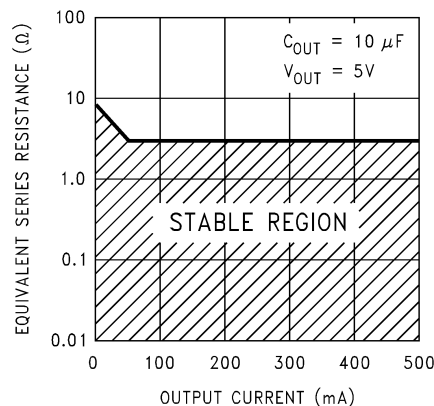

Figure 24. ESR Limits

It is important to note that for most capacitors, ESR is specified only at room temperature. However, the designer must ensure that the ESR will stay inside the limits shown over the entire operating temperature range for the design.

For aluminum electrolytic capacitors, ESR will increase by about 30X as the temperature is reduced from 25°C to -40°C. This type of capacitor is not well-suited for low temperature operation.

Solid tantalum capacitors have a more stable ESR over temperature, but are more expensive than aluminum electrolytics. A cost-effective approach sometimes used is to parallel an aluminum electrolytic with a solid Tantalum, with the total capacitance split about 75/25% with the Aluminum being the larger value.

If two capacitors are paralleled, the effective ESR is the parallel of the two individual values. The “flatter” ESR of the Tantalum will keep the effective ESR from rising as quickly at low temperatures.

HEATSINKING

A heatsink may be required depending on the maximum power dissipation and maximum ambient temperature of the application. Under all possible operating conditions, the junction temperature must be within the range specified under [Absolute Maximum Ratings](#).

To determine if a heatsink is required, the power dissipated by the regulator, P_D , must be calculated.

The figure below shows the voltages and currents which are present in the circuit, as well as the formula for calculating the power dissipated in the regulator:

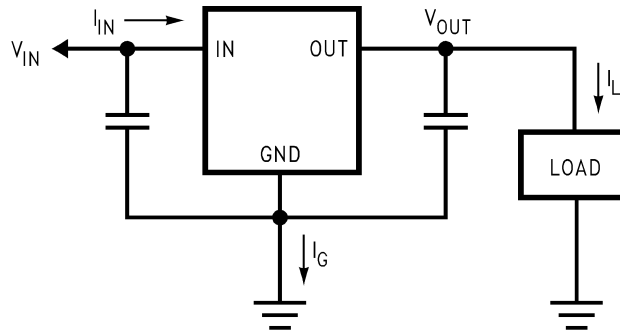

$$I_{IN} = I_L + I_G$$

$$P_D = (V_{IN} - V_{OUT}) I_L + (V_{IN}) I_G$$

Figure 25. Power Dissipation Diagram

The next parameter which must be calculated is the maximum allowable temperature rise, T_R (max). This is calculated by using the formula:

$$T_R \text{ (max)} = T_J \text{ (max)} - T_A \text{ (max)}$$

where

- T_J (max) is the maximum allowable junction temperature, which is 125°C for commercial grade parts
- T_A (max) is the maximum ambient temperature which will be encountered in the application (1)

Using the calculated values for T_R (max) and P_D , the maximum allowable value for the junction-to-ambient thermal resistance, $\theta_{(J-A)}$, can now be found:

$$\theta_{(J-A)} = T_R \text{ (max)}/P_D \quad (2)$$

IMPORTANT: If the maximum allowable value for $\theta_{(J-A)}$ is found to be $\geq 53^\circ\text{C}/\text{W}$ for the TO-220 package, $\geq 80^\circ\text{C}/\text{W}$ for the DPAK/TO-263 package, or $\geq 174^\circ\text{C}/\text{W}$ for the SOT-223 package, no heatsink is needed since the package alone will dissipate enough heat to satisfy these requirements.

If the calculated value for $\theta_{(J-A)}$ falls below these limits, a heatsink is required.

HEATSINKING TO-220 PACKAGE PARTS

The TO-220 can be attached to a typical heatsink, or secured to a copper plane on a PC board. If a copper plane is to be used, the values of $\theta_{(J-A)}$ will be the same as shown in the next section for the DDPAK/TO-263.

If a manufactured heatsink is to be selected, the value of heatsink-to-ambient thermal resistance, $\theta_{(H-A)}$, must first be calculated:

$$\theta_{(H-A)} = \theta_{(J-A)} - \theta_{(C-H)} - \theta_{(J-C)}$$

where

- $\theta_{(J-C)}$ is defined as the thermal resistance from the junction to the surface of the case. A value of 3°C/W can be assumed for $\theta_{(J-C)}$ for this calculation
- $\theta_{(C-H)}$ is defined as the thermal resistance between the case and the surface of the heatsink. The value of $\theta_{(C-H)}$ will vary from about 1.5°C/W to about 2.5°C/W (depending on method of attachment, insulator, etc.). If the exact value is unknown, 2°C/W should be assumed for $\theta_{(C-H)}$ (3)

When a value for $\theta_{(H-A)}$ is found using the equation shown, a heatsink must be selected that has a value that is less than or equal to this number.

$\theta_{(H-A)}$ is specified numerically by the heatsink manufacturer in the catalog, or shown in a curve that plots temperature rise vs power dissipation for the heatsink.

HEATSINKING DDPAK/TO-263 AND SOT-223 PACKAGE PARTS

Both the DDPAK/TO-263 (“S”) and SOT-223 (“MP”) packages use a copper plane on the PCB and the PCB itself as a heatsink. To optimize the heat sinking ability of the plane and PCB, solder the tab of the package to the plane.

Figure 26 shows for the DDPAK/TO-263 the measured values of $\theta_{(J-A)}$ for different copper area sizes using a typical PCB with 1 ounce copper and no solder mask over the copper area used for heatsinking.

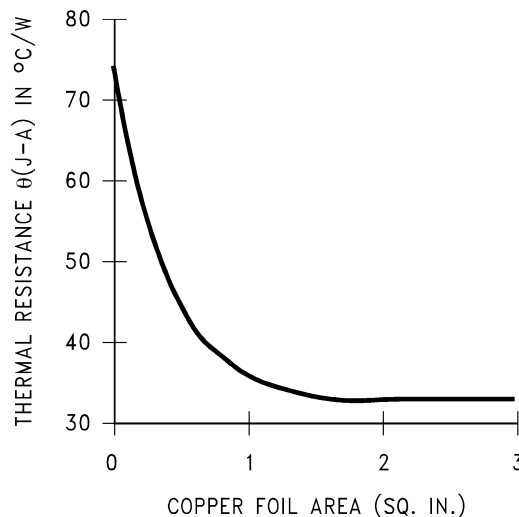

Figure 26. $\theta_{(J-A)}$ vs. Copper (1 ounce) Area for the DDPAK/TO-263 Package

As shown in the figure, increasing the copper area beyond 1 square inch produces very little improvement. It should also be observed that the minimum value of $\theta_{(J-A)}$ for the DDPAK/TO-263 package mounted to a PCB is 32°C/W.

As a design aid, Figure 27 shows the maximum allowable power dissipation compared to ambient temperature for the DDPAK/TO-263 device (assuming $\theta_{(J-A)}$ is 35°C/W and the maximum junction temperature is 125°C).

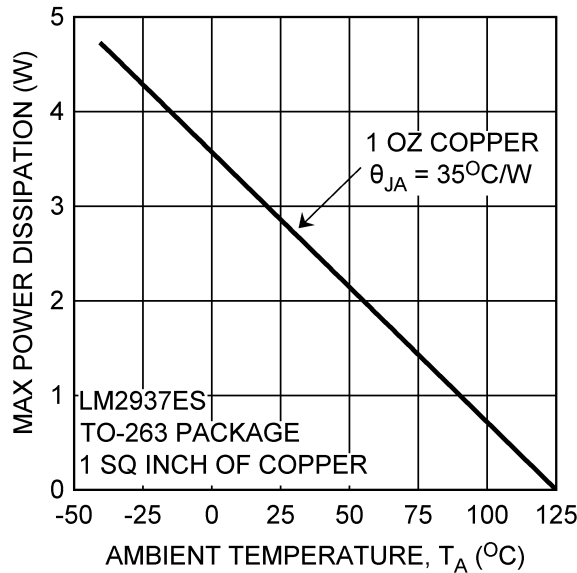

Figure 27. Maximum Power Dissipation vs. T_{AMB} for the DPAK/TO-263 Package

Figure 28 and Figure 29 show the information for the SOT-223 package. Figure 29 assumes a $\theta_{(J-A)}$ of 74°C/W for 1 ounce copper and 51°C/W for 2 ounce copper and a maximum junction temperature of +85°C.

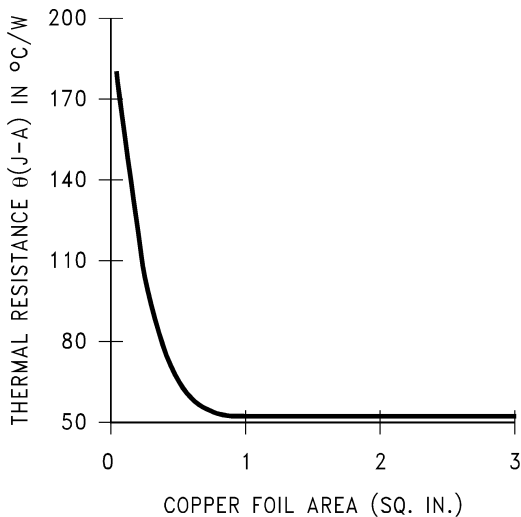

Figure 28. $\theta_{(J-A)}$ vs Copper (2 ounce) Area for the SOT-223 Package

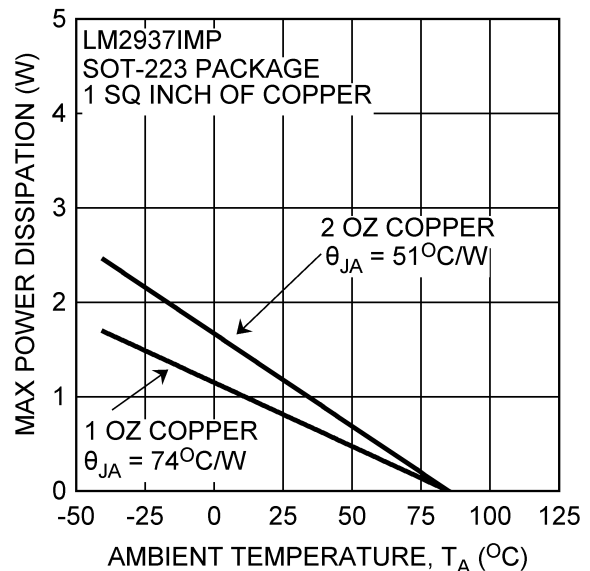

Figure 29. Maximum Power Dissipation vs T_{AMB} for the SOT-223 Package

SOT-223 SOLDERING RECOMMENDATIONS

It is not recommended to use hand soldering or wave soldering to attach the small SOT-223 package to a printed circuit board. The excessive temperatures involved may cause package cracking.

Either vapor phase or infrared reflow techniques are preferred soldering attachment methods for the SOT-223 package.

PACKAGING INFORMATION

Orderable Device	Status (1)	Package Type	Package Drawing	Pins	Package Qty	Eco Plan (2)	Lead/Ball Finish	MSL Peak Temp (3)	Op Temp (°C)	Top-Side Markings (4)	Samples
LM2937ES-10	ACTIVE	DDPAK/ TO-263	KTT	3	45	TBD	Call TI	Call TI	-40 to 125	LM2937ES -10	Samples
LM2937ES-10/NOPB	ACTIVE	DDPAK/ TO-263	KTT	3	45	Pb-Free (RoHS Exempt)	CU SN	Level-3-245C-168 HR	-40 to 125	LM2937ES -10	Samples
LM2937ES-12	ACTIVE	DDPAK/ TO-263	KTT	3	45	TBD	Call TI	Call TI	-40 to 125	LM2937ES -12	Samples
LM2937ES-12/NOPB	ACTIVE	DDPAK/ TO-263	KTT	3	45	Pb-Free (RoHS Exempt)	CU SN	Level-3-245C-168 HR	-40 to 125	LM2937ES -12	Samples
LM2937ES-15	ACTIVE	DDPAK/ TO-263	KTT	3	45	TBD	Call TI	Call TI	-40 to 125	LM2937ES -15	Samples
LM2937ES-15/NOPB	ACTIVE	DDPAK/ TO-263	KTT	3	45	Pb-Free (RoHS Exempt)	CU SN	Level-3-245C-168 HR	-40 to 125	LM2937ES -15	Samples
LM2937ES-5.0	ACTIVE	DDPAK/ TO-263	KTT	3	45	TBD	Call TI	Call TI	-40 to 125	LM2937ES -5.0	Samples
LM2937ES-5.0/NOPB	ACTIVE	DDPAK/ TO-263	KTT	3	45	Pb-Free (RoHS Exempt)	CU SN	Level-3-245C-168 HR	-40 to 125	LM2937ES -5.0	Samples
LM2937ES-8.0	ACTIVE	DDPAK/ TO-263	KTT	3	45	TBD	Call TI	Call TI	-40 to 125	LM2937ES -8.0	Samples
LM2937ES-8.0/NOPB	ACTIVE	DDPAK/ TO-263	KTT	3	45	Pb-Free (RoHS Exempt)	CU SN	Level-3-245C-168 HR	-40 to 125	LM2937ES -8.0	Samples
LM2937ESX-12	ACTIVE	DDPAK/ TO-263	KTT	3	500	TBD	Call TI	Call TI	-40 to 125	LM2937ES -12	Samples
LM2937ESX-12/NOPB	ACTIVE	DDPAK/ TO-263	KTT	3	500	Pb-Free (RoHS Exempt)	CU SN	Level-3-245C-168 HR	-40 to 125	LM2937ES -12	Samples
LM2937ESX-15	ACTIVE	DDPAK/ TO-263	KTT	3	500	TBD	Call TI	Call TI	-40 to 125	LM2937ES -15	Samples
LM2937ESX-15/NOPB	ACTIVE	DDPAK/ TO-263	KTT	3	500	Pb-Free (RoHS Exempt)	CU SN	Level-3-245C-168 HR	-40 to 125	LM2937ES -15	Samples
LM2937ESX-5.0	ACTIVE	DDPAK/ TO-263	KTT	3	500	TBD	Call TI	Call TI	-40 to 125	LM2937ES -5.0	Samples
LM2937ESX-5.0/NOPB	ACTIVE	DDPAK/ TO-263	KTT	3	500	Pb-Free (RoHS Exempt)	CU SN	Level-3-245C-168 HR	-40 to 125	LM2937ES -5.0	Samples
LM2937ESX-8.0	ACTIVE	DDPAK/ TO-263	KTT	3	500	TBD	Call TI	Call TI	-40 to 125	LM2937ES -8.0	Samples

Orderable Device	Status (1)	Package Type	Package Drawing	Pins	Package Qty	Eco Plan (2)	Lead/Ball Finish	MSL Peak Temp (3)	Op Temp (°C)	Top-Side Markings (4)	Samples
LM2937ESX-8.0/NOPB	ACTIVE	DDPAK/ TO-263	KTT	3	500	Pb-Free (RoHS Exempt)	CU SN	Level-3-245C-168 HR	-40 to 125	LM2937ES -8.0	Samples
LM2937ET-10	ACTIVE	TO-220	NDE	3	45	TBD	Call TI	Call TI	-40 to 125	LM2937ET -10	Samples
LM2937ET-10/NOPB	ACTIVE	TO-220	NDE	3	45	Green (RoHS & no Sb/Br)	CU SN	Level-1-NA-UNLIM	-40 to 125	LM2937ET -10	Samples
LM2937ET-12	ACTIVE	TO-220	NDE	3	45	TBD	Call TI	Call TI	-40 to 125	LM2937ET -12	Samples
LM2937ET-12/NOPB	ACTIVE	TO-220	NDE	3	45	Green (RoHS & no Sb/Br)	CU SN	Level-1-NA-UNLIM	-40 to 125	LM2937ET -12	Samples
LM2937ET-15	ACTIVE	TO-220	NDE	3	45	TBD	Call TI	Call TI	-40 to 125	LM2937ET -15	Samples
LM2937ET-15/NOPB	ACTIVE	TO-220	NDE	3	45	Green (RoHS & no Sb/Br)	CU SN	Level-1-NA-UNLIM	-40 to 125	LM2937ET -15	Samples
LM2937ET-5.0	ACTIVE	TO-220	NDE	3	45	TBD	Call TI	Call TI	-40 to 125	LM2937ET -5.0	Samples
LM2937ET-5.0/NOPB	ACTIVE	TO-220	NDE	3	45	Pb-Free (RoHS Exempt)	CU SN	Level-1-NA-UNLIM	-40 to 125	LM2937ET -5.0	Samples
LM2937ET-8.0	ACTIVE	TO-220	NDE	3	45	TBD	Call TI	Call TI	-40 to 125	LM2937ET -8.0	Samples
LM2937ET-8.0/NOPB	ACTIVE	TO-220	NDE	3	45	Green (RoHS & no Sb/Br)	CU SN	Level-1-NA-UNLIM	-40 to 125	LM2937ET -8.0	Samples
LM2937IMP-10	ACTIVE	SOT-223	DCY	4	1000	TBD	Call TI	Call TI	-40 to 125	L73B	Samples
LM2937IMP-10/NOPB	ACTIVE	SOT-223	DCY	4	1000	Green (RoHS & no Sb/Br)	CU SN	Level-1-260C-UNLIM	-40 to 125	L73B	Samples
LM2937IMP-12	ACTIVE	SOT-223	DCY	4	1000	TBD	Call TI	Call TI	-40 to 125	L74B	Samples
LM2937IMP-12/NOPB	ACTIVE	SOT-223	DCY	4	1000	Green (RoHS & no Sb/Br)	CU SN	Level-1-260C-UNLIM	-40 to 125	L74B	Samples
LM2937IMP-5.0	ACTIVE	SOT-223	DCY	4	1000	TBD	Call TI	Call TI	-40 to 125	L71B	Samples
LM2937IMP-5.0/NOPB	ACTIVE	SOT-223	DCY	4	1000	Green (RoHS & no Sb/Br)	CU SN	Level-1-260C-UNLIM	-40 to 125	L71B	Samples
LM2937IMP-8.0	ACTIVE	SOT-223	DCY	4	1000	TBD	Call TI	Call TI	-40 to 125	L72B	Samples

Orderable Device	Status (1)	Package Type	Package Drawing	Pins	Package Qty	Eco Plan (2)	Lead/Ball Finish	MSL Peak Temp (3)	Op Temp (°C)	Top-Side Markings (4)	Samples
LM2937IMP-8.0/NOPB	ACTIVE	SOT-223	DCY	4	1000	Green (RoHS & no Sb/Br)	CU SN	Level-1-260C-UNLIM	-40 to 125	L72B	Samples
LM2937IMPX-10	ACTIVE	SOT-223	DCY	4	2000	TBD	Call TI	Call TI	-40 to 125	L73B	Samples
LM2937IMPX-10/NOPB	ACTIVE	SOT-223	DCY	4	2000	Green (RoHS & no Sb/Br)	CU SN	Level-1-260C-UNLIM	-40 to 125	L73B	Samples
LM2937IMPX-12	ACTIVE	SOT-223	DCY	4	2000	TBD	Call TI	Call TI	-40 to 125	L74B	Samples
LM2937IMPX-12/NOPB	ACTIVE	SOT-223	DCY	4	2000	Green (RoHS & no Sb/Br)	CU SN	Level-1-260C-UNLIM	-40 to 125	L74B	Samples
LM2937IMPX-15	ACTIVE	SOT-223	DCY	4	2000	TBD	Call TI	Call TI	-40 to 125	L75B	Samples
LM2937IMPX-15/NOPB	ACTIVE	SOT-223	DCY	4	2000	Green (RoHS & no Sb/Br)	CU SN	Level-1-260C-UNLIM	-40 to 125	L75B	Samples
LM2937IMPX-5.0	ACTIVE	SOT-223	DCY	4	2000	TBD	Call TI	Call TI	-40 to 125	L71B	Samples
LM2937IMPX-5.0/NOPB	ACTIVE	SOT-223	DCY	4	2000	Green (RoHS & no Sb/Br)	CU SN	Level-1-260C-UNLIM	-40 to 125	L71B	Samples
LM2937IMPX-8.0	ACTIVE	SOT-223	DCY	4	2000	TBD	Call TI	Call TI	-40 to 125	L72B	Samples
LM2937IMPX-8.0/NOPB	ACTIVE	SOT-223	DCY	4	2000	Green (RoHS & no Sb/Br)	CU SN	Level-1-260C-UNLIM	-40 to 125	L72B	Samples

(1) The marketing status values are defined as follows:

ACTIVE: Product device recommended for new designs.

LIFEBUY: TI has announced that the device will be discontinued, and a lifetime-buy period is in effect.

NRND: Not recommended for new designs. Device is in production to support existing customers, but TI does not recommend using this part in a new design.

PREVIEW: Device has been announced but is not in production. Samples may or may not be available.

OBSOLETE: TI has discontinued the production of the device.

(2) Eco Plan - The planned eco-friendly classification: Pb-Free (RoHS), Pb-Free (RoHS Exempt), or Green (RoHS & no Sb/Br) - please check <http://www.ti.com/productcontent> for the latest availability information and additional product content details.

TBD: The Pb-Free/Green conversion plan has not been defined.

Pb-Free (RoHS): TI's terms "Lead-Free" or "Pb-Free" mean semiconductor products that are compatible with the current RoHS requirements for all 6 substances, including the requirement that lead not exceed 0.1% by weight in homogeneous materials. Where designed to be soldered at high temperatures, TI Pb-Free products are suitable for use in specified lead-free processes.

Pb-Free (RoHS Exempt): This component has a RoHS exemption for either 1) lead-based flip-chip solder bumps used between the die and package, or 2) lead-based die adhesive used between the die and leadframe. The component is otherwise considered Pb-Free (RoHS compatible) as defined above.

Green (RoHS & no Sb/Br): TI defines "Green" to mean Pb-Free (RoHS compatible), and free of Bromine (Br) and Antimony (Sb) based flame retardants (Br or Sb do not exceed 0.1% by weight in homogeneous material)

⁽³⁾ MSL, Peak Temp. -- The Moisture Sensitivity Level rating according to the JEDEC industry standard classifications, and peak solder temperature.

⁽⁴⁾ Only one of markings shown within the brackets will appear on the physical device.

Important Information and Disclaimer: The information provided on this page represents TI's knowledge and belief as of the date that it is provided. TI bases its knowledge and belief on information provided by third parties, and makes no representation or warranty as to the accuracy of such information. Efforts are underway to better integrate information from third parties. TI has taken and continues to take reasonable steps to provide representative and accurate information but may not have conducted destructive testing or chemical analysis on incoming materials and chemicals. TI and TI suppliers consider certain information to be proprietary, and thus CAS numbers and other limited information may not be available for release.

In no event shall TI's liability arising out of such information exceed the total purchase price of the TI part(s) at issue in this document sold by TI to Customer on an annual basis.

TAPE AND REEL INFORMATION



QUADRANT ASSIGNMENTS FOR PIN 1 ORIENTATION IN TAPE



*All dimensions are nominal

Device	Package Type	Package Drawing	Pins	SPQ	Reel Diameter (mm)	Reel Width W1 (mm)	A0 (mm)	B0 (mm)	K0 (mm)	P1 (mm)	W (mm)	Pin1 Quadrant
LM2937ESX-12	DDPAK/TO-263	KTT	3	500	330.0	24.4	10.75	14.85	5.0	16.0	24.0	Q2
LM2937ESX-12/NOPB	DDPAK/TO-263	KTT	3	500	330.0	24.4	10.75	14.85	5.0	16.0	24.0	Q2
LM2937ESX-15	DDPAK/TO-263	KTT	3	500	330.0	24.4	10.75	14.85	5.0	16.0	24.0	Q2
LM2937ESX-15/NOPB	DDPAK/TO-263	KTT	3	500	330.0	24.4	10.75	14.85	5.0	16.0	24.0	Q2
LM2937ESX-5.0	DDPAK/TO-263	KTT	3	500	330.0	24.4	10.75	14.85	5.0	16.0	24.0	Q2
LM2937ESX-5.0/NOPB	DDPAK/TO-263	KTT	3	500	330.0	24.4	10.75	14.85	5.0	16.0	24.0	Q2
LM2937ESX-8.0	DDPAK/TO-263	KTT	3	500	330.0	24.4	10.75	14.85	5.0	16.0	24.0	Q2
LM2937ESX-8.0/NOPB	DDPAK/TO-263	KTT	3	500	330.0	24.4	10.75	14.85	5.0	16.0	24.0	Q2
LM2937IMP-10	SOT-223	DCY	4	1000	330.0	16.4	7.0	7.5	2.2	12.0	16.0	Q3
LM2937IMP-10/NOPB	SOT-223	DCY	4	1000	330.0	16.4	7.0	7.5	2.2	12.0	16.0	Q3
LM2937IMP-12	SOT-223	DCY	4	1000	330.0	16.4	7.0	7.5	2.2	12.0	16.0	Q3
LM2937IMP-12/NOPB	SOT-223	DCY	4	1000	330.0	16.4	7.0	7.5	2.2	12.0	16.0	Q3

Device	Package Type	Package Drawing	Pins	SPQ	Reel Diameter (mm)	Reel Width W1 (mm)	A0 (mm)	B0 (mm)	K0 (mm)	P1 (mm)	W (mm)	Pin1 Quadrant
LM2937IMP-5.0	SOT-223	DCY	4	1000	330.0	16.4	7.0	7.5	2.2	12.0	16.0	Q3
LM2937IMP-5.0/NOPB	SOT-223	DCY	4	1000	330.0	16.4	7.0	7.5	2.2	12.0	16.0	Q3
LM2937IMP-8.0	SOT-223	DCY	4	1000	330.0	16.4	7.0	7.5	2.2	12.0	16.0	Q3
LM2937IMP-8.0/NOPB	SOT-223	DCY	4	1000	330.0	16.4	7.0	7.5	2.2	12.0	16.0	Q3
LM2937IMPX-10	SOT-223	DCY	4	2000	330.0	16.4	7.0	7.5	2.2	12.0	16.0	Q3
LM2937IMPX-10/NOPB	SOT-223	DCY	4	2000	330.0	16.4	7.0	7.5	2.2	12.0	16.0	Q3
LM2937IMPX-12	SOT-223	DCY	4	2000	330.0	16.4	7.0	7.5	2.2	12.0	16.0	Q3
LM2937IMPX-12/NOPB	SOT-223	DCY	4	2000	330.0	16.4	7.0	7.5	2.2	12.0	16.0	Q3
LM2937IMPX-15	SOT-223	DCY	4	2000	330.0	16.4	7.0	7.5	2.2	12.0	16.0	Q3
LM2937IMPX-15/NOPB	SOT-223	DCY	4	2000	330.0	16.4	7.0	7.5	2.2	12.0	16.0	Q3
LM2937IMPX-5.0	SOT-223	DCY	4	2000	330.0	16.4	7.0	7.5	2.2	12.0	16.0	Q3
LM2937IMPX-5.0/NOPB	SOT-223	DCY	4	2000	330.0	16.4	7.0	7.5	2.2	12.0	16.0	Q3
LM2937IMPX-8.0	SOT-223	DCY	4	2000	330.0	16.4	7.0	7.5	2.2	12.0	16.0	Q3
LM2937IMPX-8.0/NOPB	SOT-223	DCY	4	2000	330.0	16.4	7.0	7.5	2.2	12.0	16.0	Q3

TAPE AND REEL BOX DIMENSIONS

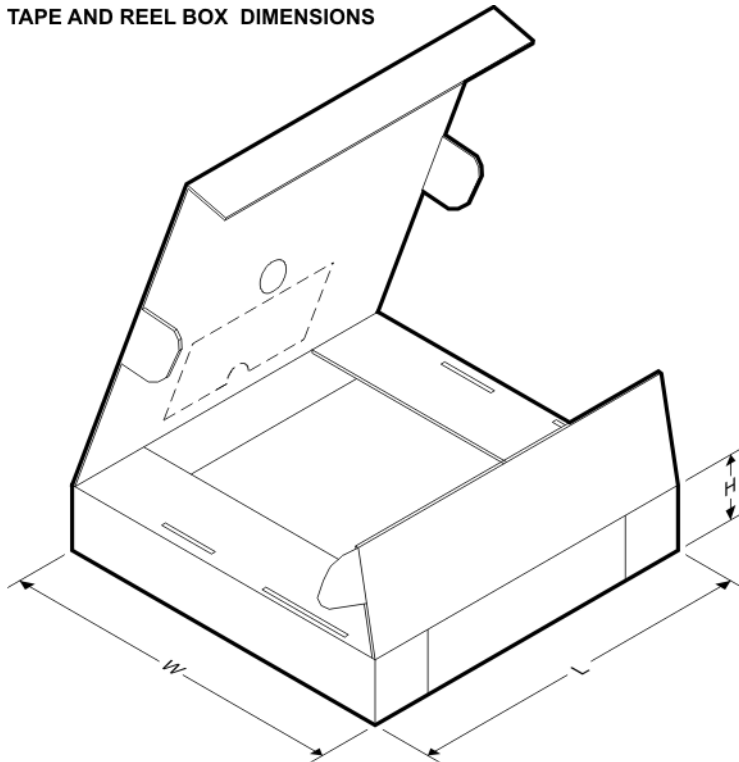

*All dimensions are nominal

Device	Package Type	Package Drawing	Pins	SPQ	Length (mm)	Width (mm)	Height (mm)
LM2937ESX-12	DDPAK/TO-263	KTT	3	500	358.0	343.0	63.0
LM2937ESX-12/NOPB	DDPAK/TO-263	KTT	3	500	358.0	343.0	63.0
LM2937ESX-15	DDPAK/TO-263	KTT	3	500	358.0	343.0	63.0

Device	Package Type	Package Drawing	Pins	SPQ	Length (mm)	Width (mm)	Height (mm)
LM2937ESX-15/NOPB	DDPAK/TO-263	KTT	3	500	358.0	343.0	63.0
LM2937ESX-5.0	DDPAK/TO-263	KTT	3	500	358.0	343.0	63.0
LM2937ESX-5.0/NOPB	DDPAK/TO-263	KTT	3	500	358.0	343.0	63.0
LM2937ESX-8.0	DDPAK/TO-263	KTT	3	500	358.0	343.0	63.0
LM2937ESX-8.0/NOPB	DDPAK/TO-263	KTT	3	500	358.0	343.0	63.0
LM2937IMP-10	SOT-223	DCY	4	1000	349.0	337.0	45.0
LM2937IMP-10/NOPB	SOT-223	DCY	4	1000	349.0	337.0	45.0
LM2937IMP-12	SOT-223	DCY	4	1000	349.0	337.0	45.0
LM2937IMP-12/NOPB	SOT-223	DCY	4	1000	349.0	337.0	45.0
LM2937IMP-5.0	SOT-223	DCY	4	1000	349.0	337.0	45.0
LM2937IMP-5.0/NOPB	SOT-223	DCY	4	1000	349.0	337.0	45.0
LM2937IMP-8.0	SOT-223	DCY	4	1000	349.0	337.0	45.0
LM2937IMP-8.0/NOPB	SOT-223	DCY	4	1000	349.0	337.0	45.0
LM2937IMPX-10	SOT-223	DCY	4	2000	354.0	340.0	35.0
LM2937IMPX-10/NOPB	SOT-223	DCY	4	2000	354.0	340.0	35.0
LM2937IMPX-12	SOT-223	DCY	4	2000	354.0	340.0	35.0
LM2937IMPX-12/NOPB	SOT-223	DCY	4	2000	354.0	340.0	35.0
LM2937IMPX-15	SOT-223	DCY	4	2000	354.0	340.0	35.0
LM2937IMPX-15/NOPB	SOT-223	DCY	4	2000	354.0	340.0	35.0
LM2937IMPX-5.0	SOT-223	DCY	4	2000	354.0	340.0	35.0
LM2937IMPX-5.0/NOPB	SOT-223	DCY	4	2000	354.0	340.0	35.0
LM2937IMPX-8.0	SOT-223	DCY	4	2000	354.0	340.0	35.0
LM2937IMPX-8.0/NOPB	SOT-223	DCY	4	2000	354.0	340.0	35.0

NDE0003B



DCY (R-PDSO-G4)

PLASTIC SMALL-OUTLINE



- NOTES: A. All linear dimensions are in millimeters (inches).
 B. This drawing is subject to change without notice.
 C. Body dimensions do not include mold flash or protrusion.
 D. Falls within JEDEC TO-261 Variation AA.

KTT0003B

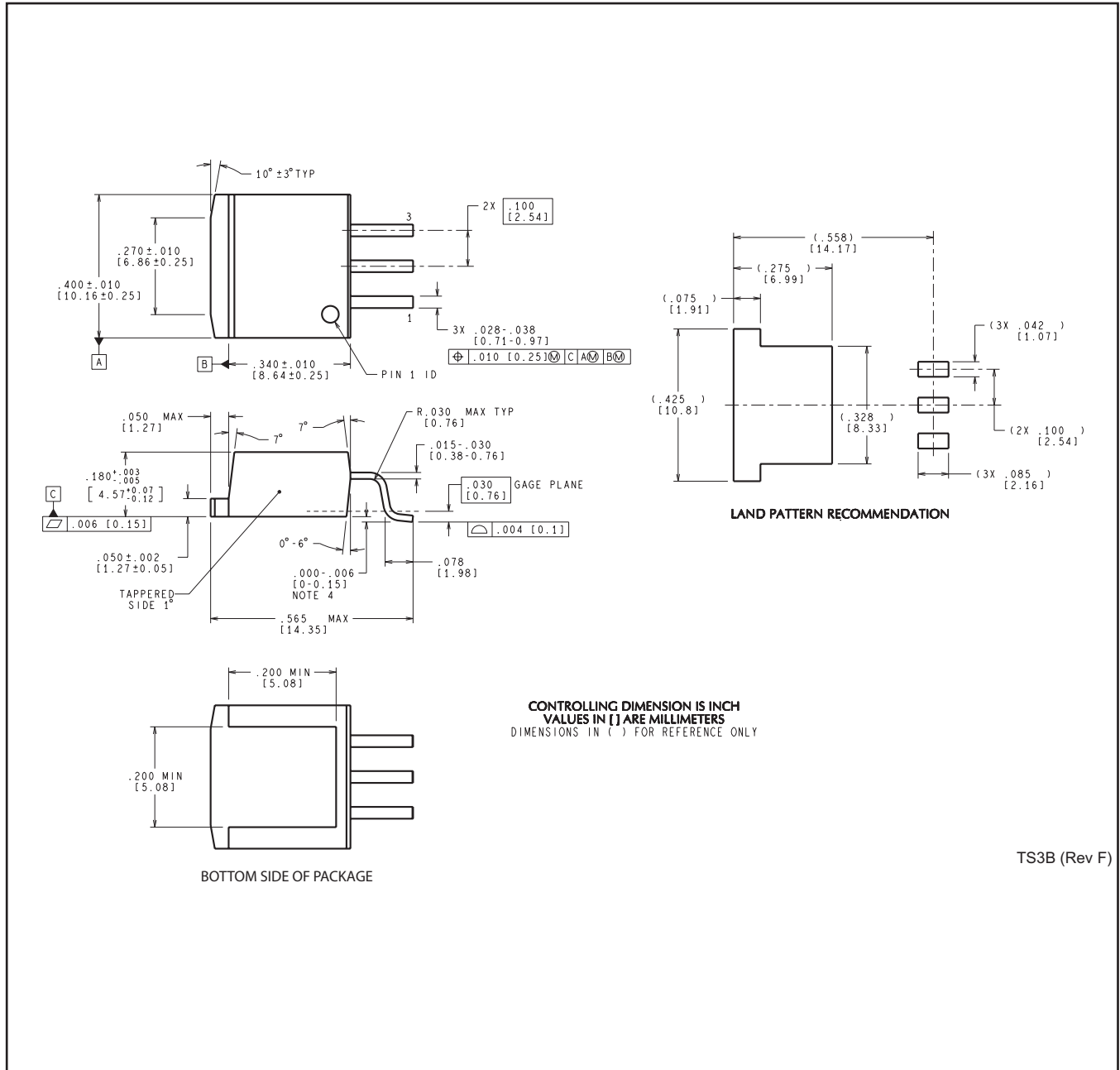

TS3B (Rev F)

IMPORTANT NOTICE

Texas Instruments Incorporated and its subsidiaries (TI) reserve the right to make corrections, enhancements, improvements and other changes to its semiconductor products and services per JESD46, latest issue, and to discontinue any product or service per JESD48, latest issue. Buyers should obtain the latest relevant information before placing orders and should verify that such information is current and complete. All semiconductor products (also referred to herein as "components") are sold subject to TI's terms and conditions of sale supplied at the time of order acknowledgment.

TI warrants performance of its components to the specifications applicable at the time of sale, in accordance with the warranty in TI's terms and conditions of sale of semiconductor products. Testing and other quality control techniques are used to the extent TI deems necessary to support this warranty. Except where mandated by applicable law, testing of all parameters of each component is not necessarily performed.

TI assumes no liability for applications assistance or the design of Buyers' products. Buyers are responsible for their products and applications using TI components. To minimize the risks associated with Buyers' products and applications, Buyers should provide adequate design and operating safeguards.

TI does not warrant or represent that any license, either express or implied, is granted under any patent right, copyright, mask work right, or other intellectual property right relating to any combination, machine, or process in which TI components or services are used. Information published by TI regarding third-party products or services does not constitute a license to use such products or services or a warranty or endorsement thereof. Use of such information may require a license from a third party under the patents or other intellectual property of the third party, or a license from TI under the patents or other intellectual property of TI.

Reproduction of significant portions of TI information in TI data books or data sheets is permissible only if reproduction is without alteration and is accompanied by all associated warranties, conditions, limitations, and notices. TI is not responsible or liable for such altered documentation. Information of third parties may be subject to additional restrictions.

Resale of TI components or services with statements different from or beyond the parameters stated by TI for that component or service voids all express and any implied warranties for the associated TI component or service and is an unfair and deceptive business practice. TI is not responsible or liable for any such statements.

Buyer acknowledges and agrees that it is solely responsible for compliance with all legal, regulatory and safety-related requirements concerning its products, and any use of TI components in its applications, notwithstanding any applications-related information or support that may be provided by TI. Buyer represents and agrees that it has all the necessary expertise to create and implement safeguards which anticipate dangerous consequences of failures, monitor failures and their consequences, lessen the likelihood of failures that might cause harm and take appropriate remedial actions. Buyer will fully indemnify TI and its representatives against any damages arising out of the use of any TI components in safety-critical applications.

In some cases, TI components may be promoted specifically to facilitate safety-related applications. With such components, TI's goal is to help enable customers to design and create their own end-product solutions that meet applicable functional safety standards and requirements. Nonetheless, such components are subject to these terms.

No TI components are authorized for use in FDA Class III (or similar life-critical medical equipment) unless authorized officers of the parties have executed a special agreement specifically governing such use.

Only those TI components which TI has specifically designated as military grade or "enhanced plastic" are designed and intended for use in military/aerospace applications or environments. Buyer acknowledges and agrees that any military or aerospace use of TI components which have **not** been so designated is solely at the Buyer's risk, and that Buyer is solely responsible for compliance with all legal and regulatory requirements in connection with such use.

TI has specifically designated certain components as meeting ISO/TS16949 requirements, mainly for automotive use. In any case of use of non-designated products, TI will not be responsible for any failure to meet ISO/TS16949.

Products

Audio	www.ti.com/audio
Amplifiers	amplifier.ti.com
Data Converters	dataconverter.ti.com
DLP® Products	www.dlp.com
DSP	dsp.ti.com
Clocks and Timers	www.ti.com/clocks
Interface	interface.ti.com
Logic	logic.ti.com
Power Mgmt	power.ti.com
Microcontrollers	microcontroller.ti.com
RFID	www.ti-rfid.com
OMAP Applications Processors	www.ti.com/omap
Wireless Connectivity	www.ti.com/wirelessconnectivity

Applications

Automotive and Transportation	www.ti.com/automotive
Communications and Telecom	www.ti.com/communications
Computers and Peripherals	www.ti.com/computers
Consumer Electronics	www.ti.com/consumer-apps
Energy and Lighting	www.ti.com/energy
Industrial	www.ti.com/industrial
Medical	www.ti.com/medical
Security	www.ti.com/security
Space, Avionics and Defense	www.ti.com/space-avionics-defense
Video and Imaging	www.ti.com/video

TI E2E Community

e2e.ti.com

Mouser Electronics

Authorized Distributor

Click to View Pricing, Inventory, Delivery & Lifecycle Information:

Texas Instruments:

[LM2937ES-8.0](#) [LM2937ESX-12](#) [LM2937ESX-15](#) [LM2937ESX-8.0](#) [LM2937IMP-8.0](#) [LM2937IMPX-15](#) [LM2937IMPX-5.0](#)